

IBM System Storage SAN384B-2



Installation, Service, and User Guide

Service information: 2499-416

Read Before Using

This product contains software that is licensed under written license agreements. Your use of such software is subject to the license agreements under which they are provided.

IBM System Storage SAN384B-2



Installation, Service, and User Guide

Service information: 2499-416

Note:

Before using this information and the product it supports, read the information in "Notices" on page 145.

Portions Copyright © 2011, 2012 Brocade Communications Systems, Inc. All Rights Reserved.

The following paragraph does not apply to any country (or region) where such provisions are inconsistent with local law.

INTERNATIONAL BUSINESS MACHINES CORPORATION PROVIDES THIS PUBLICATION "AS IS" WITHOUT WARRANTY OF ANY KIND, EITHER EXPRESS OR IMPLIED, INCLUDING, BUT NOT LIMITED TO, THE IMPLIED WARRANTIES OF MERCHANTABILITY OR FITNESS FOR A PARTICULAR PURPOSE. Some states (or regions) do not allow disclaimer of express or implied warranties in certain transactions; therefore, this statement may not apply to you.

© Copyright IBM Corporation 2011, 2012.

US Government Users Restricted Rights – Use, duplication or disclosure restricted by GSA ADP Schedule Contract with IBM Corp.

Read this first

Summary of changes

This is the fourth edition of the *IBM System Storage SAN384B-2 Installation, Service, and User Guide*. The content changes since the last edition of this publication are noted by a vertical line placed in the left margin beside each change. Minor edits are not identified by this mark. A summary of the changes for each edition are listed below.

Fourth edition

The following changes were made in this edition:

- Addition of Enhanced 8 Gbps 32-port blade—Feature code 3633
- Addition of Enhanced 8 Gbps 48-port blade—Feature code 3649
- Addition of FIPS tamper-proof seals—Feature code 7230
- Enhanced inter-chassis link (ICL) capability—Feature code 7872
- Updated Fabric OS version to 7.0.1 or higher

Third edition

The following changes were made in this edition:

- Addition of FICON Accelerator and FICON with CUP Activation optional features
- Updated FOS version to 7.0.0c
- Added port speed to Encryption blade information

Second edition

The following changes were made in the second edition:

- The addition of 16 Gbps long wave length (LWL) SFP feature
- The addition of encryption, including the Encryption Blade (FS8-18)
- Updated instructions on ordering the lift tool load plate (now included with the lift tool)
- Other minor content updates

Getting help

For the latest version of your product documentation, visit the web at www.ibm.com/shop/publications/order. Search by form number or title.

For more information about IBM® SAN products, see the following Web site: www.ibm.com/servers/storage/san/

IBM Redbooks® often provide in depth information about product best practices, configurations, and more technical information. For redbooks associated with this product, enter search terms on the following Web site: www.redbooks.ibm.com/.

For support information for this and other IBM products, see the IBM Support Portal, www.ibm.com/supportportal. Search for the product Machine type or product name.

For Fabric OS Release Notes and access to Fabric OS firmware downloads, go to the IBM Support Portal, www.ibm.com/supportportal. Search for the product Machine type or product name, and then follow links for **Downloads**. More detailed instructions are available through the **Accessing firmware updates and OS documentation updates** link on the product documentation CD that is shipped with this product.

You can also contact IBM Service within the United States at 1-800-IBMSERV (1-800-426-7378). For support outside the United States, you can find the service number at: www.ibm.com/planetwide/.

To expedite your call, before contacting IBM Service, please have the following information available:

- Machine type and model (2499-416)
- Product serial number
- License ID (you can use the `licenseIdShow` command to display the license ID)
- World Wide Name (WWN)
- FOS version installed
- Error numbers and messages received
- `supportSave` command output
- Detailed description of the problem and specific questions
- Description of any troubleshooting steps already performed and the results
- Serial console and Telnet session logs
- Syslog message logs

Visit www.ibm.com/contact for the contact information for your country or region.

For detailed information about the Fibre Channel standards, see the Fibre Channel Industry Association (FCIA) Web site at: www.fibrechannel.org/

For information about storage industry standards, see the Storage Networking Industry Association (SNIA) Web site at: www.snia.org/

Taiwan Contact Information

IBM Taiwan Product Service Contact Info:
IBM Taiwan Corporation
3F, No 7, Song Ren Rd., Taipei Taiwan
Tel: 0800-016-888

台灣IBM 產品服務聯絡方式：
台灣國際商業機器股份有限公司
台北市松仁路7號3樓
電話：0800-016-888

12-00790

How to send your comments

Your feedback is important in helping us provide the most accurate and high-quality information. If you have comments or suggestions for improving this document, send us your comments by e-mail to starpubs@us.ibm.com. Be sure to include the following:

- Exact publication title
- Publication form number (for example, GC26-1234-02)

- Page, table, or illustration numbers
- A detailed description of any information that should be changed

Contents

Read this first iii

Summary of changes	iii
Fourth edition	iii
Third edition	iii
Second edition	iii
Getting help	iii
Taiwan Contact Information	iv
How to send your comments	iv

Figures xi

Tables xiii

Safety notices xv

Safety notices and labels	xv
Danger notices	xv
Caution notices	xviii
Safety labels	xx
Attention notices	xxi
Rack safety	xxii
Rack installation	xxii
Rack relocation (19" rack)	xxiii
Safety inspections	xxiv
Removing AC power	xxiv
External machine checks	xxiv
Internal machine checks	xxiv
Product recycling and disposal	xxv

About this document xxvii

Who should read this document	xxvii
Product documents	xxvii
Brocade documents	xxvii
IBM and Brocade product matrix	xxviii
Accessibility features for SAN384B-2	xxviii

Chapter 1. Introduction 1

Overview of the SAN384B-2	1
Hardware components	2
SAN384B-2 blades	5
High availability	7
Reliability	8
Serviceability	8
Software features	9
Security	9
Network Manageability	10

Chapter 2. Installing a SAN384B-2 in a cabinet. 11

Items included with the SAN384B-2	11
Ordering the lift tool	12
World trade locations	12
United States locations	12
Installation guidelines	13
Installing a SAN384B-2 in a 2109 C36 cabinet	14

Time required	14
Unpacking and assembling the lift tool	16
Unpacking the SAN384B-2	17
Installing the port-side exhaust kit.	18
Torque requirements	21
Installing the exhaust kit hardware	21
Installing the SAN384B-2 into the cabinet	25
Port numbering	29
Chassis slots	31
Cable organization	31

Chapter 3. Starting and configuring the SAN384B-2 33

Providing power to the SAN384B-2	35
Connecting the SAN384B-2 and host with a serial cable	35
Logging in to the serial console port	36
Configuring the IP addresses	36
Logging off the serial console port and disconnecting the serial cable	38
Establishing an Ethernet connection	38
Customizing the switch name	38
Customizing a chassis name.	38
Setting the Domain ID.	39
Setting the date and time.	39
Setting the date	39
Setting the time zone	40
Synchronizing local time	40
Verifying the persistent PID feature	41
Determining installed software licenses	41
Installing transceivers and attaching cables	42
Managing cables.	44
Planning for encryption (optional).	45
Configuring for encryption (optional).	46
Summary of procedure	46
Avoid double encryption	47
Verifying correct operation and backing up the configuration	47
Fabric OS firmware updates	48
Downloading and installing firmware	49
Powering off the SAN384B-2	49

Chapter 4. Monitoring system components 51

Port, application, or encryption blade status	55
Control processor blade (CP8) status	59
Core switch blade (CR16-4) status	61
Power supply status	63
Blower assembly status	63
WWN card status	65

Chapter 5. Removing and installing components 67

Removing and installing the chassis door	67
--	----

Time and items required	67
Removing the chassis door	67
Removing and installing cable management finger assemblies	68
Time and items required	68
Removing a cable management finger assembly	68
Installing a cable management finger assembly	69
Removing and installing port, application, and encryption blades	70
Time and items required	70
Removing a port or application blade	70
Installing a blade	72
Removing and installing blade filler panels	72
Removing a filler panel	72
Installing a filler panel.	73
Removing and installing a CP8 control processor blade	73
Time and items required	74
Verifying the need for replacement	74
Recording critical SAN384B-2 information	75
Removing a control processor blade (CP8)	76
Installing a control processor blade (CP8)	77
Verifying operation of the new CP blade.	78
Downloading firmware from an FTP server.	78
Downloading firmware from a USB device.	80
Completing the CP8 blade replacement	81
Removing and installing a CR16-4 core switch blade	82
Verifying the necessity of replacement	82
Time and items required	82
Removing a CR16-4 core switch blade	83
Installing a CR16-4 core switch blade.	83
Removing and installing a power supply	84
Time and items required	84
Removing a power supply	84
Installing a power supply	86
Removing and installing a blower assembly	86
Time and items required	86
Removing a blower assembly	87
Installing a blower assembly.	87
Removing and installing a WWN bezel and WWN card	88
Time and items required	88
Verifying necessity of replacement.	88
Removing the WWN bezel and WWN card.	88
Installing the WWN bezel and WWN card	89
Removing and installing transceivers.	89
Time required	90
Items required	90
Removing and installing an SFP+ optical transceiver.	90
Removing and installing an mSFP optical transceiver.	92
Removing and replacing inter-chassis link (QSFP) cables	93
Time and items required	94
Removing an inter-chassis link (QSFP) cable	94
Installing an ICL cable.	94
Possible ICL configurations	95
Removing and replacing a SAN384B-2 chassis	98
Time required	99
Items required	99

Verifying need for replacement	99
Recording critical SAN384B-2 and SAN information	99
Disconnecting from the network and fabric	102
Removing components from the chassis	103
Removing a SAN384B-2 from the cabinet	104
Installing the replacement chassis	105
Installing components into the new chassis	105
Downloading the configuration	106
Verifying correct operation of system	107
Reconnecting the system to the network and fabric	108
Verifying correct configuration of the fabric	108
Cable routing table template	110
Removing the batteries	111

Chapter 6. Installing new features . . . 115

FC3632, FC3648- Installing a 16-Gb port blade (32 or 48 ports)	115
Time required	115
Items required	116
Procedures	116
FC3633, FC3649- Installing an Enhanced 8-Gb port blade (32 or 48 ports).	117
Time required	117
Items required	117
Procedures	117
FC3864 - Installing an 8-Gb 64-port port blade	118
Time required	118
Items required	118
Procedures	119
FC3890 - Installing an 8 Gbps Extension Blade (FX8-24)	120
Time required	120
Items required	120
Procedures	120
FC3895 - Installing an Encryption Blade (FS8-18)	121
Time required	121
Items required	122
Procedures	122
Avoid double encryption	123
FC7230 - Installing FIPS 140-2 Level 2 tamper proof seals	123
FC7871 - Installing a QSFP and inter-chassis license	123
Time required	123
Items required	123
Procedures	123
FC7872 - Installing a QSFP and Enterprise inter-chassis license	124
Time required	124
Items required	124
Procedures	124

Appendix A. Product specifications 125

General specifications	125
System architecture	125
System size and weights.	127
System blade and FRU weights	128
Facility requirements	128
Environmental requirements	129

Fibre Channel port specifications	129
Power specifications	130
Data transmission ranges	132
Power cords	132

Appendix B. Application and encryption blades 133

FS8-18 blade	133
FX8-24 blade	133

Appendix C. Diagnostics and troubleshooting 135

Obtaining chassis and component status	135
Interpreting POST and boot results	136
POST	136
Boot	137
Diagnostics	137
Troubleshooting	137

Appendix D. Port numbering 141

Notices 145

Trademarks	146
Electronic emission notices	146

Federal Communications Commission (FCC) Class A Statement	146
Industry Canada Class A Emission Compliance Statement	147
Avis de conformité à la réglementation d'Industrie Canada	147
European Union EMC Directive Conformance Statement	147
Germany Electromagnetic Compatibility Directive	147
People's Republic of China Class A Electronic Emission Statement	148
Japan Voluntary Control Council for Interference (VCCI) Class A Statement	149
Japan Electronics and Information Technology Industries Association (JEITA) Statement	149
Korea Communications Commission (KCC) Class A Statement	149
Russia Electromagnetic Interference (EMI) Class A Statement	149
Australia and New Zealand Class A Statement	149
Taiwan Class A Electronic Emission Statement	150

Index 151

Figures

1.	Port side of the SAN384B-2 (sample configuration)	3	28.	Power supply	63
2.	Port side of the SAN384B-2 with the exhaust kit installed (sample configuration)	4	29.	Blower assembly LEDs.	64
3.	Blower (non-port) side of the SAN384B-2	5	30.	WWN bezel	66
4.	Assembled lift tool with 24-inch load plate	17	31.	Chassis door	68
5.	Lift tool positioned next to the chassis on the shipping tray	18	32.	Cable management finger assemblies	69
6.	Port-side exhaust kit assembly for 27 to 31 in. (68.58 to 78.74 cm) cabinets	20	33.	Port, application, and encryption blade removal and installation (FC16-48 port blade shown)	71
7.	Clip and retainer nut locations on exhaust side cabinet rails (example showing relative positions)	22	34.	Filler panel removal and installation	73
8.	Shelf installed in cabinet	23	35.	Removing the control processor (CP8) blade	77
9.	Air duct installed into side slot in shelf	23	36.	Removing and replacing the core switch blade	83
10.	Installing the top rail assembly to the duct assembly and cabinet rails	24	37.	Location of the two power supplies	85
11.	Lift tool and chassis positioned at rear of cabinet	25	38.	Removing and installing a power supply	86
12.	Load plate extended inside the cabinet to the exhaust kit shelf	26	39.	Blower assembly removal and replacement	87
13.	Chassis half way into cabinet on load plate	27	40.	WWN bezel and card removal and installation	89
14.	Location of screws to attach the chassis to the cabinet rails	28	41.	Optical transceiver (SFP+) extraction tool	90
15.	Attaching the vertical cable management finger assemblies to the cabinet rails	29	42.	Installing and removing a 16 Gbps SFP+ with pull tab (shown without cable attached)	91
16.	Cable design for the mSFP patch cables for the FC8-64 high density port blade	32	43.	Removing and replacing an SFP+ optical transceiver	91
17.	Flow of configuration tasks for the SAN384B-2	34	44.	Optical mSFP transceiver	92
18.	Encryption configuration	47	45.	QSFP cable and transceiver	94
19.	FC16-32 port blade	55	46.	QSFP cable and transceiver (bail open)	94
20.	FC16-48 port blade	56	47.	QSFP cable connections for two SAN768B-2 chassis (sample configuration)	96
21.	FC8-32E port blade	56	48.	Core/edge ICL topology for SAN384B-2 and SAN768B-2 chassis	97
22.	FC8-48E port blade	56	49.	full mesh ICL topology for SAN384B-2 and SAN768B-2 chassis	98
23.	FC8-64 port blade	57	50.	Battery locations on the CP8 blade	112
24.	FS8-18 encryption blade	57	51.	Encryption blade battery location	113
25.	FX8-24 extension blade.	58	52.	CR16-4 core blade	141
26.	Control processor blade (CP8) ports and LEDs	60	53.	FC16-32 port blade.	142
27.	Core switch blade (CR16-4)	61	54.	FC16-48 port blade.	142
			55.	FC8-32E port blade	142
			56.	FC8-48E port blade	143
			57.	FC8-64 port blade	143
			58.	FS8-18 encryption blade	143
			59.	FX8-24 extension blade	143

Tables

1. Brocade and IBM product and model number matrix	xxviii	15. ICL connector port LEDs	93
2. Blades available for the SAN384B-2	5	16. Critical information checklist example	100
3. Installation tasks, time, and items required	15	17. Cable routing table for SAN384B-2 (64 ports shown).	110
4. Parts list for port-side exhaust kit for C36 cabinets	19	18. General product specifications	125
5. Torque requirements for mounting screws	21	19. System architecture	125
6. Port and application blades available on the SAN384B-2.	29	20. System sizes and weights	127
7. Configuration parameters	36	21. System FRU weights	128
8. Port, application, and encryption blade LED descriptions	58	22. Environmental requirements	129
9. CP blade LED descriptions	60	23. Power specifications	130
10. CR16-4 blade LED descriptions	62	24. Power demands per component	131
11. Power supply LED descriptions.	63	25. Supported optics, speeds, cables, and distances	132
12. Blower assembly LED descriptions.	64	26. Environmental status and maintenance commands	136
13. Messages that may indicate WWN card failure	65	27. Troubleshooting.	137
14. Steps for upgrading through multiple versions of Fabric OS	78	28. External port to slotShow port mapping for CR16-4 core blades.	141

Safety notices

This section contains information about:

- “Safety notices and labels”
- “Rack safety” on page xxii
- “Safety inspections” on page xxiv

Safety notices and labels

When using this product, observe the danger, caution, and attention notices contained in this guide. The notices are accompanied by symbols that represent the severity of the safety condition. The danger and caution notices are listed in numerical order based on their IDs, which are displayed in parentheses, for example (D004), at the end of each notice. Use this ID to locate the translation of these danger and caution notices in the *IBM System Storage SAN b-type Safety Notices* publication, which is shipped with this product.

The following notices and statements are used in IBM documents. They are listed below in order of increasing severity of potential hazards. Follow the links for more detailed descriptions and examples of the danger, caution, and attention notices in the sections that follow.

- **Note:** These notices provide important tips, guidance, or advice.
- **“Attention notices” on page xxi:** These notices indicate potential damage to programs, devices, or data.
- **“Caution notices” on page xviii:** These statements indicate situations that can be potentially hazardous to you.
- **“Danger notices”:** These statements indicate situations that can be potentially lethal or extremely hazardous to you. Safety labels are also attached directly to products to warn of these situations.
- In addition to these notices, “Safety labels” on page xx may be attached to the product to warn of potential hazards.

Danger notices

A danger notice calls attention to a situation that is potentially lethal or extremely hazardous to people. A lightning bolt symbol accompanies a danger notice to represent a dangerous electrical condition. Read and comply with the following danger notices before installing or servicing this device.



DANGER

To prevent a possible shock from touching two surfaces with different protective ground (earth), use one hand, when possible, to connect or disconnect signal cables. (D001)



DANGER

Overloading a branch circuit is potentially a fire hazard and a shock hazard under certain conditions. To avoid these hazards, ensure that your system electrical requirements do not exceed branch circuit protection requirements. Refer to the information that is provided with your device or the power rating label for electrical specifications. (D002)



DANGER

If the receptacle has a metal shell, do not touch the shell until you have completed the voltage and grounding checks. Improper wiring or grounding could place dangerous voltage on the metal shell. If any of the conditions are not as described, STOP. Ensure the improper voltage or impedance conditions are corrected before proceeding. (D003)



DANGER

An electrical outlet that is not correctly wired could place hazardous voltage on metal parts of the system or the devices that attach to the system. It is the responsibility of the customer to ensure that the outlet is correctly wired and grounded to prevent an electrical shock. (D004)

A general electrical danger notice provides instructions on how to avoid shock hazards when servicing equipment. Unless instructed otherwise, follow the procedures in the following danger notice.



DANGER

When working on or around the system, observe the following precautions:

Electrical voltage and current from power, telephone, and communication cables are hazardous. To avoid a shock hazard:

- Connect power to this unit only with the IBM provided power cord. Do not use the IBM provided power cord for any other product.
- Do not open or service any power supply assembly.
- Do not connect or disconnect any cables or perform installation, maintenance, or reconfiguration of this product during an electrical storm.
- The product might be equipped with multiple power cords. To remove all hazardous voltages, disconnect all power cords.
- Connect all power cords to a properly wired and grounded electrical outlet. Ensure that the outlet supplies proper voltage and phase rotation according to the system rating plate.
- Connect any equipment that will be attached to this product to properly wired outlets.
- When possible, use one hand only to connect or disconnect signal cables.
- Never turn on any equipment when there is evidence of fire, water, or structural damage.
- Disconnect the attached power cords, telecommunications systems, networks, and modems before you open the device covers, unless instructed otherwise in the installation and configuration procedures.
- Connect and disconnect cables as described below when installing, moving, or opening covers on this product or attached devices.

To Disconnect:

1. Turn off everything (unless instructed otherwise).
2. Remove the power cords from the outlets.
3. Remove the signal cables from the connectors.
4. Remove all cables from the devices.

To Connect:

1. Turn off everything (unless instructed otherwise).
2. Attach all cables to the devices.
3. Attach the signal cables to the connectors.
4. Attach the power cords to the outlets.
5. Turn on the devices.

(D005)

The weight of the SAN cabinet (2109-C36) with two SAN384B-2s is greater than 227 kg (500 lb), and has a fully loaded capacity of 816 kg (1795 lb). Under these conditions, the following statement and notice apply.

Delivery and subsequent transportation of the equipment

The customer should prepare his environment to accept the new product based on the installation planning information provided, with assistance from an IBM Installation Planning Representative (IPR) or IBM authorized service provider. In anticipation of the equipment delivery, the final installation site should be prepared in advance such that professional movers/riggers can transport the equipment to the final installation site within the computer room. If for some reason, this is not possible at the time of delivery, the customer will need to make arrangements to have professional movers/riggers return to finish the transportation at a later date. Only professional movers/riggers should transport the equipment. The IBM authorized service provider will only perform minimal frame repositioning within the computer room, as needed, to perform required service actions. The customer is also responsible for using professional movers/riggers in the case of equipment relocation or disposal.



DANGER

Heavy equipment—personal injury or equipment damage might result if mishandled. (D006)

Caution notices

A caution notice calls attention to a situation that is potentially hazardous to people because of some existing condition. A caution notice can be accompanied by different symbols, as in the examples below:

If the symbol is...	It means....
	A hazardous electrical condition with less severity than electrical danger.
	A generally hazardous condition not represented by other safety symbols.
 >55kg (121.2 lb)	A specification of product weight that requires safe lifting practices. The weight range of the product is listed below the graphic, and the wording of the caution varies, depending on the weight of the device.
	A potential hazard of pinching the hand or other body parts between parts.
	A hazardous condition due to moving parts nearby.
	A hazardous condition due to the use of a laser in the product. Laser symbols are always accompanied by the classification of the laser as defined by the U.S. Department of Health and Human Services (for example, Class I, Class II, and so forth).

Read and comply with the following caution notices before installing or servicing this device.



CAUTION:

Energy hazard present. Shorting may result in system outage and possible physical injury. Remove all metallic jewelry before servicing. (C001)

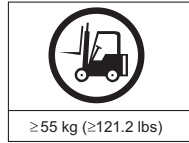

svc00169

CAUTION:

The weight of this part or unit is more than 55 kg (121.2 lb). It takes specially trained persons, a lifting device, or both to safely lift this part or unit. (C011)

>55kg (121.2 lb)



CAUTION:

The system contains circuit cards, assemblies, or both that may contain lead solder. To avoid the release of lead (Pb) into the environment, do not burn. Discard the circuit card as instructed by local regulations. (C014)



CAUTION:

This product is equipped with a 3-wire (two conductors and ground) power cable and plug. Use this power cable with a properly grounded electrical outlet to avoid electrical shock. (C018)



Class I

CAUTION:

This product might contain one or more of the following devices: CD-ROM drive, DVD-ROM drive, DVD-RAM drive, or laser module, which are Class 1 laser products. Note the following information:

- Do not remove the covers. Removing the covers of the laser product could result in exposure to hazardous laser radiation. There are no serviceable parts inside the device.
- Use of the controls or adjustments or performance of procedures other than those specified herein might result in hazardous radiation exposure.

(C026)



CAUTION:

The power-control button on the device does not turn off the electrical current supplied to the device. The device might also have more than one connection to dc power. To remove all electrical current from the device, ensure that all connections to dc power are disconnected at the dc power input terminals. (C031)



CAUTION:

Servicing of this product or unit is to be performed by trained service personnel only. (C032)

CAUTION:

For CA residents only: IBM recommends installing this product in a room size of 62 cubic meters (2190 cubic feet) or larger at 0.4 ACH ventilation rate to reduce the concentrations of any chemicals emitted by the product.

Safety labels

As an added precaution, safety labels are often installed directly on products or product components to warn of potential hazards. These can be either danger or caution notices, depending upon the level of the hazard.

The actual product safety labels may differ from these sample safety labels:



DANGER

Hazardous voltage, current, or energy levels are present inside any component that has this label attached. Do not open any cover or barrier that contains this label. (L001)



DANGER

Rack-mounted devices are not to be used as a shelf or work space. (L002)

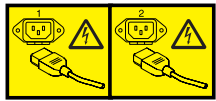

DANGER

Multiple power cords. The product might be equipped with multiple power cords. To remove all hazardous voltages, disconnect all power cords. (L003)



DANGER

Hazardous voltage present. Voltages present constitute a shock hazard, which can cause severe injury or death. (L004)



CAUTION:

Hazardous energy present. Voltages with hazardous energy might cause heating when shorted with metal, which might result in splattered metal, burns, or both. (L005)



CAUTION:

Hazardous moving parts nearby (L008)



CAUTION:
Pinch hazard. (L012)

Attention notices

An attention notice indicates the possibility of damage to a program, device, or system, or to data. An exclamation point symbol may accompany an attention notice, but is not required. A sample attention notice follows:

Attention: Do not bend a fibre cable to a radius less than 5 cm (2 in.); you can damage the cable. Tie wraps are not recommended for optical cables because they can be easily overtightened, causing damage to the cable.

ESD precautions

Attention: Many of the field replaceable units (FRUs) are sensitive to electrostatic discharge (ESD), and can potentially be damaged by improper handling. Wear a wrist grounding strap connected to chassis ground (if the SAN384B-2 is plugged in) or a bench ground. Store all ESD-sensitive components in antistatic packaging.

Rack safety

Rack installation

DANGER

Observe the following precautions when working on or around your IT rack system:

- Heavy equipment—personal injury or equipment damage might result if mishandled.
- Always lower the leveling pads on the rack cabinet.
- Always install stabilizer brackets on the rack cabinet.
- To avoid hazardous conditions due to uneven mechanical loading, always install the heaviest devices in the bottom of the rack cabinet. Always install servers and optional devices starting from the bottom of the rack cabinet.
- Rack-mounted devices are not to be used as shelves or work spaces. Do not place objects on top of rack-mounted devices.



- Each rack cabinet might have more than one power cord. Be sure to disconnect all power cords in the rack cabinet when directed to disconnect power during servicing.
- Connect all devices installed in a rack cabinet to power devices installed in the same rack cabinet. Do not plug a power cord from a device installed in one rack cabinet into a power device installed in a different rack cabinet.
- An electrical outlet that is not correctly wired could place hazardous voltage on the metal parts of the system or the devices that attach to the system. It is the responsibility of the customer to ensure that the outlet is correctly wired and grounded to prevent an electrical shock.

(R001 part 1 of 2)

CAUTION:

- Do not install a unit in a rack where the internal rack ambient temperatures will exceed the manufacturer's recommended ambient temperature for all your rack-mounted devices.
- Do not install a unit in a rack where the air flow is compromised. Ensure that air flow is not blocked or reduced on any side, front, or back of a unit used for air flow through the unit.
- Consideration should be given to the connection of the equipment to the supply circuit so that overloading of the circuits does not compromise the supply wiring or overcurrent protection. To provide the correct power connection to a rack, refer to the rating labels located on the equipment in the rack to determine the total power requirement of the supply circuit.
- *(For sliding drawers)* Do not pull out or install any drawer or feature if the rack stabilizer brackets are not attached to the rack. Do not pull out more than one drawer at a time. The rack might become unstable if you pull out more than one drawer at a time.
- *(For fixed drawers)* This drawer is a fixed drawer and must not be moved for servicing unless specified by the manufacturer. Attempting to move the drawer partially or completely out of the rack might cause the rack to become unstable or cause the drawer to fall out of the rack.

(R001 part 2 of 2)

Rack relocation (19" rack)

CAUTION:

Removing components from the upper positions in the rack cabinet improves rack stability during relocation. Follow these general guidelines whenever you relocate a populated rack cabinet within a room or building:

- Reduce the weight of the rack cabinet by removing equipment starting at the top of the rack cabinet. When possible, restore the rack cabinet to the configuration of the rack cabinet as you received it. If this configuration is not known, you must do the following:
 - Remove all devices in the 32U position and above.
 - Ensure that the heaviest devices are installed in the bottom of the rack cabinet.
 - Ensure that there are no empty U-levels between devices installed in the rack cabinet below the 32U level.
 - If the rack cabinet you are relocating is part of a suite of rack cabinets, detach the rack cabinet from the suite.
 - Inspect the route that you plan to take when moving the rack to eliminate potential hazards.
 - Verify that the route that you choose can support the weight of the loaded rack cabinet. Refer to the documentation that came with your rack cabinet for the weight of a loaded rack cabinet.
 - Verify that all door openings are at least 760 x 2030 mm (30 x 80 in.).
 - Ensure that all devices, shelves, drawers, doors, and cables are secure.
 - Ensure that the four leveling pads are raised to their highest position.
 - Ensure that there is no stabilizer bracket installed on the rack cabinet during movement.
 - Do not use a ramp inclined at more than 10 degrees.
 - Once the rack cabinet is in the new location, do the following:
 - Lower the four leveling pads.
 - Install stabilizer brackets on the rack cabinet.
 - If you removed any devices from the rack cabinet, repopulate the rack cabinet from the lowest position to the highest position.
 - If a long distance relocation is required, restore the rack cabinet to the configuration of the rack cabinet as you received it. Pack the rack cabinet in the original packaging material, or equivalent. Also, lower the leveling pads to raise the casters off of the pallet and bolt the rack cabinet to the pallet.

(R002)

Safety inspections

Perform the following safety checks to identify unsafe conditions. Be cautious of potential safety hazards that are not covered in the safety checks. If unsafe conditions are present, determine how serious the hazards are and whether you should continue before you correct the problem.

Removing AC power

Perform the following steps to remove the alternating current (ac) power:

1. Perform a controlled system shutdown.
2. Set the power switch on the product to the off position.
3. Disconnect the power cables from the power source.

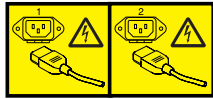

DANGER

Multiple power cords. (L003)

External machine checks

Perform the following external machine checks:

1. Verify that all external covers are present and are not damaged.
2. Ensure that all latches and hinges are in correct operating condition.
3. Check the power cable for damage.
4. Check the external signal cable for damage.
5. Check the cover for sharp edges, damage, or alterations that expose the internal parts of the device.
6. Check that any unused serial ports are covered for dust and ESD protection. The cover should be kept on the serial port whenever it is not being used.
7. Correct any problems that you find.

Internal machine checks

Perform the following internal machine checks:

1. Check for any non-IBM changes that might have been made to the machine. If any are present, obtain the "Non-IBM Alteration Attachment Survey" form, number R009, from the IBM branch office. Complete the form and return it to the branch office.
2. Check the condition of the inside of the machine for:
 - Metal or other contaminants
 - Indications of water or other fluid
 - Fire or smoke damage
3. Check for any obvious mechanical problems, such as loose components.
4. Check any exposed cables and connectors for wear, cracks, or pinching.

Product recycling and disposal

Refer to the *IBM Systems Environmental Notices and User Guide (Z125-5823)* on the CD shipped with the product for translated environmental statements and information regarding product recycling and disposal. This document may be provided either in printed version or on a CD-ROM. See “Removing the batteries” on page 111 for battery removal instructions, if needed to meet environmental regulations.

About this document

This document describes how to install and service the IBM System Storage® SAN384B-2 fabric backbone product (Machine type 2499-416). Throughout this document, the product is referred to as the *SAN384B-2*, or more generically as *system*, *device*, or *chassis*, where appropriate. This document includes information specific to the SAN384B-2 running Fabric OS version 7.0.1 and later. For information about a Fabric OS version other than 7.0.1, refer to the documentation specific to your Fabric OS version.

The sections that follow provide information about:

- “Who should read this document”
- “Product documents”
- “Brocade documents”
- “Accessibility features for SAN384B-2” on page xxviii

Who should read this document

This document is intended for trained service representatives who are responsible for installing and servicing the SAN384B-2, and for network administrators responsible for maintaining and using the SAN384B-2.

Product documents

The following documents contain information related to this product. The documentation may be printed material, on the documentation CD that is shipped with the product, or available on the web through the IBM Support Portal or IBM Publications Center.

- *IBM System Storage SAN384B-2 Installation, Service, and User Guide*, GA32-0894 (this document, which is also available in accessible HTML format on the documentation CD)
- *IBM System Storage SAN b-type Safety Notices*
- *IBM Systems Environmental Notices and User Guide*, Z125-5823
- IBM Warranty
- *Implementing an IBM/Brocade SAN with 8 Gbps Directors and Switches*, (an IBM Redbook), SG24-6116

Note: This publication was written for earlier products, but many of the practices still apply.

- *IBM System Storage FIPS 140-2 Security Seal Application Procedures* (GA32-2220-00), available online only for this optional feature.

Brocade documents

IBM switches and directors use software licensed from Brocade Communications Systems, Inc. You can find information related to the software that supports the SAN384B-2 in the following documents on the CD-ROM supplied with this product. More recent versions of the Fabric Operating System (FOS) documentation may be available to match the version of FOS that you have installed. The

publication CD includes information on how to locate and download the latest versions of FOS documentation and firmware updates.

Brocade Fabric OS

- *Fabric OS Administrator's Guide*
- *Fabric OS Command Reference Manual*
- *Fabric OS MIB Reference*
- *Fabric OS Message Reference*
- *Fabric OS Troubleshooting and Diagnostics Guide*
- *Fabric OS FCIP Administrator's Guide*
- *Fabric OS Encryption Administrator's Guide Supporting Tivoli Key Lifecycle Manager (TKLM) Environments*
- *FICON Administrator's Guide*

Brocade Fabric OS optional features

- *Fabric Watch Administrator's Guide*
- *Web Tools Administrator's Guide*

IBM and Brocade product matrix

When you use any of the Brocade documents, such as Fabric Operating System (FOS) publications, you will notice that the model numbers reflect the corresponding Brocade products. Table 1 provides a product matrix for you to use to correlate the Brocade products and models to the IBM product names and machine types and model numbers. Products withdrawn from marketing are not listed.

Table 1. Brocade and IBM product and model number matrix

Brocade product name	IBM product name	IBM machine type and model number
Brocade 6505	SAN24B-5	2498 Model F24, 249824G
Brocade 6510	SAN48B-5	2498 Model F48
Brocade DCX 8510-4	SAN384B-2	2499 Model 416
Brocade DCX 8510-8	SAN768B-2	2499 Model 816
Brocade DCX-4S	SAN384B	2499 Model 192
Brocade DCX	SAN768B	2499 Model 384
Brocade Encryption Switch	SAN32B-E4	2498 Model E32
Brocade 8000	IBM Converged Switch B32	3758 Models B32 and L32
Brocade 7800	SAN06B-R	2498 Model R06
Brocade 5300	SAN80B-4	2498 Model B80
Brocade 5100	SAN40B-4	2498 Models B40 and 40E
Brocade 300	SAN24B-4	2498 Models B24 and 24E

Accessibility features for SAN384B-2

Accessibility features help users who have a disability, such as restricted mobility or limited vision, to use information technology products successfully.

Accessibility features

Use and operation of this device is accomplished primarily through external devices which may provide different accessibility features.

The following list includes the major accessibility features in the SAN384B-2 either directly or through external devices or interfaces:

- Keyboard-only operation
- Interfaces that are commonly used by screen readers
- Keys that are discernible by touch but do not activate just by touching them
- Industry-standard devices for ports and connectors
- The attachment of alternative input and output devices

Keyboard navigation

This product uses standard Microsoft Windows navigation keys.

Vendor software

The SAN384B-2 includes certain vendor software that is not covered under the IBM license agreement. IBM makes no representation about the accessibility features of these products. Contact the vendor for the accessibility information about its products.

Related accessibility information

You can view the publications for the SAN384B-2 in Adobe Portable Document Format (PDF) using the Adobe Acrobat Reader. The PDFs are provided on a CD that is packaged with the product. An accessible HTML version of this document is also included on the documentation CD for this product.

IBM and accessibility

See the IBM Human Ability and Accessibility Center for more information about the commitment that IBM has to accessibility: www.ibm.com/able.

Chapter 1. Introduction

This chapter introduces the features and components of the IBM System Storage SAN384B-2 fabric backbone. Throughout this document, the product is referred to as the *SAN384B-2*, or more generically as *system*, *device*, or *chassis*, where appropriate. This chapter contains the following information:

- “Overview of the SAN384B-2”
- “Hardware components” on page 2
- “High availability” on page 7
- “Reliability” on page 8
- “Serviceability” on page 8
- “Software features” on page 9

Overview of the SAN384B-2

The SAN384B-2 is part of IBM's industry-leading backbone-class product line, a highly robust class of network switching platform that combines breakthrough performance, scalability, and energy efficiency with long-term investment. Supporting open systems and System z[®], SAN backbones are designed to address the data growth and application demands of evolving enterprise data centers, achieve server, SAN, and data center consolidation, and reduce infrastructure and administrative costs. The IBM backbone-class product line provides the most reliable, scalable, high performance foundation for private cloud storage and highly virtualized environments. They are designed to increase business agility by adapting to dynamic growth and change, providing non-stop access to information, and reducing infrastructure and administrative costs.

Key features of the SAN384B-2 include:

- Up to 192 16-Gbps external ports in a single chassis, enabling high density SAN configurations with reduced footprint.
- Support for 2, 4, 8, and 16 Gbps auto-sensing Fibre Channel ports. Trunking technology groups up to eight ports to create high performance 64-Gbps ISL trunks between switches.
- The chassis also supports 10 Gbps FC-type SFPs in 16 Gbps port blades only and also supports 10 GbE SFPs in the FX8-24 extension blades. These two types of SFPs are not interchangeable.
- The 10 Gbps ports can be configured manually on only the first eight ports of the 16 Gbps port blades.
- Support for all of the application, port blade, and control processor (CP) blades supported in the SAN768B-2 (with the exception of the Core Switch Blade), providing flexible system configurations and fewer types of new blades.
- Beginning with Fabric OS v7.0.1, up to nine chassis can be connected with the use of 4x16 Gbps quad SFP (QSFP) inter-chassis links (ICLs). Fabric OS v7.0.0 permits up to six chassis to be linked.
- Support for high-performance port blades running at 2, 4, 8, 10, or 16 Gbps, enabling flexible system configuration.

- Redundant and hot-swappable control processor and core switch blades, power supplies, blower assemblies, and WWN cards that enable a high availability platform and enable nondisruptive software upgrades for mission-critical SAN applications.
- Universal ports that self-configure as E_Ports, F_Ports, EX_Ports and M_Ports (mirror ports). 10 Gbps ports are E_Ports only.
- Diagnostic port (D_Port) functionality.
- In-flight data cryptographic (encryption/decryption) and data compression capabilities through the 16 Gbps port blades.
- Fibre Channel over IP (FCIP) functionality through the FX8-24 blade.

Attention: This product is not intended to be connected directly or indirectly by any means whatsoever to interfaces of public telecommunications networks.

Hardware components

The SAN384B-2 features a modular and scalable mechanical construction that allows a wide range of flexibility in installation, fabric design, and maintenance. The chassis may be mounted with the cables facing the front of the equipment rack or to the rear, and consists of the following:

- Up to four hot-swappable port blade assemblies can be configured in a single chassis, delivering up to 192 16-Gbps Fibre Channel ports
- Two slots for control processor blades (CP8):
 - A single active CP8 blade can control all 192 ports in the chassis.
 - The standby CP8 blade assumes control of the SAN384B-2 if the active CP fails
- Two slots for core switch blades (CR16-4):
 - CR16-4 blade interconnects all port blades
 - Inter-chassis link (ICL) connectors to connect to as many as nine neighboring chassis (with FOS 7.0.1). Six chassis can be connected with FOS v7.0.0.
 - Both CR16-4 blades are active
- Modular hot-swappable port blades:
 - 64-port, 8-Gbps blades (FC8-64)
 - 32-port, 8-Gbps blades (FC8-32E)
 - 48-port, 8-Gbps blades (FC8-48E)
 - 32-port, 16-Gbps blades (FC16-32)
 - 48-port, 16-Gbps blades (FC16-48)
- Modular hot-swappable application blades:
 - FX8-24: 24-port (12 FC, 10 GbE, 2 10GbE) FCIP extension blade enabling long distance communication over existing IP infrastructure.
- Modular hot-swappable encryption blades:
 - FS8-18: 16-port, 8 Gbps, up to 4 blades per chassis, supporting in-flight data cryptographic (encryption/decryption) and data-compression capabilities.
- Modular hot-swappable field replaceable units (FRUs):
 - Two blower assemblies
 - Two power supplies (100-240 VAC auto-sensing). 220 VAC (nominal) is recommended for efficiency. A second power supply, connected to a separate power source is needed to support high availability
 - Two WWN cards

- Blades use small form-factor pluggable (SFP+, and mSFP) optical transceivers. SFP+ and mSFP transceivers support speeds of 2, 4, 8, 10, or 16 Gbps.

Note: The 8-Gbps SFP+s and mSFPs auto-negotiate at 2, 4, and 8 Gbps. The 16-Gbps SFP+s auto-negotiate at 4, 8, and 16 Gbps. The 10 Gbps speeds must be manually set and require special 10 Gbps SFP+ transceivers.

- QSFP-based inter-chassis link (ICL) cabling running at 64 Gbps (four 16 Gbps clustered in a single quad connector and cable).
- Port-side exhaust kit (standard), which directs the exhaust airflow to the cabinet service aisle
- All blades are serviced from the port side of the SAN384B-2. Blowers, power supplies, and power cables are serviced from the nonport side
- World Wide Name (WWN) cards on the nonport side, with WWN status LEDs located under the bezel
- Two vertical cable management finger assemblies and a chassis door provide for efficient cable management.

Note: Airflow in the SAN384B-2 is from the non-port (non-cable) side to the left side and port side of the chassis. With the port-side exhaust kit installed (see Figure 2 on page 4, all air flows out the vents on the port side of the chassis. Figure 1 shows a sample configuration of the port side of the SAN384B-2 with four FC8-48 port blades installed.

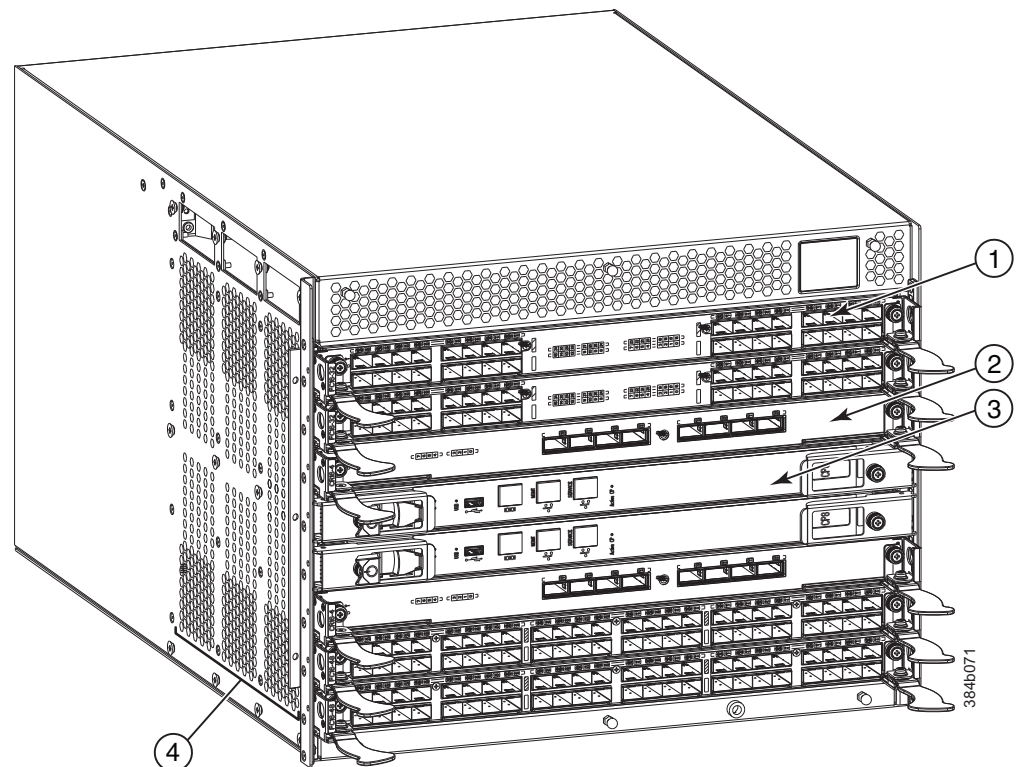

Figure 1. Port side of the SAN384B-2 (sample configuration)

- | | | | |
|----------|--------------------------|----------|------------------------------|
| 1 | Port blade (example, 4x) | 3 | Control processor blade (2x) |
| 2 | Core switch blade (2x) | 4 | Exhaust vent |

Figure 2 shows the SAN384B-2 with the port-side exhaust kit installed over the chassis exhaust vent (sample configuration). The exhaust is routed from the chassis exhaust vent through the port-side exhaust kit. The exhaust from the left side exits through the vent grill below the chassis.

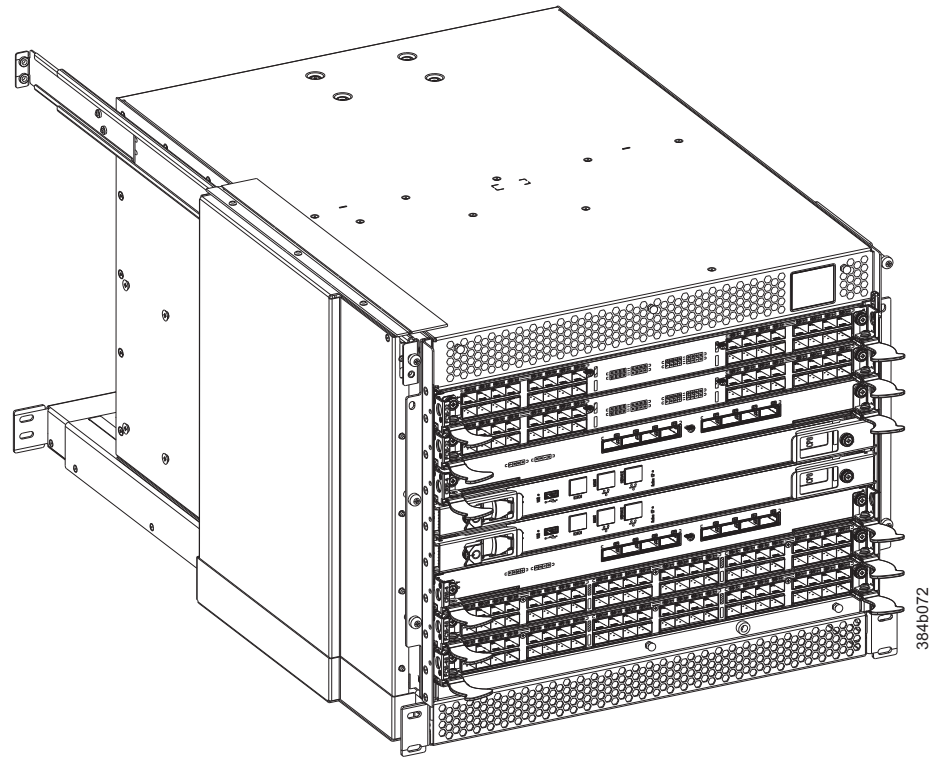

Figure 2. Port side of the SAN384B-2 with the exhaust kit installed (sample configuration)

Figure 3 on page 5 shows the non-port side of the SAN384B-2.

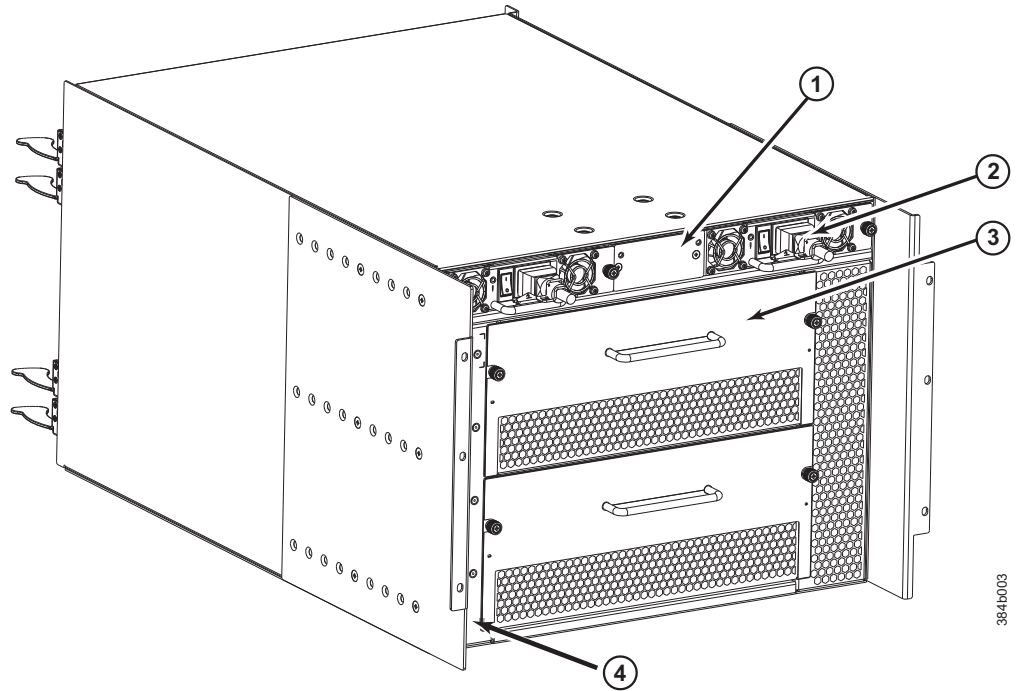

Figure 3. Blower (non-port) side of the SAN384B-2

- 1** WWN bezel

2 Power supply (2x)
- 3** Blower assembly (2x)

4 Label with serial number and WWN

SAN384B-2 blades

Table 2 summarizes the port, application, control processor, and core switch blades that are available for the SAN384B.

Table 2. Blades available for the SAN384B-2

Description	Feature Code	Name	Function
Control processor blade	N/A	CP8	The CP8 blade contains the control plane for the chassis. There are two CP8 blades for redundancy. This control processor blade is compatible with the SAN768B-2, SAN384B-2, SAN768B, and SAN384B.

Table 2. Blades available for the SAN384B-2 (continued)

Description	Feature Code	Name	Function
Core switch blade	N/A	CR16-4	The CR16-4 blade contains the ASICs for switching between port blades. There can be up to 192 16-Gbps (256 8 Gbps) total ports for port blades. Each core switch blade connects to 128 backplane ports. Core switch blades have additional front port connectivity to connect multiple chassis and backplane connections for the storage server blade. This core switch blade is compatible only with the SAN384B-2.
32-port 16-Gbps port blade	FC3632	FC16-32	A 32-port port blade supporting 2, 4, 8, 10, and 16 Gbps Fibre Channel port speeds. The blade also supports port-based in-flight encryption / decryption and compression / decompression. This port blade is compatible with the SAN384B-2 and SAN768B-2.
48-port 16-Gbps port blade	FC3648	FC16-48	A 48-port port blade supporting 2, 4, 8, 10, and 16 Gbps Fibre Channel port speeds. The blade also supports port-based in-flight encryption / decryption and compression / decompression. This port blade is compatible with the SAN384B-2 and SAN768B-2.
32-port 8-Gbps port blade	FC3633	FC8-32E	A 32-port port blade supporting 2, 4, and 8 Gbps Fibre Channel port speeds. This port blade is compatible with the SAN384B-2 and SAN768B-2. This blade requires Fabric OS v7.0.1 or later to run in this chassis.

Table 2. Blades available for the SAN384B-2 (continued)

Description	Feature Code	Name	Function
48-port 8-Gbps port blade	FC3649	FC8-48E	A 48-port port blade supporting 2, 4, and 8 Gbps Fibre Channel port speeds. This port blade is compatible with the SAN384B-2 and SAN768B-2. This blade requires Fabric OS v7.0.1 or later to run in this chassis.
64-port 8-Gbps port blade	FC3864	FC8-64	A 64-port port blade supporting 2, 4, and 8 Gbps port speeds with mSFPs. This port blade is compatible with the SAN768B-2, SAN384B-2, SAN768B, and SAN384B
FCIP extension blade	FC3890	8 Gbps Extension Blade (FX8-24)	The FX8-24 blade enables FCIP functionality over existing IP infrastructure. It has 12 FC ports, ten 1 GbE ports, and two 10 GbE ports available. This application blade is compatible with the SAN768B-2, SAN384B-2, SAN768B, and SAN384B
Encryption blade	FC3895	FS8-18	The FS8-18 blade enables data cryptographic (encryption/decryption) and data-compression capabilities for data-at-rest. It has 16 Fibre Channel 8 Gbps optical SFP ports. This application blade is compatible with the SAN768B-2, SAN384B-2, SAN768B, and SAN384B.

High availability

The following features contribute to the SAN384B-2 high-availability design:

- Redundant, hot-swappable FRUs, including blades, power supplies, fan assemblies, and WWN cards
- Enhanced data integrity on all data paths
- Fabric Shortest Path First (FSPF) rerouting around failed links
- Integration with Simple Network Management Protocol (SNMP) managers
- Automatic control processor failover
- Nondisruptive "hot" software code loads and activation
- Easy configuration, save, and restore
- Hot-swappable World Wide Name (WWN) cards

The high-availability software architecture of the SAN384B-2 provides a common framework for all applications that reside on the system, allowing global and local status to be maintained through any component failure. High-availability elements consist of the High Availability Manager, the heartbeat, the fault/health framework, the replicated database, initialization, and software upgrade.

The High Availability Manager controls access to the standby control processor, facilitates software upgrades, prevents extraneous CP failover activity, closes and flushes streams, provides flow control and message buffering, and supports a centralized active and standby state.

Reliability

The SAN384B-2 uses the following error detection and correction mechanisms to ensure reliability of data:

- Error Detection and Correction over main control processor memory.
- Error Detection and Correction mechanism, which checks for encoder errors and fault isolation (EDFI), such as cyclic redundancy checking (CRC), parity checking, checksum, and illegal address checking.
- Power-on self test (POST)
- Dual control processors that enable hot, nondisruptive fast firmware upgrades
- Each control processor contains one serial port and two Ethernet ports, for management and for service. The standby control processor monitors diagnostics to ensure the system is operational should a failover be necessary.
- Bus monitoring and control of blades and other field-replaceable units (FRUs).

Serviceability

The SAN384B-2 provides the following features to enhance and ensure serviceability:

- Modular design with hot-swappable components
- Flash memory that stores two firmware images per control processor
- USB port on control processor blades for most tasks that formerly required an FTP/SCP server, including software and firmware upgrades.
- Nonvolatile random-access memory (NVRAM), containing the OEM serial number, IBM serial number, revision information, and part number information
- Background health-check daemon
- Memory scrubber, self test, and bus ping to determine if a bus is not functioning
- RASlog messages
- SMI-S compliant
- Hardware and software watchdog timers
- Status LEDs
- Predictive diagnostics analysis through Fabric Watch
- SNMP (including version 3) integration with higher-layer managers
- Vertical cable management finger assemblies to accommodate the horizontal orientation of the blades

Software features

The Fabric OS allows any Fibre Channel-compliant device to attach to the switches as long as it conforms to the device login, name service, and related Fibre Channel standards. Each operating environment requires that a Fibre Channel host bus adapter (HBA) be available with a standards-compliant driver for correct interface to the fabric.

Fabric OS consists of a set of embedded applications running on top of an embedded Linux operating system kernel. These applications include:

- Name server
- Alias server
- Zone server
- Simple Network Management Protocol (SNMP) agent
- SMI-S compliant API
- Syslog auditing
- RCS (Reliable Commit Service)
- NTP
- Tasks to manage address assignment, routing, link initialization, fabric initialization, link shutdown, chassis shutdown, and the user interface.
- FICON[®] with CUP Activation (optional feature), providing in-band management of the supported SAN b-type switch and director products by system automation for z/OS from IBM System z10 EC, z10 BC, z9 EC, z9 BC, zSeries 990, 900, 890, and 880 servers.
- FICON Accelerator (optional feature), which is designed to support secure high-speed data movement between multiple locations

Security

The list below highlights some of the key security features available for the SAN384B-2 and for other enterprise-class products running Fabric OS 7.0.1 or later.

- DH-CHAP
- SSHv2 (using AES, 3DES, RSA)
- HTTPS (using AES)
- SNMPv3
- FC-SP
- Secure RPC
- Secure file copy (SCP)
- Telnet disable
- Telnet timeout
- IP filters (block listeners)
- Secure passwords (centralized control through RADIUS/CHAP)
- Multiple user accounts (MUAs). Up to 255.
- Role-based access controls (RBACs)
- Administrative domains/Virtual fabrics
- Boot PROM password reset
- Password hardening policies
- Upfront login in Web Tools
- Login banner

- Monitoring of attempted security breaches (through audit logging)
- Monitoring of attempted security breaches (through Fabric Watch Security Class)
- Fibre Channel security policies: DCC and SCC
- Trusted Switch (FCS) for central security management
- Management access controls (SNMPv3, Telnet, FTP, serial port, front panel)
- Hardware-enforced zoning by WWN, domain/port ID, or both
- Default zoning
- RSCN suppression and aggregation
- Configurable RSCN suppression by port
- NTPv3 (to synchronize timestamps)
- Event auditing
- Change tracking
- Firmware change alerts in Fabric Manager
- Persistent port disable
- Persistent domain ID
- E_Port disable

Installation of the optional Federal Information Processing Standards 140-2 (FIPS 140-2) security seals to the SAN384B-2 chassis, blades, and other components is available through Feature Code 7230. The *IBM System Storage FIPS 140-2 Security Seal Application Procedures* (GA32-2220-00) publication provides complete instructions for installing this feature on this and other models. The publication is available through the IBM Support Portal, www.ibm.com/supportportal or the IBM Publications Center www.ibm.com/shop/publications/order. Search by title or publication form number on either site.

Network Manageability

The SAN384B-2 has a single domain and is managed as a single element with the Network Advisor. The SAN384B-2 responds to its own IP address and appears as a separate entity to the Telnet protocol and SNMP.

All management interfaces, such as Telnet, Web Tools, standards compliant SMI-S, and Management Server, support a "port N within blade M" naming scheme.

The SAN384B-2 supports SNMPv1 and SNMPv3. When SNMP devices send SNMP messages to a management console running SAN management software, the information is stored in a management information base (MIB). Fabric OS 7.0 and later supports the latest Fibre Alliance Fibre Channel Management (FCMGMT) and Storage Management Initiative (SMI) MIBs, which allow common information necessary for management software to provide information to a SAN administrator. Refer to the *Fabric OS MIB Reference* for additional MIB information.

Chapter 2. Installing a SAN384B-2 in a cabinet

The SAN384B-2 is only available for installation in the IBM TotalStorage 2109 SAN Switch Cabinet C36. This product is to be installed and serviced only by qualified IBM service representatives. The SAN384B-2 can be ordered pre-installed in the cabinet, or it can be added to an existing C36 cabinet. The cabinet is designed to support a total of three SAN384B-2s. Each installation of the SAN384B-2 requires the port-side exhaust vent kit, which directs the exhaust to the service aisle and also serves as the rack installation kit. If three SAN384B-2 products are ordered, two will be pre-installed in the C36 cabinet, and the third will be installed in the cabinet at the customer site.

This chapter describes how to install a SAN384B-2 into a C36 cabinet, and how to remove the SAN384B-2 from the cabinet in the event you need to move or replace the system. If all SAN384B-2 units are already installed in the cabinet, continue on to Chapter 3, “Starting and configuring the SAN384B-2,” on page 33. The installation requires a minimum of two people for a safe installation.

Attention: Refer to “Safety notices” on page xv for general safety instructions “Safety notices and labels” on page xv, and “Rack safety” on page xxii before performing any installation or service procedures.



CAUTION:

The weight of this part or unit is more than 55 kg (121.2 lb). It takes specially trained persons with a lifting device to safely lift this part or unit. (C011)

CAUTION:

A fully populated SAN384B-2 weighs approximately 68 kg (150 lb). Before you install it, verify that the additional weight of the chassis does not exceed the cabinet's weight limit or unbalance the cabinet. When you calculate the additional weight, include the weights of all components that can potentially be added, to avoid overloading in the future.

CAUTION:

For CA residents only: IBM recommends installing this product in a room size of 62 cubic meters (2190 cubic feet) or larger at 0.4 ACH ventilation rate to reduce the concentrations of any chemicals emitted by the product.

Items included with the SAN384B-2

Each SAN384B-2 ships with the following :

- One SAN384B-2 chassis populated with:
 - Control processor blades (CP8)
 - Core switch blades (CR16-4)
 - Port blades and application blades specified on customer order
 - SFP+, mSFP, and QSFP optical transceivers as specified on the customer order
 - Blade slot filler panels (for slots not filled by blades)
 - Port side exhaust kit, which also functions as the rack mount kit

- WWN cards and WWN bezel
- Power supplies
- Blower assemblies
- Cable management finger assemblies
- Chassis door
- Accessory kit containing:
 - Documentation CD (contains documents related to the product and Fabric OS)
 - ESD grounding strap
 - USB device
 - RS-232 serial cable. The RS-232 cable has an adapter at one end that can be removed to provide an RJ-45-style connector.
 - Warranty
 - Safety notices

Ordering the lift tool

Important

The lift tool is required only when you install an additional SAN384B-2 or when you install or remove the SAN384B-2 from the cabinet. Ensure that the lift tool will be available on location at the time of the installation.

The ordering procedures for the lift tool vary depending on your location. You should direct questions about these procedures to your regional representative.

World trade locations

The following ordering procedures are for world trade locations:

- Order the lift tool by using the parts order system, like any other part.
- Use the following part numbers when you order:
 - Lift tool: PN 09P2481
 - The lift tool will include the required 24-inch load plate: PN 11P4369
- You do not record parts usage.
- Return the lift tool and the 24-inch load plate to the parts center after you complete the installation or removal of the SAN384B-2.

United States locations

In the United States, call UPS Logistics at 800-528-6070 to order the lift tool and the 24-inch load plate.

Note: For the SSR branch and territory, the United States cannot order the lift tool or 24-inch load plate through the parts order system. UPS Logistics are used to ship and return the lift tool and 24-inch load plate.

Use the following part number when you order:

- Lift tool: PN 09P2481 (order includes 24-inch load plate: PN 11P4369)

Attention: When you order the lift tool, you will receive an 18-inch load plate and a 24-inch load plate. Do *not* use the 18-inch load plate. You *must* use the 24-inch load plate when you install the SAN384B-2 to be able to safely install this product. The 24-inch load plate includes a platform with a middle section that can slide out to extend across the gap between the lift tool and the mounting position inside the C36 cabinet.

You must provide the following information when you order the lift tool. This information is necessary to ensure that the lift tool is delivered when you need it. Failure to provide this information might delay the completion of the order request and the shipping request. It might also result in a time and date to return the tool that is different from what you need.

- Phone number and customer contact
- Account code: 98577
- Time and date of delivery
- Accurate destination address with zip code
- Time and date of return pickup

You must return the lift tool at the time that was scheduled with UPS Logistics. If you need to change the scheduled return time or date, contact UPS Logistics.

You are responsible for ensuring that all of the paperwork and components are packed and restored in the arbocrate (shipping container) of the lift tool. Ensure that the lift tool is functioning properly before you release the tool to UPS Logistics for return. You are accountable for the lift tool until UPS Logistics picks up the lift tool for return delivery to their parts storage facility.

Contact your branch office tools coordinator or your region specialist if you have any questions or concerns.

Installation guidelines

Follow these general installation guidelines:

1. Provide a space that is 9 rack units (9U) high, 61.19 cm (24.09 in.) deep, and 43.74 cm (17.22 in.) wide. 1U is equal to 4.45 cm (1.75 in.).
2. Ensure that dedicated electrical branch circuits with the following requirements are met:

Note: See “Power specifications” on page 130 in the “Specifications” appendix for specific requirements depending on your chassis configuration.

- 200–240 VAC, 50–60 Hz (two branch circuits)
- Two cables for the 200–240 VAC service
- Protected by a circuit breaker in accordance with local electrical codes
- Supply circuit, line fusing, and wire size adequate to the electrical rating on the chassis nameplate
- Location close to the chassis and easily accessible
- Grounded outlets installed by a licensed electrician and compatible with the power cords

Attention: To maximize fault tolerance, connect each power cord to a separate power source.

3. To ensure adequate cooling, plan to install the chassis with the port side facing the aisle where exhaust air is released (usually called the service aisle). This prevents the fans from pulling in heated exhaust air.
4. Plan for managing the cables before you install the chassis. A fully populated SAN384B-2 will have a large number of cables that must be carefully routed to minimize problems with installation and replacement of components, and in order to maintain the minimum bend radius required for optical cables. Due to port density and the potentially large number of cables, if cables are not routed to the sides, then removal and replacement of blades and other components may be difficult to accomplish. Refer to “Managing cables” on page 44 for more specific information. You can manage the cables in a variety of ways, such as:
 - Routing the cables through the vertical cable management finger assemblies installed on either side of the chassis
 - Routing the cables out to either side of the chassis
 - Routing the cables through the cable channels on the sides of the cabinet
 - Using patch panels
5. Ensure that the following are available for configuration:
 - Workstation with an installed terminal emulator, such as HyperTerminal
 - Serial cable (provided)
 - Three Ethernet cables (including one spare)
 - Access to an FTP server for backing up the switch configuration or collecting supportsave output data (optional)
 - Brocade USB drive for collecting supportsave output data (optional)
 - SFPs and compatible cables
6. Ensure that the air intake vents have a minimum of 2 inches of airspace.
7. Ensure that the air temperature on the air intake side is less than 40°C (104°F) during operation.

Installing a SAN384B-2 in a 2109 C36 cabinet

This section describes how to install the SAN384B-2 in the Model C36 cabinet. These procedures use parts that are included in the hardware accessory kit and the port-side exhaust kit, which also functions as a lower supporting shelf. No rack-mount rail kit is required for this installation.

To safely complete the installation, a minimum of two people are required.

Time required

Allow approximately 3 hours to complete this entire procedure. This total includes unpacking, assembling, disassembling, and repacking the lift tool. The time estimate is for the physical installation of the SAN384B-2 only. It does not include installing Ethernet cables, transceivers, attaching and routing the fiber optic cables, or completing the initial configuration.

The SAN384B-2 and the lift tool should be delivered to a location near to the final installation, with clear aisles for maneuvering the lift tool loaded with the chassis. Since the lift tool can be used to move the chassis the short distance from the delivery location to the installation, it is recommended that you assemble the lift tool before starting the installation steps.

Attention: If optional feature FC 7230, FIPS 140-2 Level 2 Tamper Proof Seals is also ordered, be sure to sequence the installation steps to allow for application of the FIPS seals on the chassis and port side exhaust kit prior to installing the chassis in a rack. These locations may be difficult to access once the chassis is installed. Refer to the *IBM System Storage FIPS 140-2 Security Seal Application Procedures* (GA32-2220-00) publication for complete instructions.

Note: Brief assembly instructions for the lift tool are attached to the back of the lift tool. Additional instructions are included below in “Unpacking and assembling the lift tool” on page 16.

Table 3 provides a summary of time estimates for the different installation tasks and the tools required for each task.

Table 3. Installation tasks, time, and items required

Installation task	Time estimate	Items required
Unpacking and assembling the lift tool	15 minutes	No special tools required.
Site preparation and unpacking the SAN384B-2	30 minutes	#2 Phillips screwdriver (for cable management comb) Pallet jack (if the shipment has not been positioned near the installation site)
Installing the port-side exhaust kit	30 minutes	Torque wrench with #2 Phillips screwdriver tip Flathead screwdriver
Mounting and securing the SAN384B-2 in the rack	30 minutes	Torque wrench with #2 Phillips screwdriver tip Lift tool and load plate
Installing power cables and powering on the SAN384B-2	20 minutes	Power cables
Establishing serial connection, logging on to the SAN384B-2, and configuring IP addresses.	20 minutes	Serial cable (provided in the accessory kit). Workstation computer with a serial port or terminal server port and a terminal emulator application (such as HyperTerminal). Ethernet IP addresses for the chassis and for both control processor blades (total of 3 IP addresses).
Installing an Ethernet cable, opening a Telnet session, and configuring the SAN384B-2 domain ID, date and time, and additional system parameters. Verifying and backing up the configuration.	20 minutes	Ethernet cable for Telnet access. Refer to the <i>Fabric OS Administrator's Guide</i> .
Installing transceivers as needed	20 minutes (longer if using high density port blades)	SFP+, mSFP, and QSFP optical transceivers as needed.
Attaching fiber optic cables, cable wraps, and cable guides	2-3 hours	Fiber optic cables and cable wraps.

Table 3. Installation tasks, time, and items required (continued)

Installation task	Time estimate	Items required
Disassembling and packing the lift tool	20 minutes	No special tools required.

Unpacking and assembling the lift tool

Assembling the lift tool before starting the installation will simplify the installation.

The lift tool consists of several parts, including:

- The fully assembled main vertical section of the lift tool with wheels, wheel lock, cables and winch attached
- Attachable lift forks, which slide onto the front of the lift tool and are secured in place by spring-loaded pins and ring pins
- 24-inch load plate with sliding middle section (do *not* use the 18-inch solid single-piece load plate)
- Anti-tip bars
- Retention straps
- Wheel chocks

Assembly instructions are attached to the back of the main vertical section of the lift tool. The following supplemental information may help with the assembly.

1. With one person at either end, lift the main section of the lift tool out of the shipping crate.
2. Review the assembly instructions attached to the back of the lift tool, if necessary.
3. With the lift tool still horizontal, insert the two legs with caster wheels into the holes in the front of the lift tool.
4. Pull up on the spring-loaded leg lock pins, sliding the legs in until the pins snap into place through the holes in the legs, securing them in place.
5. Tilt the lift tool upright, resting on all four wheels. Set the wheel brake, if desired, by stepping down on the brake pedal. (Note the brake release on the left side of the brake pedal.)
6. Attach the two forks to the lift tool, sliding the two holes in each over the ends of the two bars. If the winch is in the lowest position, you may need to raise it to provide enough clearance to slide the forks into position. Secure each lifting fork in place with two ring-pins.
7. Attach the 24-inch load plate, by slipping the top curved portion under the horizontal bar, and resting the load plate on the forks.
8. Attach the anti-tip bars (recommended to provide additional stability when the loaded lift tool is raised more than 45 cm (18 in) high). Install these from the rear of the lift tool, by sliding them inside the horizontal legs, pulling up on the leg lock pins to allow the pins to engage the holes in the legs and the anti-tip bars.
9. Secure the anti-tip brackets to the lift tool with the supplied brackets and bolts.
10. The lift plate has a middle section that can be extended to the right (when viewed from the back of the lift tool). This middle section is secured in place by two spring-loaded pins. Familiarize yourself with releasing the pins and sliding this section. There are two stops: half-way extended and fully

extended. This middle section will need to be fully extended during the installation to safely span the gap between the lift tool and the cabinet mounting position.

11. Move the assembled lift tool and retention straps near the equipment to be installed. Figure 4 shows the assembled lift tool with the 24-inch load plate installed.



Figure 4. Assembled lift tool with 24-inch load plate

Unpacking the SAN384B-2



CAUTION:

The weight of this part or unit is more than 55 kg (121.2 lb). It takes specially trained persons with a lifting device to safely lift this part or unit. (C011)

To unpack the SAN384B-2, follow these steps:

1. If the product needs to be transported a long distance, or if there are uneven floors to cross, keep the product in its original packaging, and relocate the entire shipment close to the installation location, using a pallet jack to lift and move it.

Note: The standard packaging does not incorporate a wood pallet and pallet brackets. The chassis sits on top of a plastic shipping tray.

2. Once the shipment is in a location close to the installation, cut the bands that encircle the packaging.
3. Lift the cardboard box off the chassis. Installation kits are packed within this outer carton, so you may need to open the top of the box to remove the kits or to press down on them as you lift the outer carton. Save the packing materials if you are returning an old chassis.

4. Remove the port side exhaust kit, hardware accessory kit, chassis door, cable management finger assemblies, and foam from the top of the chassis. Remove the loose foam blocks from the corners of the chassis. Remove the anti-static plastic from the chassis.
5. Place the kits and other installation pieces near the installation.
6. Move the lift tool next to the plastic shipping tray at the blower and power supply end of the chassis. Position the lift tool with its left side next to the shipping tray (see Figure 5).

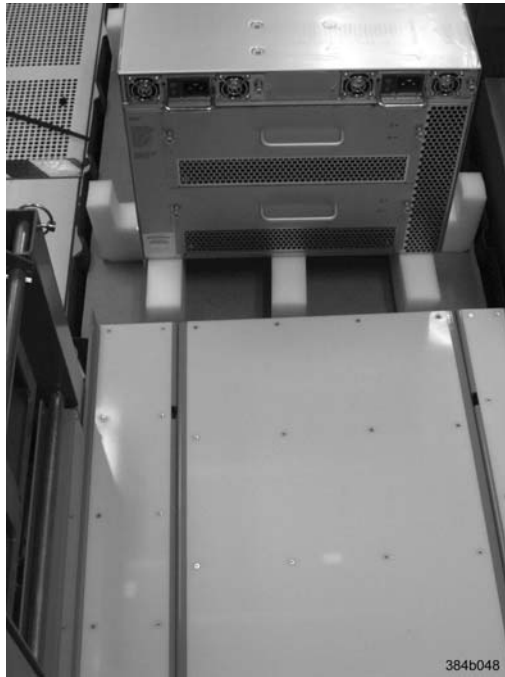

Figure 5. Lift tool positioned next to the chassis on the shipping tray

7. Using the lift tool winch mechanism, adjust the height of top of the load plate to slightly below the bottom surface of the chassis.
8. Set the lift tool brake.
9. Carefully slide the chassis across the foam blocking in the shipping tray and onto the center of the load plate. Do not use any of the handles on the blowers or power supplies to move the chassis.
10. Attach the lift tool retention straps to secure the chassis to the load plate. This is particularly important if you will be moving the chassis across any uneven floor, or will be raising the chassis more than 45 cm (18 inches).
11. For safety considerations during moving, lower the load platform to its lowest position.
12. Release the lift tool brake, and carefully move the chassis near the cabinet for installation.

Installing the port-side exhaust kit

Complete the following instructions to install the port-side exhaust kit in a 2109-C36 cabinet before installing the SAN384B-2 chassis.

Exhaust kit parts list

Table 4 lists items illustrated in Figure 6 on page 20.

Table 4. Parts list for port-side exhaust kit for C36 cabinets

Item	Description	Quantity
A	Top rail	1
B	Duct	1
C	Shelf	1
D	10-32 x .5 in. (1.27 cm) Phillips screw (blue Loctite on threads)	12
E	10-32 x .63 in.(1.60 cm) Phillips screw with square cone washer	12
F	10-32 clip nut for cabinets that have rails with round holes	8
G	10-32 retainer nut for cabinets that have rails with square holes	8
H	Alignment washer for cabinets that have rails with square holes	12
I	6-32 x .25 in. (.635 cm) Phillips screw	2

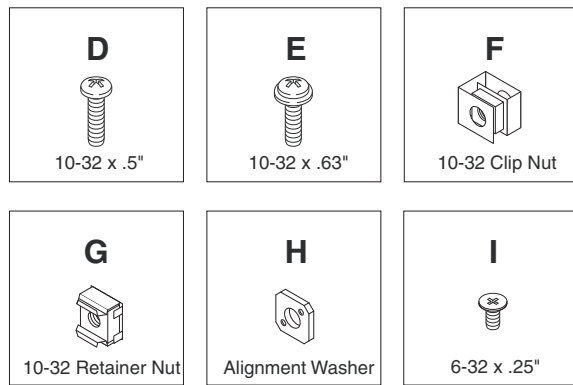
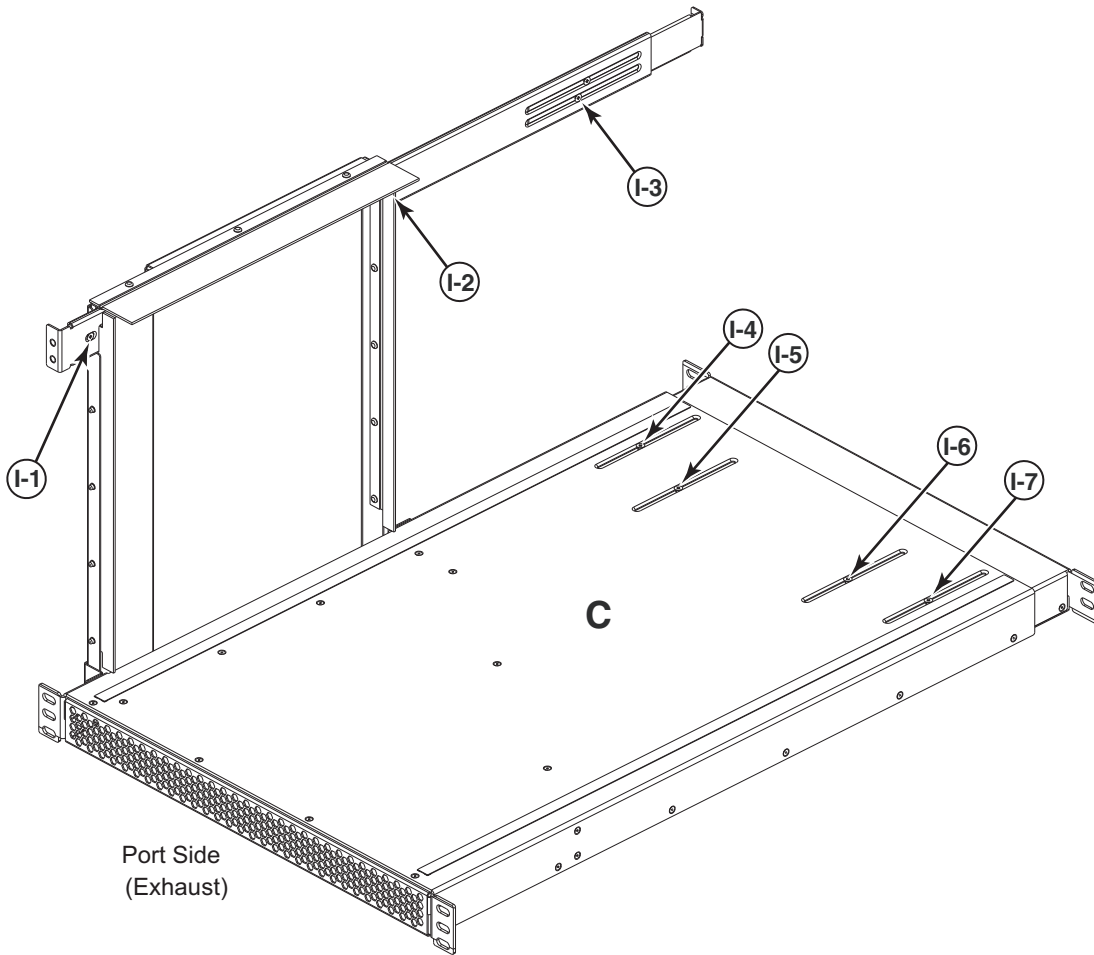

384b032

Figure 6. Port-side exhaust kit assembly for 27 to 31 in. (68.58 to 78.74 cm) cabinets

Torque requirements

Use the following torque settings when tightening screws that secure the port-side exhaust kit and SAN384B-2 to the equipment cabinet.

Table 5. Torque requirements for mounting screws

Screw size	Torque
6-32 x .25 in. (.635 cm) Phillips screw	8.75 in.-lbs (10 cm-kg)
10-32 x .63 in.(1.60 cm) Phillips screw	32 in.-lbs (36.86 cm-kg)

Installing the exhaust kit hardware

1. Remove the rear door (exhaust side) from the C36 cabinet. Set the door aside, away from the installation.
2. The exhaust side of the port side exhaust kit will be installed facing the rear of the C36 cabinet, and the port side of the SAN384B-2 chassis will also face this direction.
3. Install 10 clip nuts (F in Figure 6 on page 20) or retainer nuts (G) in the rear vertical cabinet rail locations shown in Figure 7 on page 22, and 4 clip nuts or retainer nuts in the front vertical cabinet rails. Eight clip nuts and retainer nuts are provided with the exhaust kit, and six are provided with the hardware accessory kit. Install the lower two nuts at the same relative locations on all four cabinet vertical rails, to provide a level mounting of the shelf. The fourteen nuts will secure the eight 10-32 screws that mount the port side exhaust kit shelf (position 23 in Figure 7 on page 22) and the six that are used to attach the SAN384B-2 chassis to the cabinet (positions 25, 28, and 30 in Figure 7 on page 22).

Note: For rails with round holes, use clip nuts. For rails with square holes, use retainer nuts. Figure 7 on page 22 is only an example showing relative positions for these nuts in the cabinet rails to mount the shelf and chassis. You can mount the shelf and chassis in 9 U of cabinet space higher or lower in the cabinet than shown.

Note: Screws, clip nuts, and retainer nuts for attaching the SAN384B-2 to the cabinet are provided in the SAN384B-2 hardware accessory kit.

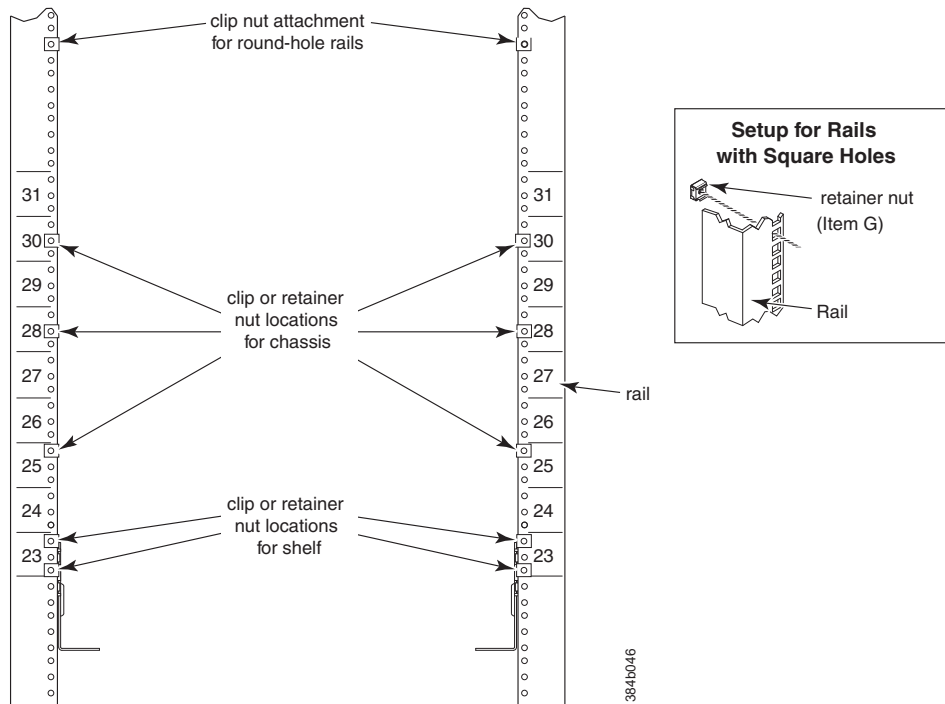

Figure 7. Clip and retainer nut locations on exhaust side cabinet rails (example showing relative positions)

4. Install the shelf (C in Figure 6 on page 20), using these steps:

- a. The shelf can be adjusted to a length of between 27 and 31 inches (68.58 and 78.74 cm) to match the cabinet size. To lengthen or shorten the shelf, loosen by approximately 1/2 turn the four 6-32 screws in the four slots on the shelf (I-4 through I-7 Figure 6 on page 20) and adjust the shelf to the desired length.

Note: We recommend two people for the installation of the shelf, one at either end of the cabinet to support and align it correctly while attaching it to the cabinet.

- b. Tilt the shelf at an angle to fit it between the rails, and then position it horizontally and level with the shelf mounting tabs on the outside of the cabinet vertical rails, and aligned with the clip nuts you installed earlier.
- c. Secure the shelf to the cabinet with eight 10-32 screws with washers (E in Figure 6 on page 20), two screws in each corner of the shelf (see Figure 8 on page 23). Tighten screws according to specifications under “Torque requirements” on page 21.

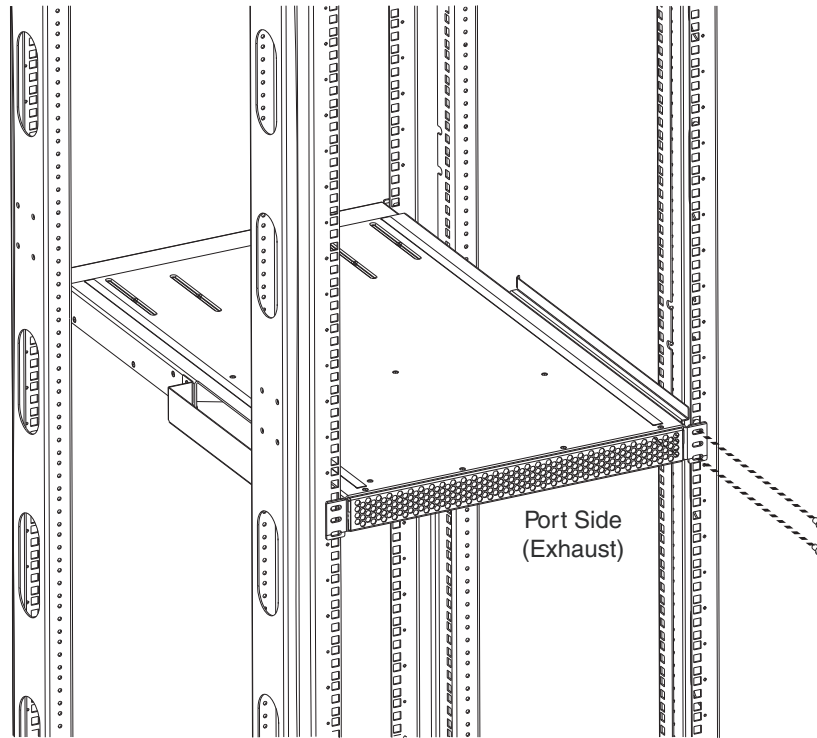

384b034

Figure 8. Shelf installed in cabinet

- d. Tighten the four 6-32 screws on the top of the shelf, which were loosened to adjust the shelf length.
5. Install the air-duct assembly (B in Figure 6 on page 20) by inserting it down into the side slot on left side of the shelf (see Figure 9). Ensure that the tabs of the duct align and engage with the slots in the shelf, with the open side of the duct facing towards the center of the cabinet.

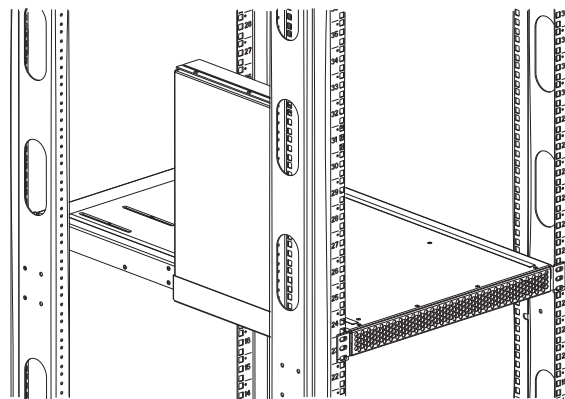

384b036

Figure 9. Air duct installed into side slot in shelf

6. Attach the top-rail assembly (A in Figure 6 on page 20) to the air-duct assembly.
 - a. The top-rail assembly can be adjusted to a length of between 27 and 31 inches (68.58 to 78.74 cm) to fit on the *inside* of the cabinet rails. To lengthen or shorten the top-rail assembly, loosen, by approximately 1/2 turn, the two

- 6-32 screws (I-3 in Figure 6 on page 20) and adjust the top-rail assembly to the desired length. The length will be approximately the length of the adjustable shelf.
- b. Insert the top-rail assembly down into the air-duct assembly and then secure the top-rail assembly to the air-duct assembly with two 6-32 screws, one screw on each side of the air-duct assembly (I-1 and I-2 in Figure 6 on page 20). Tighten screws according to specifications under “Torque requirements” on page 21.
7. Secure the top-rail assembly to the cabinet with four 10-32 screws, two screws on each end of the top-rail assembly (see Figure 10).

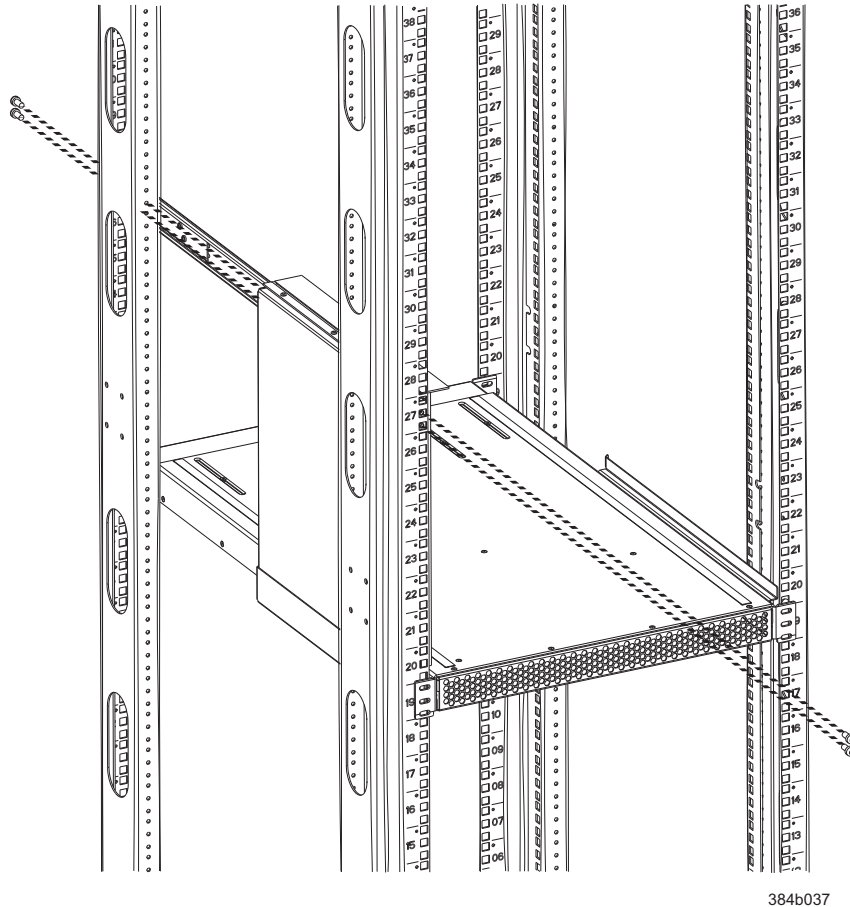

384b037

Figure 10. Installing the top rail assembly to the duct assembly and cabinet rails

- a. For rails with round holes:
Use two 10-32 screws with washers (E in Figure 6 on page 20) on each end of the top rail assembly. Tighten screws according to specifications under “Torque requirements” on page 21.
 - b. For rails with square holes:
Use the two standard 10-32 screws (D in Figure 6 on page 20) with blue Loctite on the threads and alignment washers (H in Figure 6 on page 20) on each end of the top rail assembly. Tighten screws according to specifications under “Torque requirements” on page 21.
8. Tighten the two 6-32 screws (I-3 in Figure 6 on page 20) that were loosened in step 6a to adjust the top rail length.

Installing the SAN384B-2 into the cabinet

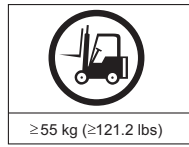

CAUTION:

A fully populated SAN384B-2 weighs approximately 68 kg (150 lb) and requires a minimum of two people and a lift tool to install it. (C011)

Now that the port-side exhaust kit is securely installed, the SAN384B-2 chassis can be safely installed into the C36 cabinet. Perform the following steps to install the chassis.

Note: The cabinet should already be fully installed, with leveling legs lowered to prevent it from moving during the chassis installation.

1. Move the lift tool to a position as close as possible to the rear of the cabinet. Position the lift tool so that the blower assemblies are facing towards the inside of the cabinet and the port side of the chassis facing away from the cabinet (see Figure 11).



Figure 11. Lift tool and chassis positioned at rear of cabinet

2. Set the wheel brake by pressing down on the wheel brake pedal.
3. Remove the lift tool retention straps from the chassis and the lift tool.
4. Carefully center the chassis over the middle section of the lift tool load plate.
5. Turn the lift tool winch handle clockwise to raise the load plate and chassis to approximately 2 cm (3/4 in.) above the height of the port side exhaust kit shelf.
6. Rotate the winch handle 1/4 turn counter clockwise to lock the winch.

7. Release the two spring-loaded pins on the under side of the load plate and slide the middle section as far as possible into the cabinet until it stops. The chassis should not move with the middle section.

Note: If the chassis is not carefully centered over the middle section, the weight of the chassis may prevent the middle section from sliding. Adjust the alignment if needed.

8. Release the spring-loaded pin closest to the cabinet one more time, and slide the middle section to its full extension. Make sure the spring-loaded pin snaps back into place. The gap between the end of the load plate middle section and the port side exhaust kit shelf should be no more than 2.5 cm (1 in.). If the gap is larger than this, either the lift tool is not positioned close enough to the cabinet, or the load plate middle section is not fully extended. Adjust as needed. Figure 12 shows a view from inside the cabinet, with the middle section of the lift tool load plate extended, and the chassis centered on the load plate.



Figure 12. Load plate extended inside the cabinet to the exhaust kit shelf

9. Carefully slide the chassis into the cabinet between the shelf and the upper edge of the exhaust kit duct assembly until the chassis rests securely on the shelf. Figure 13 on page 27 shows a view from outside the cabinet with the middle of the load plate fully extended and the chassis pushed approximately half way into the cabinet. Reposition the nut clips installed earlier if necessary. Push the chassis all the way into the cabinet until the flanges on the port side of the chassis are firmly against the cabinet vertical rails.

Note: If necessary, adjust the height of the load plate to allow a smooth transfer of the chassis from the extended load plate to the top of the shelf.



Figure 13. Chassis half way into cabinet on load plate

Note: For rails with round holes, use the clip nuts (F in Figure 6 on page 20) on the rails for securing the 10-32 screws. For rails with square holes, use the retainer nuts (G Figure 6 on page 20). Also refer to Figure 7 on page 22.

10. Release the spring-loaded pins under the load plate, and slide the middle section of the load plate back into load plate.
11. Lower the lift plate to its lowest position, release the wheel brake on the lift tool, and move the lift tool away from the cabinet.
12. If necessary, adjust the rubber strips on the exhaust kit duct to ensure a good seal against the chassis.
13. The chassis will be secured to the cabinet with six 10-32 screws with washers (see Figure 14 on page 28). Four of these screws will also be used to attach the cable management finger assemblies. Do not install the screws until you determine the position of the cable management fingers.

Note: Screws, clip nuts, and retainer nuts to secure the chassis to the cabinet are provided in the SAN384B-2 hardware accessory kit.

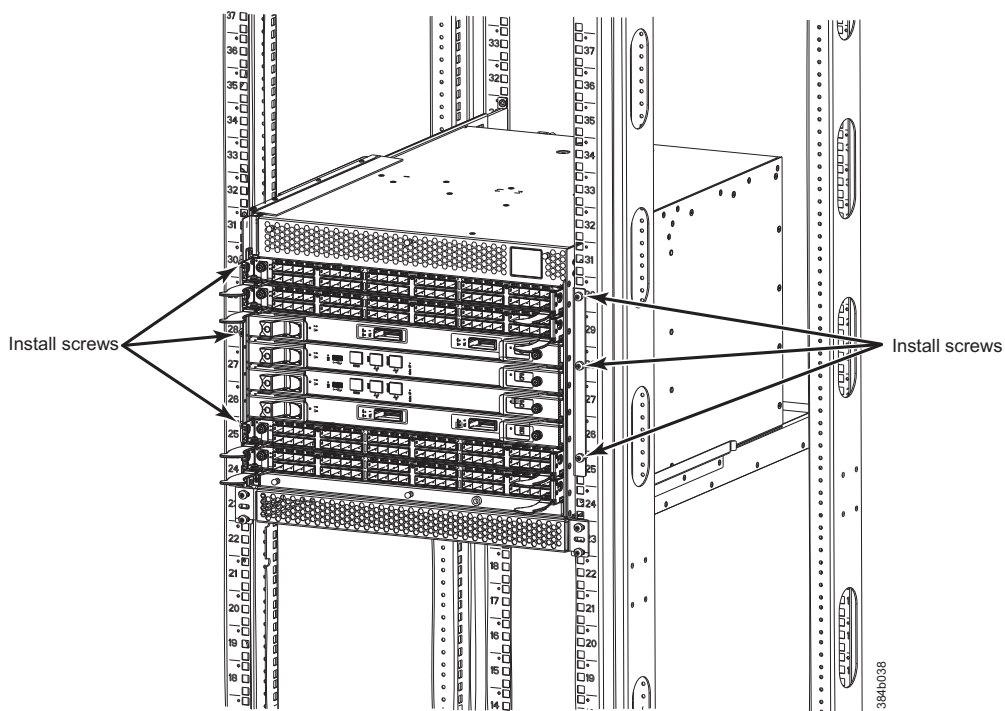

Figure 14. Location of screws to attach the chassis to the cabinet rails

14. Attach the two cable management finger assemblies to the cabinet vertical rails, using two screws each. The two assemblies are identical and can be installed on either side. The screws will extend through the chassis flange used to attach the chassis to the cabinet rails, and into the clip nuts you have installed. Select the holes on the cable management assemblies that match two of the holes on the chassis flange. You will be able to position the cable management finger assemblies either towards the top of the chassis or towards the bottom of the chassis, depending on your requirements for routing cables. The third screw for each side is used to secure the chassis to the rails, directly through the chassis flange into the clip nuts. These screws do not attach the cable management assemblies to the chassis or rack. Figure 15 on page 29 shows the cable management fingers positioned towards the top of the chassis.

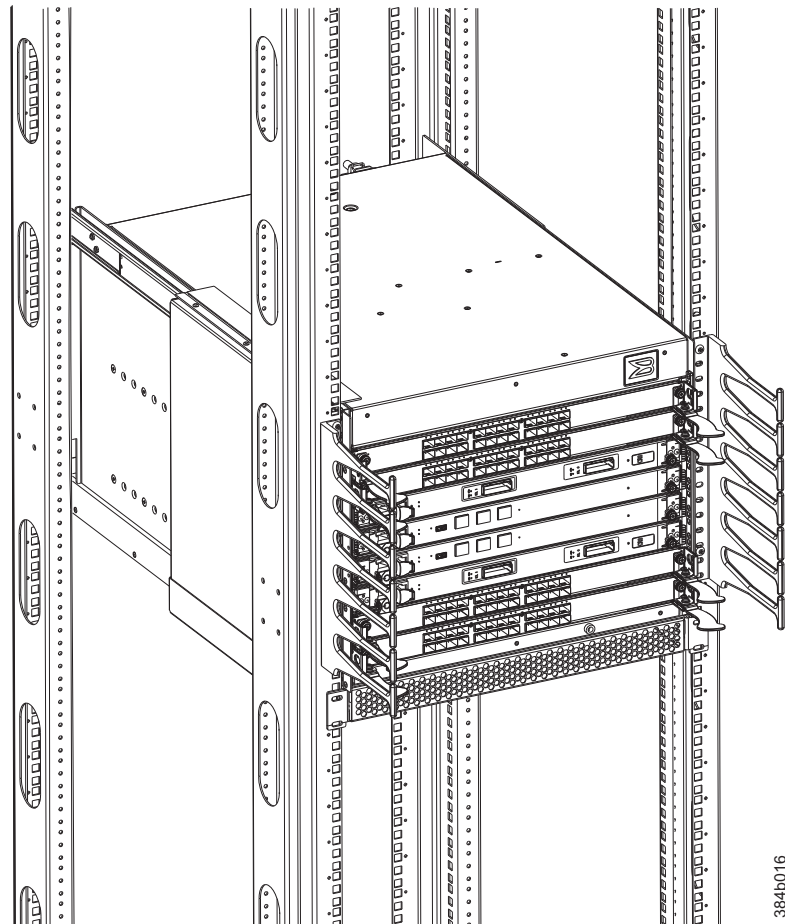

Figure 15. Attaching the vertical cable management finger assemblies to the cabinet rails

15. Disassemble and pack the lift tool into the shipping crate. Follow the return instructions provided.

Note: For turning on the power and for the configuration instructions, see Chapter 3, “Starting and configuring the SAN384B-2,” on page 33.

Attention: Do not connect the SAN384B-2 to the network until the IP addresses are correctly set.

Port numbering

Table 6 provides a list of available port and application blades for the SAN384B-2.

Table 6. Port and application blades available on the SAN384B-2

Blade label	IBM blade name	Feature code
FC16-32	32 port 16Gbps Switch Blade	3632
FC8-32E	32 port 8Gbps Enhanced Port Blade	3633
FC16-48	48 port 16Gbps Switch Blade	3648
FC8-48E	48 port 8Gbps Enhanced Port Blade	3649
FC8-64	64 port 8Gbps Switch Blade	3864
FX8-24	FCIP 8 Gbps extension blade	3890

Table 6. Port and application blades available on the SAN384B-2 (continued)

Blade label	IBM blade name	Feature code
FS8-18	16 port 8 Gbps encryption blade	3895

The SAN384B-2 uses the following port numbering for each of the blades that can be installed in the chassis. See illustrations of the different blades in Appendix D, "Port numbering," on page 141. Refer to *Implementing an IBM/Brocade SAN with 8 Gbps Directors and Switches*, (an IBM Redbook), SG24-6116 for more details on port numbering and other technical information.

Note: This publication was written for earlier products, but many of the practices still apply.

Note: Blades are installed in a horizontal orientation in the SAN384B-2 chassis, so the normal top of the blade is oriented to the left, and the normal bottom of the blade is oriented to the right when the blades are installed in the chassis.

- CR16-8 core blade - Inter-chassis link connectors are numbered from 0 through 7 from bottom to top on the left set of ports and 8 through 15 from bottom to top on the right set of ports. Each connector is actually a group of four 16 Gbps ports.
- FC16-32 port blade - Ports are numbered from 0 through 15 from right to left on the lower row of ports and 16 through 31 from right to left on the upper row of ports.
- FC8-32E port blade - Ports are numbered from 0 through 15 from right to left on the lower row of ports and 16 through 31 from right to left on the upper row of ports.
- FC16-48 port blade - Ports are numbered from 0 through 23 from right to left on the lower row of ports and 24 through 47 from right to left on the upper row of ports.
- FC8-48E port blade - Ports are numbered from 0 through 23 from right to left on the lower row of ports and 24 through 47 from right to left on the upper row of ports.
- FC8-64 port blade - Ports are numbered from 0 through 31 from right to left on the lower row of ports and 32 through 63 from right to left on the upper row of ports. See Figure 57 on page 143 for an illustration of the blade. Trunking groups are permitted with up to eight ports per group. Trunking groups are as follows: 0-7, 8-15, 16-23, 24-31, 32-39, 40-47, 48-55, and 56-63.
- FX8-24 FCIP extension blade - The port numbering scheme is fairly complex for this blade, but is displayed for reference on the blade itself in a diagram towards the right end of the blade (see Figure 59 on page 143). There are twenty-four physical ports. Twelve FC ports are located towards the right end of the blade, with ports 0 through 5 in the lower row, and ports 6 through 11 in the upper row. Two 10 Gigabit Ethernet (10GbE or XGE) ports are located in the lower row of ports and are numbered 0 and 1, from right to left. Ten GbE ports are located towards the left end of the blade, with eight clustered to the far left, and the remaining two located above the two 10GbE ports. The GbE ports 0 through 3, numbered from right to left are located in the lower row to the far left side of the blade. Ports 4 and 5 are located above the two 10GbE ports, and ports 6 through 9 (numbered right to left) are in the top row above ports 0 through 3. Up to three FC trunking groups. The three groups are defined as:
 - Trunk group 0: FC ports 0, 1
 - Trunk group 1: FC ports 6, 7

- Trunk group 2: FC ports 2, 3, 4, 5, 8, 9, 10, 11
- FS8-18 blade - The 16 physical Fibre Channel ports on this blade are numbered 0 through 15 from right to left. The two 10/100/1000 BaseT ports are numbered GE0 and GE1 from right to left.

Chassis slots

Slots are numbered 1 through 8, from bottom to top of the chassis when facing the port side of the SAN384B-2. Control processor blades (CP8) can be installed only in slots 4 and 5. Core switch blades (CR16-4) can be installed only in slots 3 and 6. Port, application, or encryption blades can be installed only in slots 1, 2, 7, and 8. Unused slots must be filled with blade filler panels to maintain adequate cooling.

See Appendix D, “Port numbering,” on page 141 for different SAN384B-2 port blades. Also refer to the IBM Redbook, *Implementing an IBM/Brocade SAN with 8 Gbps Directors and Switches*, SG24-6116, for more comprehensive information on port numbering and area port numbering, and other technical information. This publication is available through www.redbooks.ibm.com/. Search by title or publication number.

Note: This publication was written for earlier products, but many of the practices apply to this product.

Cable organization

Two vertical cable management finger assemblies (shown in Figure 32 on page 69) are attached to the rack vertical rails. They are not attached directly to the SAN384B-2 chassis. This pair of cable management finger assemblies can be used to keep the cables from hanging down in front of other blades, and to route them away from the exhaust vent of the port-side exhaust kit, which is located below the SAN384B-2 chassis.

Use these guidelines in planning for cable management:

- Plan for rack space required for cable management before installing the chassis
- Leave at least 1 m (3.28 ft) of slack for each port cable. This provides room to remove and replace the switch, allows for inadvertent movement of the rack, and helps prevent the cables from being bent to less than the minimum bend radius.
- If you are using ISL Trunking, consider grouping cables by trunking groups. The cables used in trunking groups must meet specific requirements, as described in the *Fabric OS Administrator's Guide*.
- For easier maintenance, label the fiber optic cables and record the devices to which they are connected.
- Keep LEDs visible by routing port cables and other cables away from the LEDs.
- Use hook and loop type straps to secure and organize fiber optic cables.

Attention: The minimum radius to which a cable can be bent under full tensile load is 5.1 cm (2 in). For a cable under no tensile load, that minimum is 3 cm (1.2 in).

Attention: Do not route the cables in front of the air exhaust vents, located at the top and bottom of the port side of the chassis.

The FC8-64 high density port blade cannot use the standard LC cables because the pitch between optics in the new mSFP transceiver is smaller than in standard SFPs. Patch cables and panels can be used to attach standard size cabling to the blade if necessary. Figure 16 illustrates the mSFP to SFP patch cable. The mSFP transceivers are used only with the FC8-64 port blade. Narrower OM-3 LC cables are used to connect the FC8-64. These cables are offered by several major manufacturers. Contact your IBM representative for options regarding different cable and patch panel configurations to simplify cable management with higher density FC8-64 port blades.

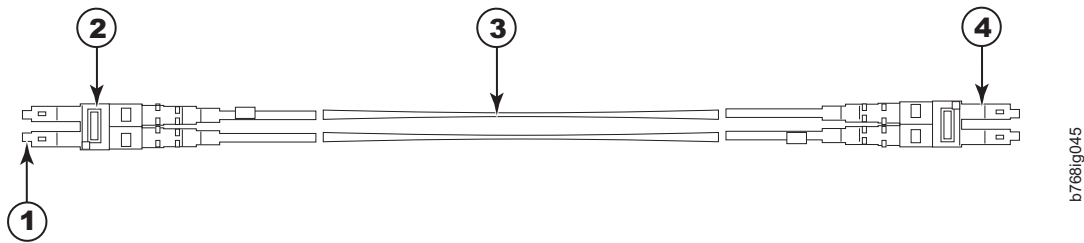

Figure 16. Cable design for the mSFP patch cables for the FC8-64 high density port blade

- | | | | |
|----------|---------------------|----------|---------------|
| 1 | mini-SFP connector | 3 | 1.6 mm cable |
| 2 | Duplex clip (black) | 4 | SFP connector |

Note that the duplex clip on the mSFP end of the cable is black for easier recognition.

If ISL Trunking is in use, group the cables by trunking group. The ports are color-coded to indicate which ports can be used in the same ISL Trunking group: eight ports marked with solid black ovals alternate with eight ports marked with oval outlines. See Table 25 on page 132 for a listing of supported cable speeds and distances.

Optional inter-chassis link cables (ICL) can also be installed between SAN384B-2 chassis. See “Removing and replacing inter-chassis link (QSFP) cables” on page 93 for instructions on installing these cables.

Chapter 3. Starting and configuring the SAN384B-2

Attention: Refer to the latest Fabric OS Release Notes or Interoperability Matrix for information regarding Fabric OS compatibility. This is particularly important for fabrics with 1-Gbps switches using earlier Fabric OS versions. To access the appropriate matrix:

- Go to the IBM SAN web page www.ibm.com/systems/storage/san
- Select the **IBM System Storage SAN768B-2 and SAN384B-2** product link
- On the displayed product page, click the **Interoperability Matrix** link in the **Learn more** section.

The SAN384B-2 must be configured before it is connected to the fabric, and all of the configuration commands must be entered through the active CP blade. The SAN384B-2 configuration includes the following parameters:

- IP address and subnet mask for the SAN384B-2
- IP addresses, host names, subnet masks, and gateway addresses for both CP blades
- Switch name
- Domain ID (optional)
- WWN for the chassis

Note: The SAN384B-2 WWN is initially set by the factory to match the license ID (which is based on the chassis serial number). The WWN can be changed, but the license ID cannot be modified.

The configuration information is mirrored to the standby CP blade, which allows the most current configuration to remain available even if the active CP blade fails. The configuration information for the SAN384B-2 is stored in the WWN cards and the flash memory of the CP blades. The configuration can be backed up to a workstation (uploaded) and then downloaded to the active CP blade if necessary.

Note: If the FS8-18 encryption blade is installed, refer to the *Fabric OS Encryption Administrator's Guide Supporting Tivoli® Key Lifecycle Manager (TKLM) Environments* for the procedures to configure the encryption functions.

Figure 17 on page 34 provides an overview of the sequence of tasks to configure the SAN384B-2.

Configuration Tasks

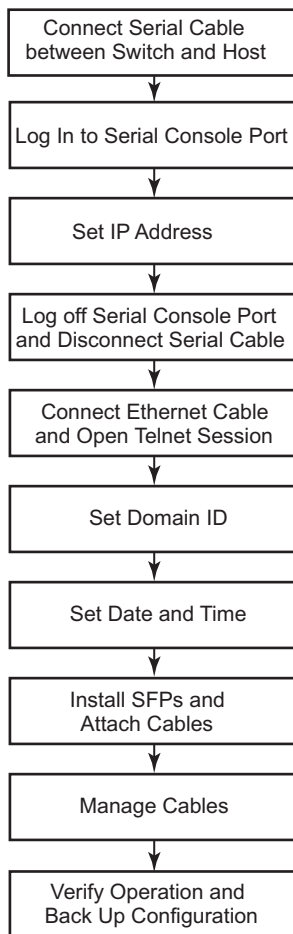

384b004

Figure 17. Flow of configuration tasks for the SAN384B-2

The initial physical hardware installation continues with the following steps:

- “Providing power to the SAN384B-2” on page 35
- “Connecting the SAN384B-2 and host with a serial cable” on page 35
- “Logging in to the serial console port” on page 36
- “Configuring the IP addresses” on page 36
- Installing optical transceivers and cables (see “Removing and installing transceivers” on page 89 and “Managing cables” on page 44)

The following additional steps are customer responsibilities required for the initial configuration:

1. Establish an Ethernet connection. See “Establishing an Ethernet connection” on page 38.
2. Specify a switch name. See “Customizing the switch name” on page 38.
3. Specify a domain ID for the SAN384B-2. See “Setting the Domain ID” on page 39.
4. Set the date and time. See “Setting the date and time” on page 39.
5. Connect to the fabric. See “Verifying the persistent PID feature” on page 41

6. Enable software licenses. See “Determining installed software licenses” on page 41.
7. Configure the optional FS8-18 encryption blade. See “Configuring for encryption (optional)” on page 46.
8. Back up the configuration. See “Verifying correct operation and backing up the configuration” on page 47.

Providing power to the SAN384B-2

DANGER

An electrical outlet that is not correctly wired could place hazardous voltage on the metal parts of the system or the devices that attach to the system. It is the responsibility of the customer to ensure that the outlet is correctly wired and grounded to prevent an electrical shock. (D004)

Attention: Use only the supplied power cords.

To provide power to the SAN384B-2:

1. Connect the two AC power cords to each of the two power supplies.
2. Connect the power cords to a power source with a voltage of 200 to 240 VAC, 47 to 63 Hz..
3. Turn the AC power switches on the power supplies to ON (I). The AC power switches light green when switched on and power is supplied.
4. The SAN384B-2 performs a power-on self-test (POST) each time it is powered on. POST takes approximately 10 minutes and is complete when indicator light activity displays the operational state. For information about LED patterns, see Chapter 4, “Monitoring system components,” on page 51.

You can bypass POST by using the **fastBoot** command. You can also disable POST for successive reboots on the SAN384B-2 using the **diagDisablePost** command.

Attention: To prevent a potential IP address conflict, do not connect the SAN384B-2 to the network until the IP addresses are configured.

Note: To power off the SAN384B-2, see “Powering off the SAN384B-2” on page 49.

Connecting the SAN384B-2 and host with a serial cable

To establish a serial connection to the console port on the CP blade, complete the following steps.

1. Verify that the SAN384B-2 is powered on and that POST is complete by confirming that all power LED indicators on the port, control processor, and core switch blades display a steady green light.
2. Remove the shipping cap from the CONSOLE port on the active CP blade. Use the serial cable provided with the product to connect the CONSOLE port on the active CP blade to a computer workstation. The active CP blade is indicated by an illuminated blue LED.

Attention: The CONSOLE port is intended primarily for the initial setting of the IP address and for service purposes.

3. Access the SAN384B-2 using a terminal emulator application (such as HyperTerminal in a Windows environment or TIP in a UNIX environment).

4. Disable any serial communication programs running on the workstation (such as synchronization programs).
5. Open the terminal emulator application and configure as follows:
 - In a Windows environment:

Table 7. Configuration parameters

Parameter	Value
Bits per second	9600
Data bits	8
Parity	None
Stop bits	1
Flow control	None

- In a UNIX environment, enter the string at the prompt:
`term /dev/ttyb -9600`
 If ttyb is already in use, use ttya instead and enter the following string at the prompt:
`term /dev/ttya -9600`

When the terminal emulator application stops reporting information, press **Enter**. You will receive the following login prompt: CP0 Console Login:

Continue to the next task.

Logging in to the serial console port

To log in to the SAN384B-2 through the serial connection, follow these steps.

1. Log in to the SAN384B-2 as **admin**. The default password is "**password**." At the initial login, you are prompted to change the default passwords. Record the new passwords and keep this information in a secure location. The example below shows the login without changing the password.

```
swDir login: admin
Password:
Please change your passwords now.
Use Control-C to exit or press 'Enter' key to proceed.
```

```
Password was not changed. Will prompt again at next login
until password is changed.
swDir:admin>
```

2. (Optional) Modify passwords. To skip modifying the password, press **Ctrl+C**. Passwords can be 8 to 40 characters long. They must begin with an alphabetic character. They can include numeric characters, the dot (.), and the underscore (_). Passwords are case-sensitive, and they are not displayed when you enter them on the command line. For more information on passwords, refer to the *Fabric OS Administrator's Guide*.

Configuring the IP addresses

The SAN384B-2 requires three IP addresses, which are configured using the **ipAddrSet** command. IP addresses are required for both CP blades (CP0 and CP1) and for the chassis management IP (displayed under SWITCH with the **ipAddrShow** command).

Note: The default IP addresses and host names for the SAN384B-2 are as follows:

- 10.77.77.75 for CP0 (the CP blade in slot 4 at the time of configuration)
- 10.77.77.74 for CP1 (the CP blade in slot 5 at the time of configuration)

Attention: Resetting an IP address while the SAN384B-2 has active IP traffic such as Fabric Manager, Fabric Watch, SNMP, or other applications can cause traffic to be interrupted or stopped. Changing the IP address causes a domain address format RSCN to be issued.

Follow these steps to configure the IP addresses for both CP blades (from the active CP blade):

1. Log in to the active CP as **admin** using the serial cable connection.
2. Set up the SAN384B-2 IP address by entering the **ipaddrset -chassis** command at the prompt.

```
swDir:admin> ipAddrSet -chassis
```

Enter the information at the prompts. Specify the **-chassis IP** address. The **-sw 0** IP address is not valid on this chassis.

Note: The addresses 10.0.0.0 through 10.0.0.255 are reserved and used internally by the SAN384B-2. External IPs must not use these addresses.

3. Set up the CP0 blade IP address by entering the **ipaddrset -cp 0** command at the prompt.

```
swDir:admin> ipAddrSet -cp 0
```

Enter the requested information at the prompts.

4. Set up the CP1 IP address by entering the **ipaddrset -cp 1** command:swDir:admin> **ipAddrSet -cp 1**

Enter the requested information at the prompts.

The following is a sample IP configuration, for the SAN384B-2 (sw -0) and the two CP blades (cp0 and cp1):

```
swDir:admin> ipaddrset -chassis
Ethernet IP Address [0.0.0.0]: 192.168.1.1
Ethernet Subnetmask [0.0.0.0]: 255.255.255.0
Fibre Channel IP Address [0.0.0.0]:
Fibre Channel Subnetmask [0.0.0.0]:
Issuing gratuitous ARP...Done.
Committing configuration...Done.
swDir:admin> ipaddrset -cp 0
Host Name [cp0]:
Ethernet IP Address [10.77.77.75]: 192.168.1.2
Ethernet Subnetmask [0.0.0.0]: 255.255.255.0
Gateway IP Address [0.0.0.0]: 192.168.1.254
IP address is being changed...Done.
Committing configuration...Done.
swDir:admin> ipaddrset -cp 1
Host Name [cp1]:
Ethernet IP Address [10.77.77.74]: 192.168.1.3
Ethernet Subnetmask [0.0.0.0]: 255.255.255.0
Gateway IP Address [0.0.0.0]: 192.168.1.254
IP address of remote CP is being changed...Done.
Committing configuration...Done.
```

Logging off the serial console port and disconnecting the serial cable

You can use the serial port to monitor error messages through the serial connection, however it is generally used for initial configuration and service purposes. If the serial port is no longer required, use the **logout** command to log out of the serial console, remove the serial cable, and replace the plug in the serial port.

Establishing an Ethernet connection

After using a serial connection to configure the IP addresses for the SAN384B-2, you can connect the active CP blade to the local area network (LAN).

Note: Connecting the CP blades to a private network/VLAN is recommended.

By establishing an Ethernet connection, you can complete the SAN384B-2 configuration using a serial session, Telnet, or through a management application such as Web Tools or Network Advisor.

To establish an Ethernet connection to the SAN384B-2, follow these steps:

1. Remove the shipping plug from the Ethernet port on the active CP blade.
2. Insert one end of an Ethernet cable into the Ethernet port.
3. Connect the other end to an Ethernet 10/100/1000 BaseT LAN.

The SAN384B-2 can now be accessed by remote connection using the command line through Telnet or any of the management tools, such as Web Tools or Network Advisor.

4. To complete any additional SAN384B-2 configuration procedures through a Telnet session, log in to the SAN384B-2 by Telnet, using the **admin** login. The default password is **password**.

Customizing the switch name

The switch name of the SAN384B-2 can be up to 30 characters long; can include letters, numbers, and underscore characters; and must begin with a letter.

Note: Changing the name causes a domain address format RSCN to be issued.

To customize the name, follow these steps:

1. Enter the **switchName** command followed by the new name in quotes.

```
swDir:admin> switchName "ModularSwitch5"  
Committing configuration...  
Done.  
ModularSwitch5:admin
```

2. Record the new name for future reference.

Customizing a chassis name

The chassis name of the SAN384B-2 can be up to 15 characters long; can include letters, numbers, hyphens, and underscore characters; and must begin with a letter.

1. Enter **chassisName** followed by the new name in double quotes.

```
switch:admin> chassisname "SAN384B2_chassis_1"  
Committing configuration...  
Done.
```

2. To display the new chassis name, enter the **chassisName** command.

```
switch:admin> chassisname  
SAN384B2_chassis_1
```

3. Record the new name for reference.

Setting the Domain ID

Each switch in the fabric must have a unique Domain ID. The Domain ID can be set using the **configure** command or can be automatically set. The default Domain ID for the SAN384B-2 is "1". Use the **fabricShow** command to view the already assigned domain IDs.

To set the Domain ID, follow these steps:

1. Enter the **switchDisable** command to disable the SAN384B-2.
2. Enter the **configure** command.
3. Enter **y** at the "Fabric parameters" prompt:

```
Fabric parameters (yes, y, no, n): [no] y
```

4. Enter a unique Domain ID:

```
Domain: (1.239) [1] 3
```

5. Complete the remaining prompts or press **Ctrl+D** to accept the settings and to exit.
6. Enter the **switchEnable** command to re-enable the SAN384B-2.

Setting the date and time

The date and time settings are used for logging events. Switch operation does not depend on the date and time; a switch with an incorrect date and time value still functions properly. However, because the date and time are used for logging, error detection, and troubleshooting, they should be set correctly.

Setting the date

To set the date, follow these steps.

1. If necessary, log on to the SAN384B-2 by Telnet, using the **admin** account. The default password is **password**.
2. Enter the **date** command, using the following syntax: `date "mmddHHMMyy"`
Where:
 - mm is the month; valid values are 01 through 12.
 - dd is the date; valid values are 01 through 31.
 - HH is the hour; valid values are 00 through 23
 - MM is minutes; valid values are 00 through 59.
 - yy is the year; valid values are 00 through 99 (values greater than 69 are interpreted as 1970 through 1999, and values less than 70 are interpreted as 2000-2069).

```
switch:admin> date
Fri Sep 24 17:01:48 UTC 2010
switch:admin> date "0927123010"
Mon Sep 27 12:30:00 UTC 2010
switch:admin>
```

Setting the time zone

You must perform the procedure on all chassis for which the time zone must be set. However, you only need to set the time zone once on each switch, because the value is written to nonvolatile memory. Use one of the two following procedures to set the time zone.

The following procedure describes how to set the current time zone using **timezone_fmt** mode to Central Standard time.

1. Log on to the chassis using the **admin** account. The default password is **password**
2. Enter the **tsTimeZone** command as follows:

```
switch:admin> tstimezone [--interactive]/ [, timezone_fmt]
```

Use **timezone_fmt** to set the time zone by Country/City or by time zone ID, such as PST. The following example shows how to change the time zone to US/Central.

```
switch:admin> tstimezone
Time Zone : US/Pacific
switch:admin> tstimezone US/Central
switch:admin> tstimezone
Time Zone : US/Central
```

The following procedure describes how to set the current time zone using interactive mode to Pacific Standard Time.

1. Enter the **tsTimeZone** command as follows:
switch:admin> **tstimezone --interactive**
2. You are prompted to select a general location.
Please identify a location so that time zone rules can be set correctly.
3. Enter the appropriate number or **Ctrl+D** to quit.
4. At the prompt, select a **country location**.
5. At the prompt, enter the appropriate number to specify the time zone region or **Ctrl+D** to quit.

Synchronizing local time

To synchronize the local time of the principal or primary switch with that of an external NTP server, follow these steps.

1. If necessary, log on to the switch by Telnet, using the **admin** account.
2. Enter the **tsClockServer** command:

```
switch:admin> tsclockserver "<ntp1;ntp2>"
```

where **ntp1** is the IP address or DNS name of the first NTP server, which the switch must be able to access. The variable **ntp2** is the second NTP server and is optional. The operand "**<ntp1;ntp2>**" is optional; by default, this value is **LOCL**, which uses the local clock of the principal or primary switch as the clock server.

The **tsClockServer** command accepts multiple server addresses in either IPv4, IPv6, or DNS name formats. When multiple NTP server addresses are passed, **tsclockserver** sets the first obtainable address as the active NTP server. The rest

will be stored as backup servers that can take over if the active NTP server fails. The principal or primary FCS switch synchronizes its time with the NTP server every 64 seconds.

```
switch:admin> tsclockserver  
LOCL  
switch:admin> tsclockserver "132.163.135.131"  
switch:admin> tsclockserver  
132.163.135.131  
switch:admin>
```

The following example shows how to set up more than one NTP server using a DNS name:

```
switch:admin> tsclockserver "10.32.170.1;10.32.170.2;ntp.localdomain.net"  
Updating Clock Server configuration...done.  
Updated with the NTP servers
```

Changes to the clock server value on the principal or primary FCS switch are propagated to all switches in the fabric

Verifying the persistent PID feature

Before connecting the SAN384B-2 to the fabric, verify that the WWN Based persistent port identifier (PID) feature on the SAN384B-2 matches the other switches in the fabric. This parameter must be identical for all switches in the fabric and is set using the configure command as shown below:

```
switch:admin>configure  
Configure...  
Fabric parameters (yes, y, no, n): [no] y  
Domain: (1..239) [1]  
Enable a 256 Area Limit  
(0 = No,  
 1 = Zero Based Area Assignment,  
 2 = Port Based Area Assignment): (0..2) [0] 1  
WWN Based persistent PID (yes, y, no, n): [no] yes  
<command output truncated>
```

You can check the PID setting using the **configshow** command as in the following example. You can use the **| grep -i pid** qualifier to pinpoint the PID information.

```
switch:admin> configshow | grep -i pid  
fabric.ops.mode.pidFormat:1  
fabric.wwnPidMode:1
```

The 1 indicates that the WWN Based persistent PID feature is enabled. The default value is 0 for disabled.

Determining installed software licenses

Certain licenses may be factory installed on the SAN384B-2. To determine which licenses are currently enabled, use the **licenseShow** command.

```
swDir:admin> licenseshow  
AAbbccDDeeFFeeGG:  
  Web license  
  Zoning license  
  Extended Fabric license  
  Fabric Watch license  
  Performance Monitor license  
  Trunking license  
  Security license
```

In the example above, the license key is *AAbbccDDeeFFeeGG*. Keep a copy of the license key for reference.

The 64-bit chassis ID is required to obtain and activate licenses for the SAN384B-2. The chassis ID is available through the **licenseIdShow** command.

The **licenseShow** and **licenseIdShow** commands must be entered on the active CP blade.

Refer to the *Fabric OS Administrator's Guide* for more information.

Installing transceivers and attaching cables

The following two sets of steps cover the installation of transceivers and cables for most SFPs and for QSFPs.

Note: For a listing of transceivers compatible with this product:

- Go to the IBM SAN web page www.ibm.com/systems/storage/san
- Select the **IBM System Storage SAN768B-2 and SAN384B-2** product link
- On the displayed product page, click the **Interoperability Matrix** link in the **Learn more** section.
- In the Interoperability matrix, click the **Transceivers** link.

Follow the first set of steps to install SFP+s and mSFPs (FC8-64 port card only) and cables to the SAN384B-2 (see “Removing and installing transceivers” on page 89 for more details). Follow the second set of steps to install the QSFP transceivers and cables in the core blades for inter-chassis link connections (see “Removing and replacing inter-chassis link (QSFP) cables” on page 93 for more details).

Attention: mSFP transceivers are compatible only with the FC8-64 port blade. While they will fit in other blades, this configuration is unsupported and will generate an error.

The ports are color-coded to indicate which can be used in the same port group for trunking (trunking port groups can be up to eight ports). The ports and cables used in trunking groups must meet specific requirements. Refer to the *Fabric OS Administrator's Guide* for more information.

Follow these steps to add the optical transceivers and cables to the Fibre Channel ports.

1. Position one of the optical transceivers so that the key is oriented correctly to the port. Insert the transceiver into the port until it is firmly seated and the latching mechanism clicks.

Transceivers are keyed so that they can only be inserted with the correct orientation. If a transceiver does not slide in easily, ensure that it is correctly oriented.

2. Position a cable so that the key (the ridge on one side of the cable connector) is aligned with the slot in the transceiver; then, insert the cable into the transceiver until the latching mechanism clicks.

Cables are keyed so that they can only be inserted with the correct orientation. If a cable does not slide in easily, ensure that it is correctly oriented.

3. Repeat steps 1 and 2 for the remaining ports.
4. Organize the cables as required. For recommendations regarding cable management, refer to “Managing cables” on page 44.
5. Verify the chassis and port status using the **switchShow** command.
6. Verify fabric connectivity using the **fabricShow** command.

Follow these steps to install the QSFPs and cables in the 16 Gbps core blades. These transceivers and cables are used to form the inter-chassis links (ICL) with neighboring SAN384B-2 and SAN768B-2 backbones. The transceivers should be installed in the blades before connecting the cables. Because each QSFP contains four 16 Gbps ports, be aware that any problems with one port could affect all four ports in the quad if the QSFP has to be replaced.

1. Position one of the QSFP transceivers so that the key is oriented correctly to the port. Insert the transceiver into the port until it is firmly seated. Transceivers are keyed so that they can only be inserted with the correct orientation. If a transceiver does not slide in easily, ensure that it is correctly oriented. When the transceiver is correctly seated, the status LED will flash amber several times and then turn solid amber.
2. Remove the protective cap from the special QSFP cable and insert it into the transceiver until it is firmly seated. The cables are also keyed to fit into the transceivers correctly. When the cable is correctly seated, the status LED will change from amber to green.
3. Repeat steps 1 and 2 for the remaining ICLs.
4. Organize the cables (see “Managing cables” on page 44).
5. Verify the chassis and connector and port status using the `switchShow -qsfp` command. A sample of the command output is shown below. The example is from a SAN384B-2 with a core blade installed in slot 3. Note that the state reported for an unconnected QSFP (shown QSFP 0 and Ports 0-3 below) is No_SigDet. This is different from the State of No_Synch that is reported for regular SFPs that are unconnected. QSFP 7 (ports 3/28-3/31, Index 748-751) in the following example shows the results for a connected QSFP.

```
switch:FID128:admin> switchshow -qsfp
switchName: switch_name
switchType: 121.3
switchState: Online
switchMode: Native
switchRole: Subordinate
switchDomain: 75
switchId: fffc4b
switchWwn: 10:00:00:05:1e:4f:eb:00
zoning: ON (zoning_name)
switchBeacon: OFF
FC Router: OFF
Allow XISL Use: OFF
LS Attributes: [FID: 128, Base Switch: No, Default Switch: Yes, Address Mode
0]
```

Index	Slot	Port	QSFP	Address	Media	Speed	State	Proto
256	3	0	0	-----	id	16G	No_SigDet	FC
257	3	1	0	-----	id	16G	No_SigDet	FC
258	3	2	0	-----	id	16G	No_SigDet	FC
259	3	3	0	-----	id	16G	No_SigDet	FC
260	3	4	1	-----	--	16G	No_Module	FC
261	3	5	1	-----	--	16G	No_Module	FC
262	3	6	1	-----	--	16G	No_Module	FC
263	3	7	1	-----	--	16G	No_Module	FC
264	3	8	2	-----	--	16G	No_Module	FC
265	3	9	2	-----	--	16G	No_Module	FC
266	3	10	2	-----	--	16G	No_Module	FC
267	3	11	2	-----	--	16G	No_Module	FC
268	3	12	3	-----	--	16G	No_Module	FC
269	3	13	3	-----	--	16G	No_Module	FC
270	3	14	3	-----	--	16G	No_Module	FC
271	3	15	3	-----	--	16G	No_Module	FC
736	3	16	4	-----	--	16G	No_Module	FC
737	3	17	4	-----	--	16G	No_Module	FC

```

738 3 18 4 ----- -- 16G No_Module FC
739 3 19 4 ----- -- 16G No_Module FC
740 3 20 5 ----- -- 16G No_Module FC
741 3 21 5 ----- -- 16G No_Module FC
742 3 22 5 ----- -- 16G No_Module FC
743 3 23 5 ----- -- 16G No_Module FC
744 3 24 6 ----- -- 16G No_Module FC
745 3 25 6 ----- -- 16G No_Module FC
746 3 26 6 ----- -- 16G No_Module FC
747 3 27 6 ----- -- 16G No_Module FC
748 3 28 7 ----- id 16G Online FC E-Port
10:00:00:05:1e:39:e4:5a trunk master_name (Trunk master)
749 3 29 7 ----- id 16G Online FC E-Port
10:00:00:05:1e:39:e4:5a trunk master_name (Trunk master)
750 3 30 7 ----- id 16G Online FC E-Port
10:00:00:05:1e:39:e4:5a trunk master_name (Trunk master)
751 3 31 7 ----- id 16G Online FC E-Port
10:00:00:05:1e:39:e4:5a trunk master_name (Trunk master)

```

Managing cables

Attention: The minimum bend radius should be no smaller than 10x the cable radius. The minimum bend radius for a 50 micron cable is 5.1 cm (2 in.) under full tensile load and 3 cm (1.2 in.) with no tensile load.

Note: Contact your IBM representative for options regarding different cable and patch panel configurations to simplify cable management with higher density FC8-64 port blades.

Cable management recommendations:

- Leave at least 1 m (3.28 ft) of slack for each port cable. This provides room to remove and replace blades in the chassis, allows for inadvertent movement of the rack, and helps prevent the cables from being bent to less than the minimum bend radius.
- If ISL Trunking is in use, group the cables by trunking group. The ports are color-coded to indicate which ports can be used in the same ISL Trunking group: eight ports marked with solid black ovals alternate with eight ports marked with oval outlines.
- Use only hook-and-loop fasteners for securing optical cables. Do not use cable ties. They can be easily overtightened and can damage the optical cables.
- For easier maintenance, label the fiber optic cables and record the devices to which they are connected.
- Use the cable management fingers attached to the rack rails to organize the cables off to the side of the chassis, and away from the chassis exhaust vents.
- Keep LEDs visible by routing port cables and other cables away from the LEDs.

For the procedure to install the ICL cables see “Removing and replacing inter-chassis link (QSFP) cables” on page 93.

Planning for encryption (optional)

Encryption is an optional feature available on the SAN384B-2 through the installation and use of the FS8-18 encryption blade. Advance planning is essential to achieve a successful implementation of encryption.

Attention: Setup of the FS8-18 blade for encryption requires the use of this document for the physical installation of the blade. Critical information required for enabling and managing encryption is contained in the *Fabric OS Encryption Administrator's Guide Supporting Tivoli Key Lifecycle Manager (TKLM) Environments*, which is included on the documentation CD-ROM that is shipped with the product. You must use both documents in order to successfully set up the switch for encryption.

Careful attention to details of setup and configuration are essential to enabling a secure encryption functionality. The following guidelines should be followed when planning for encryption with the 16-port encryption blade (FS8-18), which is available for the SAN768B, SAN768B-2, SAN384B, and SAN384B-2 products, or the SAN32B-E4.

- Redundancy of hardware is essential because if the encryption path is disrupted, access to the encrypted data will be lost with a single encryption device. You must have two encryption devices to ensure backup and access in the event that one of the devices goes down. If one of the devices in the encryption pair is not functioning, you will only have read access to the encrypted data on the functioning device until the non-functioning device is restored. Redundancy of hardware for encryption can be accomplished with the following:
 - Two Key Vault locations on different devices
 - Two encryption devices in any combination of encryption switches (SAN32B-E4) and FS8-18 encryption blades (in SAN768B, SAN768B-2, SAN384B, or SAN384B-2 chassis)
- Cable planning for the encryption switch and its back-up and for a primary and secondary key vault manager is critical. These devices can be separated by distance as long as they can maintain constant communication contact. One device must back up the other to ensure access to encrypted data. Refer to the *Fabric OS Encryption Administrator's Guide Supporting Tivoli Key Lifecycle Manager (TKLM) Environments* for more information on Master Keys (MK).
- Begin with a limited application of encryption in a test environment and once an expanded encryption test is successful, move the encryption into production
- Avoid dual encryption (Fabric encryption and device encryption). While this should not cause any encryption errors, it will degrade performance.
- There is no support of Cisco switches at this time by IBM. The section in the *Fabric OS Encryption Administrator's Guide Supporting Tivoli Key Lifecycle Manager (TKLM) Environments* related to Cisco Fabric connectivity does not currently apply.
- The use of Smart Cards provides additional encryption security management, and is highly recommended. Smart cards can be ordered as FRUs through IBM.
- The Top Talker feature is not compatible with redirection zones. The Top Talker feature should not be enabled when an encryption switch or blade is present in the fabric.
- Alias zoning is not supported in encryption environments. You must use the real WWPN.

- Refer to the "Steps for connecting to a TKLM appliance" section of the *Fabric OS Encryption Administrator's Guide Supporting Tivoli Key Lifecycle Manager (TKLM) Environments* for detailed information on initial setup. That section includes the following information:
 - All switches you plan to include in an encryption group must have a secure connection to the Tivoli Key Lifecycle Manager (TKLM). A local LINUX host must be available to transfer certificates.
 - Be sure that the clock time on the TKLM server and on the Brocade encryption nodes are the same. A difference of only a few minutes can cause the TLS connectivity to fail.
 - Repeat the same steps for configuring both the primary and the secondary key vault.
 - Both the primary and secondary key vaults should be registered before exporting MK or encrypting LUNs. If the secondary key vault is registered midway after encryption is done for some of the LUNs, then the key database should be backed up and restored on the secondary TKLM from the already registered primary TKLM before registering the secondary TKLM.
 - The following is a suggested order for the initial steps needed to create a secure connection to TKLM. (Refer to the "Steps for connecting to a TKLM appliance" section of the *Fabric OS Encryption Administrator's Guide Supporting Tivoli Key Lifecycle Manager (TKLM) Environments* for additional steps.)
 1. Initialize all encryption nodes to generate Key authentication center (KAC) certificates and export the signed KAC certificates to a local LINUX host.
 2. Obtain the necessary user credentials and log in to the TKLM server appliance from the TKLM management web console.

Configuring for encryption (optional)

Summary of procedure

The optional FS8-18 encryption blade requires configuration to enable the configuration functions. This section provides a brief overview of those configuration steps. Refer to the *Fabric OS Encryption Administrator's Guide (TKLM Key Management)* for the detailed procedures to configure the encryption functions.

Note:

If the encryption blade (FS8-18) is being configured for the first time for encryption services, you will need to perform several pre-initialization tasks related to configuring the encryption node (switch), including:

- Generating the Critical Security Parameters (CSPs) and certificates
- Loading and setting up the certificates
- Establishing a trusted link (LKM Appliance)
- Configuring the global parameters and policies of the encryption group
- Generating and backing up the master key in RSA environments
- Handling key-vault high-availability
- Configuring cluster interconnect

After completing the pre-initialization tasks, you may need to perform several tasks related to configuring the encryption group. Figure 18 on page 47 summarizes the flow of the encryption-configuration tasks.

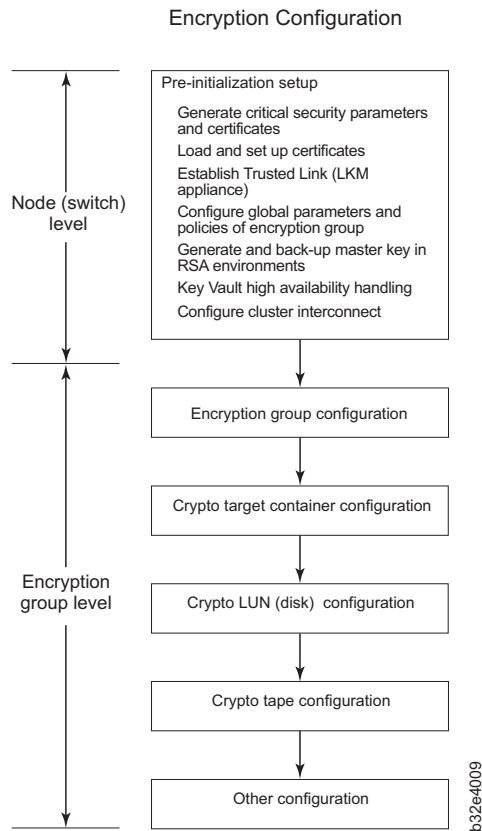

Figure 18. Encryption configuration

Avoid double encryption

Encryption and decryption at the storage device level does not affect the encryption switch or blade capabilities, and does not cause problems with decrypting the data. However, double encryption adds the unnecessary need to manage two sets of encryption keys, increases the risk of losing data, may reduce performance, and does not add security.

Verifying correct operation and backing up the configuration

To verify correct operation and to back up the system, follow these steps.

1. Check the LEDs to verify that all components are functional. For information about LED patterns, see Chapter 4, “Monitoring system components,” on page 51.
2. If necessary, log on to the switch by Telnet, using the **admin** account.
3. Verify the correct operation of the system by entering the **switchShow** command from the workstation. This command provides information about switch and port status.
4. Verify the correct operation of the SAN384B-2 in the fabric by entering the **fabricShow** command from the workstation. This command provides general information about the fabric.
5. To back up the configuration, run the following two steps:
 - a. Enter the **configupload -vf** command. This command uploads the system virtual fabric data.

- b. Enter the **configupload** command. This command uploads the system configuration.
6. Run the following commands to see additional configuration information that you can then copy to a file to save:
 - **configShow**
 - **ipAddrShow**
 - **licenseShow**
 - **switchShow**

Alternatively, you can save the configuration file to the USB device by using the **usbstorage** command.

Note: Passwords are not saved in the configuration file, and are not uploaded during a **configUpload**. Password information should be saved in hardcopy in a secure location for reference, subject to your security and password management policy.

Note: It is recommended that the configuration be backed up on a regular basis to ensure that a complete configuration is available for downloading to a replacement device.

Fabric OS firmware updates

To ensure optimum functioning of your system, IBM recommends operating your system with the latest Fabric OS version and firmware updates. Refer to the latest Fabric OS Release Notes and Interoperability Matrix for information regarding Fabric OS compatibility. This is particularly important for fabrics with 1-Gbps switches using earlier Fabric OS versions. Detailed information on downloading and installing firmware are provided in “Downloading firmware from an FTP server” on page 78 and “Downloading firmware from a USB device” on page 80. More information can also be found in the *Fabric OS Administrator’s Guide*.

To access the appropriate matrix:

- Go to the IBM SAN web page www.ibm.com/systems/storage/san
- Select the **SAN768B-2 and SAN384B-2** product link
- On the displayed product page, click the **Interoperability Matrix** link in the **Learn more** section.

Firmware release notes and download files are available through the IBM Support Portal.

To view release notes and to download firmware:

- Go to the IBM Support Portal www.ibm.com/supportportal.
- Search for the product Machine type, 2499 or the product name.
- On the next page that is displayed, select **Download** under the **Task** section.
- From the displayed page, select the **Release notes** link. Review the release notes of the appropriate release version before installing the firmware update.
- Click the **Release Firmware** link and follow the online prompts to navigate to the **Brocade Downloads for IBM End Users** page.
- Follow the links and instructions on the Brocade pages. Note that associated FOS documentation can also be downloaded from this site.

Downloading and installing firmware

See “Downloading firmware from an FTP server” on page 78 and “Downloading firmware from a USB device” on page 80 for detailed steps to download and install firmware on the CP blades.

1. The firmware version on both the active and backup CP blade should match, and should be at the latest level. If High Availability is enabled (**haEnable**), the system will automatically update the firmware level on both CP blades.
Attention: Firmware downloads require Ethernet connections to both CP blades. Procedures for downloading and installing firmware are fully described in the *Fabric OS Administrator's Guide*.
2. When you have navigated to the appropriate download site, follow the online instructions on the displayed Fabric OS download pages, referring to the *Fabric OS Administrator's Guide* as needed.
3. Enter **firmwareDownload -s** on your to download the firmware to one of the CP blades from your server.

Powering off the SAN384B-2

If you need to power off the system, follow these steps to avoid loss of data.

1. Shut down the system using the **sysShutdown** command.

```
switch::admin> sysshutdown
This command will shutdown the operating systems on your switch.
You are required to power-cycle the switch in order to restore operation.
Are you sure you want to shutdown the switch [y/n]? y
HA is disabled
Stopping blade 1
Shutting down the blade....
Stopping blade 2
Shutting down the blade....
Stopping blade 8
Shutting down the blade....
Broadcast message from root (pts/1) Tue Aug 23 14:23:06 2011...
The system is going down for system halt NOW !!
```
2. Power off the chassis by flipping the AC power switches on the power supplies to "O". The LEDs inside AC power switches should turn off. To maintain the ground connections, leave the power cords connected to the power supplies and to the electrical outlets.

Chapter 4. Monitoring system components

The SAN384B-2 is engineered for reliability and requires no routine operational steps or maintenance. This chapter provides information about determining the status of the following components using LEDs and CLI commands. Refer to the *Fabric OS Administrator's Guide* and the *Web Tools Administrator's Guide* for more information on monitoring component status.

There are two commands that can be especially helpful in monitoring the health of the system. These commands are **switchShow** and **chassisShow**. Examples of these commands are shown below. Note in the **switchShow** command the new switchType for the SAN384B-2 as well as the 16 Gbps speed identification for capable ports. The output has been truncated to reduce information duplication.

```
SAN384B-2_130: admin> switchshow
switchName: SAN384B-2
switchType: 121.3
switchState: Online
switchMode: Native
switchRole: Principal
switchDomain: 130
switchId: fffc82
switchWwn: 10:00:00:05:33:03:2c:00
zoning: ON (BB)
switchBeacon: OFF
FC Router: ON
FC Router BB Fabric ID: 10
Address Mode: 0
Index Slot Port Address Media Speed State Proto
=====
  0  1  0  820000 id N8 Online FC F-Port
10:00:00:05:1e:f8:a0:b4
  1  1  1  820100 id N8 Online FC F-Port
10:00:00:05:33:26:0e:65
  2  1  2  820200 id N8 Online FC F-Port
10:00:00:05:33:48:5e:f5
  3  1  3  820300 id N8 Online FC F-Port
10:00:00:05:1e:f8:a0:b3
  4  1  4  820400 id N8 Online FC F-Port
10:00:00:05:33:26:10:15
  5  1  5  820500 id N8 Online FC F-Port
10:00:00:05:1e:f8:a0:b1
  6  1  6  820600 id N8 Online FC F-Port
10:00:00:05:33:48:5e:d0
  7  1  7  820700 id N8 Online FC F-Port
10:00:00:05:33:26:df:6b
  8  1  8  820800 id N8 Online FC F-Port
10:00:00:05:33:26:df:6a
  9  1  9  820900 id N8 Online FC F-Port
10:00:00:05:33:48:6b:ea
 10  1 10  820a00 id N8 Online FC F-Port
10:00:00:05:33:26:10:28
 11  1 11  820b00 id N8 Online FC F-Port
10:00:00:05:33:26:10:73
 12  1 12  820c00 id N8 Online FC F-Port
10:00:00:05:33:48:5e:d1
 13  1 13  820d00 id N8 Online FC F-Port
10:00:00:05:33:26:10:29
 14  1 14  820e00 id N8 Online FC F-Port
10:00:00:05:1e:f9:72:47
 15  1 15  820f00 id N8 Online FC F-Port
```

```

10:00:00:05:33:26:0e:8a
 16 1 16 821000 id N8 Online FC F-Port
10:00:00:05:33:26:0e:8b
 17 1 17 821100 id N8 Online FC F-Port
10:00:00:05:33:48:6b:eb
 18 1 18 821200 id N8 Online FC F-Port
10:00:00:05:1e:f9:72:46
 19 1 19 821300 id N8 Online FC F-Port
10:00:00:05:33:26:10:14
 20 1 20 821400 id N8 Online FC F-Port
10:00:00:05:33:26:0e:64
 21 1 21 821500 id N8 Online FC F-Port
10:00:00:05:33:26:10:72
 22 1 22 821600 id N8 Online FC F-Port
10:00:00:05:33:48:5e:f4
 23 1 23 821700 id N8 Online FC F-Port
10:00:00:05:1e:f8:a0:b2
 24 1 24 821800 -- N16 No_Module FC
 25 1 25 821900 -- N16 No_Module FC
 26 1 26 821a00 -- N16 No_Module FC
 27 1 27 821b00 -- N16 No_Module FC
 28 1 28 821c00 id N8 No_Light FC
 29 1 29 821d00 id N8 No_Light FC
 30 1 30 821e00 id N8 No_Light FC
 31 1 31 821f00 id N8 No_Light FC
 32 1 32 822000 id N8 No_Light FC
 33 1 33 822100 id N8 No_Light FC
 34 1 34 822200 id N8 No_Light FC
 35 1 35 822300 id N8 No_Light FC
 36 1 36 822400 id N8 No_Light FC
 37 1 37 822500 id N8 No_Light FC
 38 1 38 822600 id N8 No_Light FC
 39 1 39 822700 id N8 No_Light FC
 40 1 40 822800 id N8 No_Light FC
 41 1 41 822900 id N8 No_Light FC
 42 1 42 822a00 id N8 No_Light FC
 43 1 43 822b00 id N8 No_Light FC
 44 1 44 822c00 id N8 No_Light FC
 45 1 45 822d00 -- N16 No_Module FC
 46 1 46 822e00 -- N16 No_Module FC
 47 1 47 822f00 -- N16 No_Module FC
256 3 0 ----- id 16G No_SigDet FC
257 3 1 ----- id 16G No_SigDet FC
258 3 2 ----- id 16G No_SigDet FC
259 3 3 ----- id 16G No_SigDet FC
260 3 4 ----- id 16G No_SigDet FC
261 3 5 ----- id 16G No_SigDet FC
262 3 6 ----- id 16G No_SigDet FC
263 3 7 ----- id 16G No_SigDet FC
264 3 8 ----- id 16G No_SigDet FC
265 3 9 ----- id 16G No_SigDet FC

```

<output truncated>

SAN384B-2_130:root

Note in the **chassisShow** command the Chassis Family designation for the SAN384B-2 along with specific information about every field-replaceable unit (FRU) in the chassis is displayed.

```
SAN384B-2_130:root> chassisshow
```

```
Chassis Family: SAN384B-2
Chassis Backplane Revision: 2
```

```
SW BLADE Slot: 1
Header Version: 2
Power Consume Factor: -160
Power Usage (Watts): -106
```

Factory Part Num: 60-1002144-02
Factory Serial Num: BQB0345F00X
Manufacture: Day: 19 Month: 11 Year: 2010
Update: Day: 29 Month: 3 Year: 2011
Time Alive: 32 days
Time Awake: 0 days

CP BLADE Slot: 4
Header Version: 2
Power Consume Factor: -40
Factory Part Num: 60-1000376-08
Factory Serial Num: AHJ0420F08K
Manufacture: Day: 21 Month: 5 Year: 2010
Update: Day: 29 Month: 3 Year: 2011
Time Alive: 229 days
Time Awake: 0 days

CP BLADE Slot: 5
Header Version: 2
Power Consume Factor: -40
Factory Part Num: 60-1000376-08
Factory Serial Num: AHJ0420F086
Manufacture: Day: 21 Month: 5 Year: 2010
Update: Day: 29 Month: 3 Year: 2011
Time Alive: 229 days
Time Awake: 0 days

CORE BLADE Slot: 3
Header Version: 2
Power Consume Factor: -135
Power Usage (Watts): -88
Factory Part Num: 60-1002142-02
Factory Serial Num: BQD0344F01K
Manufacture: Day: 18 Month: 11 Year: 2010
Update: Day: 29 Month: 3 Year: 2011
Time Alive: 47 days
Time Awake: 0 days

CORE BLADE Slot: 6
Header Version: 2
Power Consume Factor: -135
Power Usage (Watts): -87
Factory Part Num: 60-1002099-01
Factory Serial Num: BQD0337F00A
Manufacture: Day: 16 Month: 9 Year: 2010
Update: Day: 29 Month: 3 Year: 2011
Time Alive: 77 days
Time Awake: 0 days

AP BLADE Slot: 7
Header Version: 2
Power Consume Factor: -250
Factory Part Num: 60-1001157-21
Factory Serial Num: ATM0431F008
Manufacture: Day: 20 Month: 9 Year: 2010
Update: Day: 29 Month: 3 Year: 2011
Time Alive: 4 days
Time Awake: 0 days

SW BLADE Slot: 8
Header Version: 2
Power Consume Factor: -140
Power Usage (Watts): -95
Factory Part Num: 60-1002145-02
Factory Serial Num: BQA0344F00S
Manufacture: Day: 6 Month: 11 Year: 2010
Update: Day: 29 Month: 3 Year: 2011

Time Alive: 32 days
Time Awake: 0 days

POWER SUPPLY Unit: 1
Header Version: 2
Power Consume Factor: 2000
Factory Part Num: 23-0000067-01
Factory Serial Num: AGC2M03FR4P
Manufacture: Day: 7 Month: 6 Year: 2010
Update: Day: 29 Month: 3 Year: 2011
Time Alive: 229 days
Time Awake: 0 days

POWER SUPPLY Unit: 2
Header Version: 2
Power Consume Factor: 2000
Factory Part Num: 23-0000067-01
Factory Serial Num: AGC2M03FR7T
Manufacture: Day: 7 Month: 6 Year: 2010
Update: Day: 29 Month: 3 Year: 2011
Time Alive: 221 days
Time Awake: 0 days

FAN Unit: 1
Header Version: 2
Power Consume Factor: -126
Factory Part Num: 60-1000384-09
Factory Serial Num: AGB0623F0AM
Manufacture: Day: 7 Month: 6 Year: 2010
Update: Day: 29 Month: 3 Year: 2011
Time Alive: 229 days
Time Awake: 0 days

FAN Unit: 2
Header Version: 2
Power Consume Factor: -126
Factory Part Num: 60-1000384-09
Factory Serial Num: AGB0623F0AK
Manufacture: Day: 7 Month: 6 Year: 2010
Update: Day: 29 Month: 3 Year: 2011
Time Alive: 229 days
Time Awake: 0 days

WWN Unit: 1
Header Version: 2
Power Consume Factor: -1
Factory Part Num: 60-1000888-05
Factory Serial Num: ANN2524F01N
Manufacture: Day: 7 Month: 6 Year: 2010
Update: Day: 29 Month: 3 Year: 2011
Time Alive: 229 days
Time Awake: 0 days
ID: BRD0000CA
Part Num: SLKWRM0000X4S

WWN Unit: 2
Header Version: 2
Power Consume Factor: -1
Factory Part Num: 60-1000888-05
Factory Serial Num: ANQ0417F03P
Manufacture: Day: 7 Month: 6 Year: 2010
Update: Day: 29 Month: 3 Year: 2011
Time Alive: 229 days
Time Awake: 0 days

Chassis Factory Serial Num: ANP2523F00E
SAN384B-2_130:root>

The following sections provide information on how to determine the status of different chassis components by viewing the LEDs or by entering commands.

- “Port, application, or encryption blade status”
- “Control processor blade (CP8) status” on page 59
- “Core switch blade (CR16-4) status” on page 61
- “Power supply status” on page 63
- “Blower assembly status” on page 63
- “WWN card status” on page 65

Port, application, or encryption blade status

To determine the status of a port or application blade:

1. Check the LEDs on the blade. The illustrations show the blades oriented horizontally, as they are installed in the SAN384B-2 chassis.
 - Figure 19 illustrates the FC16-32 port blade
 - Figure 20 on page 56 illustrates the FC16-48 port blade
 - Figure 21 on page 56 illustrates the FC8-32E port blade
 - Figure 22 on page 56 illustrates the FC8-48E port blade
 - Figure 23 on page 57 illustrates the FC8-64 port blade
 - Figure 24 on page 57 illustrates the FS8-18 encryption blade
 - Figure 25 on page 58 illustrates the FX8-24 extension blade

The LED patterns may temporarily change during POST and other diagnostic tests. For information about how to interpret the LED patterns, see Table 8 on page 58.

2. Check the blade status by typing **slotShow**.

Table 8 on page 58 describes the port blade LED patterns and the recommended actions for those patterns.

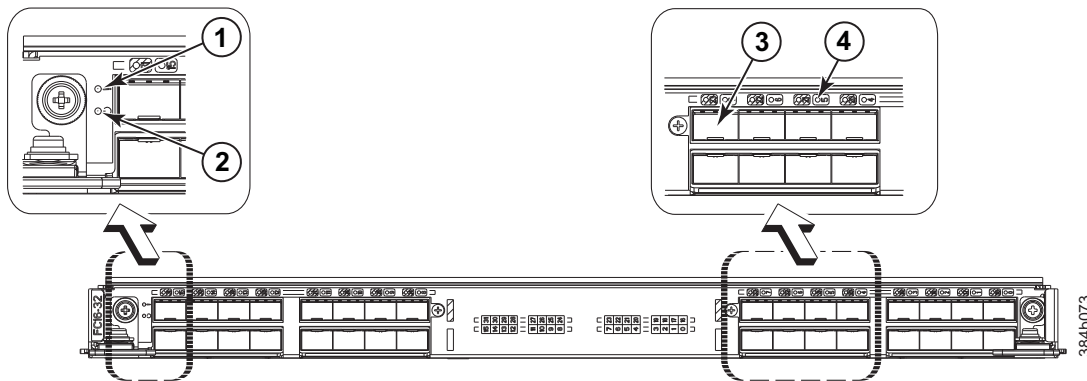

Figure 19. FC16-32 port blade

- | | | | |
|----------|------------|----------|--------------------|
| 1 | Status LED | 3 | Fibre Channel port |
| 2 | Power LED | 4 | Port status LED |

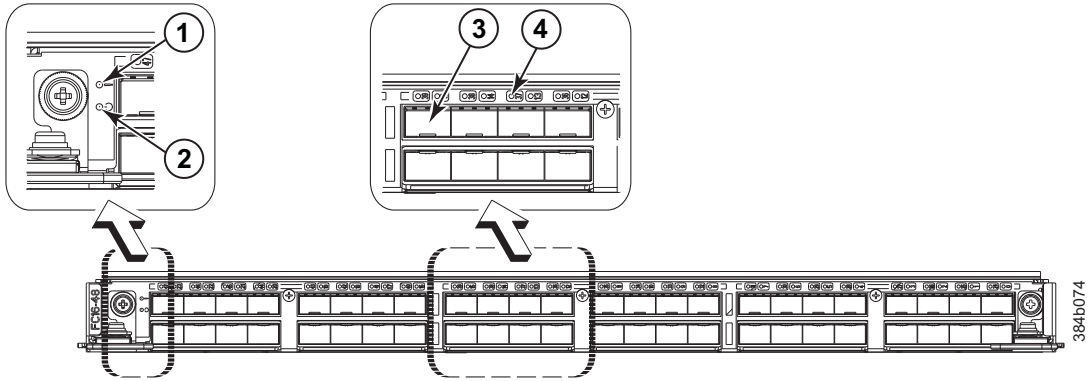

Figure 20. FC16-48 port blade

- | | | | |
|----------|------------|----------|--------------------|
| 1 | Status LED | 3 | Fibre Channel port |
| 2 | Power LED | 4 | Port status LED |

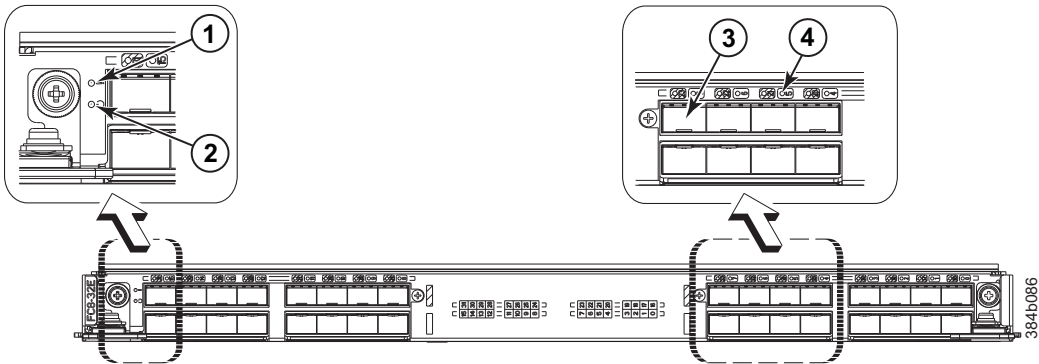

Figure 21. FC8-32E port blade

- | | | | |
|----------|------------|----------|--------------------|
| 1 | Status LED | 3 | Fibre Channel port |
| 2 | Power LED | 4 | Port status LED |

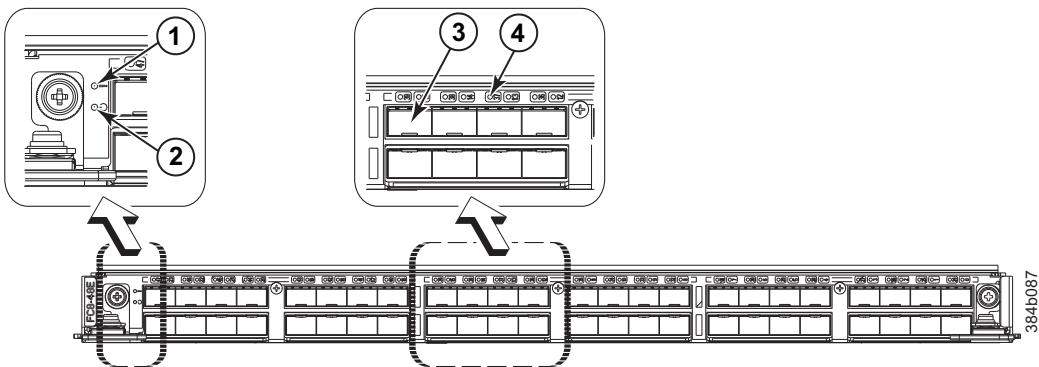

Figure 22. FC8-48E port blade

- | | | | |
|----------|------------|----------|--------------------|
| 1 | Status LED | 3 | Fibre Channel port |
|----------|------------|----------|--------------------|

2 Power LED

4 Port status LED

Note: The FC8-64 port blade requires mSFPs (standard SFPs do not fit) as well as narrower OM-3 LC cables offered by several major manufacturers.

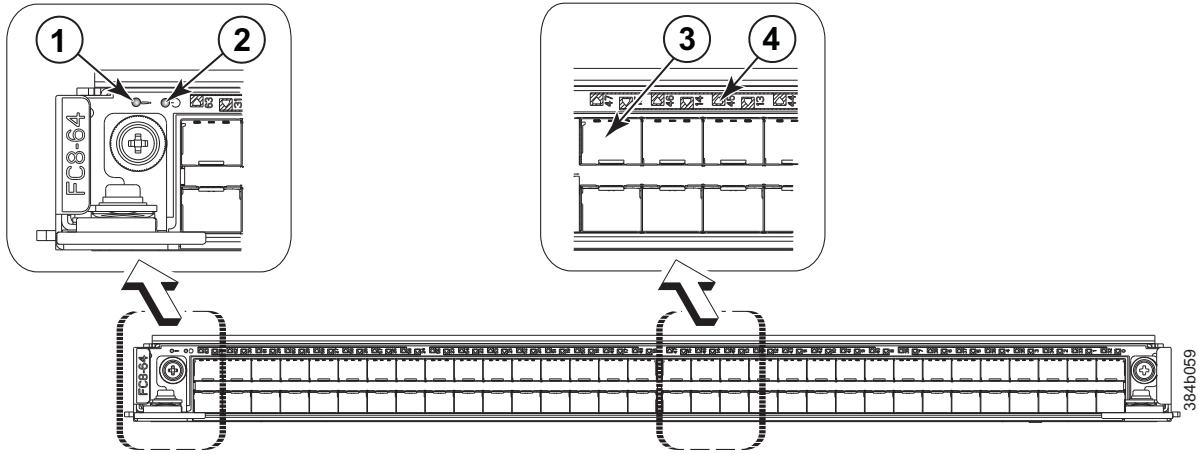

Figure 23. FC8-64 port blade

1 Status LED

3 Fibre Channel port

2 Power LED

4 Port status LED

Note: The FC8-64 port blade requires mSFPs (standard SFPs do not fit) as well as narrower OM-3 LC cables offered by several major manufacturers.

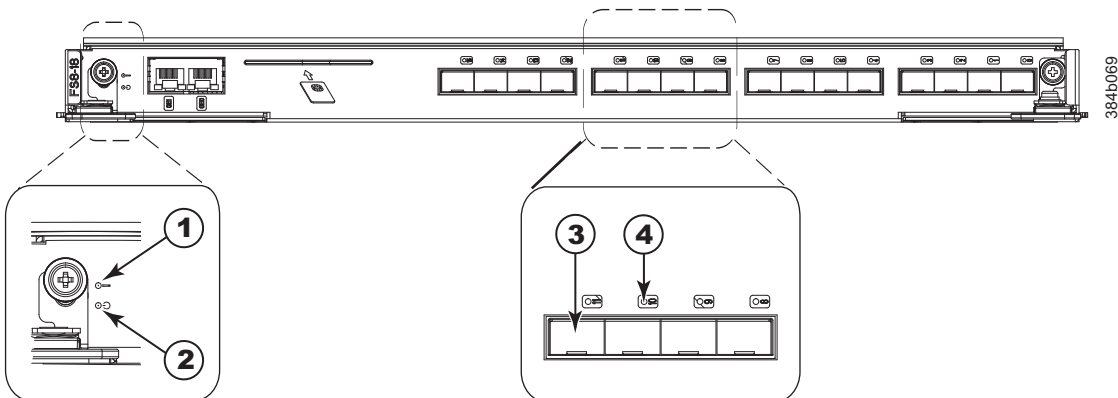

Figure 24. FS8-18 encryption blade

1 Status LED

3 Fibre Channel port

2 Power LED

4 Port status LED

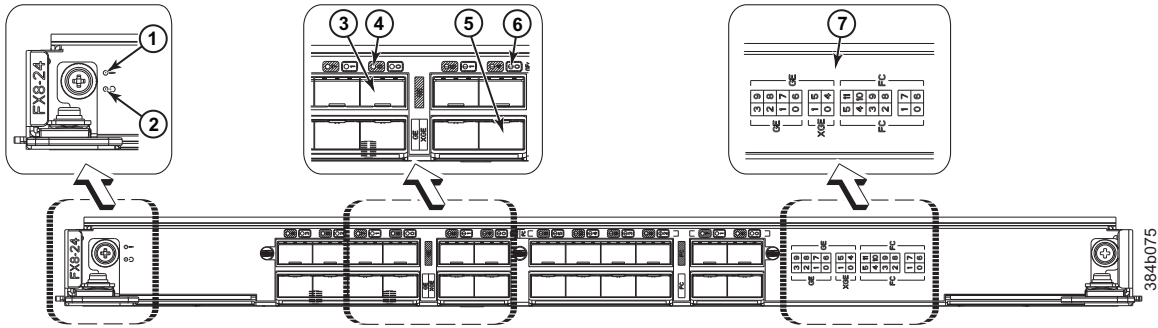

Figure 25. FX8-24 extension blade

- | | | | |
|----------|--------------------------------|----------|----------------------------------|
| 1 | Status LED | 5 | 10GbE (XGE) port 0 |
| 2 | Power LED | 6 | Port status LED for 10GbE port 0 |
| 3 | GbE port 6 | 7 | Port map |
| 4 | Port status LED for GbE port 6 | | |

Table 8 describes the port, application, and encryption blade LED patterns and the recommended actions for those patterns.

Table 8. Port, application, and encryption blade LED descriptions

LED purpose	Color	Status	Recommended Action
Blade power LED	Steady green	Blade is enabled.	No action required.
	No light (LED is off)	Blade is not powered on.	Ensure that the blade is firmly seated and either the thumbscrew is fully engaged or the slider is pushed up and the ejectors are fully engaged.
Blade status LED	No light (LED is off)	Blade is either healthy or does not have power.	Verify that the power LED is on.
	Steady amber	Blade is faulty.	Ensure blade is firmly seated and check the status with the slotShow command. If the LED remains amber, contact IBM.
	Slow-flashing amber (on 2 seconds, then off 2 seconds)	Blade is not seated correctly or is faulty.	Pull blade out and reseal it. If the LED continues to flash, replace the blade.
	Fast-flashing amber (on 1/2 second, then off 1/2 second)	Environmental range exceeded.	Check for out-of-bounds environmental condition and correct it.

Table 8. Port, application, and encryption blade LED descriptions (continued)

LED purpose	Color	Status	Recommended Action	
FC port status	No light (LED is off)	Port has no incoming power, or there is no light or signal carrier detected.	Verify that the power LED is on, check the transceiver and cable.	
		Polling is in progress.	Allow 60 seconds for polling to complete.	
		Connected device is configured in an offline state.	Verify the status of the connected device.	
	Steady green	Port is online (connected to an external device) but has no traffic.	No action required.	
	Slow-flashing green (on 1 second, then off 1 second)	Port is online but segmented, indicating a loopback plug or cable or an incompatible switch.	Verify that the correct device is attached to the SAN384B-2.	
	Fast-flashing green (on 1/4 second, then off 1/4 second)	Port is in internal loopback (diagnostic).	No action required.	
	Flickering green	Port is online, with traffic flowing through port.	No action required.	
	Steady amber	Port is receiving light or signal carrier, but it is not online yet.	Reset the port from the workstation using the portEnable or portCfgPersistentEnable command.	
	Slow-flashing amber (on 2 seconds, then off 2 seconds)	Port is disabled due to diagnostic tests or portDisable or portCfgPersistentEnable command.	Reset the port from the workstation using the portEnable or portCfgPersistentEnable command.	
	Fast-flashing amber (on 1/2 second, then off 1/2 second)	Transceiver or port is faulty.	Change the transceiver or reset the switch from the workstation.	
Alternating green/amber	Port is bypassed	Reset the port from the workstation using the portEnable or portCfgPersistentEnable command.		
GbE port status (FX8-24) - both GbE and 10 GbE ports	No light (LED is off)	Port has no incoming power, or there is no light or signal carrier detected.	Verify that the power LED is on, check the transceiver and cable.	
		Steady green	Port is online but has no traffic.	No action required.
		Slow-flashing green (on 1 second, then off 1 second)	Beacon. Used to identify specific ports.	No action required.
		Flickering green	Port is online, with traffic flowing through port.	No action required.
		Fast-flashing amber (on 1/4 second, then off 1/4 second)	Transceiver or port is faulty.	Change the transceiver or reset the switch from the workstation.

Control processor blade (CP8) status

To determine the status of a CP blade:

1. Check the LED indicators on the CP blade (see Figure 26 on page 60). The LED patterns may temporarily change during POST and other diagnostic tests. For information about how to interpret the LED patterns, see Table 9 on page 60.

2. Check port blade status by entering the `slotShow` and `haShow` commands.

Figure 26 shows the control processor blade (CP8) and component parts.

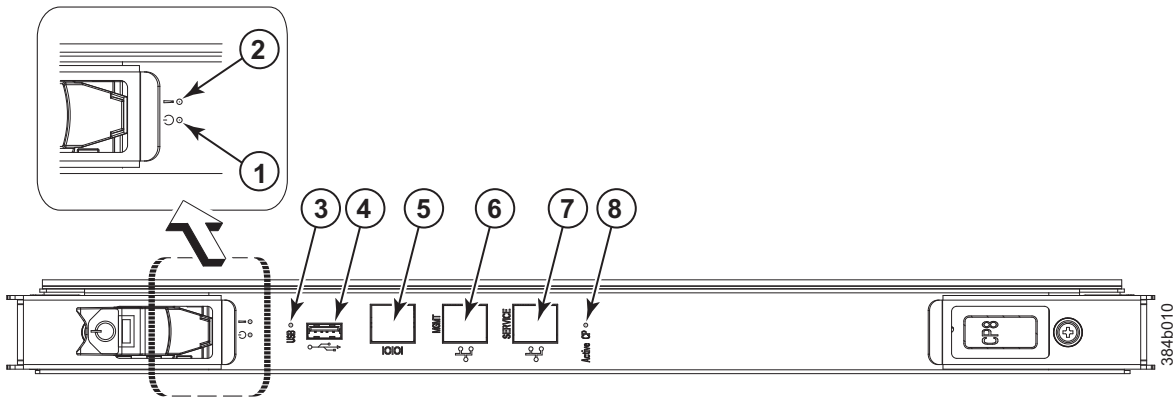

Figure 26. Control processor blade (CP8) ports and LEDs

- | | | | |
|----------|------------------|----------|-----------------------------|
| 1 | Blade power LED | 5 | Console serial port (IOIOI) |
| 2 | Blade status LED | 6 | Ethernet port (MGMT) |
| 3 | USB LED | 7 | Ethernet port (SERVICE) |
| 4 | USB port | 8 | Active CP LED |

Table 9. CP blade LED descriptions

LED purpose	Color	Status	Recommended Action
Power	Steady green	CP blade is on.	No action required.
	No light (LED is off)	CP blade is not on.	Ensure that the blade is firmly seated and has power.
Status	No light (LED is off)	CP blade is either healthy or does not have power.	Verify that the power LED is on.
	Steady amber	CP blade is faulty or the switch is still booting.	Ensure that the blade is firmly seated and the switch has completed booting. If the LED remains amber, contact IBM.
	Slow-flashing amber (on 2 seconds; then off 2 seconds)	CP blade is not seated correctly or is faulty.	Pull the blade out and reseal it. If the LED continues to flash, replace the blade.
	Fast-flashing amber (on 1/2 second; then off 1/2 second)	Environmental range exceeded.	Check for out-of-bounds environmental condition and correct it.

Table 9. CP blade LED descriptions (continued)

LED purpose	Color	Status	Recommended Action
Ethernet link status	No light (LED is off)	Either an Ethernet link is not detected, or it does not have incoming power.	Ensure that the blade has power, the Ethernet cable is firmly seated, and the connected device is functioning.
	Flickering green/amber	Ethernet link is healthy and traffic is flowing through port.	No action required.
Ethernet link speed	No light (LED is off)	Ethernet link speed is 10 Mbps or CP blade does not have incoming power.	Ensure that the CP has power. Note: To force a persistent Ethernet link speed, type the <code>ifModeSet</code> command.
	Steady green	Ethernet link speed is 100/1000 Mbps.	No action required.
USB Status	LED is on	USB device enabled	No action required.
	LED is off	USB device not present or disabled	No action required.
Active CP	Steady blue	Active CP blade.	No action required.
	No light (LED is off)	Standby CP blade.	No action required.

Core switch blade (CR16-4) status

To determine the status of a CR16-4 core switch blade:

1. Check the LED indicators on the core switch blade (Figure 27). The LED patterns may temporarily change during POST and other diagnostic tests; for information about how to interpret the LED patterns, see Table 10 on page 62.
2. Check core switch blade status by entering `slotShow` and `haShow`.

Figure 27 shows the CR16-4 core switch blade and its components.

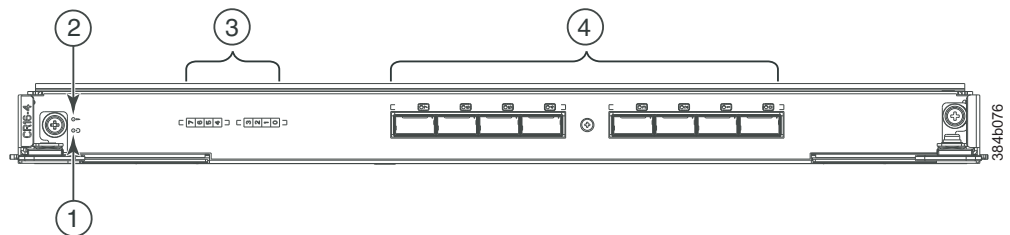

Figure 27. Core switch blade (CR16-4)

- | | | | |
|----------|------------|----------|------------------------------------|
| 1 | Power LED | 3 | QSFP port map and trunking diagram |
| 2 | Status LED | 4 | QSFP connectors |

Table 10. CR16-4 blade LED descriptions

LED purpose	Color	Status	Recommended Action
Power	Steady green	CR16-4 blade is on.	No action required.
	No light (LED is off)	CR16-4 blade is not on.	Ensure blade is firmly seated and has power.
Status	No light (LED is off)	CR16-4 is either healthy or does not have power.	Verify that the power LED is on.
	Steady amber	CR16-4 blade is faulty or the switch is still booting.	Ensure that the blade is firmly seated and the switch has completed booting. If the LED remains amber, contact IBM.
	Slow-flashing amber (on 2 seconds; then off 2 seconds)	CR16-4 blade is not seated correctly or is faulty.	Pull the blade out and reset it. If the LED continues to flash, replace the blade.
	Fast-flashing amber (on 1/2 second; then off 1/2 second)	Environmental range exceeded.	Check for out-of-bounds environmental condition and correct it.
QSFP connector status LED	No light (LED is off)	No QSFP module, all four QSFP ports are disabled	No action needed if the QSFP is not installed or verify that the QSFP is fully inserted.
	Steady amber	QSFP module is in, all four ports have no signal/no sync.	Ensure that the cable is properly connected. If the LED remains amber, contact IBM.
	Blinking amber	Port is disabled or faulted, FC link activity, segmented, loopback mode, also during transition between cable plug in and all four ports online.	Check for console messages or wait for all four ports to come online.
	Steady green	QSFP module is in and all ports are online.	No action needed.

Refer to Figure 52 on page 141 for an illustration of the physical ports on the CR16-4 core blade and Table 28 on page 141 for a table mapping the external ports to internal ports as shown in the **slotShow** command

Power supply status

To determine the status of a power supply:

1. Check the LED indicators on each power supply (see Figure 28). The LED patterns may temporarily change during POST and other diagnostic tests; for information about how to interpret the LED patterns, see Table 11. Be sure to check both power supplies.
2. Check the power supply status by entering **psShow**.

The power supply status displays **OK**, **Absent**, or **Faulty**. If a power supply displays absent or faulty, contact IBM to order a replacement. Both "absent" or "faulty" could also be the result of the power supply being turned off or not being properly seated.

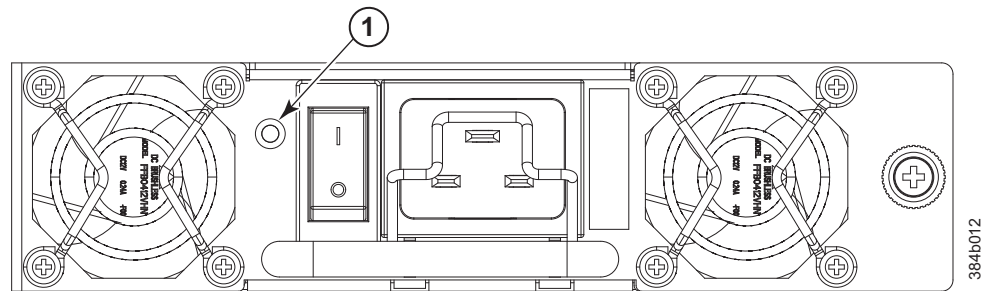

Figure 28. Power supply

1 Power LED

Table 11. Power supply LED descriptions

LED purpose	Color	Status	Recommended Action
Power	No light (LED is off)	Power supply does not have incoming power and is not providing power to the SAN384B-2.	Ensure that the power supply is firmly seated, the SAN384B-2 has incoming power, both power cables are connected, and AC power switches are on.
	Steady green	Power supply has incoming power and is providing power to the SAN384B-2.	No action required.
	Flashing green	Power supply is about to fail.	Replace the power supply.

Blower assembly status

To determine the status of a blower assembly:

1. Check the LED indicators on each blower assembly (see Figure 29 on page 64). The LED patterns may temporarily change during POST and other diagnostic tests; for information about how to interpret the LED patterns, see Table 12 on page 64. Be sure to check both blower assemblies.

2. Check the blower assembly status using the **fanShow** command.

The status for each blower assembly displays **OK**, **Absent**, or **Faulty**. The RPM of each fan in the assembly is also provided. If a blower assembly displays *absent* or *faulty*, contact IBM to order a replacement. Both "absent" or "faulty" could also be the result of the blower assembly not being properly seated.

Figure 29 shows the blower assembly.

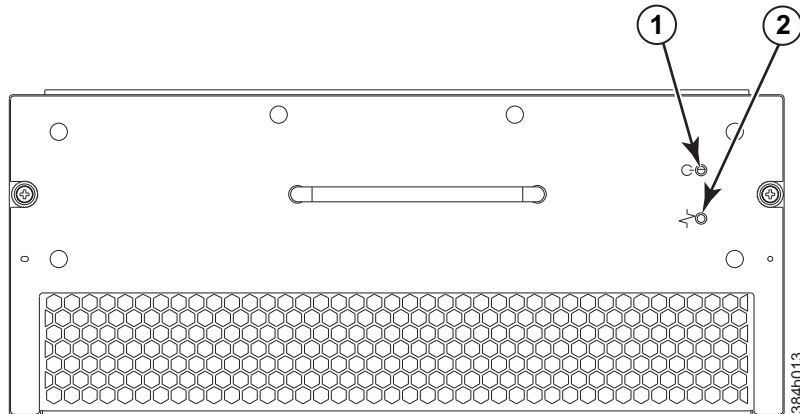

Figure 29. Blower assembly LEDs

- 1** Power LED
- 2** Fault LED

Table 12. Blower assembly LED descriptions

LED purpose	Color	Status	Recommended action
Power	No Light (LED is off)	Blower assembly does not have power.	Ensure that the blower assembly is firmly seated and has power.
	Steady green	Blower assembly has power.	No action required.

Table 12. Blower assembly LED descriptions (continued)

LED purpose	Color	Status	Recommended action
Fault	No Light (LED is off)	Blower assembly is either healthy or does not have power.	Ensure that the blower assembly has power.
	Steady amber	Blower assembly has a failure (full or partial).	Replace the blower assembly.
	Slow-flashing amber (on 2 sec, then off 2 sec)	Blower assembly is not seated correctly or is faulty.	Pull the unit out and reseal it. If the LED continues to flash, replace the unit.
	Flashing amber (on 1/2 sec, then off 3.5 sec)	Fan is disabled.	Run fanEnable to enable the fan.
	Fast-flashing amber (on 1/2 sec, then off 1/2 sec)	Environmental range exceeded.	Check for out-of-bounds environmental condition, resolve any problems, and reseal the unit. If the LED continues to flash, replace the unit.

WWN card status

Note: The WWN bezel (see Figure 30 on page 66) covers the WWN cards. The LEDs on the WWN cards are not visible unless the bezel is removed.

To determine the status of the WWN card, enter the **chassisShow** command to display information about the WWN card. (WWN units correspond to information specific to the WWN card.) Error messages that may indicate problems with a WWN card are summarized in Table 13.

Table 13. Messages that may indicate WWN card failure

Type of Message	Sample error message
WWN unit fails its FRU (field replaceable unit) header access.	0x24c (fabos): Switch: switchname, error EM-I2C_TIMEOUT, 2, WWN 1 I2C timed out: state 0x4
WWN unit fails to power on	<timestamp>, [EM-1004], <sequence-number>,,CRITICAL, <system-name>, WWN # failed to power on or <timestamp>, [EM-1043], <sequence-number>,, WARNING, <system-name>, Can't power <FRU Id> <state (on or off)>

Table 13. Messages that may indicate WWN card failure (continued)

Type of Message	Sample error message
WWN unit is being faulted.	0x24c (fabos): Switch: switchname, Critical EM-WWN_UNKNOWN, 1, Unknown WWN #2 is being faulted or <timestamp>, [EM-1003], 40, SLOT 7 FFDC CHASSIS, CRITICAL, SAN384B-2, WWN 2 has unknown hardware identifier: FRU faulted or <timestamp>, [EM-1034], <sequence-number>, ERROR, <system-name>, WWN # set to faulty, rc=<return code>
WWN unit is not present or is not accessible.	0x24c (fabos): Switch: switchname, Error EM-WWN_ABSENT, 2, WWN #1 not present or <timestamp>, [EM-1036], <sequence-number>, WARNING, <system-name>, <FRU Id> is not accessible.
Writing to the FRU history log (hilSetFruHistory) has failed.	0x24c (fabos): Switch: switchname, Error EM-HIL_FAIL, 2, HIL Error: hilSetFruHistory failed, rc=-3 for SLOT 3
WWN unit insertion was detected	<timestamp> [EM-1049], <sequence-number>, INFO, <system-name>, FRU WWN # insertion detected.
WWN unit removal was detected	<timestamp> [EM-1050], <sequence-number>, INFO, <system-name>, FRU WWN # removal detected.

Figure 30 displays the WWN bezel. The WWN bezel must be removed to reveal the WWN cards and LEDs. See “Removing and installing a WWN bezel and WWN card” on page 88 for removal instructions.

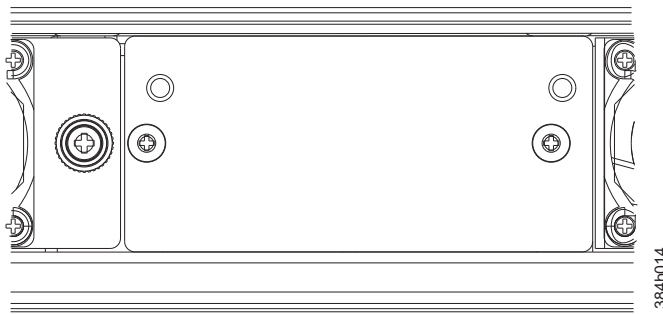

Figure 30. WWN bezel

Chapter 5. Removing and installing components

Attention: Read the safety notices before servicing (see “Safety notices and labels” on page xv).

The field replaceable units (FRUs) in the SAN384B-2 can be removed and installed without special tools. The SAN384B-2 can continue operating during many of the FRU replacements if the conditions specified in the procedures are followed.

Attention: The system contains electrostatic discharge (ESD) sensitive FRUs. When working with any FRU, follow ESD precautions (see “ESD precautions” on page xxi).

The following sections contain FRU removal and installation procedures.

- “Removing and installing the chassis door”
- “Removing and installing cable management finger assemblies” on page 68
- “Removing and installing port, application, and encryption blades” on page 70
- “Removing and installing blade filler panels” on page 72
- “Removing and installing a CP8 control processor blade” on page 73
- “Removing and installing a CR16-4 core switch blade” on page 82
- “Removing and installing a power supply” on page 84
- “Removing and installing a blower assembly” on page 86
- “Removing and installing a WWN bezel and WWN card” on page 88
- “Removing and installing transceivers” on page 89
- “Removing and replacing inter-chassis link (QSFP) cables” on page 93
- “Removing and replacing a SAN384B-2 chassis” on page 98

Removing and installing the chassis door

Note: The chassis door must be installed to ensure the SAN384B-2 meets EMI and other regulatory certifications. Additionally, if ICL cables are not used, EMI plugs must be inserted in the ICL cable ports to meet certification standards.

Time and items required

The replacement procedure for the chassis door takes less than 5 minutes.

Removing the chassis door

Complete the following steps to remove a chassis door.

1. Support the door to prevent it from falling.
2. Pull and remove the door. It will pop off the ball studs.

Complete the following steps to install a chassis door.

1. Align the holes on the back of the door with the ball studs on the chassis
2. Push the door into place. It will snap onto the studs. See Figure 31 on page 68.

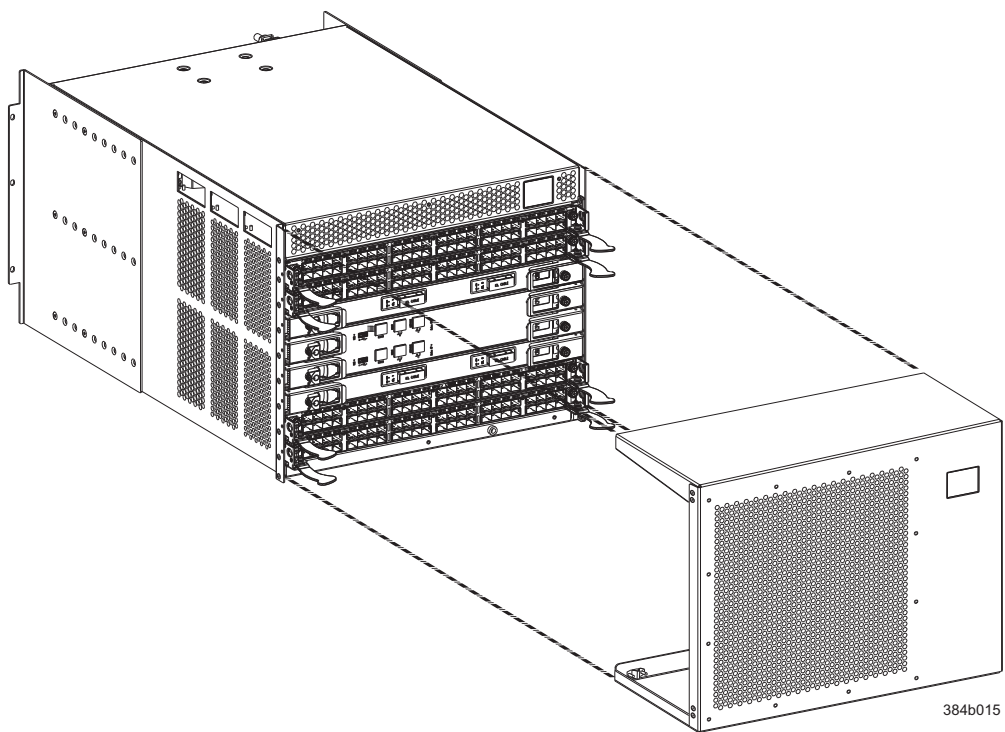

Figure 31. Chassis door

Removing and installing cable management finger assemblies

The SAN384B-2 comes equipped with two vertical cable management finger assemblies. It can continue to operate during the replacement of the cable management assemblies. Due to the horizontal orientation of the blades, the cable management assemblies are attached to the uprights of the mounting rack.

Time and items required

The replacement procedure for the cable management fingers takes less than five minutes. A #1 Phillips screwdriver is required.

Removing a cable management finger assembly

Complete the following steps to remove the cable management finger assembly.

1. Remove the chassis door.
2. Remove the cables from the cable management finger assembly and rearrange the cables around the assembly.
3. Unscrew and save the two screws that attach the cable management assembly to the rack upright (see Figure 32 on page 69). Support the assembly to prevent it from falling.
4. Remove the cable management assembly.
5. If necessary, repeat steps 2-4 for the other cable management assembly.

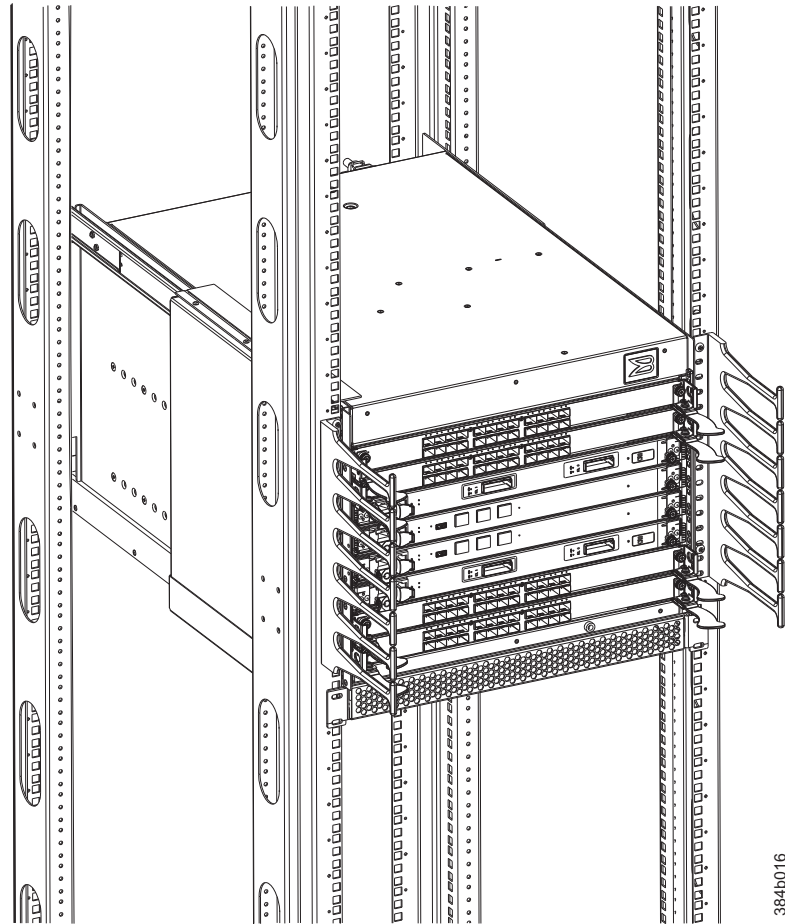

Figure 32. Cable management finger assemblies

Installing a cable management finger assembly

Complete the following steps to install a cable management finger assembly.

1. Position the vertical cable management finger assembly along the upright rails of the rack, aligning the holes on the assembly with the holes in the SAN384B-2 chassis.
2. Insert and tighten the two screws to secure the cable management assembly to the rack's vertical rails.

Note: Three screws secure the chassis to the cabinet vertical rails, two of which are also used to secure the cable management assembly. The holes on the assembly will only match two of the holes on the chassis at a time. This will allow the cable management assemblies to be mounted either towards the top or towards the bottom of the chassis, depending on cable density and desired cable routing.

3. Arrange the cables through the fingers of the cable management assembly.
4. Repeat steps 1-3 for the other cable management assembly.
5. Replace the chassis door.

Removing and installing port, application, and encryption blades

This section describes how to remove and install port, application, and encryption blades.

Attention: A blade should be removed only when being replaced with another blade or a filler panel. Any slot that is not occupied by a blade should be occupied by a filler panel to ensure correct cooling of the chassis and protection from dust.

Slots are numbered from 1 through 8, from bottom to top when facing the port side of the SAN384B-2. Port, application, and encryption blades can be installed in slots 1–2 and 7–8.

Attention: Follow ESD precautions (see “ESD precautions” on page xxi) for removal or replacement of any blades.

Time and items required

The replacement procedure for each blade takes 5 to 25 minutes, depending on the number of ports, transceivers, and cables involved. The following items are required for the blade and filler panel replacement:

- ESD (electrostatic discharge) grounding strap
- Workstation computer
- Replacement blade or filler panel
- #2 Phillips screwdriver
- Small form-factor pluggable SFP+, or mSFP transceivers (as needed)
- Optical and copper cables (as needed)

Removing a port or application blade

Attention: If multiple blades are being replaced, replace one blade at a time.

Attention: Follow ESD precautions (see “ESD precautions” on page xxi) for removal or replacement of any blade.

Note: The FC8-64 port blade, the FS8-18 encryption blade, and the FX8-24 application blade are compatible with the SAN384B, SAN384B-2, SAN768B, and SAN768B-2. The FC8-32E, FC8-48E, FC16-32, and FC16-48 port blades are compatible only with the SAN384B-2 and SAN768B-2.

Complete the following steps to remove a port blade.

1. Remove the chassis door. (See “Removing and installing the chassis door” on page 67.)
2. Check the power LED, status LED, and port status LEDs to identify any possible problems. A failed port or application blade can be identified by inspecting the LEDs on the front panel of each blade. See Figure 19 on page 55 to Figure 25 on page 58 for LED locations.
3. Establish a Telnet or console session.
Before installing a blade, establish a Telnet or console connection to determine a failure and verify operation after installation. Use the **slotShow** command to view the status of blades.
4. Check for adequate cable slack. Ensure there is plenty of cable slack to remove a blade without cable obstruction.

5. Ensure that the part number on the unit being installed matches the replacement part number (unless you are performing an upgrade). The **chassisShow** command displays information about the blades, including part numbers, serial numbers, and additional status.
6. Ensure that traffic is not flowing through the blade (port status LED should be off) prior to disconnecting cables.

Note: Before removing any cables from a blade, note the cable order (identify each cable by its physical port). If multiple blades are being installed, install one blade at a time. Labeling the cables before removal is recommended. It is a good practice to keep a table of cable to port mapping.

7. Disconnect all cables and transceivers from the blade. For mSFP transceivers (FC8-64 only), it is recommended that you use the pull tab to remove the transceiver from the blade before removing the cable from the transceiver.
8. Unscrew the two thumbscrews from the left and right ejectors on the blade using the Phillips screwdriver. Unscrew the left thumbscrew until it pops out. This initiates a hot-swap request.
9. Wait for the power LED to turn off in response to the hot-swap request before removing the blade.
10. Open the ejectors by pulling them toward the center of the blade face. Pull the blade out of the chassis using the ejectors (Figure 33).

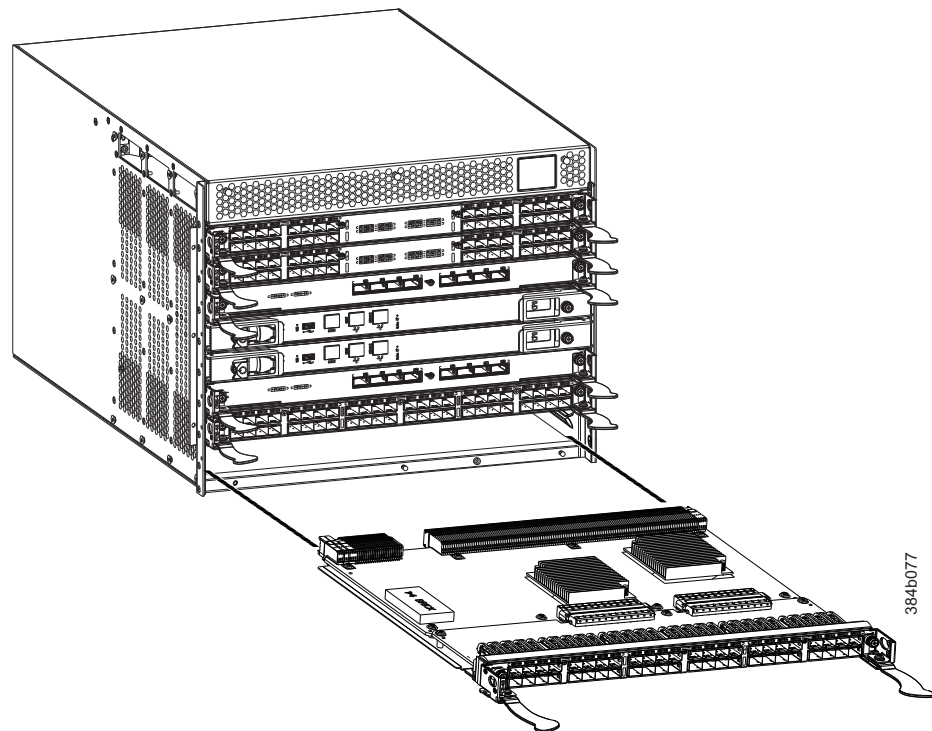

Figure 33. Port, application, and encryption blade removal and installation (FC16-48 port blade shown)

11. If the blade is not being replaced by another blade, install a filler panel. See “Installing a filler panel” on page 73.

Installing a blade

Complete the following steps to install a port, application, or encryption blade.

Attention: Follow ESD precautions (see “ESD precautions” on page xxi).

1. Orient the blade so that the ports are at the front of the chassis and the flat side of the blade is on the bottom.
2. Open the ejectors by rotating them toward the center of the blade face, align the flat side of the blade inside the left and right rail guides in the slot, and slide the blade into the slot until it is firmly seated.
3. Close the ejectors by rotating them away from the center of the blade. The levering action of the ejectors seats the blade in the slot.
4. Tighten the left and right thumb screws using the Phillips screwdriver.
5. Verify that the power LED on the blade displays a steady green light (it might require a few seconds to turn on). If it does not turn on, ensure that the blade is firmly seated.
6. The Status LED on the blade will show amber until POST completes for the blade. It should then display green. If it remains amber, the blade may not be properly seated in the backplane or the blade may be faulty.
7. Install the SFP+ transceivers and cables in the port blade. For mSFP (FC8-64 only) transceivers, it is recommended that you install the cables into the transceivers before installing the transceivers in the blade.
8. Group and route the cables through the vertical cable management fingers.
9. Install the chassis door.

Note: The FS8-18 encryption blade requires additional configuration to enable encryption. See “Configuring for encryption (optional)” on page 46.

Removing and installing blade filler panels

This section describes how to remove and install port blade filler panels.

Note: Some filler panels have two thumbscrews and some have only one. Be sure to unscrew or tighten both if you are using the two-screw version.

Removing a filler panel

Attention: A filler panel should be removed only when being replaced with a port, application, or encryption blade or new filler panel. Any slot that is not occupied by a blade should be occupied by a filler panel to ensure correct cooling of the chassis and protection from dust.

Complete the following steps to remove a filler panel.

1. Remove the chassis door (“Removing and installing the chassis door” on page 67).
2. Unscrew the thumbscrews(s) on the panel using the Phillips screwdriver.
3. Using the handles, pull the filler panel out of the chassis (Figure 34 on page 73).

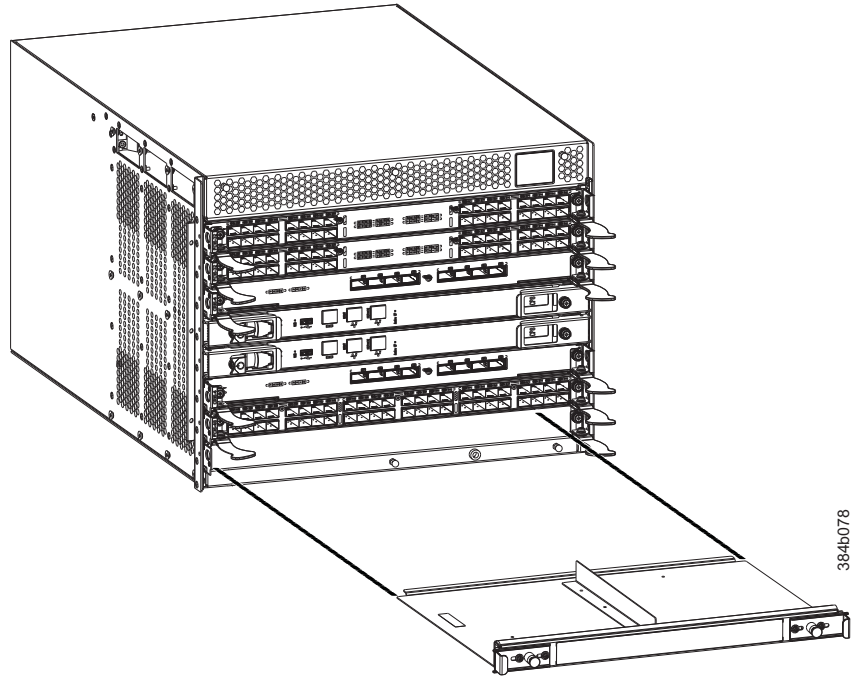

Figure 34. Filler panel removal and installation

Installing a filler panel

Attention: Do not leave a slot empty. This will adversely affect cooling of the chassis.

Complete the following steps to install a filler panel.

1. Orient the filler panel in front of the empty slot (see Figure 34).
2. Slide the filler panel into the slot until it is firmly seated.
3. Tighten the thumbscrew(s).
4. Install the chassis door (see “Removing and installing the chassis door” on page 67).

Removing and installing a CP8 control processor blade

This section describes how to remove and install a control processor (CP8) blade. Each SAN384B-2 has two CP8 blades, located in slot 4 and slot 5.

Note: Chassis slots are numbered from 1-8 from bottom to top, viewed from the port side of the chassis.

Attention: If the new CP blade does not have the same firmware as the active CP blade, the new blade must be upgraded to the same firmware version. You can determine the firmware version on the replacement blade and do a firmware upgrade if necessary after inserting the blade in the chassis, but you **MUST** disable high availability (HA) before inserting the new blade. If the new CP blade is severely down-level, a very specific and detailed procedure must be followed to bring the blade up to the correct firmware version. Refer to the *Fabric OS Administrator's Guide* for information. Also see "Downloading firmware from an FTP server" on page 78, "Downloading firmware from a USB device" on page 80, and "Fabric OS firmware updates" on page 48.

Time and items required

The installation procedure for the CP blade takes approximately 30 minutes. The following items are required for the CP blade installation:

- ESD (electrostatic discharge) grounding strap
- Workstation computer
- Serial cable
- IP address of an FTP server for backing up the SAN384B-2 configuration
- #2 Phillips screwdriver
- Replacement CP blade. The SAN384B-2 requires the CP8 blade.

Attention: If you are upgrading through multiple versions of the Fabric OS, refer to Table 14 on page 78, to see if you will need any intermediate versions of the Fabric OS. Plan carefully and provide for extra time if this is your situation.

Verifying the need for replacement

Confirm that you need to replace the CP blade. The following events might indicate that a CP blade is faulty:

- The status LED on the CP blade displays steady amber, or the power LED is not lit.
- The CP blade does not respond to Telnet commands, or the serial console is not available.
- The **slotShow** command does not show that the CP blade is enabled.
- The **haShow** command indicates an error.
- The clock is inaccurate, or the CP blade does not boot up or shut down normally.
- Any of the following messages display in the error log:
 - "Slot unknown" message relating to a CP slot
 - CP blade errors or I²C timeouts
 - FRU: FRU_FAULTY messages for a CP blade
 - Configuration loader messages or "Sys PCI config" messages
 - Generic system driver messages ("FABSYS")
 - Platform system driver messages ("Platform")
 - EM messages that indicate a problem with a CP blade
 - Function fail messages for the CP master

For more information about error messages, refer to the *Fabric OS Message Reference*.

Recording critical SAN384B-2 information

Back up the SAN384B-2 configuration before you replace a CP blade. Refer to the *Fabric OS Administrator's Guide* for backup information.

1. Connect to the chassis and log in as **admin**, using a serial console connection.
2. Enter **haShow** to determine which CP blade is active:

```
SAN384B-2:admin> hashow
Local CP (Slot 5, CP1) : Active
Remote CP (Slot 4, CP0) : Standby, Healthy
HA Enabled, Heartbeat Up, HA State Synchronized
```

3. Enter all remaining commands from the serial console for the active CP blade, unless otherwise indicated. For more information about commands, refer to the *Fabric OS Command Reference*.
4. If the active CP blade is faulted, automatic failover to the standby CP blade should have occurred. Confirm that the standby CP blade is active and power off the faulted CP blade, log in to standby CP blade, and skip to step 7. If automatic failover has not occurred, manually failover the faulty blade by moving the slider to the off position (to the right). Then power off the faulted blade, log in to standby CP blade, and skip to step 7.
5. If both CP blades are healthy and you want to replace the standby CP blade, log in to the active CP blade and skip to step 7.
6. If both CP blades are healthy and you want to replace the active CP blade, log in to the active CP blade and run the following steps:
 - a. Run the **haFailover** command to make the standby CP blade the active blade. The currently active CP blade becomes the standby blade. Wait until the status LED on the currently active CP blade is no longer lit.
 - b. Confirm the completion of the failover by running the **haShow** command.
 - c. Log in to the new active CP blade.
7. Run the **firmwareShow** command to note the firmware version of the active CP blade.

The example below shows the results of the **firmwareShow** command when the firmware versions on the two CP blades are not the same. Note the warning message at the end of the output.

```
SAN384B-2_120:root> firmwareshow
Slot Name  Appl  Primary/Secondary Versions  Status
-----
4 CP0      FOS   v7.0.0                        STANDBY
           v7.0.0
5 CP1      FOS   v7.0.0a                       ACTIVE *
           v7.0.0a
WARNING: The local CP and remote CP have different versions
of firmware, please retry firmwaredownload command.
SAN384B-2:root>
```

8. Run **haDisable** from the active CP blade to prevent failover or communication between the CP blades during the replacement.
9. Use the **configUpload** command to upload the chassis configuration to a specified FTP server. Enter information at the prompts.
 - a. Run the **fosConfig --show** command to determine if virtual fabrics are enabled. If so, run the **configupload -vf** command. This command uploads the SAN384B-2 virtual fabric data.
 - b. If virtual fabrics are not enabled, run the **configUpload** command. This command uploads the SAN384B-2 configuration.

Removing a control processor blade (CP8)

The SAN384B-2 continues to operate while a CP blade is being installed if the redundant CP blade is active and a failover does not occur. You can prevent failover by entering the **haDisable** command.

Attention: Follow ESD precautions (see “ESD precautions” on page xxi) when handling any blades.

Complete the following steps to remove a CP8 control blade (CP).

1. Remove the chassis door. (See “Removing and installing the chassis door” on page 67.)
2. Log in to the active CP as the **admin**. You can use a serial cable or Telnet, Web Tools, or Fabric Manager. Determine which CP is active using the **haShow** command or view the active LED on the front of the CP.
3. If the faulty CP is the active CP, issue the **haFailover** command. Wait until the failover has completed. Use the **haShow** command to verify the CPs are synchronized and the failover is complete.
Depending on the nature of the CP failure, it is possible that the **haFailover** command will not work. Proceed to the next step anyway.
4. Enter the **haDisable** command. This is required before physically removing and replacing the CP blades.
5. Power off the blade you are replacing by sliding the slider switch in the left ejector to the right, to the off position.
Do not eject the blade until the power LED is off and you have completed the next two steps.
6. Disconnect all cables from the faulty (standby) CP blade you are replacing.
7. Unscrew the thumb screws from both ejectors using the Phillips screwdriver.
8. Lever open both ejector handles simultaneously to approximately 45 degrees and pull the CP blade out of the chassis (see Figure 35 on page 77).

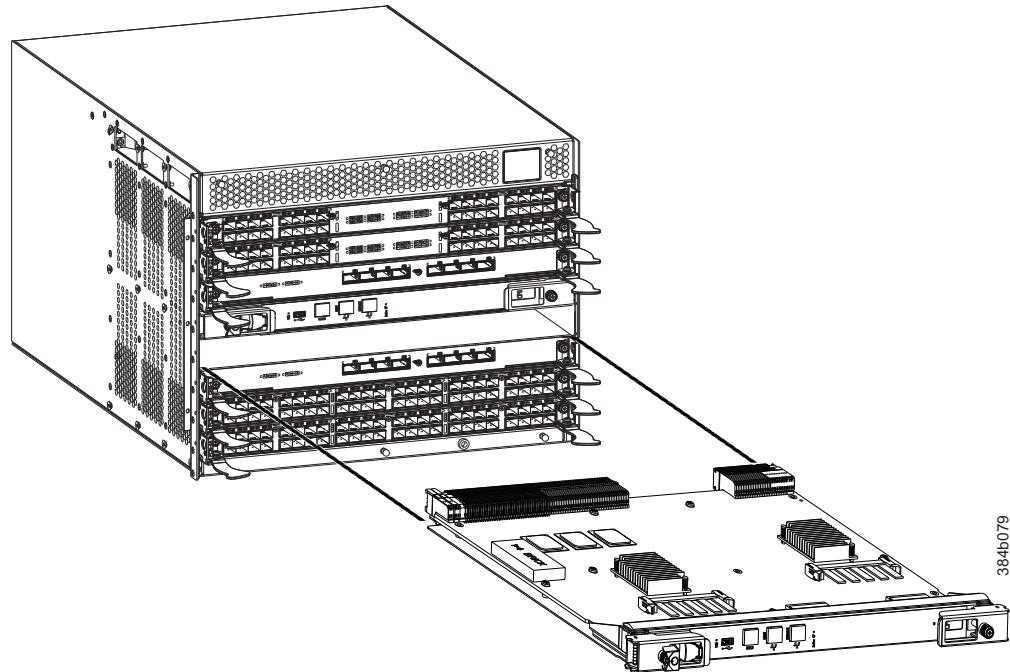

Figure 35. Removing the control processor (CP8) blade

Installing a control processor blade (CP8)

Attention: Read all instructions for installing the CP blade before beginning the procedure. Use the same version of Fabric OS on both CP blades. Using different versions is not supported and may cause malfunctioning. If the replacement CP blade has a different version of Fabric OS, bring both blades to the same firmware version. Once you have installed the replacement CP blade, see “Verifying operation of the new CP blade” on page 78 for information about determining the version of firmware on the replacement CP blade and upgrading it if necessary.

Attention: Follow ESD precautions (see “ESD precautions” on page xxi) whenever handling a blade.

Complete the following steps to install a CP blade (slot 4 or 5).

1. Open the ejector handles to approximately 45 degrees. Orient the CP blade so that the handles are toward you and the flat metal side is on the bottom.
2. Align the flat metal side of the CP blade inside the left and right blade guides in the slot. Slide the CP blade into the slot until it is firmly seated.
3. Tighten the thumb screw inside each handle using the Phillips screwdriver.
4. Turn the CP blade on by sliding the ON/OFF switch in the left handle to the left, to cover the thumb screw.
5. Verify that the power LED is green. If not, ensure that the CP blade has power and is firmly seated and that the ejectors are in the locked position.
6. Connect the cables to the new CP blade.
7. Remain logged in to the active CP and continue to “Verifying operation of the new CP blade” on page 78.

Verifying operation of the new CP blade

To verify that boot and POST are complete on the new CP blade and that the CP blade has achieved failover redundancy, complete the following steps.

1. Enter **slotShow**. The command output shows the new CP blade as “enabled.” If the standby CP is unresponsive, try unplugging the new CP blade, running **haDisable** on the active CP blade, and plugging the new CP blade back in. At that point, you can repeat step 1 to begin the verification process again.
2. Determine the Fabric OS version by entering **firmwareShow**. If the serial console on the replacement CP blade is connected, issue the **firmwareShow** command there. More information is available through the console.

Attention: The SAN384B-2 requires Fabric OS 7.0.0 or later, to be recognized. The FC8-32E and FC8-48E blades require FOS 7.0.1 or later. If the firmware on the replacement blade is earlier than 7.0.0, it must be brought up to the version (7.0.0 or later) on the active CP blade, which must be at least 7.0.0. IBM recommends upgrading to the latest version available.

3. If the firmware versions for both CP blades are the same, skip to “Completing the CP8 blade replacement” on page 81. If the firmware version on the replacement blade does not match that on the active CP blade, a warning message appears with the results of the **firmwareShow** command. The results of the **firmwareShow** command may look similar to the following. Note the warning message at the end of the output.

```
SAN384B-2_120:admin> firmwareshow
Slot Name  Appl  Primary/Secondary Versions  Status
-----
4 CP0      FOS    v7.0.0a                      ACTIVE
           v7.0.0a
5 CP1      FOS    v7.0.0                        STANDBY *
           v7.0.0
```

WARNING: The local CP and remote CP have different versions of firmware, please retry firmwaredownload command.

4. You must bring the replacement blade to the same firmware level as the active blade by using the **firmwareDownload -s** command *directly on the replacement blade* to bring it up to the proper level. The **firmwareshow** command results show which slots hold the active and standby (replacement) CP blades. If you are using an FTP server to download the firmware, skip to “Downloading firmware from an FTP server.” If you are using a USB device to download the firmware, skip to “Downloading firmware from a USB device” on page 80. If the firmware on the standby CP blade is more than one level down from the level on the active CP blade, you must have formatted USB devices for each of the versions you will need to upgrade.

Table 14. Steps for upgrading through multiple versions of Fabric OS

If your current Fabric OS version is...	and your target FOS version is...	complete these upgrade steps
7.0.0x	7.0.1	use firmwareDownload -s to upgrade directly to 7.0.1

Downloading firmware from an FTP server

For this task, refer to Table 14 for the correct sequence of upgrading firmware versions to reach your target version. Complete the following steps to download the firmware from an FTP server.

1. Log in to the standby CP blade as **admin**. If you need to know the IP address of the standby blade, run **ipaddrshow**.
You should also remain logged in to the active CP blade in order to monitor it.
2. Run **firmwareDownload -s** to download the firmware to the standby CP blade. The **-s** option also disables the autoreboot, so you will have to manually issue a reboot after the download finishes to initiate **firmwarecommit**. Enter all requested information (use default values).
3. To download firmware through the IBM site,
 - a. Go to the IBM Support Portal, www.ibm.com/supportportal
 - b. Search for your product machine type (2499) or product name
 - c. On the displayed page click **Download** in the **Task** section
 - d. From the displayed page, select the appropriate release notes link and read the release notes prior to downloading and installing the firmware update
 - e. From the **Release notes** page, click the **Release Firmware** link and follow the online prompts to navigate to the **Brocade Downloads for IBM End Users** page.
 - f. Follow the instructions on the Brocade pages. Enter all requested information (use default values).
4. When the download process finishes, run **firmwareDownloadStatus** to verify that the firmware has been updated. The command displays a running account of the progress of the **firmwareDownload** command (if it is still running) until the command has completed. The final message is similar to the following and will appear with a date and time stamp:
Slot 4 (CP0, active): Firmwaredownload command has completed successfully.
Use **firmwareshow** to verify the firmware versions.
5. On the standby CP blade (the blade for which you just changed the firmware level), run **reboot**. The reboot of the standby CP will initiate a **firmwarecommit** to the secondary partition and log you out.

```

SAN384B-2_124:admin> reboot
Broadcast message from root (ttyS0) Fri Jun 18 14:49:45 2011...
The system is going down for reboot NOW !!
INIT: Switching to runlevel: 6
INIT: Sending processes the TERM signal SAN384B-2_124:admin> HAMu
Heartbeat down, stop FSS
Unmounting all f##exiting due to signal: 9, pending signals:
0x20000, 0x0 filesystems.
Please stand by while rebooting the system...
Restarting system.
The system is coming up, please wait...
.
.
.
Fri Jun 18 14:53:13 2011: Doing firmwarecommit now.
Please wait ...
Fri Jun 18 14:55:27 2011: Firmware commit completes successfully.
Validating the filesystem ...
Fri Jun 18 22:36:05 2011: Doing firmwarecommit now.
Please wait ...
Fri Jun 18 22:36:48 2011: Firmware commit completes successfully.
2011/06/18-14:56:50, [SULB-1004], 908, SLOT 4 | CHASSIS, INFO,
SAN384B-2, Firmwarecommit has completed.
2011/06/18-14:56:50, [SULB-1036], 909, SLOT 4 | CHASSIS, INFO,
SAN384B-2,The new Version: Fabric OS v7.0.1
2011/06/18-14:56:50, [SULB-1002], 910, SLOT 4 | CHASSIS, INFO,
SAN384B-2, Firmwaredownload command has completed successfully.

```

Note: The time stamp on the co-cpu may not be in sync with the main cpu on the blade. This is not a cause for concern.

6. Log back in to the standby CP blade and run **firmwareDownloadStatus** on the standby CP blade to validate a successful commit. This may take up to 10 minutes.
7. If you are upgrading through several levels of the Fabric OS, repeat step 2 through step 7 as often as necessary based on the path outlined in the table above. Otherwise, proceed to step 9.
8. Log out of the standby CP blade and log in to the active CP blade.
9. Proceed to “Completing the CP8 blade replacement” on page 81

Downloading firmware from a USB device

For this task, refer to Table 14 on page 78 for the correct sequence of upgrading firmware versions to reach your target version.

Complete the following steps to download the firmware from a USB device.

This section assumes that the new firmware has already been copied onto the USB device. The folder structure on the USB device must be as follows in order to allow the device to be enabled:

```
brocade>
config
firmware
firmwareKey
support
```

The firmware folder contains the folder for the specific release you are installing.

1. Insert the USB drive into the USB port of the active CP blade.
2. Attach a serial cable from the PC to the active CP blade.
3. Log in to the active CP blade as **admin** if you are not still logged in and then enter **usbStorage -e** to enable the USB device.
4. Remove the serial cable from the active CP blade and attach it to the standby CP blade and log in as **admin**.
5. Run **firmwareDownload -s** to download the firmware to the standby CP blade.

The **-s** option also disables the autoreboot, so you will have to manually issue a reboot after the download finishes to initiate **firmwarecommit**. Enter all requested information (use default values).

6. When the download process finishes, run **firmwareDownloadStatus** to verify that the firmware has been updated. The command displays a running account of the progress of the **firmwareDownload** command until the command has completed. The final message is similar to the following and will appear with a date and time stamp:

```
Slot 4 (CP0, active): Firmwaredownload command has completed
successfully. Use firmwareshow to verify the firmware versions.
```

7. Ensure that you are still logged in to the standby CP blade (the blade for which you just changed the firmware level) and type **reboot**. The reboot of the standby CP will initiate a **firmwarecommit** to the secondary partition and log you out.

```
SAN384B-2_124:admin> reboot
Broadcast message from root (ttyS0) Fri Jun 18 14:49:45 2011...
The system is going down for reboot NOW !!
INIT: Switching to runlevel: 6
INIT: Sending processes the TERM signal SAN384B-2_124:admin> HAMu
Heartbeat down, stop FSS
Unmounting all f##exiting due to signal: 9, pending signals:
0x20000, 0x0 filesystems.
Please stand by while rebooting the system...
```



```

Restarting system.
The system is coming up, please wait...
.
.
.
Fri Jun 18 14:53:13 2011: Doing firmwarecommit now.
Please wait ...
Fri Jun 18 14:55:27 2011: Firmware commit completes successfully.
Validating the filesystem ...
Fri Jun 18 22:36:05 2011: Doing firmwarecommit now.
Please wait ...
Fri Jun 18 22:36:48 2011: Firmware commit completes successfully.
2011/06/18-14:56:50, [SULB-1004], 908, SLOT 4 | CHASSIS, INFO,
SAN384B-2, Firmwarecommit has completed.
2011/06/18-14:56:50, [SULB-1036], 909, SLOT 4 | CHASSIS, INFO,
SAN384B-2, The new Version: Fabric OS v7.0.1
2011/06/18-14:56:50, [SULB-1002], 910, SLOT 4 | CHASSIS, INFO,
SAN384B-2, Firmwaredownload command has completed successfully.

```

Note: The time stamp on the co-cpu may not be in sync with the main cpu on the blade. This is not a cause for concern.

8. Log back in to the standby CP blade and enter **firmwareDownloadStatus** on the standby CP blade to validate a successful commit. This may take up to 10 minutes.
9. If you are upgrading through several levels of the Fabric OS, repeat step 4 through step 8 as often as necessary based on the path outlined in the table above. Otherwise, proceed to step 10
10. Log out of the standby CP blade and log in to the active CP blade.
11. Proceed to “Completing the CP8 blade replacement.”

Completing the CP8 blade replacement

Complete the following steps to complete the CP8 control blade replacement procedure.

1. Enter **haEnable** to re-enable HA on the active CP blade

Note: **haEnable** will cause the standby CP blade to reboot. Wait until the power cycles and the POST completes before moving to the next step. POST is complete when the Status LED on the CP blade returns to a steady green state.

2. Enter **haShow** and verify that the command output includes “*HA Enabled, Heartbeat Up*”. If it is not yet enabled, re-enter the command until you have verified that redundancy is achieved.

```

DCX_124:admin> hashow
Local CP (Slot 5, CP1) : Active
Remote CP (Slot 4, CP0) : Standby, Healthy
HA Enabled, Heartbeat Up, HA State Synchronized

```

3. Enter **firmwareShow** to verify that the firmware version has been updated and that the versions are the same on the two CP blades. Not all slot numbers are shown in this example.

```

384B_2:admin> firmwreshow
Slot Name    Appl  Primary/Secondary Versions    Status
-----
2 FX8-24     FOS   v7.0.1
              v7.0.1
4 CP0        FOS   v7.0.1                STANDBY
              v7.0.1

```

5 CP1	FOS	v7.0.1	ACTIVE *
		v7.0.1	
7 FX8-24	FOS	v7.0.1	
		v7.0.1	

If you have one or more application blades in the chassis, the Fabric OS automatically detects mismatches between the active CP firmware and the application blade's firmware and triggers the auto-leveling process. This auto-leveling process automatically updates the application blade firmware to match the active CP. At the end of the auto-leveling process, the active CP and the application blades will run the same version of the firmware.

4. Pack the faulty CP blade in the packaging provided with the new CP blade for return to IBM, following local procedures.
5. Install the chassis door (See "Removing and installing the chassis door" on page 67.)

Removing and installing a CR16-4 core switch blade

This section describes how to remove and install a core switch blade. The SAN384B-2 has two core switch blades: one in slot 3 and one in slot 6. Note that the blade shown in Figure 36 on page 83 is shown with EMI plugs installed.

Verifying the necessity of replacement

Confirm that you need to replace the core switch blade before continuing. The following events might indicate that a core switch blade is faulty:

- The status LED on the core switch blade is lit steady amber, or the power LED is not lit.
- The **slotShow** command does not show that the core switch blade is enabled.
- The **haShow** command indicates an error.
- Any of the following messages display in the error log:
 - "Slot unknown" message relating to a core switch blade slot
 - core switch blade errors or I²C timeouts
 - FRU: FRU_FAULTY messages for a core switch blade
 - Configuration loader messages or "Sys PCI config" messages
 - Generic system driver messages ("FABSYS")
 - Platform system driver messages ("Platform")
 - Error messages that indicate a problem with a core switch blade
 - Function fail messages for the core switch blade master

For more information about error messages, refer to the *Fabric OS Message Reference*.

Time and items required

The installation procedure for the core switch blade takes approximately 30 minutes. The following items are required for the core switch blade replacement:

- ESD grounding strap
- #2 Phillips screwdriver
- Replacement CR16-4 core switch blade.

Removing a CR16-4 core switch blade

The SAN384B-2 continues to operate while a core switch blade is being replaced.

Attention: Follow ESD precautions (see “ESD precautions” on page xxi) whenever handling blades.

Note: The CR16-4 blade is compatible only with the SAN384B-2.

Complete the following steps to remove a CR16-4 core switch blade.

1. Remove the chassis door (see “Removing and installing the chassis door” on page 67).
2. Unscrew the two thumb screws from the ejectors on the blade using the Phillips screwdriver. Unscrew the left thumb screw until it pops out. This initiates a hot-swap request.
3. Label and then disconnect all cables from the faulty core switch blade.
4. Open the ejectors by rotating them toward the center of the blade face. Pull the blade out of the chassis using the ejectors (Figure 36).

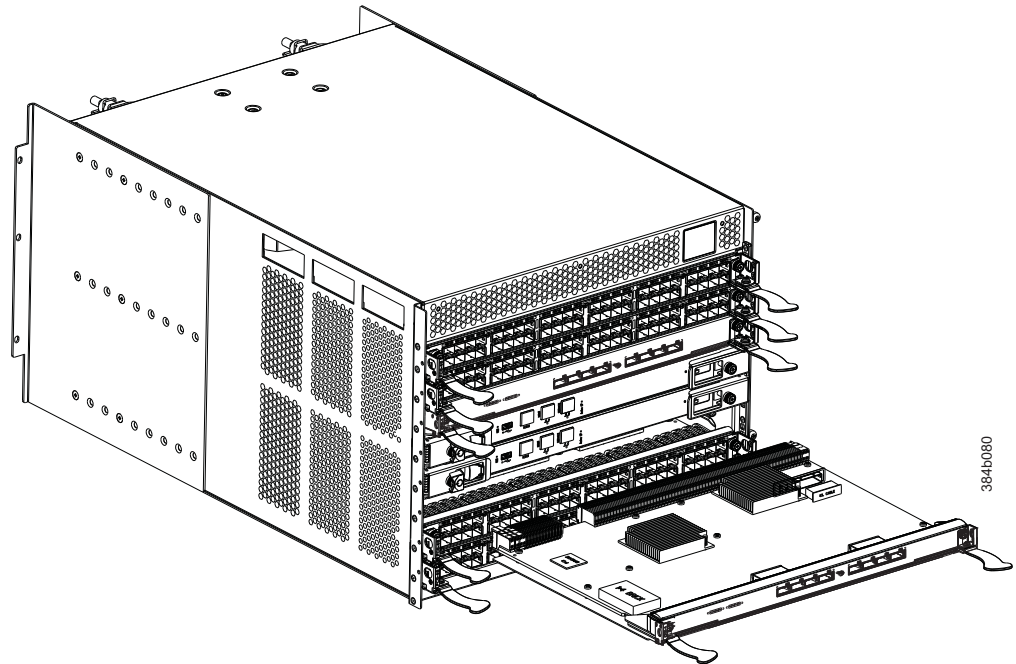

Figure 36. Removing and replacing the core switch blade

Installing a CR16-4 core switch blade

Attention: Follow ESD precautions (see “ESD precautions” on page xxi) whenever handling blades.

Note: The CR16-4 blade is compatible only with the SAN384B-2.

Complete the following steps to install a CR16-4 core switch blade (slot 3 or 6).

1. Open the ejectors by rotating them toward the center of the blade face. Orient the CR blade so that the handles are toward you and the flat metal side is on the bottom.

2. Align the flat side of the blade inside the left and right rail guides in the slot with the components facing upwards, and then slide the blade into the slot until it is firmly seated.
3. Close the ejectors by rotating them away from the center of the blade. The levering action of the ejectors seats the blade in the slot.
4. Power on the blade by screwing in the thumbscrews.
5. Verify that the power LED is green (this might require a few seconds). If not, ensure that the core switch blade has power and is firmly seated and that the ejectors are in the locked position.
6. The status LED on the new blade is initially amber and will remain amber until POST for the blade completes. This may take as long as several minutes. The LED will then turn green.
7. Connect the cables to the new core switch blade. If the QSFP cables (ICL) are not used, make sure the rubber gaskets are in the QSFP transceivers.
8. Install the chassis door. (See “Removing and installing the chassis door” on page 67.)
9. Pack the faulty core switch blade in the packaging provided with the new core switch blade for return to IBM, following local procedures.

Removing and installing a power supply

Use this procedure to remove and replace a power supply. The SAN384B-2 can continue operating during the replacement if the other power supply is operating.

Note: The SAN384B-2 base configuration includes two power supplies for full redundancy. Operating the system with a single functioning power supply runs the risk of data loss in the event of a second power supply failure. Both power supply slots should remain filled to ensure proper air circulation for system cooling.

Time and items required

The installation procedure for each power supply takes less than 5 minutes. A power supply unit or filler panel is required to replace the power supply being removed.

Removing a power supply

Figure 37 on page 85 shows the location of the two power supplies, which are located at the top of the non-port side of the SAN384B-2.

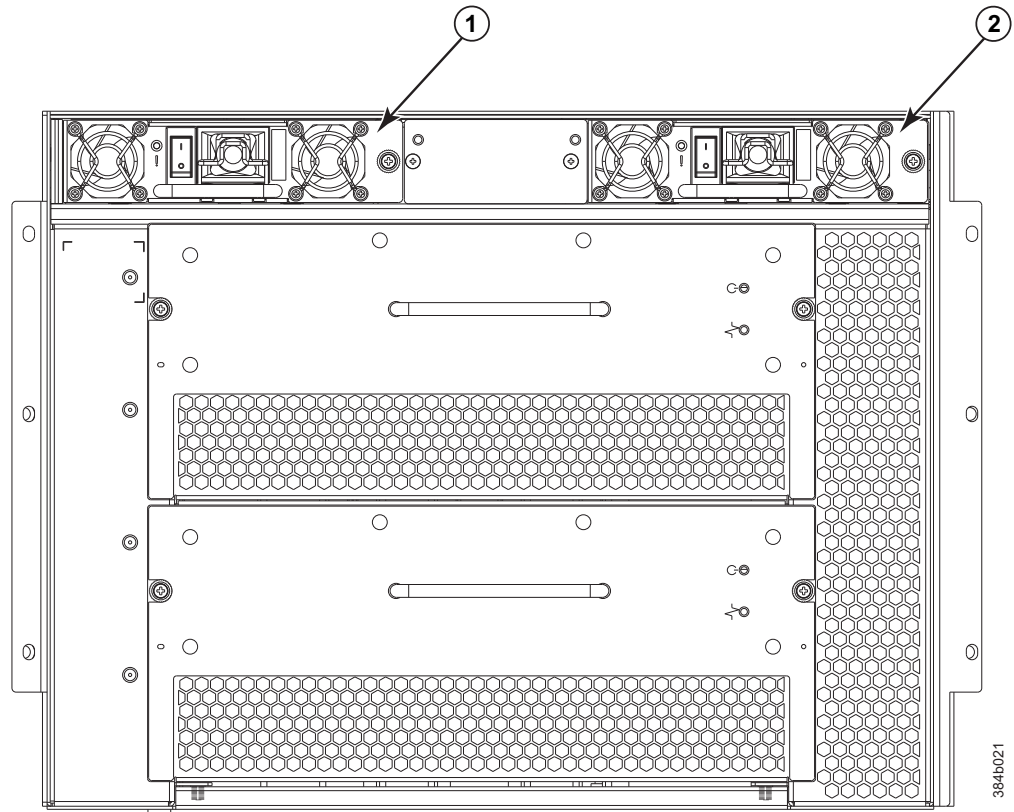

Figure 37. Location of the two power supplies

- | | | | |
|----------|----------------------|----------|----------------------|
| 1 | Power supply 1 (PS1) | 2 | Power supply 2 (PS2) |
|----------|----------------------|----------|----------------------|

Complete the following steps to remove a power supply.

1. Perform the appropriate following action based on whether the SAN384B-2 is operating:
 - If the SAN384B-2 is not operating during the replacement procedure, go to step 2.
 - If the SAN384B-2 is going to continue operating during the replacement, check the power LEDs to verify that the remaining power supply is functioning properly before continuing.
2. Turn off the power switch on the power supply you are replacing.
3. Disconnect the power cord.
4. Loosen the thumbscrew, using a Phillips screwdriver if necessary.
5. Grasp the handle and pull, sliding the power supply from the chassis (see Figure 38 on page 86). Support the power supply from beneath as you remove it.
6. If you are not immediately replacing the power supply, insert and attach a power supply filler panel into the slot to ensure proper air circulation for cooling.

Note: Two power supplies are required to provide redundancy, protecting against potential data loss.

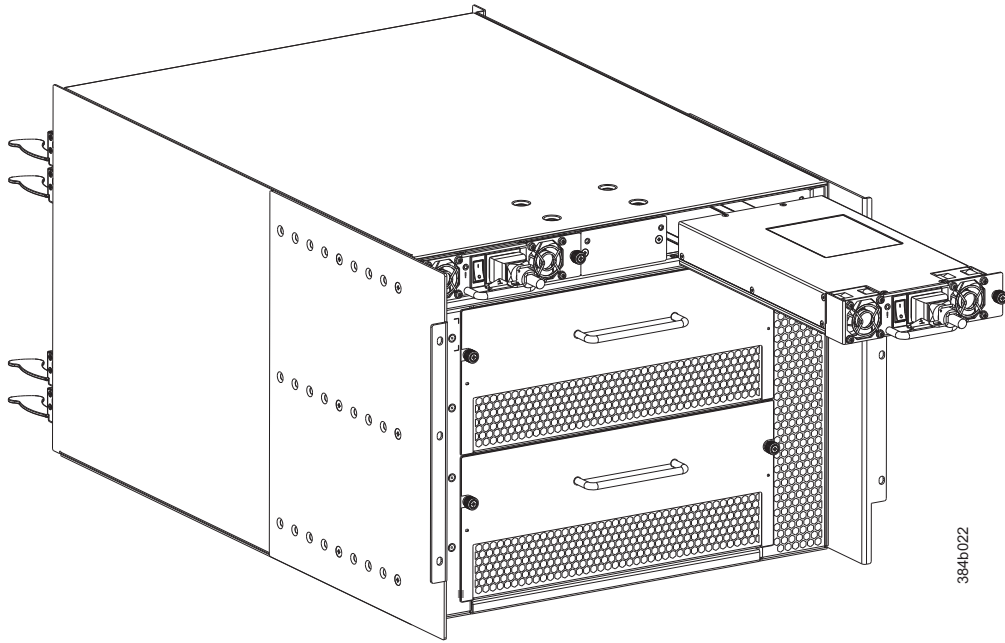

Figure 38. Removing and installing a power supply

Installing a power supply

Complete the following steps to install a power supply.

1. Remove any filler panels that were temporarily installed.
2. Insert the power supply into the slot. Verify that the power supply is seated by gently pulling on the handle. The power supply should resist movement as you pull.
3. Tighten the thumbscrew.
4. Connect the power cord.
5. Move the power supply switch to the on position.
6. Verify that the power LED on the power supply displays a steady green light.

Removing and installing a blower assembly

This procedure provides instructions for removing and installing a blower assembly.

Attention: The system can continue operating during the replacement if the second blower assembly is operating. To ensure continuous adequate cooling, maintain both blower assemblies except for the brief period during replacement.

Time and items required

The installation procedure for each blower assembly takes less than 5 minutes. The following items are required for the blower assembly installation:

- Replacement blower assembly
- #2 Phillips screwdriver

Removing a blower assembly

Complete the following steps to remove a blower assembly.

1. Before removing a blower assembly, verify that the other blower assembly is functioning correctly. The power LEDs should be steady green.
2. Use the screwdriver to loosen the captive screws at the left and right edges of the blower assembly.
3. Grasp the handle and pull, sliding the blower assembly from the chassis and supporting the blower assembly from beneath as you remove it (see Figure 39).

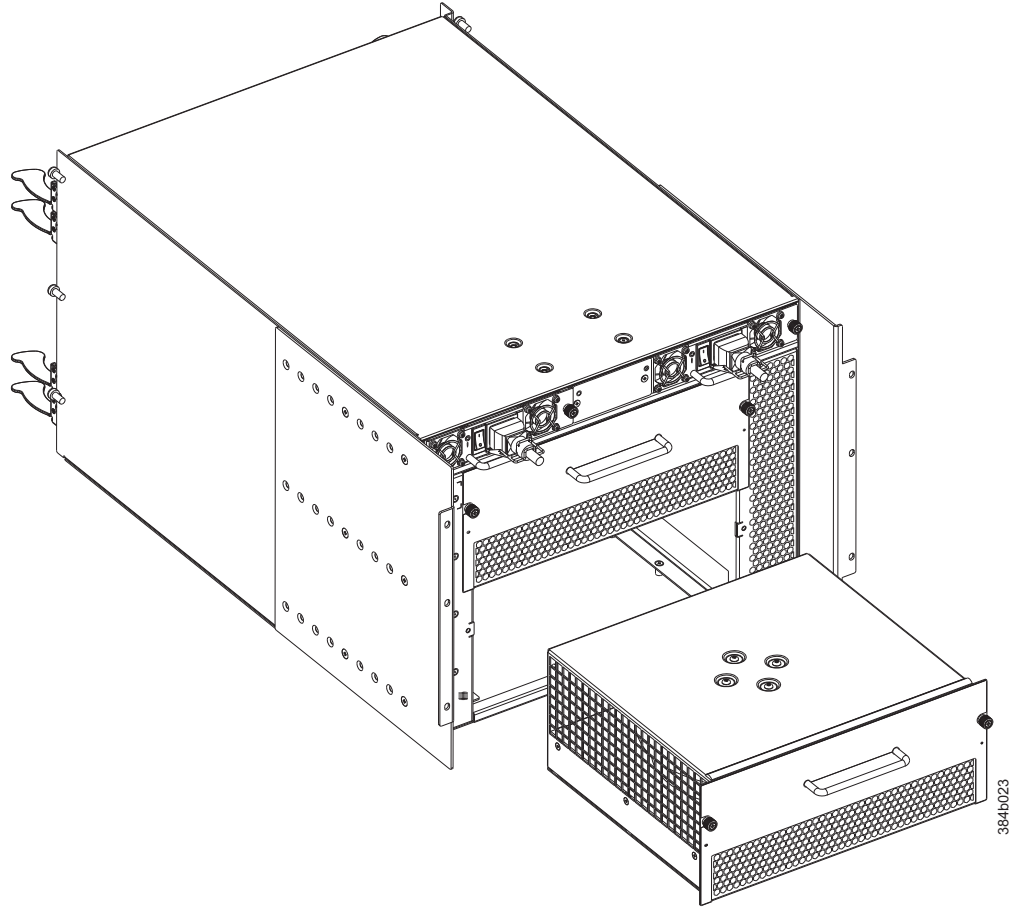

Figure 39. Blower assembly removal and replacement

Installing a blower assembly

complete the following steps to install a blower assembly.

1. Orient the blower assembly in front of the open slot and slide it into the chassis, pushing firmly to ensure that it is seated.
2. Verify that the power LED displays a green light.
3. Use the screwdriver or your fingers to tighten the captive screws.

Removing and installing a WWN bezel and WWN card

Note: The World Wide Name (WWN) cards contain fully redundant circuits and normally do not require replacement. Two WWN cards are located beneath the WWN bezel. The LEDs on the WWN cards are not visible unless the bezel is removed.

Time and items required

Allow approximately 20 minutes to install a WWN card. The following items are needed to replace a WWN card:

- ESD grounding strap
- #2 Phillips screwdriver (required only for some versions of the WWN card)
- If a serial console session is used: serial cable and a workstation computer with a terminal emulator application (such as HyperTerminal for Windows systems or TIP for UNIX systems)

Verifying necessity of replacement

Before replacing a WWN card, verify that the replacement is necessary. Any of the following events can indicate that the card requires replacement:

- Power or Status LEDs on WWN card (beneath the bezel) indicate a problem
- Problems viewing or modifying the data stored on the WWN card
- Error messages regarding WWN units #1 or #2

Removing the WWN bezel and WWN card

Attention: Follow ESD precautions (see “ESD precautions” on page xxi) whenever handling cards or blades.

Complete the following steps to remove the WWN bezel and WWN card.

1. Open a Telnet session to the SAN384B-2 and log in to the active CP as **admin**. The default password is **password**.
2. Verify you are logged into the active CP. Run the **haShow** command to determine the active CP.
3. Run the **supportSave** command on the active CP to capture all settings. If any problems occur during the replacement, the information will be important for solving the problem.
4. Connect yourself to the ESD grounding strap.
5. Remove the two screws from the WWN bezel . Pull the bezel away from the chassis and set it aside (see Figure 40 on page 89). The WWN cards and their status LEDs are visible.
6. Wait until all the LEDs on the WWN cards turn off.
7. Use a Phillips screwdriver to unscrew the two screws that secure the WWN card to the chassis. Hold the card by the edges and pull out to remove it.
8. Disconnect the WWN cable by depressing the cable connector latch and pulling the connector from the WWN module.
9. Set the WWN card on a static-free surface, such as a grounding pad.

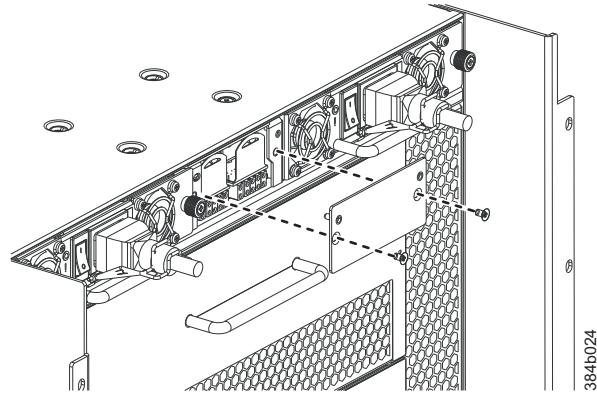

Figure 40. WWN bezel and card removal and installation

Installing the WWN bezel and WWN card

Complete the following steps to install the WWN bezel and WWN card.

Attention: Follow ESD precautions (see “ESD precautions” on page xxi) whenever handling cards or blades.

1. Unpack the new WWN card and save the packaging for returning the faulty WWN card.
2. Hold the card by the edges and insert the WWN cable onto the WWN module until it is fully seated. Use the Phillips screwdriver and the two screws to attach the WWN card to the chassis.

Note: If a serial console session is active, several “removal detected” and “insertion detected” messages display on the console because of the replacement.

3. Verify that the WWN card is correctly connected by checking the LEDs on the WWN card to see if they reflect the status of the components.

Note: The LEDs might take up to 2 minutes after WWN card installation to begin functioning.

4. Install the WWN bezel. Orient the bezel on the chassis (Figure 40). Insert and tighten the two screws.
5. Pack the faulty WWN card in the packaging provided with the new card for return to IBM, following local procedures.

Removing and installing transceivers

Note: For a listing of transceivers compatible with this product:

- Go to the IBM SAN web page www.ibm.com/systems/storage/san
- Select the **IBM System Storage SAN768B-2 and SAN384B-2** product link
- On the displayed product page, click the **Interoperability Matrix** link in the **Learn more** section.
- In the Interoperability matrix, click the **Transceivers** link.

Note: The 16 Gbps-capable SFP+s auto-negotiate at 4, 8, and 16 Gbps. The single-speed 10 Gbps SFP+s can also be used in the 16 Gbps port blades.

The 8 Gbps-capable mSFPs and SFP+s auto-negotiate at 2, 4, and 8 Gbps. The mSFPs are compatible only with the FC8-64 high density port blade. The 16 Gbps SFP+s should be used only with the FC16-32 and FC16-48 port blades.

Time required

The replacement procedure for one transceiver takes less than five minutes

Items required

- Replacement mSFP or SFP+
- Optical transceiver extraction tool (for SFP+ transceivers)

Removing and installing an SFP+ optical transceiver

The SAN384B-2 comes with a transceiver extraction tool (see Figure 41) and holster. The extraction tool is designed to remove transceivers from blades where the space is limited.

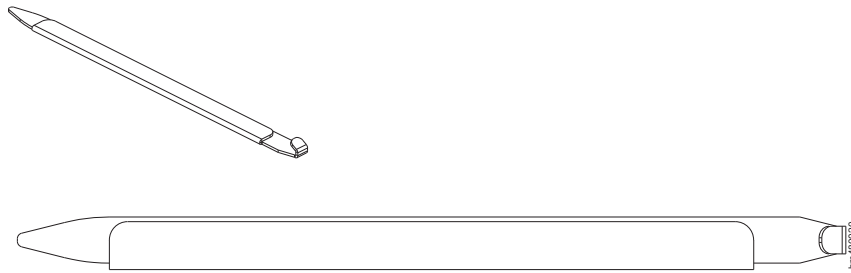

Figure 41. Optical transceiver (SFP+) extraction tool

The 16 Gbps SFP+ transceivers have an attached pull tab similar to the mSFPs and have no latching wire bail. To simplify insertion of the 16 Gbps SFP+ transceivers, it is recommended to connect the cables first, and then insert them as a unit into the port. These SFP+ transceivers do not require the extraction tool.

Note: This tool is part of the SAN384B-2 ship group and should be kept with the chassis.

Attention: mSFP optical transceivers should not be inserted into ports intended for SFP+ transceivers. They will be faulted on power-up.

Removing an SFP+ optical transceiver

Complete the following steps to remove an SFP+ transceiver.

Note: The 16 Gbps SFP+ transceivers have an attached pull tab like the mSFPs. Instead of using the extraction tool, simply grasp the pull tab and pull it straight out to remove the 16 Gbps SFP+ and the connected cable from the port. See the mSFP transceiver in Figure 44 on page 92 for the basic appearance of the 16 Gbps transceiver. Detach the cable from the 16 Gbps SFP+ once you have disconnected the unit from the port.

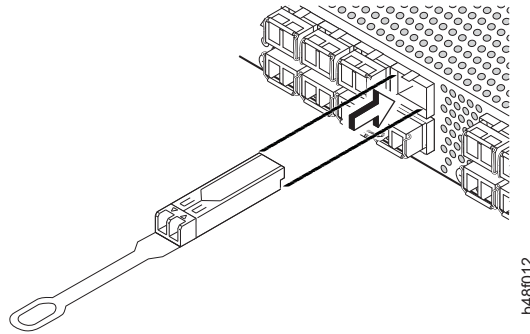

Figure 42. Installing and removing a 16 Gbps SFP+ with pull tab (shown without cable attached)

Complete the following steps to remove an SFP or SFP+ with a wire bail.

1. Remove any cables that are inserted into the transceiver. Use the extraction tool to open the cable latching mechanism.
2. Using the hooked end of the tool, pull the bail (wire handle) **1** away from its pivot point and out, sliding the transceiver out of the port (Figure 43).

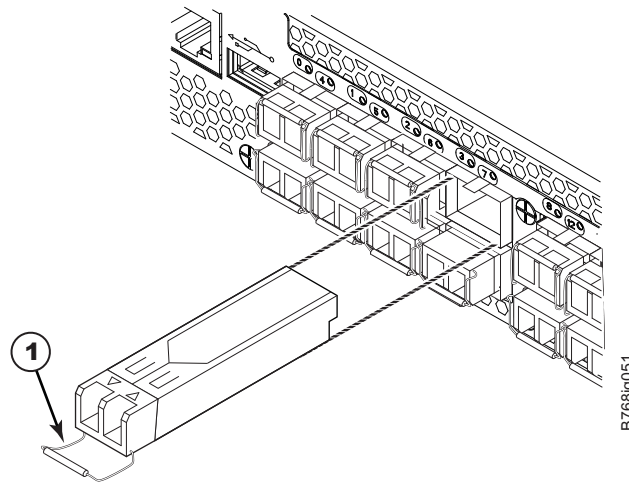

Figure 43. Removing and replacing an SFP+ optical transceiver

3. Set the transceiver on a static-free surface, such as a grounding pad.

Installing an SFP+ transceiver

Complete the following steps to install an SFP+ transceiver.

Note: The 16 Gbps SFP+ transceivers have an attached pull tab like the mSFPs. See the mSFP transceiver in Figure 44 on page 92 for the basic appearance of the 16 Gbps transceiver. Connect the cable to the 16 Gbps SFP+ first, and then insert the SFP+/cable unit into the port, using the pull tab to help push the transceiver and cable into the port.

1. For SFPs and SFP+ transceivers with wire bails, make sure that the bail (wire handle) is in the unlocked position. Align the optical transceiver so that the key is oriented correctly to the port. Insert the transceiver into the port until it is firmly seated and the latching mechanism clicks, and then close the bail. Transceivers are keyed so that they can only be inserted with the correct orientation. If a transceiver does not slide in easily, ensure that it is correctly oriented.

- Position a cable so that the key (the ridge on one side of the cable connector) is aligned with the slot in the transceiver. Insert the cable into the transceiver until the latching mechanism clicks. Cables are keyed so that they can be inserted in only one way. If a cable does not slide in easily, ensure that it is correctly oriented.

Attention: Do not insert a cable intended for an mSFP transceiver into a regular SFP+ transceiver. You may damage the cable.

Removing and installing an mSFP optical transceiver

Use this procedure to remove and install mSFP transceivers. Do *not* use the extraction tool to remove mSFP transceivers

Note: The mSFP transceivers are used only with the FC8-64 port blade. Narrower OM-3 LC cables are used to connect the FC8-64. These cables are offered by several major manufacturers. Contact your IBM representative for options regarding different cable and patch panel configurations to simplify cable management with higher density FC8-64 port blades. Cables for mSFP transceivers should not be used with standard SFP+ transceivers.

Attention: mSFP optical transceivers should not be inserted into ports intended for SFP+ transceivers. They will be faulted on power-up.

To replace an mSFP transceiver, complete the following steps. Due to high port and cable density, it is recommended that the optical cable be either removed from or inserted into the mSFP while the transceiver is out of the switch or blade.

Removing an mSFP transceiver

Attention: The pull tabs are not designed to be bent. Doing so may result in damage to the pull tab.

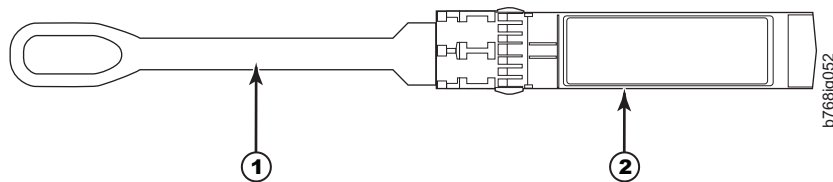

Figure 44. Optical mSFP transceiver

- | | | | |
|----------|----------|----------|------------------|
| 1 | Pull tab | 2 | mSFP transceiver |
|----------|----------|----------|------------------|

To remove an mSFP transceiver, complete the following steps.

- Grasp the pull tab **1** firmly and pull the unit (including the cable) out of the port.
- Remove the cable from the transceiver.
- Set the transceiver on a static-free surface, such as a grounding pad.

Installing an mSFP transceiver

To install an mSFP transceiver, complete the following steps.

- Insert the cable into the new transceiver until the latching mechanism clicks.
- Position the optical transceiver so that the key is oriented correctly to the port. Insert the transceiver into the port until it is firmly seated and the latching mechanism clicks.

Transceivers are keyed so that they can only be inserted with the correct orientation. If a transceiver does not slide in easily, ensure that it is correctly oriented.

Removing and replacing inter-chassis link (QSFP) cables

Use this procedure to remove and install QSFP cables.

Note: ICL ports can be used only with an ICL license. After the addition or removal of a license, the license enforcement is performed on the ICL ports only when the **portDisable** and **portEnable** commands are issued on the ports. An ICL license must be installed on all systems forming the ICL connection. Beginning with Fabric OS v7.0.1, up to nine neighboring SAN384B-2 and SAN768B-2 chassis can be connected with the QSFP cables. With Fabric OS v7.0.0, a maximum of six chassis can be connected. An off-the-shelf QSFP cable up to 50 meters long can be used as an ICL cable.

Attention: If QSFP cables are not in use, make sure the rubber gaskets are in the QSFP transceivers.

Table 15 describes the ICL connector port LED patterns and the recommended actions for those patterns.

Table 15. ICL connector port LEDs

LED purpose	Color	Status	Recommended action
QSFP connector status	No light (LED is off)	No QSFP module, all four QSFP ports are disabled	No action is required if QSFP is not present or verify that the QSFP is fully inserted.
	Steady amber	QSFP module is in, all four ports have no signal/no sync.	No action is required if only the QSFP is installed; or ensure that the cable is properly connected. If the LED remains amber, contact IBM.
	Blinking amber	Port is disabled or faulted, FC link activity, segmented, loopback mode, also during transition between QSFP cable insertion and confirmation.	Check for console messages or wait for all four ports to come online.
	Steady green	Both ends of QSFP cable are in and all ports are online. Full link is established.	No action required.

Complete this procedure to remove and install the ICL cables. Refer to the *Fabric OS Administrator's Guide* for the configuration procedure and requirements.

Figure 45 shows an QSFP cable and transceiver. The QSFP connectors on the core blades are labeled by trunk group (trunking is optional) for ease of installation. The subsequent figures, beginning with Figure 47 on page 96, show acceptable cabling configurations for the ICL feature. The recommended topology is the parallel type where there are four QSFP cables connected between any pair of SAN384B-2 or SAN768B-2 chassis. The full mesh configuration is also supported.

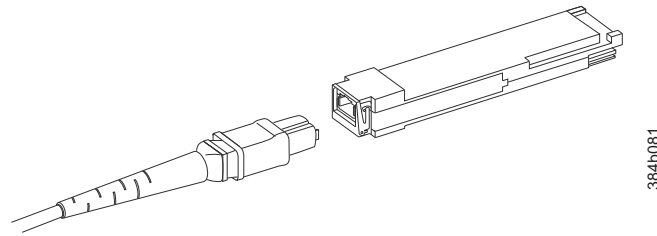

Figure 45. QSFP cable and transceiver

Time and items required

The replacement procedure for an QSFP cable takes less than five minutes. You will need a replacement QSFP cable and transceiver (if necessary).

Removing an inter-chassis link (QSFP) cable

Complete the following steps to remove a QSFP cable.

1. Remove the chassis door (“Removing and installing the chassis door” on page 67).
2. If you are replacing an ICL cable, note the cable routing, paying attention to which cable end plug into which socket. Replace only one ICL cable at a time to minimize errors.
3. Grasp the rubber housing on the end of the cable and pull it straight out of the QSFP transceiver.
4. If the QSFP transceiver also needs to be replaced, remove the QSFP transceiver by rotating the bail down and using the bail to pull the transceiver out of the connector on the blade.

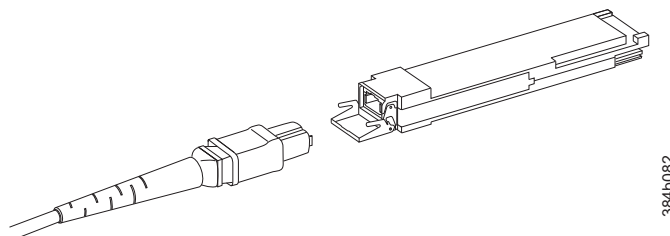

Figure 46. QSFP cable and transceiver (bail open)

5. Repeat for each cable that requires replacement.
6. If you are not replacing the ICL cables, insert the rubber plugs into each QSFP transceiver.

Installing an ICL cable

Complete the following steps to install a QSFP cable.

1. If the QSFP transceiver is being replaced, grasp the bail of the new QSFP and push the QSFP into the connector on the blade until it is firmly seated. The QSFP is keyed to fit into the connector in one way. The status LED initially blinks amber after installation, then displays steady amber.
2. Grasp the QSFP cable by the rubber housing and push it into the QSFP transceiver until it is firmly seated. The cable housing is keyed to fit into the QSFP in one way.
The status LED displays steady amber until both ends of the cable are inserted and the link is established. When the link is fully established, the LED displays steady green.
3. Repeat for each cable that you are installing.
If you are installing ICL cables for the first time, pay particular attention to the configuration in which the cables must be installed. See “Possible ICL configurations” for one possible configuration between two chassis.
4. Replace the chassis door (“Removing and installing the chassis door” on page 67).
5. Once all the cables are attached, see the *Fabric OS Administrator’s Guide* for the configuration procedure.

Possible ICL configurations

| Figure 47 on page 96 illustrates one possible QSFP cable configuration between two
| SAN384B-2 or SAN768B-2 chassis. Each of two cores in one chassis should be
| interconnected with each of two cores in the second chassis. This provides for
| inter-chassis link (ICL) trunking between chassis, ensuring redundancy. Parallel
| connections between core blades are recommended.

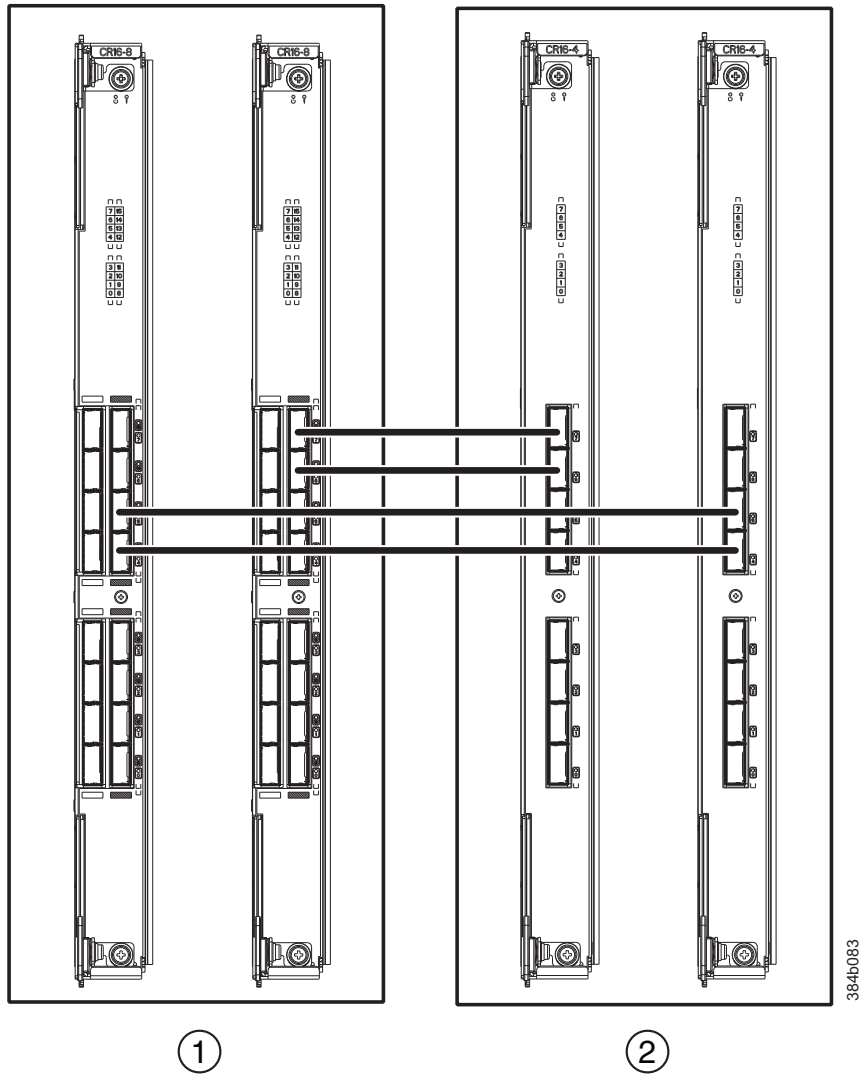
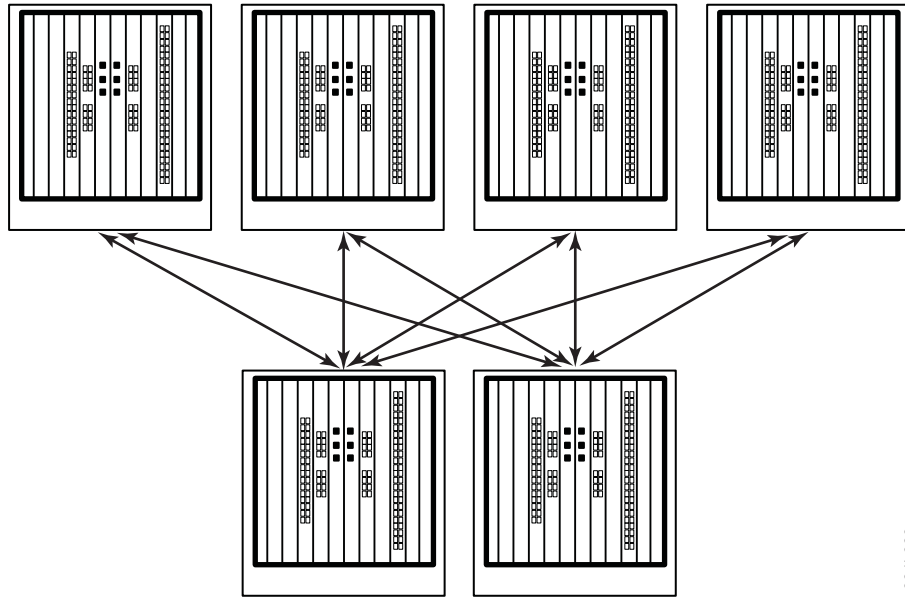

Figure 47. QSFP cable connections for two SAN768B-2 chassis (sample configuration)

1 Chassis 1 (SAN768B-2)

2 Chassis 2 (SAN768B-2)

SAN384B-2 and SAN768B-2 chassis can be connected in a core/edge configuration. Figure 48 on page 97 shows two core and four edge chassis. Although only SAN768B-2 chassis are shown in the figure, the chassis can be any combination of SAN384B-2 and SAN768B-2. The cabling scheme should follow the parallel example shown in the Figure 47. Each line in the Figure 48 on page 97 actually represents four cables running between the chassis.



384b089

Figure 48. Core/edge ICL topology for SAN384B-2 and SAN768B-2 chassis

SAN384B-2 and SAN768B-2 chassis can also be connected in a full mesh configuration as shown in Figure 49 on page 98. The SAN768B-2 chassis are shown in the figure, but either chassis can be connected. In this example, the three trunk groups are shown in different shades.

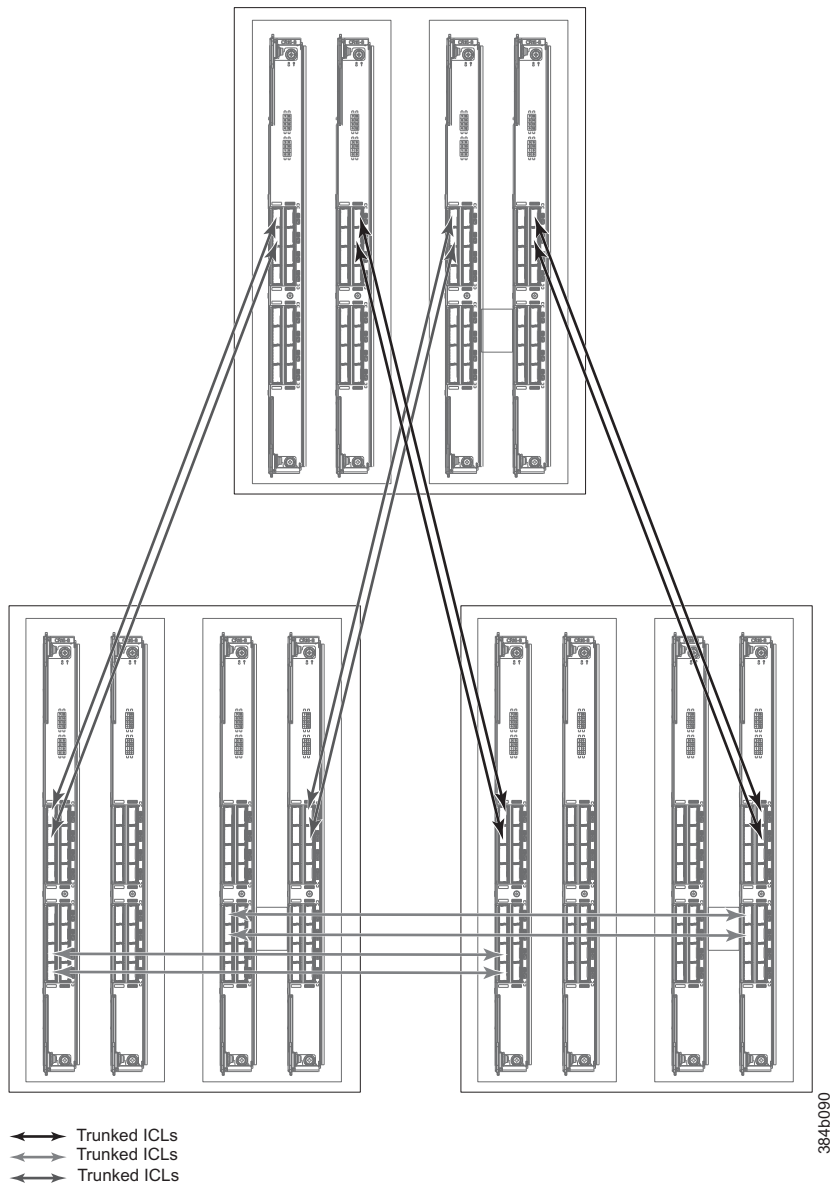

Figure 49. full mesh ICL topology for SAN384B-2 and SAN768B-2 chassis

Removing and replacing a SAN384B-2 chassis

This section describes how to remove and replace the SAN384B-2 chassis (with its backplane). The basic steps are:

- “Verifying need for replacement” on page 99
- “Recording critical SAN384B-2 and SAN information” on page 99
- “Disconnecting from the network and fabric” on page 102
- “Removing components from the chassis” on page 103
- “Removing a SAN384B-2 from the cabinet” on page 104
- “Installing the replacement chassis” on page 105
- “Installing components into the new chassis” on page 105

- “Verifying correct operation of system” on page 107
- “Reconnecting the system to the network and fabric” on page 108
- “Verifying correct configuration of the fabric” on page 108

Note: The SAN384B-2 must be removed from the fabric and powered off to perform this procedure. Contact IBM Support if you have any questions about whether the chassis requires replacement.

Time required

The chassis replacement takes approximately 3 hours.

Items required

The following items are required for the chassis replacement:

- ESD grounding strap
- ESD grounding pads for protecting all blades and WWN cards
- Serial cable and workstation computer with a terminal emulator application (such as HyperTerminal for Windows systems or TTP for UNIX systems), required only if serial console session used
- Hydraulic lift (see “Ordering the lift tool” on page 12) that raises a minimum of 140 cm (55 in.) and carries a minimum of 113 kg (250 lb)
- A surface to place the old chassis on, such as a second lift or the pallet originally provided with the old chassis
- #2 Phillips screwdriver

Verifying need for replacement

Verify that replacement of the chassis is necessary. Ensure that the components are firmly seated when troubleshooting, and contact IBM support with any questions about whether the chassis should be replaced. Any of the following events might indicate the need to replace the chassis:

- Visible mechanical damage to the chassis, including damage to sheet metal or card guides that prevents correct installation of a blade.
- Bent or damaged connectors on the backplane (the surface inside the chassis to which the blades connect).
- One or more components (such as a power supply, blower assembly, port blade, control processor blade, core switch blade, or WWN card) do not function properly even after the component was replaced.
- Intermittent FAULTY codes for blades. Re-seat the blade and visually inspect the right-hand ejector stiffening rail for possible wear or damage. It is important that the blade ejector handles not slip out during blade installation. If this happens, it is usually due to excessive wear or damage to the right-hand ejector stiffening rail.
- The **psShow** or **fanShow** commands continue to show a faulty component even though the component was replaced.
- The **slotShow** command continues to show a faulty control processor, core switch, or port blade even though the blade was replaced.

Recording critical SAN384B-2 and SAN information

All commands must be entered from a CLI session (Telnet or serial) to the active CP blade unless otherwise indicated.

Note: Run **supportShow** which includes all of the information in Table 16 and more. The customer should record the location of the .txt files, which are created by the customer and are not called out in the **supportShow** results.

For detailed information about Fabric OS commands, refer to the *Fabric OS Command Reference Manual*. Use a checklist (Table 16) to ensure that all required information is recorded.

Table 16. Critical information checklist example

Checked?	Data	Notes
Configuration information		
	Location of "config-switch.txt" file	
	Location of "config-miscinfo.txt" file	
	IP address, subnet mask	
	WWN for SAN384B-2	
SAN profile		
	Location of "SANbefor.txt" file	
	Notes regarding nsShow output	
	Notes regarding nsAllShow output	
	Notes regarding switchShow output	
	Notes regarding fabricShow output	
Output from supportShow command		
	Location of "spptshow.txt" file	
	Notes regarding supportShow output	
Information about the new chassis		
	New factory serial number	
	New serial number (if available)	

1. Open a Telnet session and log in to the SAN384B-2 as **admin**. The default password is **password**. Enable the logging function on your Telnet or serial console connection.
2. Back up the current configuration.

Note: If you are using the virtual fabric feature, run **configUpload -vf** before running the **configUpload** command in order to save the logical switch configuration.

Enter **configUpload -all**; then enter the requested information at the prompts. This command uploads the configuration to the customer-defined FTP server, making it available for downloading. For more information about this command, refer to the *Fabric OS Command Reference Manual*.

```
switch:admin> configupload -all
Protocol (scp or ftp) [ftp]: ftp
Server Name or IP Address [host]: 123.123.123.123
User Name [user]: Admin24
File Name [config.txt]: config-switch0.txt
Password: xxxxxxxx
Upload complete
switch:admin>
```

Alternatively, you can save the configuration file to the USB device.

- Record the WWN value: Enter **wwn**; then, copy the command output into a file named "config-miscinfo.txt".

```
switch:admin> wwn
10:00:00:60:69:00:00:0a
```

- Record the IP address information.

Enter **ipAddrShow -sw**; then copy the command output into the "config-miscinfo.txt" file.

```
switch:admin> ipaddrshow -sw
```

```
SWITCH
Ethernet IP Address: 10.32.50.12
Ethernet Subnetmask: 255.55.0.0
Fibre Channel IP Address: 1.2.3.4
Fibre Channel Subnetmask: 255.255.255.0
```

```
CP0
Ethernet IP Address: 10.32.50.10
Ethernet Subnetmask: 255.55.0.0
HostName : cp0
Gateway Address: 10.32.40.1
```

```
CP1
Ethernet IP Address: 10.32.50.11
Ethernet Subnetmask: 255.55.0.0
HostName : cp1
Gateway Address: 10.32.40.1
```

```
Backplane IP address of CP0 : 10.0.0.4
Backplane IP address of CP1 : 10.0.0.5
switch:admin>switch:admin>
```

- Display and record the manufacturer serial numbers.

Enter **chassisShow**; then copy the command output into the "config-miscinfo.txt" file.

"Factory Serial Num" and "Serial Num" are listed under "Chassis/WWN Unit 1." If the current WWN cards are the original cards, the factory serial number listed is the same as the chassis serial number.

```
switch:admin> chassisshow
```

```
Chassis Backplane Revision: 1F
```

```
SW BLADE Slot: 1
Header Version: 2
Power Consume Factor: -50
Factory Part Num: 60-0001532-03
Factory Serial Num: KP000000195
Manufacture: Day: 1 Month: 1 Year: 2011
Update: Day: 14 Month: 3 Year: 2012
Time Alive: 187 days
Time Awake: 3 days
```

```
<output truncated>
```

```
CHASSIS/WWN Unit: 1 (in same assembly as WWN Unit: 2)
Header Version: 2
Power Consume Factor: -3
Factory Part Num: 60-0001501-07
Factory Serial Num: FT02X805BE2
Manufacture: Day: 26 Month: 1 Year: 2011
Update: Day: 14 Month: 3 Year: 2012
Time Alive: 207 days
Time Awake: 3 days
```

<output truncated>

switch:admin>

6. Create a SAN “profile” by entering and recording the information provided by the following commands:

- **nsShow**
- **nsAllShow**
- **switchShow -qsfp**
- **fabricShow**

Copy the command output into a text file named “SANbefor.txt”. After the SAN384B-2 is restored to the fabric, this information can be used to verify that no unintentional changes have occurred to the fabric.

```
switch:admin> nsshow
Enter Pid COS PortName NodeName TTL
<output truncated>
```

```
switch:admin> nsallshow
12 Nx_Ports in the Fabric
<output truncated>
```

```
switch:admin> switchshow -qsfp
switchName: switch
<output truncated>
```

```
switch:admin> fabricshow
Switch ID Worldwide Name Enet IP Addr FC IP Addr Name
<output truncated>
```

7. Enter **supportShow**; then copy the command output into a text file named “spptshow.txt”.

Note: The **supportShow** command has a very long output and time for completion. It may last 20 minutes or longer depending on the size of the SAN.

This file provides a backup of all the information that might be required by Technical Support. The information can be used after the SAN384B-2 is restored to the fabric, to verify that no unintentional changes have occurred to the fabric.

```
switch:admin> supportshow
version: 7.0.0
<output truncated>
```

switch:admin>

8. Record the cable connections between the SAN384B-2 and the target devices and ports, if you have not previously done so. See Table 17 on page 110 for a sample template.
9. Run **supportSave** on the active CP. The information recorded can be very important in case you have difficulties during the replacement process.

Disconnecting from the network and fabric

1. Shut down the SAN384B-2 using the **sysShutdown** command on the active CP.

```
switch:admin> sysshutdown
This command will shutdown the operating systems on your switch.
You are required to power-cycle the switch in order to restore operation.
Are you sure you want to shutdown the switch [y/n]? y
HA is disabled
Stopping blade 1
```

```

Shutting down the blade....
Stopping blade 2
Shutting down the blade....
Stopping blade 8
Shutting down the blade....
Broadcast message from root (pts/1) Tue Jul 18 14:23:06 2008...
The system is going down for system halt NOW !!

```

2. Power off the chassis by flipping all AC power switches to **O**. (The power supply status LED should turn off.)

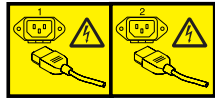

DANGER

Multiple power cords. The product is equipped with multiple power cords. To remove all hazardous voltages, disconnect all power cords. (L003)

3. Remove the power cords from the power supplies and the power outlets.
4. Remove the chassis door (see “Removing and installing the chassis door” on page 67).
5. Label the cables connected to all blades and record the connections in Table 17 on page 110.
6. Disconnect the cables from SFP+ transceivers in the application and port blades and set them aside. If you have mSFP transceivers in FC8-64 port blades, remove the transceivers and cables together and set them aside. The SFP+ transceivers can be left in the port blades or removed.
7. Disconnect all cables from the control processor and core switchblades.
8. Disconnect any ICL or QSFP cables (“Removing and replacing inter-chassis link (QSFP) cables” on page 93).

Removing components from the chassis

Attention: Follow ESD precautions (see “ESD precautions” on page xxi) when handling components.

1. Remove the cable management fingers (“Removing and installing cable management finger assemblies” on page 68).
2. Remove the port and application blades and filler panels (“Removing and installing port, application, and encryption blades” on page 70 and “Removing and installing blade filler panels” on page 72).
3. Remove the core switch blades (“Removing and installing a CR16-4 core switch blade” on page 82).
4. Remove the control processor blades (“Removing and installing a CP8 control processor blade” on page 73).
5. Remove the power supplies (“Removing and installing a power supply” on page 84).
6. Remove the blower assemblies (“Removing and installing a blower assembly” on page 86).
7. Remove the WWN bezel and WWN cards (“Removing and installing a WWN bezel and WWN card” on page 88).
8. Remove the chassis from the rack and port side exhaust kit (“Removing a SAN384B-2 from the cabinet” on page 104).

Note: If the chassis being removed was factory installed, additional shipping braces were added for stability during shipment. These consist of L-brackets and flat mounting plates. The mounting plates are attached on either side at the blower end of the chassis. The L-brackets secure the mounting plates to the cabinet vertical rails. Detach the L-brackets from the mounting plates and the cabinet rails before removing the chassis from the cabinet. If you anticipate that the cabinet with an installed chassis may be shipped to another location in the future, it is recommended that you attach these shipping brackets to any replacement chassis. Take note of how the brackets are assembled and attached when you remove them from the old chassis.

Removing a SAN384B-2 from the cabinet

These instructions describe how to use the lift tool (PN 09P2481) and the 24-inch load plate (PN 11P4369) to remove a SAN384B-2 from the cabinet. These instructions are only for the actual physical removal of a chassis from a 2109-C36 cabinet. These instructions assume that the SAN384B-2 you are removing is fully shut down and not connected to the fabric. The instructions can be used for moving a SAN384B-2 to a new location, or when replacing a defective chassis. See “Removing and replacing a SAN384B-2 chassis” on page 98 for complete steps required for shutting down the system and removing components before removing the chassis from the cabinet. If you are only relocating the chassis, you can skip the steps for removing components.

1. Assemble the lift tool if it is not assembled. The assembly and disassembly instructions are included with the lift tool. Additional instructions are also in “Unpacking and assembling the lift tool” on page 16.
2. Remove the two screws holding each vertical cable management finger assembly from the cabinet vertical rails, and remove the additional screw securing the chassis to the cabinet rails.
3. Remove the chassis door from the chassis by grasping the door on both edges and pulling straight out.
4. If any cables remain attached to the chassis, disconnect them.
5. If the chassis was factory installed in the cabinet, there may be additional shipping brackets attached to the non-port (blower assembly) side of the chassis, connecting the chassis to the cabinet rails. Remove the screws attaching the L-brackets to the cabinet rails, and the screws attaching the L-brackets to flat mounting plates that are connected to the sides of the chassis.
6. Disconnect both power cords from the SAN384B-2 if they are still attached.
7. Move the lift tool to a position near the rear of the cabinet.
8. Turn the winch crank clockwise to raise the load plate to a height slightly below the exhaust kit shelf.
9. Turn the winch crank counterclockwise 1/4 turn to set the winch brake.
10. Set the lift tool wheel brake.



CAUTION:

A fully populated SAN384B-2 weighs approximately 68 kg (150 lb) and requires a minimum of two people and a lift tool to install it. (C011)

11. Release the spring-loaded pins under the load plate, and pull the middle section of the load plate to the full extension. You may need to release the pin

closest to the cabinet to allow the middle section to fully extend. Make sure the spring-loaded pin snaps back into place. The gap between the end of the load plate middle section and the port side exhaust kit shelf should be no more than 2.5 cm (1 in.). If the gap is larger than this, either the lift tool is not positioned close enough to the cabinet, or the load plate middle section is not fully extended. Adjust as needed.

12. Carefully slide the chassis from the cabinet onto the 24-inch load plate. Center the chassis on the platform.
13. Release the spring-loaded pins under the load plate, and pull the middle section of the load plate back into the load plate.
14. Install the retention straps to secure the chassis to the lift tool.
15. Release the lift tool wheel brake, and move the lift tool away from the cabinet.
16. Lower the load platform to its lowest position.
17. Use the lift tool to relocate the chassis to the desired location.

Installing the replacement chassis

Attention: Refer to “Rack safety” on page xxii before starting the installation.



CAUTION:

The weight of this part or unit is more than 55 kg (121.2 lb). It takes specially trained persons, a lifting device, or both to safely lift this part or unit. (C011)

>55kg (121.2 lb)

The following instructions require that the port-side exhaust kit is already installed. If the rack does not have this shelf and exhaust duct installed, refer to “Installing the port-side exhaust kit” on page 18 for complete instructions.

1. Follow the steps in “Unpacking the SAN384B-2” on page 17 to unpack the replacement chassis.
2. Follow the steps in “Installing the SAN384B-2 into the cabinet” on page 25 to complete the installation of the replacement chassis. You can either install the empty chassis now, or first install the components steps 1-7 (“Installing components into the new chassis”) before completing the chassis installation.

Note: If you anticipate that the replacement chassis may be shipped to a new location while installed in the cabinet, it is recommended that you attach the shipping brackets to any replacement chassis. These shipping brackets consist of flat mounting plates that are attached to the sides of the chassis at the blower assembly end, and L-brackets that attach to the mounting plates and the cabinet vertical rails.

Installing components into the new chassis

Attention: Follow ESD precautions (“ESD precautions” on page xxi) whenever handling components.

1. Install the WWN cards and WWN bezel (“Installing the WWN bezel and WWN card” on page 89).
2. Install the blower assemblies (“Installing a blower assembly” on page 87).
3. Install the power supplies (“Installing a power supply” on page 86).

4. Install the control processor blades (“Installing a control processor blade (CP8)” on page 77).
5. Install the core switch blades (“Installing a CR16-4 core switch blade” on page 83).
6. If ICL cables are not used, insert rubber plugs into the QSFP transceivers if installed in the core switch blades (CR16-4).
7. Replace the port and application blades or filler panels (“Installing a blade” on page 72 and “Installing a filler panel” on page 73).
8. If the chassis is not yet installed in the rack, follow the steps in “Installing the SAN384B-2 into the cabinet” on page 25.
9. Replace the cable management fingers (“Installing a cable management finger assembly” on page 69).
10. Connect the power cords to the power supplies and the power outlets.
11. Replace the chassis door (“Removing and installing the chassis door” on page 67)
12. Power on the system (“Providing power to the SAN384B-2” on page 35). The system performs a power-on self-test (POST). The POST takes a minimum of three minutes and is complete when LED activity returns to standard state.
13. Verify that the SAN384B-2 is powered on and POST is complete (all power LED indicators on the port, control processor, and core switch blades should be a steady green).
14. Verify that all components are functioning correctly by checking their LEDs. If the LEDs do not indicate correct operation, try reinstalling the corresponding component.

Downloading the configuration

Once the chassis and its various components have been reassembled and powered back on, use the **configDownload** command to restore the original configuration. The **configDownload** command can be entered through a Telnet or serial session, but the SAN384B-2 must have an Ethernet connection to the server name or IP of the host for the download process to complete. For more information, refer to the **help configdownload** command or the *Fabric OS Command Reference Manual*.

To download the configuration, complete the following steps.

1. Log in to the SAN384B-2 as **admin**:

```
switch:admin> login
login: admin
password: xxxxxxxx
switch:admin>
```

Note: If you are using the virtual fabric feature, you must run **configDownload -vf** before running the **configDownload** command in order to restore the logical switch configuration.

2. Enter the **chassisDisable** command.
3. Enter **configDownload -all** command.

```
switch:admin> configdownload -all
Server Name or IP Address [host]: 123.123.123.123
User Name [None]: Admin24
File Name [config.txt]: config-switch.txt
Password: xxxxxxxx
download complete
switch:admin>
```

4. Reboot the SAN384B-2.

Verifying correct operation of system

1. Log in to the SAN384B-2 as **admin**:

```
switch:admin> login
login: admin
password: xxxxxxxx
switch:admin>
```

2. Enter the **slotShow -m** command and verify that all the installed cards are detected and that their status is operational (enabled).

```
switch:admin> slotShow -m

Slot  Blade Type  ID  Model Name  Status
-----
1     SW BLADE  97  FC16-32  ENABLED
2     SW BLADE   77  FC8-64    ENABLED
3     CORE BLADE 46  CR16-4    ENABLED
4     CP BLADE  50  CP8       ENABLED
5     CP BLADE  50  CP8       ENABLED
6     CORE BLADE 46  CR16-4    ENABLED
7     SW BLADE  96  FC16-48  ENABLED
8     SW BLADE   77  FC8-64    ENABLED
switch:admin>
```

3. Verify that the system is functioning correctly by entering **switchShow** or **switchStatusShow**. The **switchShow** command displays the SAN384B-2 and port status information.

```
SAN384B-2_130:admin> switchshow
switchName: SAN384B-2_130
switchType: 121.3
switchState: Online
switchMode: Native
switchRole: Principal
switchDomain: 130
switchId: fffc82
switchWwn: 10:00:00:05:33:03:2c:00
zoning: ON (ZONE_CONFIG_NAME)
switchBeacon: OFF
FC Router: ON
FC Router BB Fabric ID: 10
Address Mode: 0
Index Slot Port Address Media Speed State Proto
=====
0     1     0    820000 id    N8    Online FC F-Port
10:00:00:05:1e:f8:a0:b4
1     1     1    820100 id    N8    Online FC F-Port
10:00:00:05:33:26:0e:65
2     1     2    820200 id    N8    Online FC F-Port
10:00:00:05:33:48:5e:f5
3     1     3    820300 id    N8    Online FC F-Port
10:00:00:05:1e:f8:a0:b3
<output truncated>
```

4. Verify that all the IP address information is correct by entering **ipAddrShow** and checking the results against the IP information recorded in the "config-miscinfo.txt" file.

```
switch:admin> ipaddrshow

SWITCH
Ethernet IP Address: xxx.xxx.xxx.12
Ethernet Subnetmask: 255.55.0.0
Fibre Channel IP Address: 1.2.3.4
Fibre Channel Subnetmask: 255.255.255.0

CP0
Ethernet IP Address: xxx.xxx.xxx.10
```

```
Ethernet Subnetmask: 255.55.0.0
HostName : cp0
Gateway Address: xxx.xxx.xxx.1
```

```
CP1
Ethernet IP Address: xxx.xxx.xxx.11
Ethernet Subnetmask: 255.55.0.0
HostName : cp1
Gateway Address: xxx.xxx.xxx.1
Backplane IP address of CP0 : 10.0.0.4
Backplane IP address of CP1 : 10.0.0.5
```

```
switch:admin>switch:admin>
```

Reconnecting the system to the network and fabric

See the cable routing and port connection information recorded previously in Table 17 on page 110 for the following steps.

To reconnect the system to the network and fabric, complete the following steps.

1. Connect the CP blades to the local area network:
 - a. Connect the appropriate Ethernet cables into each Ethernet port.
 - b. Connect the other ends to an Ethernet 10/100 Base-T LAN, if not already connected.

Note: The SAN384B-2 can be accessed by remote connection using any of the available management tools, such as Telnet or Web Tools. Ensure that the system is not modified using other connections during the rest of this procedure.

2. Reconnect the transceivers and cables to the port blades. See details in “Removing and installing transceivers” on page 89, particularly for differences between the SFP+ and mSFP installations.

Note: The ports and cables used in trunking groups must meet specific requirements. For a list of these requirements, refer to the *Fabric OS Administrator’s Guide*.

- a. Position one of the transceivers so that the key is oriented correctly to the port and insert the transceiver into the port until it is firmly seated and the latching mechanism clicks.

Note: For mSFPs in the FC8-64 high density port blades, connect the cables to the mSFPs first, then insert the entire cable-transceiver assembly into the port.

- b. Select the cable that corresponds to the port and position it so that the key (the ridge on one side of the cable connector) is aligned with the slot in the transceiver; then, insert the cable into the transceiver until the latching mechanism clicks.
- c. Repeat steps a and b for the remaining ports.

Attention: Do not route cables in front of the air exhaust vent (located on the upper and lower port side of the chassis).

- d. Organize the cables as required (see “Managing cables” on page 44).

Attention: Do not route cables in front of the air exhaust vents.

Verifying correct configuration of the fabric

Copying the command outputs from this section into a file is recommended.

1. Create an “after” SAN profile by entering the following commands and copying the output to a text file named “SANafter.txt”:

- **nsShow**
- **nsAllShow**
- **switchShow**
- **fabricShow**
- **lscfg --show** (if using the Virtual Fabric feature)

```
switch:admin> nsshow
Type Pid COS PortName NodeName TTL(sec)
N 020f00; 3;10:00:00:01:73:00:29:46;10:00:00:01:73:00:29:46; na
Fabric Port Name: 20:0f:00:60:69:90:03:f0
<output truncated>
```

```
switch:admin> nsallshow
{020f00 021fda 021fdc 021fe0 021fe15 Nx_Ports in the Fabric}
<output truncated>
```

```
switch:admin> switchshow
switchName: rsl8-st03-dcx-01
<output truncated>
```

```
switch:admin> fabricshow
Switch ID Worldwide Name Enet IP Addr FC IP Addr Name
<output truncated>
```

```
switch:admin> lscfg --show
Created switches: 128(ds) 1 2(bs)
Port 0 1 2 3 4 5 6 7 8 9
-----
FID 1 | 1 | 1 | 1 | 1 | 128 | 128 | 128 | 128 | 128 |
<output truncated>
```

```
switch:admin>
```

2. Determine any differences between the information in the “SANafter.txt” file and the information in the “SANbefor.txt” file created earlier. In particular, look for differences in the following:
 - Device types
 - Number of devices
 - ISL and port states
 - Number of switches in the fabric
3. Resolve any issues or unintentional changes to the SAN384B-2 or fabric.
 - If there are any mechanical problems, try reseating the associated component.
 - If the configuration information is not correct for the system, modify as required.
 - If other issues exist, contact IBM Support

Cable routing table template

Table 17 is a 64-port template for a cable-routing table. Expand or duplicate the table as needed, for the number of ports in the chassis.

Table 17. Cable routing table for SAN384B-2 (64 ports shown)

Slot/Port		Cable labels		Connected device	Slot/Port of device
Slot	Port	Switch end	Device end		
	0				
	1				
	2				
	3				
	4				
	5				
	6				
	7				
	8				
	9				
	10				
	11				
	12				
	13				
	14				
	15				
	16				
	17				
	18				
	19				
	20				
	21				
	22				
	23				
	24				
	25				
	26				
	27				
	28				
	29				
	30				
	31				
	32				
	33				
	34				
	35				

Table 17. Cable routing table for SAN384B-2 (64 ports shown) (continued)

Slot/Port		Cable labels		Connected device	Slot/Port of device
Slot	Port	Switch end	Device end		
	36				
	37				
	38				
	39				
	40				
	41				
	42				
	43				
	44				
	45				
	46				
	47				
	48				
	49				
	50				
	51				
	52				
	53				
	54				
	55				
	56				
	57				
	58				
	59				
	60				
	61				
	62				
	63				

Removing the batteries

Local regulations may require removal of the battery before recycling or disposing of the product. Batteries are located in the control processor blades (CP8) and also in optional Encryption blades (FS8-18). Follow these steps to remove the batteries from the product:

CAUTION:

The battery contains lithium. To avoid possible explosion, do not burn or charge the battery.

DO NOT:

- Throw or immerse into water
- Heat to more than 100°C (212°F)
- Repair or disassemble

Exchange only with the IBM-approved part. Recycle or discard the battery as instructed by local regulations. In the United States, IBM has a process for the collection of this battery. For information, call 1-800-426-4333. Have the IBM part number for the battery unit available when you call. (C003)

1. Remove any installed modules.
2. Remove any installed power supplies.
3. Unscrew fasteners and remove any fan trays or fan assemblies.
4. Unscrew fasteners, unplug all connectors and remove any Printed Circuit Board Assembly (PCBA) from the fan trays or fan assemblies.
5. In the two control processor blade (CP8) assemblies, locate the central processor PCBAs.
6. Go to the following locations and remove the two BR1225 batteries from each of the PCBAs (see **1** in Figure 50):
 - a. XB1
 - b. XB

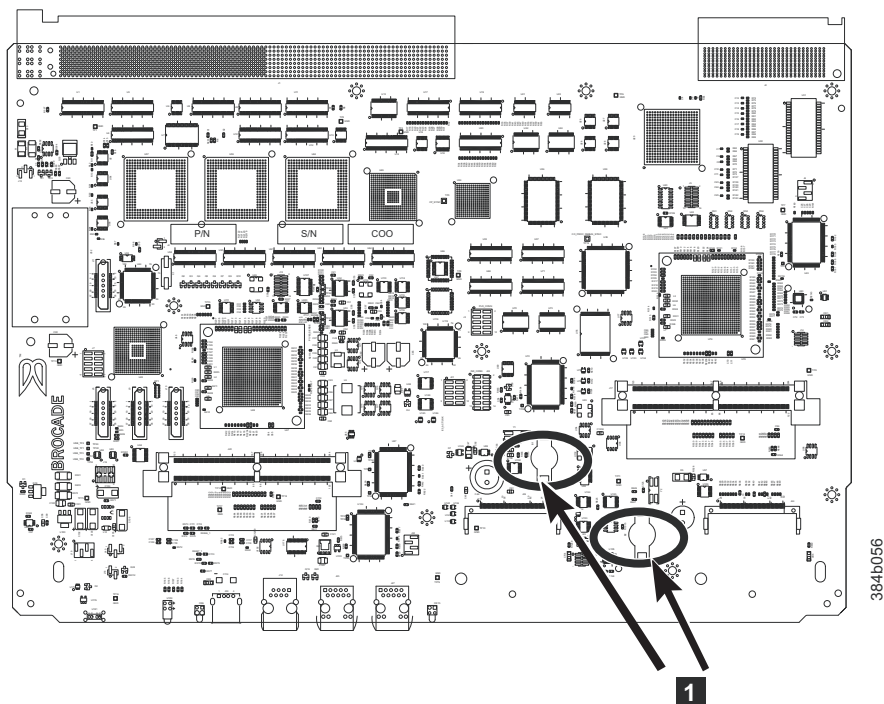

Figure 50. Battery locations on the CP8 blade

7. For the optional FS8-18 encryption blade, go to the BC1 location (see **1** in Figure 51 on page 113) on the main board and remove the BR1225 battery.

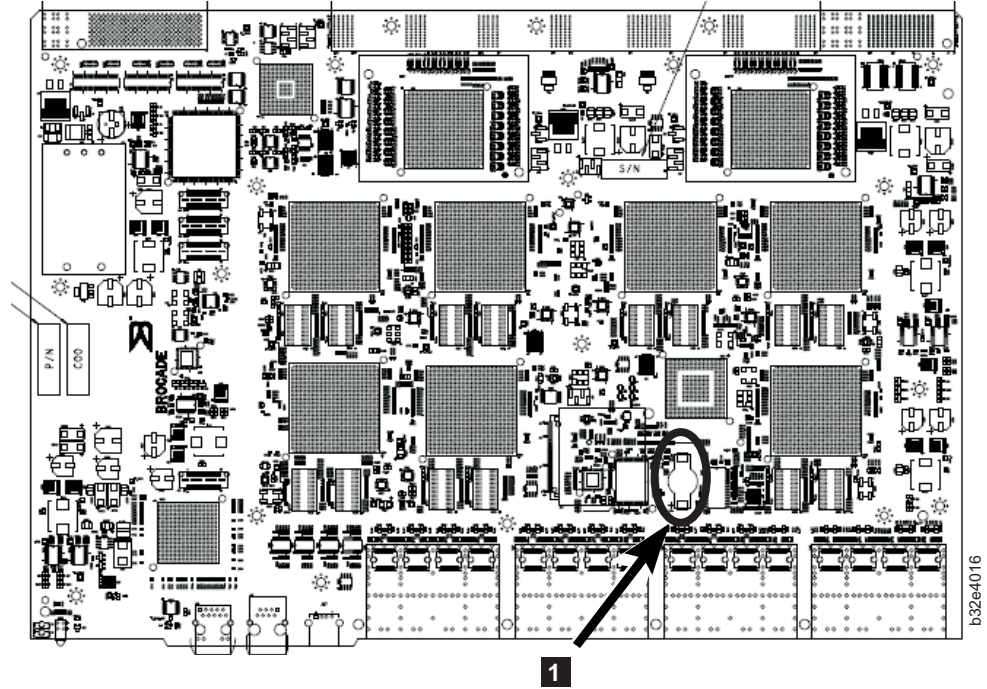

Figure 51. Encryption blade battery location

8. Recycle the batteries as appropriate.

Refer to the *Environmental Notices and User Guide* shipped with the product for more information on battery recycling and disposal.

Chapter 6. Installing new features

Attention: Refer to “Safety notices and labels” on page xv before performing any service or installation procedures.

The SAN384B-2 can be upgraded with any of the following hot-pluggable features while the SAN384B-2 is operational. Refer to the individual feature installation instructions for any possible exceptions.

Use this chapter as a starting point when installing new features on an existing SAN384B-2. Specific installation procedures are linked from each feature code installation on this page to the appropriate sections in the Chapter 5, “Removing and installing components,” on page 67 chapter.

- “FC3632, FC3648- Installing a 16-Gb port blade (32 or 48 ports)”
- “FC3633, FC3649- Installing an Enhanced 8-Gb port blade (32 or 48 ports)” on page 117
- “FC3864 - Installing an 8-Gb 64-port port blade” on page 118
- “FC3890 - Installing an 8 Gbps Extension Blade (FX8-24)” on page 120
- “FC3895 - Installing an Encryption Blade (FS8-18)” on page 121
- “FC7230 - Installing FIPS 140-2 Level 2 tamper proof seals” on page 123
- “FC7871 - Installing a QSFP and inter-chassis license” on page 123
- “FC7872 - Installing a QSFP and Enterprise inter-chassis license” on page 124

FC3632, FC3648- Installing a 16-Gb port blade (32 or 48 ports)

These features can be installed while the SAN384B-2 is operational.

Attention: Follow these precautions for all procedures in this section to avoid damaging the port blades or chassis:

- Wear a grounded ESD strap when handling a port blade (see “ESD precautions” on page xxi).
- Carefully remove the protective strip (if any) covering the blade connectors before installing any blades.
- Do not force the port blade installation. If the port blade does not slide in easily, ensure that it is correctly aligned inside the rail guides before continuing. Installing a port blade with incorrect alignment damages both the chassis and the replacement part.
- Hold the port blade by the edges of the metal pan. Do not use the ejectors to hold a port blade.
- Disassembling any part of a port blade voids the part warranty and regulatory certifications. There are no user-serviceable parts inside the port blade.

These instructions cover installing a new FC3632 or FC3648 in the SAN384B-2 chassis.

Time required

20 minutes or less per port blade.

Items required

- ESD (electrostatic discharge) grounding strap
- Workstation computer
- Port blade
- Phillips screwdriver
- SFP+ transceivers (as needed)
- Optical cables (as needed)

Procedures

Follow the links in the steps below to complete this installation:

1. Verify that the port blade is the correct part: 99Y0347 for the 32-port blade, and 99Y0350 for the 48-port blade.
2. Verify which slot to install the blade. Slots are numbered from one through eight, from bottom to top, when facing the port side of the SAN384B-2. Port blades can be installed in any of the slots 1, 2, 7, or 8.
3. We recommend having the latest firmware version on the CP blade. The firmware version should match on both the active and the backup CP blades. If the firmware is not at the latest level, obtain new code from the code download website, and install it prior to installing the port blade. See “Fabric OS firmware updates” on page 48 for instructions.

Note: Firmware downloads require that Ethernet connections be made to both CP blades. Procedures for downloading and installing firmware are described in the *Fabric OS Administrator’s Guide*.

4. Remove the filler panel or port blade. Refer to “Removing a port or application blade” on page 70 or “Removing and installing blade filler panels” on page 72.
Attention: A filler panel should be removed only when being replaced with a port blade or new filler panel. Any slot that is not occupied by a port blade should be occupied by a filler panel to ensure correct cooling of the chassis and protection from dust.
5. Follow the instructions for “Installing a blade” on page 72.
6. Follow the instructions for “Removing and installing transceivers” on page 89. Because of port density, it may be easier to remove and install the SFP+ transceivers while the 32-port or 48-port blade is out of the chassis. However, you must handle the blade carefully while it is out of the chassis to avoid damaging the blade and the transceivers.
7. Install, group, and route the cables as desired. See “Managing cables” on page 44 for additional cabling instructions.
Attention: Do not route cables in front of the exhaust vent, which is located at the top on the port side of the chassis.
8. Verify the installation. For information about how to check the status of hardware components using the CLI, see the *Fabric OS Administrator’s Guide*, which is located on the product documentation CD.

FC3633, FC3649- Installing an Enhanced 8-Gb port blade (32 or 48 ports)

These features can be installed while the SAN384B-2 is operational.

Note: A minimum level of FOS 7.0.1 is required for these blades.

Attention: Follow these precautions for all procedures in this section to avoid damaging the port blades or chassis:

- Wear a grounded ESD strap when handling a port blade (see “ESD precautions” on page xxi).
- Carefully remove the protective strip (if any) covering the blade connectors before installing any blades.
- Do not force the port blade installation. If the port blade does not slide in easily, ensure that it is correctly aligned inside the rail guides before continuing. Installing a port blade with incorrect alignment damages both the chassis and the replacement part.
- Hold the port blade by the edges of the metal pan. Do not use the ejectors to hold a port blade.
- Disassembling any part of a port blade voids the part warranty and regulatory certifications. There are no user-serviceable parts inside the port blade.

These instructions cover installing a new FC3633 or FC3649 in the SAN384B-2 chassis.

Time required

20 minutes or less per port blade.

Items required

- ESD (electrostatic discharge) grounding strap
- Workstation computer
- Port blade
- Phillips screwdriver
- SFP+ transceivers (as needed)
- Optical cables (as needed)

Procedures

Follow the links in the steps below to complete this installation:

1. Verify that the port blade is the correct part, 98Y2255 for the 32-port blade, and 982270 for the 48-port blade.
2. Verify which slot to install the blade. Slots are numbered from one through eight, from bottom to top, when facing the port side of the SAN384B-2. Port blades can be installed in any of the slots 1, 2, 7, or 8.
3. We recommend having the latest firmware version on the CP blade. A minimum level of FOS 7.0.1 is required for these blades. The firmware version should match on both the active and the backup CP blades. If the firmware is not at the latest level, obtain new code from the code download website, and install it prior to installing the port blade. See “Fabric OS firmware updates” on page 48 for instructions.

Note: Firmware downloads require that Ethernet connections be made to both CP blades. Procedures for downloading and installing firmware are described in the *Fabric OS Administrator's Guide*.

4. Remove the filler panel or port blade. Refer to "Removing a port or application blade" on page 70 or "Removing and installing blade filler panels" on page 72.
Attention: A filler panel should be removed only when being replaced with a port blade or new filler panel. Any slot that is not occupied by a port blade should be occupied by a filler panel to ensure correct cooling of the chassis and protection from dust.
5. Follow the instructions for "Installing a blade" on page 72.
6. Follow the instructions for "Removing and installing transceivers" on page 89. Because of port density, it may be easier to remove and install the SFP+ transceivers while the 32-port or 48-port blade is out of the chassis. However, you must handle the blade carefully while it is out of the chassis to avoid damaging the blade and the transceivers.
7. Install, group, and route the cables as desired. See "Managing cables" on page 44 for additional cabling instructions.
Attention: Do not route cables in front of the exhaust vent, which is located at the top on the port side of the chassis.
8. Verify the installation. For information about how to check the status of hardware components using the CLI, see the *Fabric OS Administrator's Guide*, which is located on the product documentation CD.

FC3864 - Installing an 8-Gb 64-port port blade

This feature can be installed while the SAN384B-2 is operational.

Attention: Follow these precautions for all procedures in this section to avoid damaging the port blades or chassis:

- Wear a grounded ESD strap when handling a port blade.
- Carefully remove the protective strip (if any) covering the blade connectors before installing any blades.
- Do not force the port blade installation. If the port blade does not slide in easily, ensure that it is correctly aligned inside the rail guides before continuing. Installing a port blade with incorrect alignment damages both the chassis and the replacement part.
- Hold the port blade by the edges of the metal pan. Do not use the ejectors to hold a port blade.
- Disassembling any part of a port blade voids the part warranty and regulatory certifications. There are no user-serviceable parts inside the port blade.

These instructions cover installing a new FC3864 in the SAN384B-2 chassis.

Time required

20 minutes or more per port blade due to port and cable density

Items required

- ESD (electrostatic discharge) grounding strap
- Workstation computer
- Port blade
- #2 Phillips screwdriver

- mSFP transceivers (as needed)
- OM-3 LC optical cables (as needed)

Procedures

Follow the links in the steps below to complete this installation:

1. Verify that the port blade is the correct part (45W7566)
2. Remove the chassis door. See “Removing and installing the chassis door” on page 67.
3. Verify which slot to install the blade. Slots are numbered from one through eight, from bottom to top, when facing the port side of the SAN384B-2s. Port blades can be installed in any of the slots 1, 2, 7, or 8.
4. We recommend having the latest firmware version on the CP blade. The firmware version should match on both the active and the backup CP blades. If the firmware is not at the latest level, obtain new code from the code download website, and install it prior to installing the port blade. See “Fabric OS firmware updates” on page 48 for instructions.

Note: Firmware downloads require that Ethernet connections be made to both CP blades. Procedures for downloading and installing firmware are described in the *Fabric OS Administrator’s Guide*.

5. Remove the filler panel or port blade. Refer to “Removing a port or application blade” on page 70 or “Removing and installing blade filler panels” on page 72.

Attention: A filler panel should be removed only when being replaced with a port blade or new filler panel. Any slot that is not occupied by a port blade should be occupied by a filler panel to ensure correct cooling of the chassis and protection from dust.

6. Follow the instructions for “Installing a blade” on page 72.
7. Remove any mSFPs that are pre-installed in the new FC8-64 blade and set them aside for later installation. See “Removing and installing an mSFP optical transceiver” on page 92, paying particular attention to the notices to avoid damaging the mSFP pull tabs or mSFPs.
8. Follow the instructions for “Installing a blade” on page 72.

Note: The FC8-64 high density port blade cannot use the standard LC cables because the pitch between optics in the mSFP transceiver is smaller than in standard SFPs. Patch cables and panels can be used to attach standard size cabling to the blade if necessary. Figure 16 on page 32 illustrates the mSFP to SFP patch cable. The mSFP transceivers are used only with the FC8-64 port blade. Narrower OM-3 LC cables are used to connect the FC8-64. These cables are offered by several major manufacturers. Contact your IBM representative for options regarding different cable and patch panel configurations to simplify cable management with higher density FC8-64 port blades.

9. Insert an OM-3 (narrow) cable into an mSFP, and then insert the mSFP/cable unit into a port. See “Removing and installing an mSFP optical transceiver” on page 92, paying particular attention to the notices to avoid damaging the mSFP pull tabs, mSFPs, and cables.
10. Repeat step 8 for each port in the FC8-64 blade, proceeding in a systematic manner to avoid tangling the cables.
11. Group and route the cables as desired. See “Managing cables” on page 44 for additional cabling instructions.

Attention: Do not route cables in front of the exhaust vent, which is located at the top on the port side of the chassis.

12. Verify the installation (see the appropriate section of Chapter 4, “Monitoring system components,” on page 51). For information about how to check the status of hardware components using the CLI, see the *Fabric OS Administrator’s Guide*, which is located on the product documentation CD.
13. Reinstall the chassis door. See “Removing and installing the chassis door” on page 67.

FC3890 - Installing an 8 Gbps Extension Blade (FX8-24)

This feature can be installed while the SAN384B-2 is operational.

Attention: Follow these precautions for all procedures in this section to avoid damaging the port blades or chassis:

- Wear a grounded ESD strap when handling a port blade (see “ESD precautions” on page xxi).
- Carefully remove the protective strip (if any) covering the blade connectors before installing any blades.
- Do not force the port blade installation. If the port blade does not slide in easily, ensure that it is correctly aligned inside the rail guides before continuing. Installing a port blade with incorrect alignment damages both the chassis and the replacement part.
- Hold the port blade by the edges of the metal pan. Do not use the ejectors to hold a port blade.
- Disassembling any part of a port blade voids the part warranty and regulatory certifications. There are no user-serviceable parts inside the port blade.

Time required

Less than 20 minutes.

Items required

- ESD (electrostatic discharge) grounding strap
- Workstation computer
- Port blade
- Phillips screwdriver
- Transceivers (as needed)
- Optical cables (as needed)

Procedures

Follow the links in the steps below to complete this installation.

1. Verify that the blade is the correct part.
2. Verify which slot to install the blade. Slots are numbered from one through eight, from bottom to top, when facing the port side of the SAN384B-2s. Port blades can be installed in any of the slots 1, 2, 7, or 8.
3. We recommend having the latest firmware version on the CP blade. The firmware version should match on both the active and the backup CP blades. If the firmware is not at the latest level, obtain new code from the code download website, and install it prior to installing the port blade. See “Fabric OS firmware updates” on page 48 for instructions.

Note: Firmware downloads require that Ethernet connections be made to both CP blades. Procedures for downloading and installing firmware are described in the *Fabric OS Administrator's Guide*.

4. Remove the filler panel or port blade. Refer to "Removing and installing port, application, and encryption blades" on page 70 and "Removing and installing blade filler panels" on page 72.

Attention: A filler panel should be removed only when being replaced with a port blade or new filler panel. Any slot that is not occupied by a port blade should be occupied by a filler panel to ensure correct cooling of the chassis and protection from dust.

5. Install the port blade ("Installing a blade" on page 72). Remove the protective strip from the blade contacts (if any) before installing the blade.
6. Repeat steps 1-5 for additional blades, if any.
7. Install the transceivers ("Removing and installing transceivers" on page 89), and confirm the proper operation of the blade.
8. Install, group, and route the cables as desired. See "Managing cables" on page 44 for additional cabling instructions.

Attention: Do not route cables in front of the exhaust vent, which is located at the top on the port side of the chassis.

9. Verify the installation. For information about how to check the status of hardware components using the CLI, see the *Fabric OS Administrator's Guide*, which is located on the product documentation CD.

FC3895 - Installing an Encryption Blade (FS8-18)

This feature can be installed while the SAN384B-2 is operational.

Attention: Thoroughly review "Planning for encryption (optional)" on page 45 prior to installing the FS8-18 encryption blade. You must also refer to the *Fabric OS Encryption Administrator's Guide Supporting Tivoli Key Lifecycle Manager (TKLM) Environments* to successfully complete installation, configuration, and management of the encryption functionality.

Attention: Follow these precautions for all procedures in this section to avoid damaging the port blades or chassis:

- Wear a grounded ESD strap when handling a port blade (see "ESD precautions" on page xxi).
- Carefully remove the protective strip (if any) covering the blade connectors before installing any blades.
- Do not force the port blade installation. If the port blade does not slide in easily, ensure that it is correctly aligned inside the rail guides before continuing. Installing a port blade with incorrect alignment damages both the chassis and the replacement part.
- Hold the port blade by the edges of the metal pan. Do not use the ejectors to hold a port blade.
- Disassembling any part of a port blade voids the part warranty and regulatory certifications. There are no user-serviceable parts inside the port blade.

Time required

Less than 20 minutes, not including configuration.

Items required

- ESD (electrostatic discharge) grounding strap
- Workstation computer
- Encryption blade
- Phillips screwdriver
- Transceivers (as needed)
- Optical cables (as needed)

Procedures

Follow the links in the steps below to complete this installation.

1. Verify that the blade is the correct part.
2. Verify which slot to install the blade. Slots are numbered from one through eight, from bottom to top, when facing the port side of the SAN384B-2s. Encryption blades can be installed in any of the slots 1, 2, 7, or 8. Up to four FS8-18 encryption blades can be installed in a single chassis.
3. We recommend having the latest firmware version on the CP blade. The firmware version should match on both the active and the backup CP blades. If the firmware is not at the latest level, obtain new code from the code download website, and install it prior to installing the port blade. See “Fabric OS firmware updates” on page 48 for instructions.

Note: Firmware downloads require that Ethernet connections be made to both CP blades. Procedures for downloading and installing firmware are described in the *Fabric OS Administrator’s Guide*.

4. Remove the filler panel or port blade. Refer to “Removing and installing port, application, and encryption blades” on page 70 and “Removing and installing blade filler panels” on page 72.
Attention: A filler panel should be removed only when being replaced with a blade or new filler panel. Any slot that is not occupied by a blade should be occupied by a filler panel to ensure correct cooling of the chassis and protection from dust.
5. Install the encryption blade (“Installing a blade” on page 72). Remove the protective strip from the blade contacts (if any) before installing the blade.
6. Repeat steps 1-5 for additional blades, if any.
7. Install the transceivers (“Removing and installing transceivers” on page 89), and confirm the proper operation of the blade.
8. Install, group, and route the cables as desired. See “Managing cables” on page 44 for additional cabling instructions.
Attention: Do not route cables in front of the exhaust vent, which is located at the top on the port side of the chassis.
9. Verify the installation. For information about how to check the status of hardware components using the CLI, see the *Fabric OS Administrator’s Guide*, which is located on the product documentation CD.
10. The FS8-18 encryption blade requires additional configuration to enable encryption. See “Configuring for encryption (optional)” on page 46 for an overview of those steps. Refer to the *Fabric OS Encryption Administrator’s Guide Supporting Tivoli Key Lifecycle Manager (TKLM) Environments* for more detailed information regarding encryption and TKLM key management.

Avoid double encryption

Encryption and decryption at the storage device level does not affect the encryption switch or blade capabilities, and does not cause problems with decrypting the data. However, double encryption adds the unnecessary need to manage two sets of encryption keys, increases the risk of losing data, may reduce performance, and does not add security.

FC7230 - Installing FIPS 140-2 Level 2 tamper proof seals

The majority of the seals in this feature can be installed while the SAN384B-2 is operational. However, there are several seals that may be difficult to apply to the chassis and port side exhaust kit if the chassis is already installed in a cabinet. Plan the installation of the chassis and other features accordingly. Refer to the separate publication, *IBM System Storage FIPS 140-2 Security Seal Application Procedures* (GA32-2220-00), for installation instructions of these seals for several different models. This publication is available through the IBM Support Portal www.ibm.com/supportportal and the IBM Publications Center www.ibm.com/shop/publications/order.

FC7871 - Installing a QSFP and inter-chassis license

This feature can be installed while the SAN384B-2 is operational.

Time required

Less than 10 minutes, not including installation of the ICL license or any needed configuration.

Items required

- QSFPs and four ICL cables
- FC 7871 (ICL license) is required for each chassis that you are connecting. Instructions for installation are included with that license feature.

Procedures

Attention: If ICL cables are not in use, rubber plugs must be inserted in the QSFPs.

Follow the links in the steps below to complete this installation.

1. Verify that the QSFP is the correct part: 99Y0377.
2. Verify with the customer that the ICL license is installed on each chassis to be connected. Enter the **licenseIdShow** command for each chassis. If required, install the ICL license, following the instructions included with the license.
3. Remove the chassis door (“Removing and installing the chassis door” on page 67).
4. Determine the cable routing and QSFP ports on the core switch blades that you will be using to connect the two chassis.
5. Remove the rubber plugs from the QSFP ports on the core blades that you will be connecting. Save the plugs for possible future use.
6. Install the two QSFPs and ICL cables (“Removing and replacing inter-chassis link (QSFP) cables” on page 93).
7. Install the chassis door (“Removing and installing the chassis door” on page 67).

8. Enable the inter-chassis links. See the **iclCfg** section in the *Fabric OS Command Reference Manual* for CLI command options.
9. Verify the operation of the ICL (see Table 15 on page 93).

FC7872 - Installing a QSFP and Enterprise inter-chassis license

This feature can be used to connect up to nine 2499 fabric backbone chassis and can be installed while the SAN384B-2 is operational.

Time required

Depending on the complexity of the ICL configuration, installation can take from 20-60 minutes, not including installation of the ICL license or any needed configuration. Sample configurations are shown in “Possible ICL configurations” on page 95.

Items required

- QSFPs and four ICL cables for each chassis connection
- FC 7872 (ICL license for the 2499-416) or FC 7873 (ICL license for the 2499-816) is required for each chassis that you are connecting. Instructions for installation are included with that license feature.

Procedures

Attention: If ICL cables are not in use, rubber plugs must be inserted in the QSFPs.

Follow the links in the steps below to complete this installation.

1. Verify that the QSFP is the correct part: 99Y0377.
2. Verify with the customer that the ICL license is installed on each chassis to be connected. Enter the **licenseIdShow** command for each chassis. If required, install the ICL license, following the instructions included with the license.
3. Remove the chassis door (“Removing and installing the chassis door” on page 67).
4. Determine the cable routing and QSFP ports on the core switch blades that you will be using to connect the two chassis.
5. Remove the rubber plugs from the QSFP ports on the core blades that you will be connecting. Save the plugs for possible future use.
6. Install the two QSFPs and ICL cables (“Removing and replacing inter-chassis link (QSFP) cables” on page 93).
7. Install the chassis door (“Removing and installing the chassis door” on page 67).
8. Enable the inter-chassis links. See the **iclCfg** section in the *Fabric OS Command Reference Manual* for CLI command options.
9. Verify the operation of the ICL (see Table 15 on page 93).

Appendix A. Product specifications

This appendix provides product specifications for the SAN384B-2.

- “General specifications”
- “System architecture”
- “System size and weights” on page 127
- “Facility requirements” on page 128
- “Environmental requirements” on page 129
- “Fibre Channel port specifications” on page 129
- “Power specifications” on page 130
- “Data transmission ranges” on page 132
- “Power cords” on page 132

General specifications

The SAN384B-2 general specifications are listed in Table 18.

Table 18. General product specifications

Specification	Description
Configurable port types	F_Port, E_Port, EX_Port, M_Port, D_Port
System architecture	Nonblocking shared memory
System processor	FreeScale 8548, 1.2 GHz
ANSI Fibre Channel protocol	FC-PH (Fibre Channel Physical and Signalling Interface standard)
Modes of operation	Class 2, Class 3, Class F (interswitch frames)
Fabric initialization	Complies with FC-SW 5.0
FC-IP (IP over Fibre Channel)	Complies with FC-IP 2.3 of the FCA profile
Port to port latency	Local switching - 800ns (add 400ns for E_Port to E_Port); Blade to blade - 2.4 microseconds (add 400ns for E_Port to E_Port)
Switching capacity	An aggregate switching capacity of 3.36 billion frames per second (for Class 2, Class 3, and Class F frames for a 192 port chassis)

System architecture

Table 19 lists the system architecture for the SAN384B-2.

Table 19. System architecture

Fibre Channel Ports	Up to 192 16 Gbps ports, universal (E_Port, F_Port, EX_Port, M_Port, D_Port).
Control Processor	Redundant (active/standby) control processor blades
Scalability	Full fabric architecture: 239 switches maximum

Table 19. System architecture (continued)

Performance	<p>2.125 Gbps line speed, full duplex. 4.25 Gbps line speed, full duplex. 8.50 Gbps line speed, full duplex. 10.51875 Gbps line speed, full duplex. 16.0 Gbps line speed, full duplex. Autosensing of 2, 4, 8, and 16 Gbps port speeds depending on SFPs used. Speed matching between 2, 4, 8, and 16 Gbps port speeds. 10 Gbps port speeds with dedicated SFPs.</p>
ISL Trunking	<p>Automatically uses up to 4 ports in a trunk group to form a 32 Gbps trunk. Can use up to 8 ports in a trunk group to form a 64 Gbps trunk.</p>
Aggregate bandwidth	<p>4.1 Tbps when populated with four FC16-48 port blades and using 16 ICL ports @ 64 Gbps).</p>
Switch latency	<p>FC8-64 blades: <2.1 msec any port to any port at 8 Gbps, cut-through routing. FC8-32E blade: <800 ns any port to any port, 2.4 msec blade to blade at 8 Gbps, cut-through routing. FC8-48E blade: <800 ns any port to any port, 2.4 msec blade to blade at 8 Gbps, cut-through routing. FC16-32 blade: <800 ns any port to any port, 2.4 msec blade to blade at 16 Gbps, cut-through routing. FC16-48 blade: <800 ns any port to any port, 2.4 msec blade to blade at 16 Gbps, cut-through routing. FX8-24 blade - FC to FC: <2.1 msec any port to any port at 8 Gbps, cut-through routing.</p>
Maximum frame size	<p>2112-byte payload</p>
Frame buffers	<p>8000 per ASIC, with 5000 more that can be borrowed from neighboring ASIC if enabled.</p>
Port types	<p>FC8-64 supports these port types: F_Port, FL_Port, E_Port, Ex_Port, and M_Port. FC8-32E supports these port types: F_Port, E_Port, Ex_Port, and M_Port. FC8-48E supports these port types: F_Port, E_Port, Ex_Port, and M_Port. FC16-32 supports these port types: F_Port, E_Port, Ex_Port, M_Port, and D_Port. FC16-48 supports these port types: F_Port, E_Port, Ex_Port, M_Port, and D_Port. FS8-18 supports these port types: F_Port, FL_Port, E_Port, Ex_Port, and M_Port FX8-24 supports these port types: F_Port, FL_Port, E_Port, and Ex_Port on FC; VE_Port on GbE Note: Self-discovery is based on switch type (U_Port) with an optional port type control.</p>
Data traffic types	<p>Fabric switches supporting unicast, multicast (255 groups), and broadcast</p>

Table 19. System architecture (continued)

Media types	<p>Note: Brocade-branded SFP+ and mSFPs are required on this product. For a listing of transceivers compatible with this product:</p> <ul style="list-style-type: none"> • Go to the IBM SAN web page www.ibm.com/systems/storage/san • Select the SAN384B-2 product link • On the SAN384B-2 product page, click the Interoperability Matrix link. • In the Interoperability matrix, click the Transceivers link.
Fabric services	Advanced Performance Monitoring; Adaptive Networking (Ingress Rate Limiting, Traffic Isolation, QoS); BB credit recovery; Advanced Zoning (default zoning, port/WWN zoning, broadcast zoning); Dynamic Path Selection (DPS); End-to-End Performance monitoring; Extended Fabrics; Fabric Watch; FDMI; FICON CUP; Frame Redirection; FSPF; Integrated Routing; IPFC; ISL Trunking; Management Server; N_Port Trunking; NPIV; NTP v3; Port Fencing; Registered State Change Notification (RSCN); Reliable Commit Service (RCS); Simple Name Server (SNS); syslog; Top Talkers; Virtual Fabrics (Logical Switch, Logical Fabric)
Inter-chassis link (ICL/QSFP)	Chassis-to-chassis linkage through connectors on the core switch blade (CR16-4).

System size and weights

The weight of the SAN384B-2 can vary considerably depending on the combination of blades installed. Use Table 20 and Table 21 on page 128 to determine the weight of the system with your combination of port and application blades.

Table 20. System sizes and weights

System specification	Size and weight
Width	43.74 cm (17.22 in.)
Height	35.6 cm (14 in., 8U); 40 cm (15.75 in., 9U) with the port-side exhaust kit
Depth (without door)	61.29 cm (24.13 in.)
Depth (with door)	73.20 cm (28.82 in.)
SAN384B-2: 192-port configuration with four FC16-48 port blades including two CP blades, 2 core switch blades, two blowers, two power supplies, and two cable management finger assemblies	68 kg (150 lb.)

Table 20. System sizes and weights (continued)

System specification	Size and weight
Empty chassis: <ul style="list-style-type: none"> • No blades • No CPs • No CRs • No power supplies • No fan assemblies • No cable management devices 	25.4 kg (56 lb.)

System blade and FRU weights

Table 21 lists the weights of the compatible blades and other FRUs.

Table 21. System FRU weights

FRU	Weight
CP blade (CP8)	3.0 kg (6.6 lb.)
CR blade (CR16-4)	3.3 kg (7.3 lb.)
FC8-32E port blade	2.8 kg (6.2 lb) without media
FC8-48E port blade	3.3 kg (7.3 lb) without media
FC8-64 port blade	3.36 kg (7.4 lb.) without media
FC16-32 port blade	2.8 kg (6.2 lb.) without media
FC16-48 port blade	3.3 kg (7.3 lb.) without media
FS8-18 encryption blade	5.5 kg (12.0 lb) without media
FX8-24 extension blade	4.2 kg (9.2 lb) without media
Port card filler panel	1.5 kg (3.2 lb)
Power supply	2.45 kg (5.4 lb)
Blower assembly	5.73 kg (12.6 lb)
WWN bezel and cards	0.3 kg (0.6 lb)
Cable management assembly (2)	0.45 kg (1.0 lb.)
Chassis door	2.09 kg (4.6 lb.)

Facility requirements

The facility where the SAN384B-2 is in use must meet the following requirements to provide for correct operation:

- Adequate supply circuit, line fusing, and wire size, as specified by the electrical rating on the chassis nameplate
- The power specifications listed in Table 23 on page 130
- The environmental specifications listed in Table 22 on page 129
- If the SAN384B-2 will be installed in an EIA rack, ensure the following:
 - All equipment installed in the rack has a reliable branch circuit ground connection, and does not rely on a connection to a branch circuit, such as a power strip.
 - The rack is balanced and mechanically secured to provide stability in the event of an earthquake.

- Additional equipment does not exceed the rack's weight limits.

Environmental requirements

Table 22 lists the environmental operating ranges for the SAN384B-2. The requirements for non-operating conditions are also provided for acceptable storage and transportation environments.

CAUTION:

For CA residents only: IBM recommends installing this product in a room size of 2190 cubic feet (62 cubic meters) or larger at 0.4 ACH ventilation rate to reduce the concentrations of any chemicals emitted by the product.

Table 22. Environmental requirements

Condition	Acceptable range during operation	Acceptable range during nonoperation
Ambient temperature	0° to 40° C outside switch (32° to 104° F)	-25° to +70° C outside switch (-13° to 158° F)
Humidity	5% to 85% RH noncondensing, at 40° Celsius, with maximum gradient of 10% per hour	10% to 90% RH noncondensing, at 70° Celsius
Altitude	Up to 3 km (10,000 ft.) above sea level	0 to 12 km (40,000 ft.) above sea level
Shock	20G, 6ms duration, half-sine wave	33G, 11ms duration, half-sine wave
Vibration	0.5G p-p, 5-500 Hz at 1.0 octave/minute	2.0G p-p, 5-500 Hz at 1.0 octave/minute
Air flow	425 cu m/hr (250 cu ft/min)	None required
Heat dissipation (fully loaded with QSFPs)	1195 Watts or 4078 BTU/hr (192 port configuration)	Not applicable.

Note: The 0° to 40° Celsius range applies to the ambient air temperature at the air intake vents on the nonport side of the SAN384B-2. The temperature inside the SAN384B-2 can be up to 75° Celsius during SAN384B-2 operation. If the internal temperature range exceeds the operating ranges of the components, the LEDs, error messages, and Fabric Watch alerts will indicate a problem. Use the **tempShow** command or Fabric Watch commands to view temperature status.

Fibre Channel port specifications

The Fibre Channel ports in the SAN384B-2 support full duplex link speeds at 2, 4, 8, 10, or 16 Gbps inbound and outbound, automatically negotiating to the highest common speed of all devices connected to the port.

The ports are compatible with optical SWL (short wavelength: approximately 850 nm), and optical LWL (long wavelength: approximately 1310 nm) SFP+s and mSFPs (FC8-64 only). The strength of the signal is determined by the type of SFP+ or mSFP. The mSFPs support only SWL.

QSFP ports are fixed speed 16 Gbps ports designed to be used with specialized quad (4x16) connections and cables. They support only SWL.

The ports are universal and self-configuring, capable of becoming F_Ports (fabric ports), FL_Ports (fabric loop enabled), or E_Ports (expansion ports).

The ports meet all required safety standards.

Power specifications

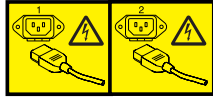

DANGER

Multiple power cords. The product might be equipped with multiple power cords. To remove all hazardous voltages, disconnect all power cords. (L003)

The power subsystem is a redundant +48V DC power distribution system with a provision for up to two 2000-watt, 48V DC bulk power supplies. Two bulk power supplies produce the intermediate distribution voltage in the distributed power system.

The power specifications listed in Table 23 are calculated for fully-loaded systems with two power supplies, four FC8-64 port blades, two CP8 blades, two CR16-4 blades with sixteen 64 Gbps QSFPs, and two blower assemblies. The use of application blades and/or encryption blades will consume additional power.

Table 23. Power specifications

Specification	Value
Input voltage	Range: 85-264 VAC Auto-volt, Nominal: 100-240 VAC.
Input frequency	Range: 47-63 Hz; Nominal: 50 - 60 Hz
Inrush current	Limited to 60A peak for any initial current surge or spike of 10ms or less at either cold or warm start . Any additional inrush current surges or spikes in the form of AC cycles or multiple AC cycles greater than 10ms, and less than 150ms, must not exceed 15A peak.
Power supply output (each)	Low line (85- 132 VAC), 1000W; High line (180 - 264 VAC), 2000W
System power consumption	AC power consumption is configuration specific. A system as described above consumes 1064W.

The power requirements for a given configuration depend on which blades have been installed in the chassis. Table 24 on page 131 shows the power draw for the blades that can be used in the SAN384B-2 chassis along with the power draw for the cooling fans. All numbers for the blades assume that the blade is fully populated with optical transceivers, including QSFPs for the core blades. All ports are Fibre Channel except where noted. You can calculate your power requirements by combining the power draws for the various blades and fan units in your configuration. While you may use fewer ports in a given blade, it is always safer to use the power requirement of a fully populated blade.

Table 24. Power demands per component

Blade or fan units	Maximum power draw (Watts)	Type of blade	Ports per blade	Number of blades permitted in chassis	Total ports per chassis
CP8	40	Control blade	NA	2	NA
CR16-4	240	Core blade	8 64 Gbps QSFP ports	2	16 quad ports (64 ports)
FC8-32E (8Gb)	140	Port blade	32 8 Gbps SFP+	up to 4	128
FC8-48E (8Gb)	160.4	Port blade	48 8 Gbps SFP+	up to 4	192
FC16-32 (16Gb)	140	Port blade	32 16 Gbps SFP+ (can use 8 Gbps SFP+)	up to 4	128
FC16-48 (16Gb)	160.4	Port blade	48 16 Gbps SFP+ (can use 8 Gbps SFP+)	up to 4	192
FC8-64 (8Gb)	126.4	Port blade	64 8Gbps SFP+	up to 4	256
FS8-18	235	Encryption blade	16 8 Gbps SFP+	up to 4	64
FX8-24	250	Extension blade	12 8 Gbps SFP+ 10 1 Gbps Ethernet 2 10 Gbps Ethernet	up to 4	48 8 Gbps 40 1 Gbps Ethernet 8 10 Gbps Ethernet
Fan unit	90	NA	NA	2 fans per chassis	NA

Data transmission ranges

Table 25 provides the data transmission ranges for different cable types and port speeds.

Note: There is no LWL or ELWL version of the mSFP or QSFP transceiver.

Table 25. Supported optics, speeds, cables, and distances

Transceiver type	Form factor	Speed	Multi-Mode Media Maximum Distance				Single Mode Media Maximum Distance
			62.5 microns (OM1)	50 microns (OM2)	50 microns (OM3)	50 microns (OM4)	9 microns
SWL	mSFP/SFP+	2 Gbps	150 m (492 ft.)	300 m (984 ft.)	500 m (1640 ft.)	N/A	N/A
	mSFP/SFP+	4 Gbps	70 m (229 ft.)	150 m (492 ft.)	380 m (1264 ft.)	400 m (1312 ft.)	N/A
	mSFP/SFP+	8 Gbps	21 m (68 ft.)	50 m (164 ft.)	150 m (492 ft.)	190 m (623 ft.)	N/A
	SFP+	10 Gbps	33 m (108 ft.)	82 m (269 ft.)	300 m (984 ft.)	550 m (1804 ft.)	N/A
	mSFP/SFP+	16 Gbps	15 m (49 ft.)	35 m (115 ft.)	100 m (328 ft.)	125 m (410 ft.)	N/A
	QSFP	4 x 16 Gbps	N/A	50 m (164 ft.)	N/A	N/A	N/A
LWL	SFP+	8 Gbps	N/A	N/A	N/A	N/A	10 km (6.2 mi.)
	SFP+	10 Gbps	N/A	N/A	N/A	N/A	10 km (6.2 mi)
	SFP+	16 Gbps	N/A	N/A	N/A	N/A	10 km (6.2 mi)
ELW	SFP+	2 Gbps	N/A	N/A	N/A	N/A	30 km (18.6 mi)
	SFP+	4 Gbps	N/A	N/A	N/A	N/A	30 km (18.6 mi)
	SFP+	8 Gbps	N/A	N/A	N/A	N/A	25 km (15.53 mi)

Greater distances can be achieved with the addition of the optional Extended Fabrics software.

Power cords

Two power cords for connecting between the SAN384B-2 and the power distribution units on the 2109 C36 cabinet are shipped with the product. See the *IBM TotalStorage SAN Cabinet 2109 Model C36 Installation and Service Guide* for information on connecting the cabinet to the facility power source. If the stand-alone feature is ordered for the SAN384B-2, then you must also order the country-specific power cords.

Appendix B. Application and encryption blades

This appendix contains specification information about optional application and encryption blades.

FS8-18 blade

The FS8-18 encryption blade is a high performance 16 port auto-sensing blade with data cryptographic (encryption/decryption) and data compression capabilities designed for enterprises to secure their data against theft or unauthorized use and to compress tape data for maximum utilization of tape media. The encryption blade is a network-based solution that secures data-at-rest for heterogeneous tape drives, disk array LUNs, and virtual tape libraries.

The FS8-18 blade provides the following major features:

- 16 auto-sensing F, FL, E, EX, and M ports at 8 Gbps FC ports
- 16 SFP media interfaces
- Encryption engines
- Key management/generation
- Key management with these hardware interfaces:
 - Two 1000Base copper type media interfaces
 - One smart card interface
- Security supervisor tamper detection and response capability
- CC (Common Criteria) EAL-3 compliant

FX8-24 blade

The FX8-24 blade has 12 external Fibre Channel (FC) SFP ports supporting the Fibre Channel Routing Services and 10 external 1 Gigabit Ethernet (GbE or GE) SFP ports supporting the Fibre Channel Over IP (FCIP) feature. There are also 2 licensable external 10 Gigabit Ethernet (10GbE or 10GE) SFP ports supporting FCIP. It operates with the Fabric Operating System and can communicate with another FX8-24 or a SAN06B-R for both Fibre Channel Routing Services and FCIP. The GbE ports on the FX8-24 are *not* compatible with the GbE ports on the FR4-18i blade or the SAN04B-R switch.

Note: The port diagram on the front panel of the blade uses the abbreviations GE for 1 GbE and 10GE for 10 GbE ports.

Attention: The 10 GbE SFPs used in the FX8-24 blade and the 10 Gbps FC SFPs used in the FC16-32 and FC16-48 blades are **NOT** interchangeable.

The FX8-24 operates in one of three modes: 1) ten 1 GbE ports, 2) ten 1GbE ports and one 10 GbE port, or 3) two 10 GbE ports depending on licensing and subsequent configuration of GbE port mode. If operating in 10GbE mode the other end of the circuit must also be an FX8-24 operating in either 10GbE mode or dual mode with the corresponding VE_ports in 10GbE mode.

The FX8-24 blade is intended as a platform for FCIP and Fibre Channel Routing Services. Refer to the *Fabric OS Administrator's Guide* for information on configuring these features. The FX8-24 blade provides the following hardware features:

- 12 autosensing FC ports with link speeds of 1, 2, 4 or 8 Gbps
- Ten GbE ports supporting FCIP with fixed link speed at 1 Gbps
- Two 10 GbE ports (licensable) supporting FCIP with fixed link speed at 10 Gbps

The FX8-24 blade also provides the following functionality features:

- FCIP
- Compression (on FC frames before FCIP encapsulation)
- FC Routing (licensable)
- FCIP Trunking (licensable) with network-based failure recovery (failover only) and load balancing
- Multiple circuits per trunk
 - Four per trunk through the GbE ports
 - Ten per trunk through the 10 GbE ports
- SO-TCP with reorder resistance
- FastWrite over FCIP
- Tape pipelining over FCIP
- FICON XRC emulation and tape pipelining over FCIP (licensable)
- FICON with CUP Activation (licensable)
- Virtual E_ports
- FCIP QoS
- Support for 200 ms RTT (on a limited number of GbE ports)
- Adaptive Rate Limiting (licensable)
- TCP performance graphing in Web Tools
- FCIP Tunnels
 - A maximum of 10 FCIP Tunnels for all GbE ports
 - Four tunnels maximum per GbE port
 - Two 10 GbE ports can support up to ten FCIP tunnels each
 - Each FCIP tunnel is represented and managed as a virtual Fibre Channel E_Port
 - Fibre Channel Routing Services can be used over the FCIP link
 - Fabrics connected through FCIP merge if the ports are configured as VE_Ports, and do not merge if they are configured as VEX_Ports. If VE_Ports are used in a Fibre Channel Routing Services backbone fabric configuration, then the backbone fabric merges, but the EX_Port-attached edge fabrics do not merge. For more information refer to the *Fabric OS Administrator's Guide*.
- Up to three FC trunking groups. The three groups are defined as:
 - Trunk group 0: FC ports 0, 1
 - Trunk group 1: FC ports 6, 7
 - Trunk group 2: FC ports 2, 3, 4, 5, 8, 9, 10, 11

Appendix C. Diagnostics and troubleshooting

For information about troubleshooting the entire fabric, refer to the *Fabric OS Troubleshooting and Diagnostics Guide*.

The SAN384B-2 includes a number of diagnostic tools to assist with troubleshooting, including LEDs on the hardware, commands that display current status, diagnostic tests for hardware and software, and error messages. In addition, a number of managing and monitoring features are available, such as Fabric Manager, Web Tools, Fabric Watch, and Advanced Performance Monitoring.

If the SAN384B-2 does not operate as expected, the following steps can be taken to diagnose the problem:

- Check the LEDs and refer to the LED tables (see Chapter 4, “Monitoring system components,” on page 51) for interpretation and recommended actions.
- Review the results of the last POST run by the SAN384B-2 (see “Interpreting POST and boot results” on page 136).
- Review the error logs (refer to the *Fabric OS Message Reference* and the *Fabric OS Administrator’s Guide* for more information).
- Review RASlog entries.
- Enter the **sensorShow** command to determine the status of the hardware components.
- Run diagnostic tests (see “Diagnostics” on page 137).
- Reboot the SAN384B-2 or power the entire chassis off (“Powering off the SAN384B-2” on page 49 and then back on (“Providing power to the SAN384B-2” on page 35).

If the problem is still unresolved after these steps, contact IBM support. The information required by technical support in order to provide assistance is listed under “Getting help” on page iii

This appendix provides the following information:

- “Obtaining chassis and component status”
- “Interpreting POST and boot results” on page 136
- “Diagnostics” on page 137
- “Troubleshooting” on page 137

Obtaining chassis and component status

The CLI commands listed in Table 26 on page 136 provide status and environmental information about the chassis and its components. These commands provide information only, and they do not interrupt traffic flow. For more information about these commands, refer to the *Fabric OS Command Reference*.

Table 26. Environmental status and maintenance commands

Command	Information Displayed
sensorShow	Temperature readings for the port blades
	Temperature readings for the CP blades
	Status and RPM of all operational fans
	Status of all operational power supplies
tempShow	Temperature readings for the port blades
	Temperature readings for the CP blades
psShow	Status of all operational power supplies
fanShow	Status and RPM of all operational fans
chassisShow	Serial number, time awake, and additional information about each component
slotShow	Slot occupancy
errShow, errDump	System error log. Refer to the <i>Fabric OS Message Reference</i> for more information on the messages in this log.

Interpreting POST and boot results

The SAN384B-2 performs power on self test (POST) by default each time the system is powered on, rebooted, or reset. The system can be rebooted using the **reboot** (to reboot each CP individually), or **fastBoot** commands. The **fastBoot** command reboots the SAN384B-2 without running POST. If the active CP blade is rebooted, it fails over to the standby CP blade.

POST

To verify that POST has completed without error:

- Verify that all LEDs return to a normal state after POST completes (see Chapter 4, “Monitoring system components,” on page 51).
If one or more LEDs do not return to a normal state, and this is not due to the SAN384B-2 being set to beacon, refer to the relevant LED table to identify and correct the problem. For port blades, router blades, and CP blades, the **slotShow** command can be used to check the status of the slots. For information about turning beaconing on/off, refer to the *Fabric OS Administrator’s Guide*.
- Verify that the switch prompt displays when POST completes.
If it does not display, POST was not successfully completed. Contact IBM for support.
- Review the system error log using the **errShow** or **errDump** commands.
- Any errors detected during POST are written to the system log, which is accessible through the **errShow** command. For information about error messages, refer to the *Fabric OS Message Reference*.

POST includes the following steps:

1. Preliminary POST diagnostics are run.
2. Operating system is initialized.
3. Hardware is initialized.

4. Diagnostic tests are run on several functions, including circuitry, port functionality, ability to send and receive frames, all aspects of memory, parity, statistics counters, and serialization.

Boot

In addition to POST, boot includes the following steps after POST is complete:

1. Universal port configuration is performed.
2. Links are initialized.
3. Fabric is analyzed. If any ports are connected to other switches, the SAN384B-2 participates in a fabric configuration.
4. The SAN384B-2 obtains a domain ID and assigns port addresses.
5. Unicast routing tables are constructed.
6. Normal port operation is enabled.

Diagnostics

Diagnostic tests are automatically run during POST to check the status of the SAN384B-2. Any error messages generated during POST are sent to the error logs and to the serial console, if connected.

Diagnostic tests can also be run manually to test and troubleshoot the hardware and the firmware, including internal connections and circuitry, transceivers, and port cables. However, diagnostic tests are generally intended for use by support personnel.

Note: Error messages do not necessarily indicate that the SAN384B-2 requires maintenance.

Each diagnostic test can be implemented by entering the related command through a Telnet or serial session. For a list of diagnostic tests and commands, refer to the *Fabric OS Command Reference Manual* and the *Fabric OS Administrator's Guide*.

All diagnostic tests are run at all supported link speeds. They might temporarily lock the transmit and receive speeds to a specific speed. Some diagnostic tests require interconnecting the ports to each other or using loopback plugs. If ports are interconnected, the media (cables and transceivers) at each end of the connection must be of the same type. For example, short wavelength media must be connected to short wavelength media, and likewise with long wavelength media and copper media.

For more information about diagnostic tests and how to run them, refer to the *Fabric OS Administrator's Guide* and the *Fabric OS Command Reference Manual*. For information about diagnostic error messages (**errShow** or **errDump**), refer to the *Fabric OS Message Reference*.

Troubleshooting

Table 27 provides a list of issues, possible causes, and recommended actions.

Table 27. Troubleshooting

Issue	Possible Cause	Recommended Action
Entire chassis powers off automatically.	Power supplies are inadequate to support the installed components.	Add an additional power supply.

Table 27. Troubleshooting (continued)

Several or all components are not operating.	One or both power cables may not be connected to a live source.	Ensure that both power cables are connected to live outlets.
	One or both AC power switches might be off.	Ensure that both AC power switches are on (AC switches light up green when on).
Serial connection is faulty or serial port logs have incorrect or missing information.	Serial cable is not connected correctly.	Ensure that the cable is firmly connected to workstation computer and to the SAN384B-2.
	Terminal emulator application parameters are not set correctly.	Ensure that the terminal emulator application is configured as follows: 9600 bits per second, 8 databits, no parity, 1 stop bit, no flow control.
	Serial port might be incompatible (only RS-232 is supported).	Ensure that the SAN384B-2 is connected to an RS-232 port. RS-423 serial ports might experience difficulties due to corner-case incompatibilities of the standards.
	Pins on the serial cable or serial port might be damaged.	Remove the cable and inspect the pins on the cable and in the serial port. Do not reinstall if the pins on either component have any visible damage, as this could damage the pins on the other component. Replace components as required.
CP Ethernet link speed is different than expected or a link cannot be established.	There might be a conflict with the CP Ethernet link speed negotiation set up by the network.	Specify the CP Ethernet link speed by entering the ifModeSet command.
Configuration data is inaccurate or cannot be accessed.	The SAN384B-2 was powered off/on while a WWN card was uninstalled or failed.	Install an operational WWN card and power the system off/on again.
	The SAN384B-2 was rebooted while a WWN card was uninstalled or failed.	
Initial set up results in IP address/Domain ID conflict.	The SAN384B-2 was connected to the fabric before being configured.	Refer to Chapter 3, "Starting and configuring the SAN384B-2," on page 33 and the <i>Fabric OS Administrator's Guide</i> for configuration information.
LEDs on one or more components are changing rapidly or do not indicate a healthy state.	The SAN384B-2 might be booting or running POST.	Verify that boot and POST are complete. The SAN384B-2 requires a minimum of 3 minutes, usually, after power-on to complete POST.
	Beaconing might be on for the entire SAN384B-2 or for individual components.	Determine whether beaconing is on by entering the switchShow command and determine whether switch beaconing or blade beaconing are on.
	Individual components might have failed.	Refer to the LED tables in Chapter 4, "Monitoring system components," on page 51 for interpretation and recommended actions.
	Pins on the components might be damaged.	Remove the component from the chassis and inspect the pins on the component and inside the chassis. Do not reinstall if pins on either component are visibly damaged, as this could damage pins on other component. Replace the parts as required.

Table 27. Troubleshooting (continued)

None of the LEDs on an individual component are on.	Component might not be seated correctly.	Ensure that the SAN384B-2 has power and component is firmly seated. If problem continues, run the sensorShow command to determine component status. If component is a CP blade or port blade, enter the slotShow command to determine the status.
	Component might have failed.	Replace the component as necessary.
CP blades are failing over frequently.	There is excessive serial port activity.	Ensure that the serial port activity remains below the specified amount.
	CP blade is attached to an Ethernet with high traffic loads.	Ensure that Ethernet traffic remains below specified amount.
	Chassis is overheated.	Enter the tempShow and sensorShow commands to check the internal temperature. If components are overheating, shut down port blades as necessary to return the temperature to operating range. Also try moving the blades within the chassis since it is possible that airflow might not be adequate to cool everything in certain configurations.
One or more port or router blades have either shut down or failed POST as indicated by the error log.	Blades might be overheated.	Enter the sensorShow command to check the internal temperature readings. If components are overheating, shut down port blades as necessary to return the temperature readings to the operating ranges. Also try moving the blades within the chassis since it is possible that airflow might not be adequate to cool everything in certain configurations.
	Blades might be faulty.	Enter the slotShow command to determine status. For more information, enter the diagDisablePost command; then, the slotPowerOff [slot number] and slotPowerOn [slot number] command. Resolve the source of the problem or replace the blade as required.
	Pins on the blade or the backplane might be damaged.	Remove the blade from the chassis and inspect pins on the blade and on the backplane inside the slot. Do not reinstall if pins on either component are visibly damaged, as this could damage pins on other component. Replace the components as required.
An individual component is not operating as expected.	Component may not have power or may not be firmly seated.	Ensure component is receiving power (power LED should be on) and component is firmly seated.
	Pins on the component or the backplane might be damaged.	Remove the component from the chassis and inspect the pins on the component and inside the chassis. Do not reinstall if pins on either component are visibly damaged, as this could damage pins on other component. Replace parts as required.
	The component might have failed.	Enter the tempShow and sensorShow commands to determine component status. If component is a CP blade or port blade, enter the slotShow command to determine the status. Replace the component as necessary.

Appendix D. Port numbering

The illustrations in this appendix show the port numbering for the different SAN384B-2 blades. See “Port numbering” on page 29 for details on the port numbering pattern for the different blades.

- Figure 52 shows a CR16-4 core blade
- Figure 53 on page 142 shows an FC16-32 port blade
- Figure 54 on page 142 shows an FC16-48 port blade
- Figure 55 on page 142 shows an FC8-32E port blade
- Figure 56 on page 143 shows an FC8-48E port blade
- Figure 57 on page 143 shows an FC8-64 port blade
- Figure 58 on page 143 shows an FS8-18 encryption blade
- Figure 59 on page 143 shows an FX8-24 extension blade

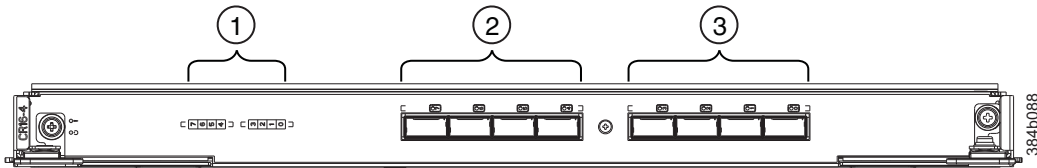

Figure 52. CR16-4 core blade

- | | | | |
|----------|--------------------------------|----------|--------------------------------|
| 1 | Port map | 3 | QSFP ports 0-3 (right to left) |
| 2 | QSFP ports 4-7 (right to left) | | |

Table 28 shows the mappings from the numbered ports on the face of the core blade to the port mappings as shown by the **slotShow** command. Each external port maps to four actual ports.

Table 28. External port to **slotShow** port mapping for CR16-4 core blades

External port number	slotShow port numbers	External port number	slotShow port numbers
0	0-3	4	16-19
1	4-7	5	20-23
2	8-11	6	24-27
3	12-15	7	28-31

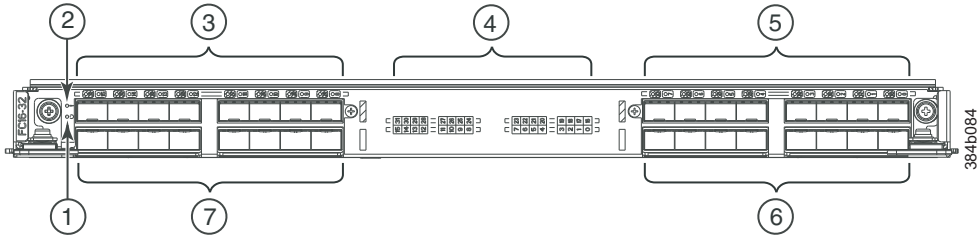

Figure 53. FC16-32 port blade

- | | | | |
|----------|-----------------------------|----------|----------------|
| 1 | Power LED | 5 | FC ports 16-23 |
| 2 | Status LED | 6 | FC ports 0-7 |
| 3 | FC ports 24-31 | 7 | FC ports 8-15 |
| 4 | Port and trunking group map | | |

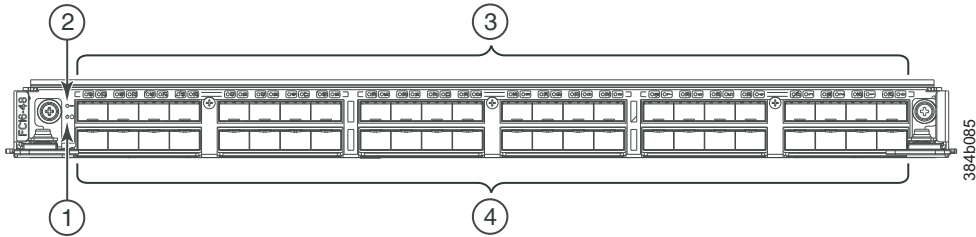

Figure 54. FC16-48 port blade

- | | | | |
|----------|------------|----------|----------------|
| 1 | Power LED | 3 | FC ports 24-47 |
| 2 | Status LED | 4 | FC ports 0-23 |

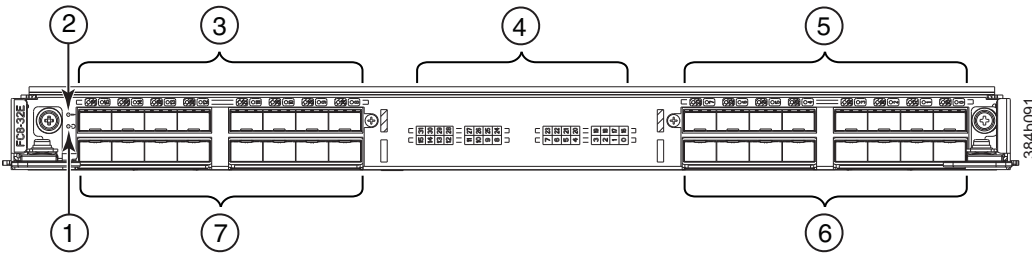

Figure 55. FC8-32E port blade

- | | | | |
|----------|-----------------------------|----------|----------------|
| 1 | Power LED | 5 | FC ports 16-23 |
| 2 | Status LED | 6 | FC ports 0-7 |
| 3 | FC ports 24-31 | 7 | FC ports 8-15 |
| 4 | Port and trunking group map | | |

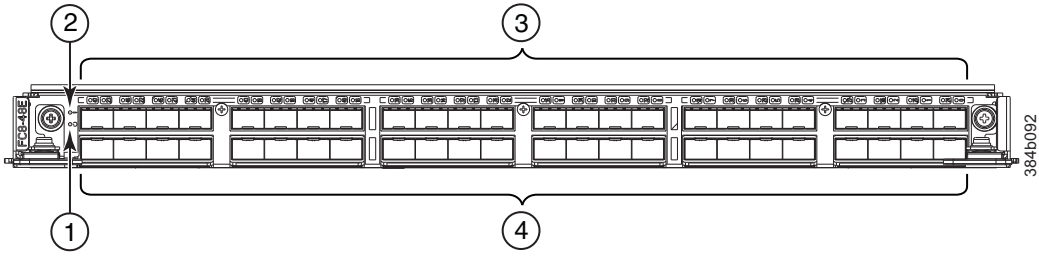

Figure 56. FC8-48E port blade

- | | | | |
|----------|------------|----------|----------------|
| 1 | Power LED | 3 | FC ports 24-47 |
| 2 | Status LED | 4 | FC ports 0-23 |

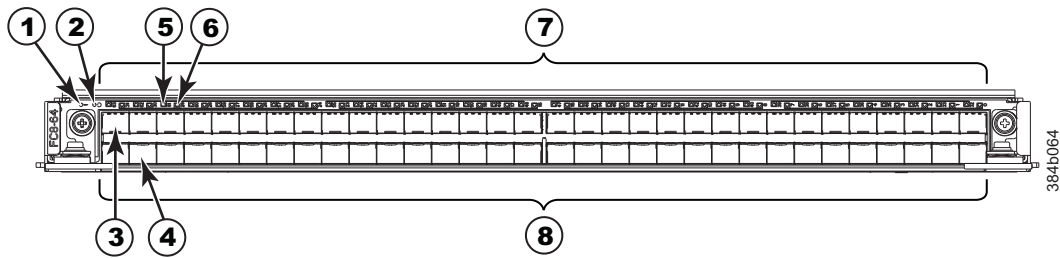

Figure 57. FC8-64 port blade

- | | | | |
|----------|------------|----------|--------------------------------|
| 1 | Status LED | 5 | Port 61 LED |
| 2 | Power LED | 6 | Port 29 LED |
| 3 | Port 63 | 7 | FC ports 32-63 (right to left) |
| 4 | Port 30 | 8 | FC ports 0-31 (right to left) |

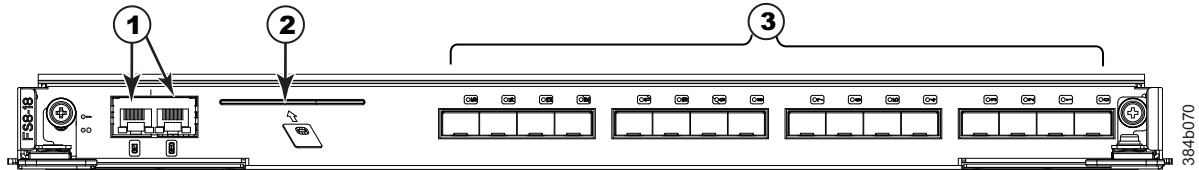

Figure 58. FS8-18 encryption blade

- | | | | |
|----------|--------------------------------|----------|-------------------------------------|
| 1 | Gigabit Ethernet ports GE0-GE1 | 2 | Key management smart card interface |
| 3 | FC ports 0-15 | | |

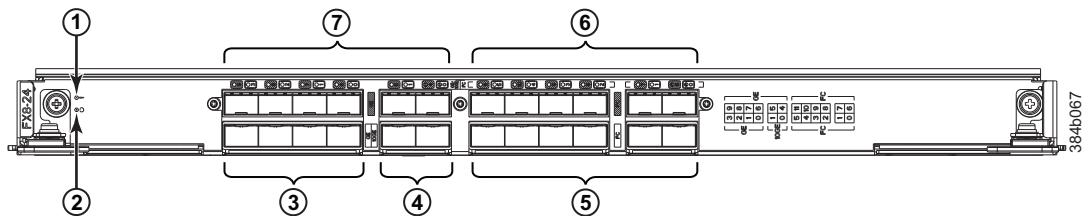

Figure 59. FX8-24 extension blade

- | | | | |
|----------|---|----------|--|
| 1 | Status LED | 5 | FC ports 0-5 (numbered right to left) |
| 2 | Power LED | 6 | FC ports 6-11 (numbered right to left) |
| 3 | 1 GbE ports 0-3 (numbered right to left) | 7 | 1 GbE ports 4-9 (numbered right to left) |
| 4 | 10 GbE ports 0-1 (numbered right to left) | | |

Notices

This information was developed for products and services offered in the USA.

IBM may not offer the products, services, or features discussed in this document in other countries. Consult your local IBM representative for information on the products and services currently available in your area. Any reference to an IBM product, program, or service is not intended to state or imply that only that IBM product, program, or service may be used. Any functionally equivalent product, program, or service that does not infringe on any IBM intellectual property right may be used instead. However, it is the user's responsibility to evaluate and verify the operation of any non-IBM product, program, or service.

IBM may have patents or pending patent applications covering subject matter described in this document. The furnishing of this document does not give you any license to these patents. You can send license inquiries, in writing to:

*IBM Director of Licensing
IBM Corporation
North Castle Drive
Armonk, N.Y. 10504-1785
U.S.A.*

For additional information, visit the web at:
www.ibm.com/ibm/licensing/contact/

The following paragraph does not apply to the United Kingdom or any other country where such provisions are inconsistent with local law:

INTERNATIONAL BUSINESS MACHINES CORPORATION PROVIDES THIS PUBLICATION "AS IS" WITHOUT WARRANTY OF ANY KIND, EITHER EXPRESS OR IMPLIED, INCLUDING, BUT NOT LIMITED TO, THE IMPLIED WARRANTIES OF NON-INFRINGEMENT, MERCHANTABILITY OR FITNESS FOR A PARTICULAR PURPOSE. Some states do not allow disclaimer of express or implied warranties in certain transactions, therefore, this statement may not apply to you.

This information could include technical inaccuracies or typographical errors. Changes are periodically made to the information herein; these changes will be incorporated in new editions of the publication. IBM may make improvements and/or changes in the product(s) and/or the program(s) described in this publication at any time without notice.

Any references in this information to non-IBM web sites are provided for convenience only and do not in any manner serve as an endorsement of those web sites. The materials at those web sites are not part of the materials for this IBM product and use of those web sites is at your own risk.

IBM may use or distribute any of the information you supply in any way it believes appropriate without incurring any obligation to you.

Any performance data contained herein was determined in a controlled environment. Therefore, the results obtained in other operating environments may vary significantly. Some measurements may have been made on development-level

systems and there is no guarantee that these measurements will be the same on generally available systems. Furthermore, some measurement may have been estimated through extrapolation. Actual results may vary. Users of this document should verify the applicable data for their specific environment.

Information concerning non-IBM products was obtained from the suppliers of those products, their published announcements or other publicly available sources. IBM has not tested those products and cannot confirm the accuracy of performance, compatibility or any other claims related to non-IBM products. Questions on the capabilities of non-IBM products should be addressed to the suppliers of those products.

If you are viewing this information in softcopy, the photographs and color illustrations may not appear.

Trademarks

IBM, the IBM logo, and [ibm.com](http://www.ibm.com)[®] are trademarks or registered trademarks of International Business Machines Corporation in the United States, other countries, or both. A complete and current list of other IBM trademarks is available on the Web at www.ibm.com/legal/copytrade.shtml

Adobe, the Adobe logo, PostScript, and the PostScript logo are either registered trademarks or trademarks of Adobe Systems Incorporated in the United States, and/or other countries.

Java and all Java-based trademarks and logos are trademarks of Sun Microsystems, Inc. in the United States, other countries, or both.

Linux is a registered trademark of Linus Torvalds in the United States, other countries, or both.

Microsoft and Windows are trademarks of Microsoft Corporation in the United States, other countries, or both.

UNIX is a registered trademark of The Open Group in the United States and other countries.

Other product and service names might be trademarks of IBM or other companies.

Electronic emission notices

The following statements apply to this product. The statements for other products intended for use with this product will appear in their accompanying manuals.

Federal Communications Commission (FCC) Class A Statement

This equipment has been tested and complies with the limits for a Class A digital device, pursuant to Part 15 of the FCC Rules. These limits are designed to provide reasonable protection against harmful interference when the equipment is operated in a commercial environment. This equipment generates, uses, and can radiate radio frequency energy and, if not installed and used in accordance with the instruction manual, may cause harmful interference to radio communications.

Operation of this equipment in a residential area is likely to cause harmful interference, in which case the user will be required to correct the interference at his own expense.

Properly shielded and grounded cables and connectors must be used in order to meet FCC emission limits. IBM is not responsible for any radio or television interference caused by using other than recommended cables and connectors or by unauthorized changes or modifications to this equipment. Unauthorized changes or modifications could void the user's authority to operate the equipment.

This device complies with Part 15 of the FCC Rules. Operation is subject to the following two conditions: (1) this device may not cause harmful interference, and (2) this device must accept any interference received, including interference that may cause undesired operation.

Industry Canada Class A Emission Compliance Statement

This Class A digital apparatus complies with Canadian ICES-003.

Avis de conformité à la réglementation d'Industrie Canada

Cet appareil numérique de la classe A est conforme à la norme NMB-003 du Canada.

European Union EMC Directive Conformance Statement

This product is in conformity with the protection requirements of EU Council Directive 2004/108/EC on the approximation of the laws of the Member States relating to electromagnetic compatibility. IBM cannot accept responsibility for any failure to satisfy the protection requirements resulting from a non-recommended modification of the product, including the fitting of non-IBM option cards.

Attention: This is an EN55022 Class A product. In a domestic environment this product may cause radio interference in which case the user may be required to take adequate measures.

Responsible manufacturer:
International Business Machines Corp.
New Orchard Road
Armonk, New York 10504
Tel: 919-499-1900

European community contact:
IBM Deutschland GmbH
Technical Regulations, Department M456
IBM-Allee 1, 71139 Ehningen, Germany

Germany Electromagnetic Compatibility Directive

Deutschsprachiger EU Hinweis:

Hinweis für Geräte der Klasse A EU-Richtlinie zur Elektromagnetischen Verträglichkeit

Dieses Produkt entspricht den Schutzanforderungen der EU-Richtlinie 2004/108/EG zur Angleichung der Rechtsvorschriften über die elektromagnetische Verträglichkeit in den EU-Mitgliedsstaaten und hält die Grenzwerte der EN 55022 Klasse A ein.

Um dieses sicherzustellen, sind die Geräte wie in den Handbüchern beschrieben zu installieren und zu betreiben. Des Weiteren dürfen auch nur von der IBM empfohlene Kabel angeschlossen werden. IBM übernimmt keine Verantwortung für die Einhaltung der Schutzanforderungen, wenn das Produkt ohne Zustimmung der IBM verändert bzw. wenn Erweiterungskomponenten von Fremdherstellern ohne Empfehlung der IBM gesteckt/eingebaut werden.

EN 55022 Klasse A Geräte müssen mit folgendem Warnhinweis versehen werden: "Warnung: Dieses ist eine Einrichtung der Klasse A. Diese Einrichtung kann im Wohnbereich Funk-Störungen verursachen; in diesem Fall kann vom Betreiber verlangt werden, angemessene Maßnahmen zu ergreifen und dafür aufzukommen."

Deutschland: Einhaltung des Gesetzes über die elektromagnetische Verträglichkeit von Geräten

Dieses Produkt entspricht dem "Gesetz über die elektromagnetische Verträglichkeit von Geräten (EMVG)". Dies ist die Umsetzung der EU-Richtlinie 2004/108/EG in der Bundesrepublik Deutschland.

Zulassungsbescheinigung laut dem Deutschen Gesetz über die elektromagnetische Verträglichkeit von Geräten (EMVG) (bzw. der EMC EG Richtlinie 2004/108/EG) für Geräte der Klasse A

Dieses Gerät ist berechtigt, in Übereinstimmung mit dem Deutschen EMVG das EG-Konformitätszeichen - CE - zu führen.

Verantwortlich für die Einhaltung der EMV Vorschriften ist der Hersteller:
International Business Machines Corp.
New Orchard Road
Armonk, New York 10504
Tel: 919-499-1900

Der verantwortliche Ansprechpartner des Herstellers in der EU ist:
IBM Deutschland GmbH
Technical Regulations, Abteilung M456
IBM-Allee 1, 71139 Ehningen, Germany

Generelle Informationen:

Das Gerät erfüllt die Schutzanforderungen nach EN 55024 und EN 55022 Klasse A.

People's Republic of China Class A Electronic Emission Statement

中华人民共和国“A类”警告声明

声明

此为A级产品，在生活环境中，该产品可能会造成无线电干扰。在这种情况下，可能需要用户对其干扰采取切实可行的措施。

Japan Voluntary Control Council for Interference (VCCI) Class A Statement

この装置は、クラス A 情報技術装置です。この装置を家庭環境で使用する
と電波妨害を引き起こすことがあります。この場合には使用者が適切な対策
を講ずるよう要求されることがあります。 VCCI-A

Translation: This is a Class A product based on the standard of the VCCI Council. If this equipment is used in a domestic environment, radio interference may occur, in which case, the user may be required to take corrective actions.

Japan Electronics and Information Technology Industries Association (JEITA) Statement

Japanese Electronics and Information Technology Industries Association (JEITA)
Confirmed Harmonics Guideline (products greater than 20 A per phase).

高調波ガイドライン準用品

jeita2

Korea Communications Commission (KCC) Class A Statement

Please note that this equipment has obtained EMC registration for commercial use. In the event that it has been mistakenly sold or purchased, please exchange it for equipment certified for home use.

이 기기는 업무용(A급)으로 전자파적합기기로서 판매자 또는 사용자는 이 점을 주의하시기
바라며, 가정외의 지역에서 사용하는 것을 목
적으로 합니다.

Russia Electromagnetic Interference (EMI) Class A Statement

ВНИМАНИЕ! Настоящее изделие относится к классу А.
В жилых помещениях оно может создавать
радиопомехи, для снижения которых необходимы
дополнительные меры

rusemi

Australia and New Zealand Class A Statement

Attention: This is a Class A product. In a domestic environment this product might cause radio interference in which case the user might be required to take adequate measures.

Taiwan Class A Electronic Emission Statement

警告使用者：
這是甲類的資訊產品，在
居住的環境中使用時，可
能會造成射頻干擾，在這
種情況下，使用者會被要
求採取某些適當的對策。

latemi

Index

Numerics

- 24-inch load plate
 - part number 12
- 384B-2
 - unpacking 17

A

- about this document xxvii
 - how to send your comments iv
- ac power
 - removing xxiv
- accessibility features for this
 - product xxviii
- application blade
 - installing 70
 - removing 70
- attaching
 - Fibre cables 42
- attention notice
 - definition xxi
 - example xxi
- attention notices xxi

B

- backing up the configuration 47
- backup
 - configuration file 48
- blade
 - control processor 5
 - core switch 5
 - CP8 5
 - CR16-4 5
 - encryption 5
 - FC16-32 5
 - FC16-48 5
 - FC8-32E 5
 - FC8-48E 5
 - FC8-64 5
 - FCIP extension 5
 - FS8-18 5
 - FX8-24 5
 - port 5
 - weights 128
- blade filler panel
 - installing 72
 - removing 72
- blades
 - FC16-32 115
 - FC16-48 115
 - FC8-32E 117
 - FC8-48E 117
 - FC8-64 118
- blower assembly
 - installing 86, 87
 - LEDs 63
 - removing 86, 87
 - status 63

- Brocade
 - documents xxviii

C

- C36
 - cabinet 11
- cabinet
 - C36 11
 - SAN384B-2 installation 14
- cable management finger assembly
 - installing 68
 - removing 68
- cables
 - attaching 42
 - installing 42
 - managing 44
- caution notices xviii
 - definition xviii
 - examples xix
- chassis door 67
 - installing 67
 - removing 67
- chassis replacement
 - verifying need 99
- chassisShow
 - command 52
 - output example 52
- comments
 - sending iv
- component
 - status 51
- components
 - installing 67
 - monitoring 51
 - removing 67, 103
- configuration
 - backing up 47
 - download 106
 - encryption blade 33
 - parameters 36
- configuration file
 - backup 48
 - uploading 48
- configuring
 - encryption 46
 - SAN384B-2 33
- connection
 - serial 35
- connection, Ethernet 38
- control processor blade
 - components 60
 - CP8 5
 - LEDs 60
 - status 59, 60
- corcs, power 132
- core switch blade
 - components 61
 - CR16-4 5
 - LEDs 62
 - status 61, 62

- CP8
 - control processor blade 5
- CP8 blade
 - components 60
 - installing 73, 77
 - LEDs 60
 - removing 73, 76
 - status 59, 60
 - verifying 74
 - verifying operation 78
- CR16-4
 - core switch blade 5
- CR16-4 blade
 - components 61
 - installing 82, 83
 - LEDs 62
 - removing 82, 83
 - status 61, 62
- critical information
 - recording 75, 99

D

- danger notices xv
 - definitions xv
 - examples xv
- data transmission
 - distance 132
 - range 132
 - speed 132
- date
 - setting 39
- diagnostics 135
- director of licensing, address 145
- disconnecting
 - fabric 102
 - network 102
- documents
 - Brocade xxvii
 - product xxvii
- Domain ID
 - setting 39
- door, chassis 67
- double encryption
 - avoiding 47, 123
- download
 - configuration 106
- downloading
 - firmware 49

E

- edition notice ii
- electronic emission notices 146
- encryption
 - configuration tasks 46
 - configuring 46
 - double 47, 123
 - planning 45
 - pre-initialization tasks 46

- encryption (*continued*)
 - redundancy 45
- encryption blade
 - configuration 33
 - description 133
 - features 133
 - FS8-18 55
 - installing 70, 121
 - monitoring 55
 - removing 70
 - status 55
- environmental notices xv, xxv
- environmental requirements 129
- ESD 116, 117, 118
- ESD strap 118, 120, 121
- Ethernet connection 38
 - establishing 38
- exhaust kit
 - installing 21
 - parts 19
- extension blade
 - installing 120
- external machine checks xxiv

F

- fabric
 - reconnecting 108
- fabric configuration
 - verifying 108
- Fabric OS
 - compatibility 48
 - documents xxviii
 - firmware updates 48
 - release notes 48
- facility requirements 128
- FC16-32
 - port blade 5
- FC16-32 blade 55
 - components 55
 - installing 72
 - LEDs 58
 - removing 70
 - status 55, 58
- FC16-32 port blades 70, 115
- FC16-48
 - port blade 5
- FC16-48 blade 56
 - components 56
 - installing 72
 - LEDs 58
 - removing 70
 - status 55, 58
- FC16-48 port blades 70, 115
- FC3632
 - installing 32-port blade 115
- FC3633
 - installing Enhanced 32-port 8 Gbps blade 117
- FC3648
 - installing 48-port blade 115
 - installing Enhanced 48-port 8 Gbps blade 117
- FC3864
 - installing 64-port blade 118
- FC3890
 - FX8-24 blade 120

- FC3895
 - FS8-18 encryption blade 121
 - installing 121
- FC7230
 - FIPS seals 123
- FC7871
 - QSFP inter-chassis link (ICL) 123
- FC7872
 - QSFP inter-chassis link (ICL) 124
- FC8-32E
 - port blade 5
- FC8-32E blade 56
 - components 56
 - installing 72
 - removing 70
 - status 55
- FC8-32E port blades 70, 117
- FC8-48 port blades 70
- FC8-48E
 - port blade 5
- FC8-48E blade 56
 - components 56
 - installing 72
 - removing 70
 - status 55
- FC8-48E port blades 70, 117
- FC8-64
 - port blade 5
- FC8-64 blade 57
 - components 57
 - installing 72
 - LEDs 58
 - removing 70
 - status 55, 58
- FC8-64 port blades 70, 118
- FCIP extension blade
 - FX8-24 55
- features
 - high availability 7
 - installing 115
- features and components 1
- features, software 9
- Fibre cables
 - attaching 42
- FIPS seals
 - installing 123
- FIPS security seals 10
 - installation sequence 14
- firmware
 - downloading 49
 - installing 49
- firmware updates 48
- FRU
 - weights 128
- FRUs
 - Smart card 45
- FS8-18
 - description 133
 - encryption blade 133
 - encryption port blade 5
 - features 133
- FS8-18 blade
 - installing 72
 - removing 70
 - status 55
- FS8-18 encryption blade 57, 70
 - components 57

- FS8-18 encryption blade (*continued*)
 - installing 121
 - LEDs 58
 - status 58
- FX8-24
 - FCIP extension blade 5
- FX8-24 blade 133
 - installing 72, 120
 - removing 70
 - status 55
- FX8-24 extension blade 58
 - components 58, 144

G

- getting help iii

H

- help iii
- high availability 7
 - features 7
- how to send your comments iv

I

- IBM
 - notices 145
 - trademarks 146
- ICL
 - core/edge topology 96
 - full mesh topology 97
 - parallel cabling 95
- inspections, safety xxiv
- installation
 - planning 11
 - preparation 11
- installation guidelines 13
- installing 93
 - application blade 70
 - blade filler panel 72
 - blower assembly 86, 87
 - cable management finger assembly 68
 - chassis components 105
 - chassis door 67
 - components 67
 - CP8 blade 73, 77
 - CR16-4 blade 82, 83
 - encryption blade 70
 - exhaust kit 21
 - FC16-32 blade 72
 - FC16-48 blade 72
 - FC3890 120
 - FC3895 121
 - FC8-32E blade 72
 - FC8-48E blade 72
 - FC8-64 blade 72
 - features 115
 - FIPS seals 123
 - firmware 49
 - FS8-18 encryption blade 72, 121
 - FX8-24 blade 72, 120
 - inter-chassis link (ICL) cable 94
 - mSFP 89
 - mSFPs 42

- installing (*continued*)
 - port blade 70, 115, 117, 118
 - port-side exhaust kit 18
 - power supply 84, 86
 - QSFP inter-chassis link (ICL) 123, 124
 - replacement chassis 105
 - SAN384B-2 11, 14, 25
 - time required 14
 - SFP+ 89
 - SFP+s 42
 - WWN bezel and card 88
- installing components 67
- intellectual property 145
- inter-chassis link (ICL)
 - status 93
- inter-chassis link (ICL) cable
 - installing 94
- inter-chassis link (QSFP) cable
 - installing 93
 - removing 93, 94
- internal machine checks xxiv
- Interoperability Matrix 48
- introduction 1
- IP addresses
 - setting 36

L

- labels, safety xx
- LEDs
 - blower assembly 63
 - control processor blade 60
 - core switch blade 62
 - CP8 blade 60
 - CR16-4 blade 62
 - encryption blades 58
 - port blades 58
 - power supply 63
 - WWN card 65
- license, for patents 145
- licenses
 - software 41
- lift tool 12
 - 24-inch load plate 26
 - extension 26
 - assembly 16
 - ordering procedure 12
 - part number 12
 - positioning 25
 - United States ordering procedure 12
 - world trade ordering procedure 12
- local time
 - synchronizing 40
- login
 - serial console port 36

M

- machine checks
 - external xxiv
 - internal xxiv
- master keys 45
- modem 33
- mSFP 42
 - installing 89

- mSFP (*continued*)
 - removing 89
- mSFP transceivers 42
- mSFPs
 - compatible 42
 - installing 42

N

- network
 - reconnecting 108
- network manageability 10
- Network Management System 10
- notice, edition ii
- notices
 - attention xxi
 - caution xviii
 - danger xv
 - environmental xv, xxv
 - general 145
 - IBM 145
 - patents 145
 - safety xv
 - safety and environmental xv
 - types xv
- notices and labels
 - safety xv
- notices, attention xxi
- notices, caution xviii
- notices, danger xv
- NTP server 40

O

- ordering the lift tool and the 24-inch load plate 12
- organizing
 - cables 44
- overview 1

P

- parameters
 - configuration 36
- part number
 - 24-inch load plate 12
 - lift tool 12
- parts
 - power cords 132
- password 36
 - changing 36
 - saving 48
- patents 145
- PID mode, verifying 41
- planning
 - encryption 45
- port blade
 - FC16-32 55
 - FC16-48 55
 - FC8-32E 55
 - FC8-48E 55
 - FC8-64 55
 - FX8-24 55
 - installing 70, 72, 115, 117, 118
 - monitoring 55
 - removing 70

- port blade (*continued*)
 - status 55
- port blades, FC16-32 70, 115
- port blades, FC16-48 70
- port blades, FC8-32E 70, 117
- port blades, FC8-48E 70
- port blades, FC8-64 70, 118
- port groups
 - trunking 42
- port numbering 29, 30
- port-side exhaust kit
 - installing 18
- power
 - cords 132
 - off 49
 - SAN384B-2 35
- power specifications 130
- power supply
 - components 63
 - installing 84, 86
 - LEDs 63
 - removing 84
 - status 63
- product
 - components 2
 - disposal xxv
 - features 2
 - features and components 1
 - hardware components 2
 - introduction 1
 - overview 1
 - recycling xxv
 - reliability 8
 - serviceability 8
 - software features 9
 - specifications 125
- product disposal xxv
- product documents xxvii
- product recycling xxv
- product specifications 125
- providing power to the SAN384B-2 35

Q

- QSFP connector
 - status LED 62
- QSFP inter-chassis link (ICL)
 - installing 123, 124

R

- rack
 - safety xxii
- rack relocation safety xxiii
- rack safety xxii
- read this first iii
- reconnecting
 - fabric 108
 - network 108
 - system 108
- recording
 - critical information 75, 99
- release notes
 - Fabric OS 48
- reliability 8

- removing
 - ac power xxiv
 - application 70
 - blade filler panel 72
 - blower assembly 86, 87
 - cable management finger assembly 68
 - chassis door 67
 - components 67, 103
 - CP8 blade 73, 76
 - CR16-4 blade 82, 83
 - encryption 70
 - FC16-32 blade 70
 - FC16-48 blade 70
 - FC8-32E blade 70
 - FC8-48E blade 70
 - FC8-64 70
 - FS8-18 blade 70
 - FX8-24 blade 70
 - inter-chassis link (QSFP) cable 93, 94
 - mSFP 89
 - port blade 70
 - power supply 84
 - SAN384B-2 104
 - SFP+ 89
 - WWN bezel 88
 - WWN bezel and card 88
 - WWN card 88
- removing components 67
- replacement chassis
 - installing 105
- requirements
 - environmental 129
 - facility 128
- routing blade
 - status 55

S

- safety xv
 - inspections xxiv
 - labels xv, xx
 - examples xx
 - notices xv
 - rack xxii
 - rack installation xxii
 - rack relocation xxiii
- safety inspection
 - external machine checks xxiv
 - internal machine checks xxiv
- safety inspections xxiv
- safety labels xx
- safety notices xv
- safety, rack xxii
- safety, rack installation xxii
- safety, rack relocation xxiii
- SAN Switch Cabinet C36 11
- SAN384B-2
 - configuring 33
 - installation guidelines 13
 - installing 11, 25
 - IP addresses 36
 - library xxvii
 - physical dimensions 127
 - providing power 35
 - removing 104
 - size 127

- SAN384B-2 (*continued*)
 - starting 33
 - switch name 38
 - weight 127
 - security 9
 - security features 9
 - security features table 9
 - serial connection 35
 - serial connection, establishing 35
 - serial console port
 - login 36
 - serviceability 8
 - setting
 - date 39
 - Domain ID 39
 - IP addresses 36
 - time 39
 - timezone 40
 - SFP+ 42
 - installing 89
 - removing 89
 - SFP+ transceivers 42
 - SFP+s
 - compatible 42
 - installing 42
 - slot numbers 31
 - Smart card 45
 - SNMP 10
 - software features 9
 - software licenses 41
 - installed 41
 - specifications 125
 - power 130
 - specifications, product 125
 - standard features
 - software
 - Advanced Zoning 9
 - Fabric Watch 9
 - ISL Trunking 9
 - Performance Monitoring 9
 - Web Tools 9
 - standard software features 9
 - starting
 - SAN384B-2 33
 - status
 - blower assembly 63
 - control processor blade 60
 - core switch blade 61, 62
 - CP8 blade 60
 - CR16-4 blade 61, 62
 - encryption blades 58
 - FC16-32 blade 58
 - FC16-48 blade 58
 - FC8-64 blade 58
 - FS8-18 encryption blade 58
 - inter-chassis link (ICL) 93
 - port blades 58
 - power supply 63
 - QSFP connector 62
 - WWN card 65
 - strap, ESD 118, 120, 121
 - summary of changes iii
 - switch name
 - changing 38
 - switchShow
 - command 51
 - output example 51

- synchronizing
 - time zone 40
- system
 - power off 49
 - shutdown 49
- system architecture 125
- system component
 - status 51
- system components
 - monitoring 51
- system operation
 - verifying 107

T

- time
 - setting 39
- time required
 - installing a SAN384B-2 14
- time server
 - NTP 40
- time zone
 - setting 40
- torque requirements 21
- trademarks 146
- transceivers
 - mSFP 42
 - SFP+ 42
- transceivers, mSFP 42
- transceivers, SFP+ 42
- transmission range
 - multi-mode media 132
 - OM1 132
 - OM2 132
 - OM3 132
 - OM4 132
 - SFP types 132
 - single mode media 132
 - transceiver 132
- trunking
 - port groups 42

U

- unpacking
 - SAN384B-2 17

V

- verifying
 - CP8 blade 74
 - fabric configuration 108
 - system operation 107
- verifying operation
 - CP8 blade 78
- verifying PID mode 41

W

- Web sites iii
- weights
 - blade 128
 - FRU 128
- who should read this document xxvii

WWN
 bezel 65
 card
 status 65
WWN bezel
 installing 88
 removing 88
WWN card
 failure 65
 removing 88



Part Number: 98Y2654

Printed in USA

GA32-0894-03



(1P) P/N: 98Y2654

