

IBM TotalStorage SAN Volume Controller



# Configuration Guide

*Version 1.2.1*



IBM TotalStorage SAN Volume Controller



# Configuration Guide

*Version 1.2.1*

**Fourth Edition (October 2004)**

**Note:** Before using this information and the product it supports, read the information in "Notices."

**© Copyright International Business Machines Corporation 2003, 2004. All rights reserved.**

US Government Users Restricted Rights – Use, duplication or disclosure restricted by GSA ADP Schedule Contract with IBM Corp.

---

# Contents

<b>Figures</b> . . . . .	ix
<b>Tables</b> . . . . .	xi
<b>About this guide</b> . . . . .	xiii
Who should use this guide . . . . .	xiii
Summary of Changes . . . . .	xiii
Summary of Changes for SC26-7543-03 SAN Volume Controller Configuration Guide . . . . .	xiii
Emphasis . . . . .	xv
Numbering conventions . . . . .	xvi
SAN Volume Controller library and related publications . . . . .	xvi
Related Web sites . . . . .	xviii
How to order IBM publications . . . . .	xviii
How to send your comments . . . . .	xix
<b>Chapter 1. Overview</b> . . . . .	1
SAN Volume Controller . . . . .	1
Virtualization . . . . .	4
Asymmetric virtualization . . . . .	7
Symmetric virtualization . . . . .	8
Object overview . . . . .	9
Nodes and clusters . . . . .	11
I/O groups and Uninterruptible Power Supply . . . . .	15
Storage subsystems and managed disks . . . . .	20
Managed disk groups and virtual disks (VDisks) . . . . .	24
Hosts and virtual (VDisk) mappings . . . . .	29
Copy Services . . . . .	32
FlashCopy . . . . .	32
Remote Copy . . . . .	44
Configuration rules and requirements . . . . .	49
Configuration rules . . . . .	51
Configuration recommendations for large SANs . . . . .	60
Configuration requirements . . . . .	62
Maximum configuration . . . . .	64
Supported fibre-channel extenders . . . . .	66
Performance of fibre-channel extenders . . . . .	66
<b>Chapter 2. Preparing to configure the SAN Volume Controller</b> . . . . .	69
Create cluster from the front panel . . . . .	69
Overview of passwords . . . . .	71
Master console security overview . . . . .	72
Master console . . . . .	73
Validating the truststore certificate expiration . . . . .	74
Configuring the master console . . . . .	75
Configuring the network . . . . .	76
Configuring the browser . . . . .	78
Secure Shell (SSH) . . . . .	78
Configuring the Secure Shell (SSH) client system . . . . .	80
Configuring the master console host name . . . . .	84
Starting the Tivoli SAN Manager . . . . .	85
Setting up Remote Support . . . . .	86
IBM Director . . . . .	88

Configuring IBM Director for the SAN Volume Controller Call-Home and Event Notification . . . . .	89
Upgrading software on the master console. . . . .	94
Connecting to the Remote Support Center. . . . .	95
Clearing the Windows event logs . . . . .	95
Troubleshooting master console problems . . . . .	96
Installing antivirus software . . . . .	98

<b>Chapter 3. SAN Volume Controller Console . . . . .</b>	<b>101</b>
Using the SAN Volume Controller Console . . . . .	101
Accessing the SAN Volume Controller Console . . . . .	102
SAN Volume Controller Console layout . . . . .	103
SAN Volume Controller Console banner area . . . . .	103
SAN Volume Controller Console task bar. . . . .	104
SAN Volume Controller Console portfolio . . . . .	104
SAN Volume Controller Console work area . . . . .	104
Upgrading the SAN Volume Controller Console software . . . . .	104
Overview of creating a cluster using the SAN Volume Controller Console . . . . .	105
Browser requirements for the SAN Volume Controller . . . . .	105
Configuring a cluster using the SAN Volume Controller Console . . . . .	106
Launching the SAN Volume Controller Console . . . . .	114
Setting cluster time . . . . .	116
Displaying cluster properties using the SAN Volume Controller Console . . . . .	117
Scenario: typical usage for the SAN Volume Controller Console . . . . .	118
Adding nodes to a cluster . . . . .	120
Displaying node properties using the SAN Volume Controller Console . . . . .	125
Creating managed disk groups . . . . .	125
Creating virtual disks . . . . .	127
Using image mode virtual disks . . . . .	127
Creating hosts. . . . .	131
Showing VDisks mapped to a host . . . . .	132
Creating consistency groups . . . . .	133
Creating FlashCopy mappings. . . . .	133
Advanced function FlashCopy overview . . . . .	134
Starting FlashCopy mappings . . . . .	135
Stopping FlashCopy mappings . . . . .	135
Deleting FlashCopy mappings . . . . .	135
Starting FlashCopy consistency groups . . . . .	136
Stopping FlashCopy consistency groups . . . . .	136
Deleting FlashCopy consistency groups . . . . .	137
Advanced functions overview for the SAN Volume Controller Console . . . . .	137
Determining the WWPNs for a node using the SAN Volume Controller Console . . . . .	138
Determining the relationship between VDisks and MDisks using the SAN Volume Controller Console . . . . .	138
Determining the relationship between managed disks and RAID arrays or LUNs using the SAN Volume Controller Console . . . . .	139
Increasing the size of your cluster using the SAN Volume Controller Console . . . . .	139
Replacing a faulty node with a spare node using the SAN Volume Controller Console . . . . .	142
Recovering from offline VDisks after a node or an I/O group failed . . . . .	146
Replacing an HBA in a host using the SAN Volume Controller Console . . . . .	148
Deleting hosts. . . . .	149
Shrinking virtual disks . . . . .	149
Migrating virtual disks . . . . .	150
Creating image-mode virtual disks . . . . .	151

Advanced function Remote Copy overview . . . . .	152
Advanced function cluster overview . . . . .	152
<b>Chapter 4. Command-Line Interface . . . . .</b>	<b>169</b>
Using the Command-Line Interface (CLI) . . . . .	169
Preparing the SSH client system overview . . . . .	170
Preparing the SSH client system to issue command-line interface commands . . . . .	171
Preparing the SSH client on an AIX host . . . . .	172
Issuing CLI commands from a PuTTY SSH Client system . . . . .	174
Running the PuTTY and plink utilities . . . . .	174
Configuring the cluster using the CLI . . . . .	177
Setting the cluster time using the CLI . . . . .	178
Reviewing and setting the cluster features using the CLI . . . . .	178
Displaying cluster properties using the CLI . . . . .	179
Maintaining passwords using the CLI . . . . .	179
Scenario: typical usage for the command-line interface. . . . .	179
Adding nodes to a cluster using the CLI . . . . .	181
Displaying node properties using the CLI . . . . .	186
Discovering MDisks using the CLI . . . . .	187
Creating managed disk (MDisk) groups using the CLI . . . . .	188
Adding MDisks to MDisk groups using the CLI . . . . .	190
Create virtual disks (VDisks) . . . . .	191
Creating host objects using the CLI . . . . .	194
Create VDisk-to-host mappings using the CLI . . . . .	195
Create FlashCopy mappings using the CLI . . . . .	195
Creating a FlashCopy consistency group and adding mappings using the CLI . . . . .	196
Preparing and triggering a FlashCopy mapping using the CLI . . . . .	197
Preparing and triggering a FlashCopy Consistency Group using the CLI . . . . .	198
Advanced functions with the CLI . . . . .	200
Determining the WWPNs of a node using the CLI . . . . .	200
Determining the VDisk name from the vpath number on the host . . . . .	201
Determining the host that a VDisk is mapped to . . . . .	202
Determining the relationship between VDIsks and MDisks using the CLI . . . . .	202
Determining the relationship between MDisks and RAID arrays or LUNs using the CLI . . . . .	203
Increasing the size of your cluster using the CLI . . . . .	203
Replacing a faulty node in the cluster using the CLI . . . . .	206
Recovering from offline VDIsks after a node or an I/O group failed using the CLI . . . . .	210
Replacing an HBA in a host using the CLI . . . . .	213
Expanding VDIsks . . . . .	214
Shrinking a VDisk using the CLI . . . . .	217
Migrating extents using the CLI . . . . .	217
Migrating VDIsks between MDisk groups using the CLI. . . . .	219
Migrating a VDisk between I/O groups using the CLI . . . . .	220
Creating an image mode VDisk from an unmanaged MDisk using the CLI . . . . .	221
Advanced function cluster overview using the CLI . . . . .	222
<b>Chapter 5. Backing up and restoring the cluster configuration . . . . .</b>	<b>231</b>
Backing up the cluster configuration. . . . .	231
Restoring the cluster configuration . . . . .	234
Deleting a backup configuration file . . . . .	238
<b>Chapter 6. Software upgrade strategy . . . . .</b>	<b>241</b>

Disruptive software upgrade . . . . .	242
Upgrading the SAN Volume Controller firmware using the SAN Volume Controller Console . . . . .	243
Performing the node rescue. . . . .	246
Automatic upgrade . . . . .	247
Automatic recovery from upgrade problems . . . . .	247
PuTTY scp . . . . .	248
Installing the upgrade using the CLI. . . . .	249
Installing the software . . . . .	250
Manual recovery from software upgrade problems . . . . .	251

**Chapter 7. Configuring other SAN devices and SAN switches for use with the SAN Volume Controller . . . . .**

Configuring and servicing storage subsystems . . . . .	253
Identifying your storage subsystem . . . . .	254
Configuration guidelines . . . . .	254
Configuring a balanced storage subsystem . . . . .	260
Expanding a logical unit . . . . .	263
Modifying a logical unit mapping . . . . .	264
Storage subsystem tasks using the SAN Volume Controller Console. . . . .	265
Controller tasks using the CLI . . . . .	269
Creating a quorum disk . . . . .	272
Manual discovery . . . . .	273
Servicing storage subsystems . . . . .	273
Configuring the EMC CLARiiON subsystem . . . . .	273
Access Logix . . . . .	274
Configuring the EMC CLARiiON controller with Access Logix installed . . . . .	274
Configuring the EMC CLARiiON controller (Access Logix not installed) . . . . .	277
Supported models of the EMC CLARiiON . . . . .	277
Supported firmware levels for the EMC CLARiiON . . . . .	278
Concurrent maintenance on the EMC CLARiiON . . . . .	278
User interface on CLARiiON . . . . .	278
Sharing the EMC CLARiiON between a host and the SAN Volume Controller . . . . .	279
Switch zoning limitations for the EMC CLARiiON . . . . .	279
Quorum disks on the EMC CLARiiON . . . . .	280
Advanced functions for the EMC CLARiiON. . . . .	280
Logical unit creation and deletion on the EMC CLARiiON. . . . .	281
Configuring settings for the EMC CLARiiON. . . . .	281
Configuring the EMC Symmetrix subsystem. . . . .	285
Supported models of the EMC Symmetrix controller. . . . .	285
Supported firmware levels for the EMC Symmetrix controller . . . . .	286
Concurrent maintenance on the EMC Symmetrix . . . . .	286
User interface on Symmetrix . . . . .	287
Sharing the EMC Symmetrix controller between a host and the SAN Volume Controller . . . . .	287
Switch zoning limitations for the EMC Symmetrix . . . . .	288
Quorum disks on EMC Symmetrix . . . . .	288
Advanced functions for EMC Symmetrix . . . . .	289
Logical unit creation and deletion on EMC Symmetrix . . . . .	289
Configuration interface for the EMC Symmetrix . . . . .	290
Configuring settings for the EMC Symmetrix . . . . .	290
Configuring the Enterprise Storage Server . . . . .	293
Configuring the Enterprise Storage Server (ESS). . . . .	293
Supported models of the ESS . . . . .	295
Supported firmware levels for the ESS. . . . .	295
Concurrent maintenance on the ESS . . . . .	295



	User interface on ESS . . . . .	295
	Sharing the ESS between a host and the SAN Volume Controller . . . . .	296
	Switch zoning limitations for the ESS . . . . .	296
	Quorum disks on the ESS . . . . .	296
	Advanced functions for the ESS . . . . .	297
	Logical unit creation and deletion on the ESS . . . . .	297
	Configuring the FAStT subsystem . . . . .	298
	Configuring FAStT disk controllers for the storage server . . . . .	299
	Support actions for the FAStT controller . . . . .	300
	Supported models of the IBM FAStT controller . . . . .	302
	Supported firmware levels for the FAStT . . . . .	302
	Concurrent maintenance on the IBM FAStT . . . . .	302
	User interface on FAStT . . . . .	302
	Sharing the IBM FAStT controller between a host and the SAN Volume Controller . . . . .	303
	Quorum disks on the IBM FAStT . . . . .	303
	Advanced functions for the IBM FAStT . . . . .	303
	Logical unit creation and deletion on the IBM FAStT . . . . .	305
	Configuration interface for the IBM FAStT . . . . .	305
	Controller settings for the IBM FAStT . . . . .	306
	Configuring the HDS Lightning subsystem . . . . .	309
	Supported models of the HDS Lightning . . . . .	310
	Supported firmware levels for HDS Lightning . . . . .	310
	Concurrent maintenance on the HDS Lightning 99xxV . . . . .	311
	User interface on Lightning . . . . .	311
	Sharing the HDS Lightning 99xxV between host and the SAN Volume Controller. . . . .	311
	Quorum disks on HDS Lightning 99xxV . . . . .	312
	Advanced functions for HDS Lightning . . . . .	312
	LU configuration for Lightning . . . . .	313
	Configuring settings for Lightning . . . . .	315
	Configuring the HDS Thunder subsystem. . . . .	317
	Supported models of the HDS Thunder . . . . .	317
	Supported firmware levels for HDS Thunder. . . . .	318
	Concurrent maintenance on the HDS Thunder . . . . .	318
	User interface on the HDS Thunder. . . . .	318
	Sharing the HDS Thunder between host and the SAN Volume Controller Setting up a Thunder with more than four ports . . . . .	319
	Quorum disks on HDS Thunder . . . . .	320
	Advanced functions for HDS Thunder . . . . .	321
	Logical unit creation and deletion on HDS Thunder . . . . .	322
	Configuring settings for HDS Thunder . . . . .	323
	Configuring the HP StorageWorks subsystem . . . . .	328
	HP StorageWorks definitions . . . . .	330
	Configuring the HP StorageWorks controller. . . . .	332
	Supported models of the HP StorageWorks controller . . . . .	335
	Supported firmware levels for the HP StorageWorks controller . . . . .	336
	Concurrent maintenance on the HP StorageWorks . . . . .	336
	Configuration interface for the HP StorageWorks . . . . .	337
	Sharing the HP StorageWorks controller between a host and the SAN Volume Controller . . . . .	337
	Switch zoning limitations for the HP StorageWorks subsystem . . . . .	338
	Quorum disks on HP StorageWorks. . . . .	338
	Support for HP StorageWorks advanced functions . . . . .	339
	HP StorageWorks advanced functions . . . . .	340
	Logical unit creation and deletion on the HP StorageWorks . . . . .	340

Configuring settings for the HP StorageWorks . . . . .	341
Configuring the HPQ Enterprise Virtual Array (EVA) subsystem. . . . .	346
Supported models of the HPQ EVA . . . . .	346
Supported firmware levels for HPQ EVA . . . . .	347
User interface on HPQ EVA. . . . .	347
Sharing the HPQ EVA controller between a host and the SAN Volume Controller . . . . .	347
Switch zoning limitations for the HPQ EVA subsystem . . . . .	348
Quorum disks on HPQ EVA. . . . .	348
Support for HPQ EVA advanced functions . . . . .	348
Logical unit configuration on the HPQ EVA . . . . .	348
Logical unit presentation . . . . .	349
Configuration interface for the HPQ EVA . . . . .	350
Configuring settings for the HPQ EVA . . . . .	350
Switch zoning for the SAN Volume Controller . . . . .	351
Zoning considerations for Remote Copy . . . . .	354
Switch operations over long distances . . . . .	355
<b>Reference . . . . .</b>	<b>357</b>
Installing or upgrading the IBM TotalStorage SAN Volume Controller Console for Windows . . . . .	357
Installation overview for the SAN Volume Controller Console . . . . .	358
SAN Volume Controller Console hardware installation requirements . . . . .	359
SAN Volume Controller Console workstation space requirements . . . . .	360
SAN Volume Controller Console software installation requirements . . . . .	360
Installing or upgrading the SAN Volume Controller Console in graphical mode . . . . .	361
Installing or upgrading the SAN Volume Controller Console in unattended (silent) mode . . . . .	366
Verifying the Windows services associated with the SAN Volume Controller Console . . . . .	371
Post installation tasks . . . . .	371
Removing the SAN Volume Controller Console . . . . .	374
Valid combinations of FlashCopy and Remote Copy functions . . . . .	376
Setting up SNMP traps . . . . .	376
Configuring IBM Director overview . . . . .	377
Setting up an event action plan . . . . .	377
Setting up an e-mail . . . . .	378
Setting up an e-mail user notification . . . . .	379
Object types . . . . .	380
Event codes . . . . .	381
Information event codes . . . . .	381
Configuration event codes . . . . .	383
Accessibility . . . . .	386
Notices . . . . .	387
Trademarks. . . . .	389
Glossary . . . . .	389
<b>Index . . . . .</b>	<b>399</b>

---

## Figures

1. A SAN Volume Controller node . . . . .	2
2. Example of a SAN Volume Controller in a fabric . . . . .	3
3. Levels of virtualization . . . . .	6
4. Asymmetrical virtualization . . . . .	7
5. Symmetrical virtualization . . . . .	8
6. Virtualization . . . . .	10
7. Cluster, nodes, and cluster state. . . . .	12
8. Configuration node . . . . .	15
9. I/O group and uninterruptible power supply . . . . .	16
10. Uninterruptible power supply . . . . .	17
11. I/O groups and uninterruptible power supply relationship . . . . .	19
12. Controllers and MDisks . . . . .	22
13. MDisk group . . . . .	26
14. Managed disk groups and VDisks . . . . .	27
15. Hosts, WWPNs, and VDisks . . . . .	31
16. Hosts, WWPNs, VDisks and SCSI mappings . . . . .	32
17. Disk controller system shared between SAN Volume Controller and a host . . . . .	53
18. ESS LUs accessed directly with a SAN Volume Controller . . . . .	54
19. FASTT direct connection with a SAN Volume Controller on one host . . . . .	55
20. Fabric with Inter-Switch Links between nodes in a cluster . . . . .	59
21. Fabric with Inter-Switch Links in a redundant configuration . . . . .	59
22. Basic frame layout . . . . .	103
23. Banner area . . . . .	103
24. Task bar . . . . .	104
25. Welcome panel . . . . .	107
26. Add Cluster panel . . . . .	108
27. Add Cluster panel . . . . .	109
28. Security alert panel . . . . .	109
29. Certificate Information panel . . . . .	110
30. Create New Cluster wizard . . . . .	111
31. Error Notification Settings panel . . . . .	112
32. Featurization Settings panel . . . . .	113
33. Add SSH public key panel . . . . .	114
34. Viewing clusters panels . . . . .	115
35. Welcome panel . . . . .	116
36. Cluster date and time settings panel . . . . .	117
37. View Cluster properties panel . . . . .	118
38. SAN Volume Controller Console Nodes panel. . . . .	121
39. Nodes panel . . . . .	122
40. Add node drop down list . . . . .	123
41. Add Node to Cluster panel . . . . .	124
42. Viewing general details panel . . . . .	125
43. SAN Volume Controller Console nodes panel . . . . .	156
44. Featurization settings . . . . .	235
45. Software upgrade panel . . . . .	244
46. Software upgrade - file upload panel . . . . .	244
47. Applying software upgrade panel . . . . .	245
48. Node-rescue-request display . . . . .	246
49. Destination Directory panel . . . . .	363
50. PuTTY Configuration panel . . . . .	364
51. Updating Embedded WAS Ports panel . . . . .	365



## Tables

1. Emphasis descriptions . . . . .	xv
2. Publications in the SAN Volume Controller library . . . . .	xvii
3. Other IBM publications . . . . .	xviii
4. Web sites . . . . .	xviii
5. Node state . . . . .	14
6. Managed disk status . . . . .	22
7. Managed disk group status . . . . .	25
8. Capacities of the cluster given extent size . . . . .	26
9. Virtual disk status . . . . .	28
10. FlashCopy mapping events . . . . .	37
11. Background copy. . . . .	43
12. SAN Volume Controller maximum configuration values . . . . .	64
13. Upgrading vendor software . . . . .	94
14. Reasons to upgrade IBM software . . . . .	94
15. Extent size . . . . .	189
16. Supported platforms and requirements . . . . .	214
17. Calculate the I/O rate. . . . .	261
18. Calculate the impact of FlashCopy relationships . . . . .	262
19. Determine if the storage subsystem is overloaded . . . . .	262
20. Supported models of the EMC CLARiiON . . . . .	277
21. EMC CLARiiON global settings supported by the SAN Volume Controller . . . . .	282
22. EMC CLARiiON controller settings supported by the SAN Volume Controller . . . . .	282
23. EMC CLARiiON port settings supported by the SAN Volume Controller . . . . .	283
24. EMC CLARiiON LU settings supported by the SAN Volume Controller. . . . .	284
25. Supported models of the EMC Symmetrix . . . . .	285
26. EMC Symmetrix global settings supported by the SAN Volume Controller . . . . .	291
27. EMC Symmetrix port settings supported by the SAN Volume Controller . . . . .	291
28. EMC Symmetrix LU settings supported by the SAN Volume Controller. . . . .	292
29. Supported models of the Enterprise Storage Server . . . . .	295
30. Supported models of the IBM FASTt controller . . . . .	302
31. IBM FASTt controller global settings supported by the SAN Volume Controller. . . . .	308
32. Supported HDS Lightning models . . . . .	310
33. Lightning global settings supported by the SAN Volume Controller . . . . .	315
34. Lightning controller settings supported by the SAN Volume Controller . . . . .	316
35. Lightning port settings supported by the SAN Volume Controller . . . . .	316
36. Lightning LU settings for the SAN Volume Controller . . . . .	316
37. Supported Thunder 9200 models . . . . .	317
38. Supported Thunder 95xxV models . . . . .	318
39. Thunder global settings supported by the SAN Volume Controller . . . . .	324
40. Thunder port settings supported by the SAN Volume Controller . . . . .	325
41. Thunder LU settings for the SAN Volume Controller . . . . .	327
42. Determining partition usage . . . . .	334
43. Supported models of the HP StorageWorks HSG80 . . . . .	336
44. HSG80 container types for logical unit configuration . . . . .	340
45. HSG80 global settings supported by the SAN Volume Controller . . . . .	341
46. HSG80 controller settings supported by the SAN Volume Controller . . . . .	342
47. HSG80 port settings supported by the . . . . .	343
48. HSG80 LU settings supported by the SAN Volume Controller . . . . .	344
49. HSG80 connection options and their required settings for the . . . . .	344
50. Supported HPQ EVA models . . . . .	347
51. HPQ EVA global settings supported by the SAN Volume Controller . . . . .	350
52. HPQ EVA LU settings supported by the SAN Volume Controller . . . . .	351
53. HPQ EVA host settings supported by the SAN Volume Controller . . . . .	351

I	54. Four hosts and their ports . . . . .	352
I	55. Six hosts and their ports . . . . .	353
	56. Valid combinations of FlashCopy and Remote Copy interactions . . . . .	376
	57. Object types . . . . .	380
	58. Information event codes . . . . .	382
	59. Configuration event codes . . . . .	383

---

## About this guide

The IBM TotalStorage SAN Volume Controller Configuration guide provides information that helps you configure and use the IBM® TotalStorage® SAN Volume Controller™.

The IBM TotalStorage SAN Volume Controller Configuration guide also describes the configuration tools, both command-line and Web based, that you can use to define, expand, and maintain the storage of the IBM TotalStorage SAN Volume Controller.

---

## Who should use this guide

The IBM TotalStorage SAN Volume Controller Configuration guide is intended for system administrators or others who install and use the SAN Volume Controller.

Before using the IBM TotalStorage SAN Volume Controller, you should have an understanding of storage area networks (SANs), the storage requirements of your enterprise, and the capabilities of your storage units.

### Related reference

“About this guide”

The IBM TotalStorage SAN Volume Controller Configuration guide provides information that helps you configure and use the IBM® TotalStorage® SAN Volume Controller™.

---

## Summary of Changes

This document contains terminology, maintenance, and editorial changes.

Technical changes or additions to the text and illustrations are indicated by a vertical line to the left of the change. This summary of changes describes new functions that have been added to this release.

### Related reference

“Summary of Changes for SC26-7543-03 SAN Volume Controller Configuration Guide”

The Summary of Changes provides a list of new, modified, and changed information since the last version of the guide.

## Summary of Changes for SC26-7543-03 SAN Volume Controller Configuration Guide

The Summary of Changes provides a list of new, modified, and changed information since the last version of the guide.

### New information

This topic describes the changes to this guide since the previous edition, SC26-7543-02. The following sections summarize the changes that have since been implemented from the previous version.

This version includes the following new information:

- Added the following new topics:
  - Background Copy bandwidth impact on foreground I/O latency

- Configuration recommendations for large SANs
- Queue depth
- Calculating a queue depth limit
- Homogeneous queue depth calculation
- Non-Homogeneous queue depth calculation
- Limiting the queue depth
- Validating the truststore certificate expiration
- Using image mode virtual disks
- Storing preexisting data onto the SAN Volume Controller
- Exposing LUN's on your existing storage to the cluster via switch zoning
- Image mode VDisk migration
- Migration methods
- Importing data by creating an image mode VDisk
- Reviewing and setting the cluster features using the SAN Volume Controller Console
- Updated the EMC CLARiiON subsystem section with the following new topics:
  - Access Logix
  - User interface on CLARiiON
- Updated the EMC Symmetrix subsystem section with the following new topic:
  - User interface on Symmetrix
- Updated the ESS subsystem section with the following new topics:
  - User interface on ESS
  - Target port groups for the ESS
- Updated the FASTT subsystem section with the following new topic:
  - User interface on FASTT
- Updated the HDS Lightning subsystem section with the following new topics:
  - User interface on Lightning
  - LU configuration for Lightning
  - Logical unit creation and deletion on HDS Lightning
  - Configuring settings for Lightning
  - Global settings for Lightning
  - Controller settings for Lightning
  - Port settings for Lightning
  - LU settings for Lightning
- Updated the HDS Thunder subsystem section with the following new topic:
  - User interface on the HDS Thunder
- Added support for the HPQ Enterprise Virtual Array (EVA) subsystem. This section includes the following new topics:
  - Supported models of the HPQ EVA
  - Supported firmware levels for HPQ EVA
  - User interface on HPQ EVA
  - Sharing the HPQ EVA controller between a host and the SAN Volume Controller
  - Switch zoning limitations for the HPQ EVA subsystem
  - Quorum disks on HPQ EVA



- Support for HPQ EVA advanced functions
- Logical unit configuration on the HPQ EVA
- Logical unit creation and deletion on the HPQ EVA
- Logical unit presentation
- Configuration interface for the HPQ EVA
- Configuring settings for the HPQ EVA
- Global settings for the HPQ EVA
- LU settings for the HPQ EVA
- Host settings for the HPQ EVA

### Changed information

This section lists the updates that were made in this document.

- Support for 4-node configurations has been updated to support 8-node.
- Increased the number of supported VDIs per I/O group to 1024.
- Increased the number of supported VDIs per cluster to 4096.
- Updated support information for split controller configurations.
- Updated the number of uninterruptible power supplies to support up to 8 nodes.
- Updated the maximum configurations.
- Updated configuration examples to include a 8-node configuration.
- Modified the step-by-step instructions for restoring a cluster configuration.
- Updated the Switch zoning limitations for the EMC CLARiiON subsystem.
- Updated the Global settings for the EMC Symmetrix subsystem.
- Updated the Supported models of the IBM FASTT controller.

### Deleted information

No deletions were made in this version of the guide.

#### Related reference

“Summary of Changes” on page xiii

This document contains terminology, maintenance, and editorial changes.

---

## Emphasis

Different typefaces are used in this guide to show emphasis.

The following typefaces are used to show emphasis:

*Table 1. Emphasis descriptions*

<b>Boldface</b>	Text in <b>boldface</b> represents menu items and command names.
<i>Italics</i>	Text in <i>italics</i> is used to emphasize a word. In command syntax, it is used for variables for which you supply actual values, such as a default directory or the name of a cluster.

Table 1. Emphasis descriptions (continued)

Monospace	Text in monospace identifies the data or commands that you type, samples of command output, examples of program code or messages from the system, or names of command flags, parameters, arguments, and name-value pairs.
-----------	---

---

## Numbering conventions

A specific numbering convention is used in this guide and product.

The following numbering conventions are used in this guide and in the product:

- 1 kilobyte (KB) is equal to 1024 bytes
- 1 megabyte (MB) is equal to 1 048 576 bytes
- 1 gigabyte (GB) is equal to 1 073 741 824 bytes
- 1 terabyte (TB) is equal to 1 099 511 627 776 bytes
- 1 petabyte (PB) is equal to 1 125 899 906 842 624 bytes

### Related reference

“About this guide” on page xiii

The IBM TotalStorage SAN Volume Controller Configuration guide provides information that helps you configure and use the IBM® TotalStorage® SAN Volume Controller™.

“Who should use this guide” on page xiii

The IBM TotalStorage SAN Volume Controller Configuration guide is intended for system administrators or others who install and use the SAN Volume Controller.

---

## SAN Volume Controller library and related publications

A list of other publications that are related to this product are provided to you for your reference.

The tables in this section list and describe the following publications:

- The publications that make up the library for the IBM TotalStorage SAN Volume Controller
- Other IBM publications that relate to the SAN Volume Controller

### SAN Volume Controller library

Table 2 on page xvii lists and describes the publications that make up the SAN Volume Controller library. Unless otherwise noted, these publications are available in Adobe portable document format (PDF) on a compact disc (CD) that comes with the SAN Volume Controller. If you need additional copies of this CD, the order number is SK2T-8811. These publications are also available as PDF files from the following Web site:

<http://www-1.ibm.com/servers/storage/support/virtual/2145.html>

Table 2. Publications in the SAN Volume Controller library

<b>Title</b>	<b>Description</b>	<b>Order number</b>
<i>IBM TotalStorage SAN Volume Controller: CIM Agent Developer's Reference</i>	This reference guide describes the objects and classes in a Common Information Model (CIM) environment.	SC26-7590
<i>IBM TotalStorage SAN Volume Controller: Command-Line Interface User's Guide</i>	This guide describes the commands that you can use from the SAN Volume Controller command-line interface (CLI).	SC26-7544
<i>IBM TotalStorage SAN Volume Controller: Configuration Guide</i>	This guide provides guidelines for configuring your SAN Volume Controller.	SC26-7543
<i>IBM TotalStorage SAN Volume Controller: Host Attachment Guide</i>	This guide provides guidelines for attaching the SAN Volume Controller to your host system.	SC26-7575
<i>IBM TotalStorage SAN Volume Controller: Installation Guide</i>	This guide includes the instructions the service representative uses to install the SAN Volume Controller.	SC26-7541
<i>IBM TotalStorage SAN Volume Controller: Planning Guide</i>	This guide introduces the SAN Volume Controller and lists the features you can order. It also provides guidelines for planning the installation and configuration of the SAN Volume Controller.	GA22-1052
<i>IBM TotalStorage SAN Volume Controller: Service Guide</i>	This guide includes the instructions the service representative uses to service the SAN Volume Controller.	SC26-7542
<i>IBM TotalStorage SAN Volume Controller: Translated Safety Notices</i>	This guide contains the danger and caution notices for the SAN Volume Controller. The notices are shown in English and in numerous other languages.	SC26-7577

### Other IBM publications

Table 3 on page xviii lists and describes other IBM publications that contain additional information related to the SAN Volume Controller.

Table 3. Other IBM publications

Title	Description	Order number
<i>IBM TotalStorage Enterprise Storage Server, IBM TotalStorage SAN Volume Controller, IBM TotalStorage SAN Volume Controller for Cisco MDS 9000, Subsystem Device Driver: User's Guide</i>	This guide describes the IBM Subsystem Device Driver Version 1.5 for TotalStorage Products and how to use it with the SAN Volume Controller. This publication is referred to as the <i>IBM TotalStorage Subsystem Device Driver: User's Guide</i> .	SC26-7608

**Related reference**

“How to order IBM publications”

The publications center is a worldwide central repository for IBM product publications and marketing material.

**Related information**

“How to send your comments” on page xix

## Related Web sites

Table 4 lists Web sites that have information about SAN Volume Controller or related products or technologies.

Table 4. Web sites

Type of information	Web site
SAN Volume Controller support	<a href="http://www-1.ibm.com/servers/storage/support/virtual/2145.html">http://www-1.ibm.com/servers/storage/support/virtual/2145.html</a>
Technical support for IBM storage products	<a href="http://www.ibm.com/storage/support/">http://www.ibm.com/storage/support/</a>

## How to order IBM publications

The publications center is a worldwide central repository for IBM product publications and marketing material.

**The IBM publications center**

The IBM publications center offers customized search functions to help you find the publications that you need. Some publications are available for you to view or download free of charge. You can also order publications. The publications center displays prices in your local currency. You can access the IBM publications center through the following Web site:

[www.ibm.com/shop/publications/order/](http://www.ibm.com/shop/publications/order/)

**Publications notification system**

The IBM publications center Web site offers you a notification system for IBM publications. Register and you can create your own profile of publications that interest you. The publications notification system sends you a daily e-mail that contains information about new or revised publications that are based on your profile.

If you want to subscribe, you can access the publications notification system from the IBM publications center at the following Web site:

[www.ibm.com/shop/publications/order/](http://www.ibm.com/shop/publications/order/)

**Related reference**

“SAN Volume Controller library and related publications” on page xvi

A list of other publications that are related to this product are provided to you for your reference.

---

## How to send your comments

Your feedback is important to help us provide the highest quality information. If you have any comments about this book or any other documentation, you can submit them in one of the following ways:

- e-mail

Submit your comments electronically to the following e-mail address:

[starpubs@us.ibm.com](mailto:starpubs@us.ibm.com)

Be sure to include the name and order number of the book and, if applicable, the specific location of the text you are commenting on, such as a page number or table number.

- Mail

Fill out the Readers' Comments form (RCF) at the back of this book. If the RCF has been removed, you can address your comments to:

International Business Machines Corporation  
RCF Processing Department  
Department 61C  
9032 South Rita Road  
Tucson, Arizona 85775-4401  
U.S.A.

**Related reference**

“SAN Volume Controller library and related publications” on page xvi

A list of other publications that are related to this product are provided to you for your reference.



---

## Chapter 1. Overview

This part provides an overview of the SAN Volume Controller.

### Related concepts

“SAN Volume Controller”

The SAN Volume Controller is a SAN appliance that attaches open-systems storage devices to supported open-systems hosts.

### Related reference

“Object overview” on page 9

The SAN Volume Controller is based on a number of virtualization concepts.

“Copy Services” on page 32

There are two types of Copy Service supported by the SAN Volume Controller.

“Configuration rules and requirements” on page 49

Ensure that you understand the rules and requirements when configuring the SAN Volume Controller.

---

## SAN Volume Controller

The SAN Volume Controller is a SAN appliance that attaches open-systems storage devices to supported open-systems hosts.

The IBM® TotalStorage® SAN Volume Controller provides symmetric virtualization by creating a pool of managed disks from the attached storage subsystems, which are then mapped to a set of virtual disks for use by attached host computer systems. System administrators can view and access a common pool of storage on the SAN, which enables them to use storage resources more efficiently and provides a common base for advanced functions.

The SAN Volume Controller is analogous to a logical volume manager (LVM) on a SAN. It performs the following functions for the SAN storage that it is controlling:

- Creates a single pool of storage
- Manages logical volumes
- Provides advanced functions for the SAN, such as:
  - Large scalable cache
  - Copy services
    - Point-in-time Copy
    - FlashCopy® (point-in-time copy)
    - Remote Copy (synchronous copy)
    - Data migration
  - Space management
    - Mapping that is based on desired performance characteristics
    - Quality of service metering

| A *node* is a single storage engine. See Figure 1 on page 2 for a visual of a node.  
| The storage engines are always installed in pairs with one to four pairs of nodes  
| constituting a *cluster*. Each node in a pair is configured to back up the other. Each  
| pair of nodes is known as an *I/O group*. All I/O operations that are managed by the  
| nodes in an I/O group are cached on both nodes for resilience. Each virtual volume

is defined to an I/O group. To avoid any single point of failure, the nodes of an I/O group are protected by independent uninterruptible power supply units.

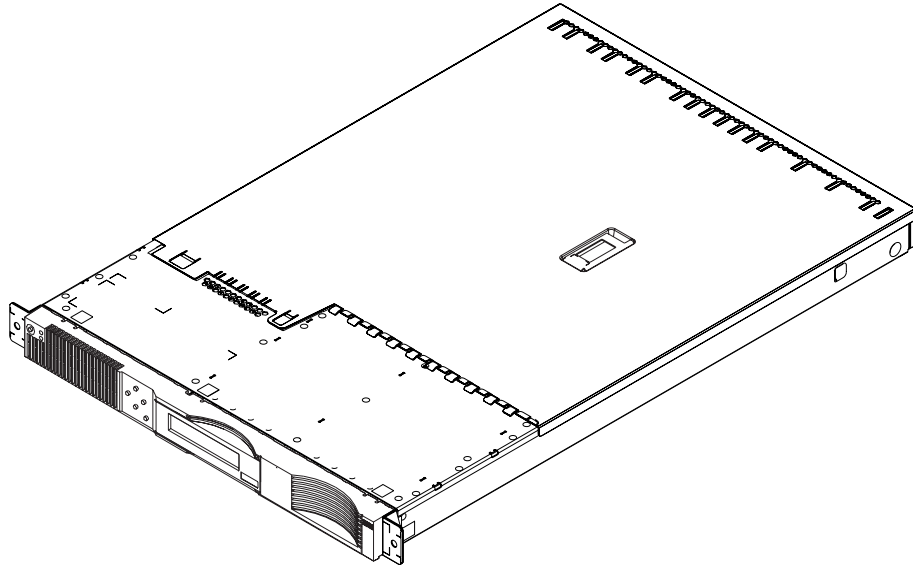

Figure 1. A SAN Volume Controller node

The SAN Volume Controller I/O groups see the storage presented to the SAN by the backend controllers as a number of disks known as *managed disks*. The application services do not see these managed disks. Instead they see a number of logical disks, known as *virtual disks*, that are presented to the SAN by the SAN Volume Controller. Each node must only be in one I/O group and provide access to the virtual disks in the I/O group.

The SAN Volume Controller helps to provide continuous operations and can also optimize the data path to ensure performance levels are maintained. Ensure that you use IBM TotalStorage Multiple Device Manager performance manager to analyze the performance statistics. See *IBM TotalStorage Multiple Device Manager Configuration and Installation Guide* and *IBM TotalStorage Multiple Device Manager CLI Guide* for more information.

The fabric contains two distinct zones: a host zone and a disk zone. In the host zone, the host systems can identify and address the nodes. You can have more than one host zone. Generally, you will create one host zone per operating system type. In the disk zone, the nodes can identify the disk drives. Host systems cannot operate on the disk drives directly; all data transfer occurs through the nodes. As shown in Figure 2 on page 3, several host systems can be connected to a SAN fabric. A cluster of SAN Volume Controllers is connected to the same fabric and presents virtual disks to the host systems. You configure these virtual disks using the disks located on the RAID controllers.

**Note:** You can have more than one host zone. Generally you create one host zone per operating system type because some operating systems will not tolerate other operating systems in the same zone.



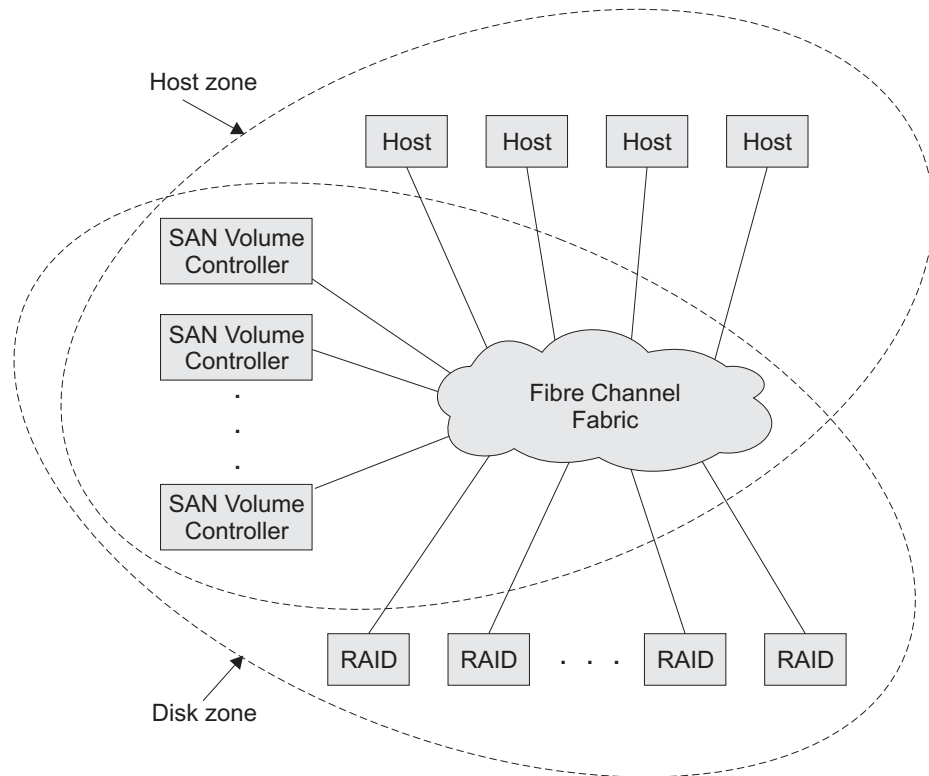

Figure 2. Example of a SAN Volume Controller in a fabric

You can remove one node in each I/O group from a cluster when hardware service or maintenance is required. After you remove the node, you can replace the field replaceable units (FRUs) in the node. All disk drive communication and communication between nodes is performed through the SAN. All SAN Volume Controller configuration and service commands are sent to the cluster through an Ethernet network.

Each node contains its own vital product data (VPD). Each cluster contains VPD that is common to all the nodes on the cluster, and any system connected to the Ethernet network can access this VPD.

Cluster configuration information is stored on every node that is in the cluster to allow concurrent replacement of FRUs. An example of this information might be information that is displayed on the menu screen of the SAN Volume Controller. When a new FRU is installed and when the node is added back into the cluster, configuration information that is required by that node is read from other nodes in the cluster.

### **SAN Volume Controller operating environment**

- Minimum of one pair of SAN Volume Controller nodes
- Minimum two uninterruptible power supplies
- One master console is required per SAN installation for configuration

### **Features of a SAN Volume Controller node**

- 19-inch rack mounted enclosure
- 4 fibre channel ports
- 2 fibre channel adapters

- 4 GB cache memory

### Supported hosts

For a list of supported operating systems, see the IBM TotalStorage SAN Volume Controller Web site at:

<http://www-1.ibm.com/servers/storage/support/virtual/2145.html>

### Multipathing software

- IBM Subsystem Device Driver (SDD)
- Redundant Dual Active Controller (RDAC)

**Note:** Direct attach hosts sharing a back end storage controller with a SAN Volume Controller can run multipath drivers SDD and RDAC. There is no support for the co-existence of native multipath drivers with SDD on the same host.

Check the following Web site for the latest support and coexistence information:

<http://www-1.ibm.com/servers/storage/support/virtual/2145.html>

### User interfaces

The SAN Volume Controller provides the following user interfaces:

- IBM TotalStorage SAN Volume Controller Console, a Web-accessible graphical user interface (GUI) that supports flexible and rapid access to storage management information
- A command-line interface (CLI) using Secure Shell (SSH)

### Application programming interfaces

The SAN Volume Controller provides the following application programming interface:

- IBM TotalStorage Common Information Model (CIM) Agent for the SAN Volume Controller, which supports the Storage Management Initiative Specification of the Storage Network Industry Association.

#### Related concepts

“Virtualization”

Virtualization is a concept that applies to many areas of the information technology industry.

“Asymmetric virtualization” on page 7

With asymmetric virtualization, the virtualization engine is outside the data path and performs a metadata style service. The metadata server contains all the mapping and the locking tables while the storage devices contain only data.

“Symmetric virtualization” on page 8

The SAN Volume Controller provides symmetric virtualization.

## Virtualization

Virtualization is a concept that applies to many areas of the information technology industry.

Where data storage is concerned, virtualization includes the creation of a pool of storage that contains several disk subsystems. These subsystems can be from

various vendors. The pool can be split into virtual disks that are visible to the host systems that use them. Therefore, virtual disks can use mixed back-end storage and provide a common way to manage a storage area network (SAN).

Historically, the term *virtual storage* has described the virtual memory techniques that have been used in operating systems. The term *storage virtualization*, however, describes the shift from managing physical volumes of data to logical volumes of data. This shift can be made on several levels of the components of storage networks. Virtualization separates the representation of storage between the operating system and its users from the actual physical storage components. This technique has been used in mainframe computers for many years through methods such as system-managed storage and products like the IBM Data Facility Storage Management Subsystem (DFSMS). Virtualization can be applied at four main levels:

- Virtualization at the *server* level is performed by managing volumes on the operating systems servers. An increase in the amount of logical storage over physical storage is suitable for environments that do not have storage networks.
- Virtualization at the *storage device* level is in common use. Striping, mirroring, and redundant arrays of independent disks (RAIDs) are used by almost all disk subsystems. This type of virtualization can range from simple RAID controllers to advanced volume management such as that provided by the IBM TotalStorage Enterprise Storage Server (ESS) or by Log Structured Arrays (LSA). The Virtual Tape Server (VTS) is another example of virtualization at the device level.
- Virtualization at the *fabric* level enables storage pools to be independent of the servers and the physical components that make up the storage pools. One management interface can be used to manage different storage systems without affecting the servers. The SAN Volume Controller is used to perform virtualization at the fabric level.
- Virtualization at the *file system* level provides the highest benefit because data is shared, allocated, and protected, not volumes.

Virtualization is a radical departure from traditional storage management. In traditional storage management, storage is attached directly to a host system, which controls storage management. SANs introduced the principle of networks of storage, but storage is still primarily created and maintained at the RAID subsystem level. Multiple RAID controllers of different types require knowledge of, and software that is specific to, the given hardware. Virtualization brings a central point of control for disk creation and maintenance. It brings new ways of handling storage maintenance.

Where storage is concerned, one problematic area that virtualization addresses is that of unused capacity. Rather than individual storage systems remaining islands unto themselves, allowing excess storage capacity to be wasted when jobs do not require it, storage is pooled so that jobs needing the highest storage capacity can use it when they need it. Regulating the amount of storage available becomes easier to orchestrate without computing resource or storage resource having to be turned off and on.

### **Types of virtualization**

Virtualization can be performed either asymmetrically or symmetrically. See Figure 3 on page 6 for more information.

#### **Asymmetric**

A virtualization engine is outside the data path and performs a metadata style service.

## Symmetric

A virtualization engine sits in the data path, presenting disks to the hosts but hiding the physical storage from the hosts. Advanced functions, such as cache and Copy Services, can therefore be implemented in the engine itself.

Virtualization at any level provides benefits. When several levels are combined, however, the benefits of those levels can also be combined. An example of how you can gain the highest benefits is if you attach a low cost RAID controller to a virtualization engine that provides virtual volumes for use by a virtual file system.

**Note:** The SAN Volume Controller implements fabric-level *virtualization*. Within the context of the SAN Volume Controller and throughout this document, *virtualization* refers to symmetric fabric-level virtualization.

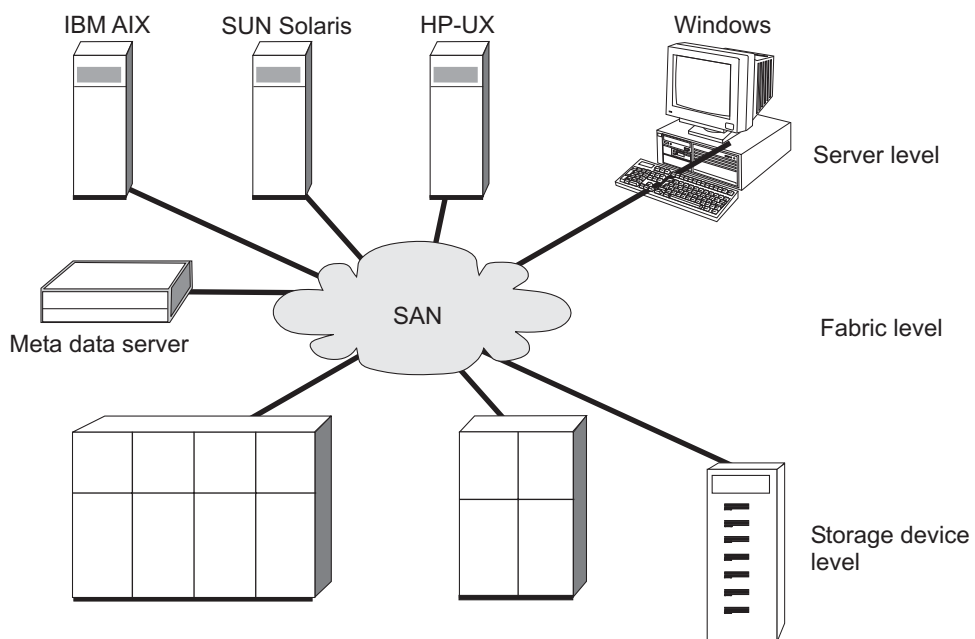

Figure 3. Levels of virtualization

### Related concepts

“Asymmetric virtualization” on page 7

With asymmetric virtualization, the virtualization engine is outside the data path and performs a metadata style service. The metadata server contains all the mapping and the locking tables while the storage devices contain only data.

“Symmetric virtualization” on page 8

The SAN Volume Controller provides symmetric virtualization.

“Virtual disks” on page 26

A *VDisk* is a logical disk that the cluster presents to the storage area network (SAN).

### Related reference

“Configuring and servicing storage subsystems” on page 253

Follow the guidelines and procedures outlined in this section to make the most of the performance available from your storage subsystems and to avoid potential I/O problems.

## Asymmetric virtualization

With asymmetric virtualization, the virtualization engine is outside the data path and performs a metadata style service. The metadata server contains all the mapping and the locking tables while the storage devices contain only data.

In asymmetric virtual storage networks, the data flow, (2) in the figure below, is separated from the control flow, (1). A separate network or SAN link is used for control purposes. The metadata server contains all the mapping and locking tables while the storage devices contain only data. Because the flow of control is separated from the flow of data, I/O operations can use the full bandwidth of the SAN. A separate network or SAN link is used for control purposes. There are disadvantages, however, to asymmetric virtualization.

The disadvantages to asymmetric virtualization include:

- Data is at risk to increased security exposures and the control network must be protected with a firewall.
- Metadata can become very complicated when files are distributed across several devices.
- Each host that accesses the SAN must know how to access and interpret the metadata. Specific device drivers or agent software must therefore be running on each of these hosts.
- The metadata server cannot run advanced functions such as caching or copy services because it only knows about the metadata and not about the data itself. See Figure 4

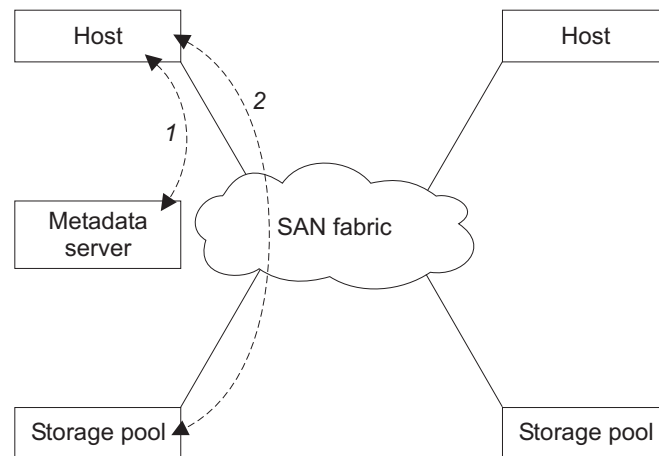

Figure 4. Asymmetrical virtualization

For one, data is at risk to increased security exposures and the control network must be protected with a firewall. In addition, metadata can become very complicated when files are distributed across several devices. Moreover, each host that accesses the SAN must know how to access and interpret the metadata. Specific device driver or agent software must therefore be running on each of these hosts. Finally, the metadata server cannot run advanced functions, such as caching or copy services because it only knows about the metadata and not about the data itself.

### Related concepts

“Symmetric virtualization” on page 8

The SAN Volume Controller provides symmetric virtualization.

## Symmetric virtualization

The SAN Volume Controller provides symmetric virtualization.

Virtualization splits the physical storage Redundant Array of Independent Disks (RAID) arrays into smaller chunks of storage that are known as extents. These extents are then concatenated together, using various policies, to make virtual disks. With symmetric virtualization, host systems can be isolated from the physical storage. Advanced functions, such as data migration, can run without the need to re-configure the host. With symmetric virtualization, the virtualization engine is the central configuration point for the SAN.

In symmetric virtual storage networks (see Figure 5), data and control both flow over the same path. Because the separation of the control from the data occurs in the data path, the storage can be pooled under the control of the virtualization engine. The virtualization engine performs the logical-to-physical mapping.

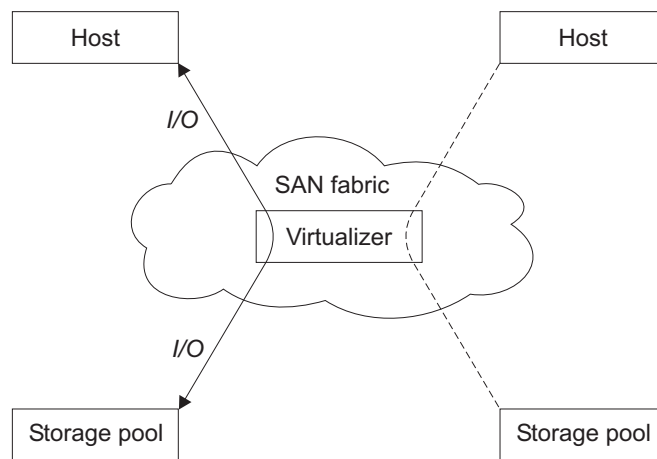

Figure 5. Symmetrical virtualization

The virtualization engine directly controls access to the storage and to the data that is written to the storage. As a result, locking functions that provide data integrity and advanced functions, such as cache and copy services, can be run in the virtualization engine itself. The virtualization engine is, therefore, a central point of control for device and advanced function management. Symmetric virtualization also allows you to build a kind of firewall in the storage network. Only the virtualization engine can give access through the firewall. Symmetric virtualization does, however, cause some problems.

The main problem that is associated with symmetric virtualization is related to poor performance, because all I/O must flow through the virtualization engine. This problem is one of scalability. You can use an n-way cluster of virtualization engines that has failover capacity to solve this problem. You can scale the additional processor power, cache memory, and adapter bandwidth to get the level of performance that you want. The memory and processing power can be used to run the advanced functions, such as copy services and caching.

The IBM TotalStorage SAN Volume Controller uses symmetric virtualization. Single virtualization engines, which are known as nodes, are combined to create clusters. Each cluster can contain between two and eight nodes.

### Related concepts

“Asymmetric virtualization” on page 7

With asymmetric virtualization, the virtualization engine is outside the data path and performs a metadata style service. The metadata server contains all the mapping and the locking tables while the storage devices contain only data.

“Virtualization” on page 4

Virtualization is a concept that applies to many areas of the information technology industry.

---

## Object overview

The SAN Volume Controller is based on a number of virtualization concepts.

A SAN Volume Controller consists of **a single node**. Nodes are deployed in pairs to make up a **cluster**. A cluster can have 1 to 4 node pairs in it. Each pair of nodes is known as an **I/O group**. Each node must be in only one I/O group.

**Virtual disks (VDisks)** are logical disks that are presented to the SAN by nodes. Virtual disks are also associated with an I/O group. The nodes in the I/O group provide access to the virtual disks in the I/O group. When an application server performs I/O to a virtual disk, it has the choice of accessing the virtual disk via either of the nodes in the I/O group. As each I/O group only has two nodes, the distributed cache the SAN Volume Controller provides is only 2-way.

Each node does not contain any internal battery backup units and therefore must be connected to an **Uninterruptible Power Supply (UPS)** to provide data integrity in the event of a cluster-wide power failure. In such situations, the UPS will maintain power to the nodes while the contents of the distributed cache are dumped to an internal drive.

The nodes in a cluster see the storage presented by SAN-attached **storage subsystems** as a number of disks, known as **managed disks (MDisks)**. Because the SAN Volume Controller does not attempt to provide recovery from physical disk failures within the backend disk controllers, a managed disk is usually, but not necessarily, a redundant array of independent disks (RAID) array.

Each managed disk is divided into a number of **extents** (default size is 16MB) which are numbered from 0, sequentially, from the start to the end of the managed disk. The extent size must be specified when creating an MDisk group.

Managed disks are collected into groups, known as **managed disk groups (MDisk groups)**. Virtual disks are created from the extents contained by a managed disk group. The managed disks that constitute a particular virtual disk must all come from the same managed disk group.

At any one time, a single node in the cluster is used to manage configuration activity. This **configuration node** manages a cache of the information that describes the cluster configuration and provides a focal point for configuration.

The SAN Volume Controller detects the Fibre Channel ports that are connected to the SAN. These correspond to the Host Bus Adapter (HBA) Fibre Channels worldwide port names (WWPNs) that are present in the application servers. The SAN Volume Controller allows you to create logical host objects that group together WWPNs belonging to a single application server or multiple application servers.

Application servers can only access virtual disks that have been allocated to them. Virtual disks can be mapped to a host object. The act of mapping a virtual disk to a

host object makes the virtual disk accessible to the WWPNs in that host object, and hence the application server itself.

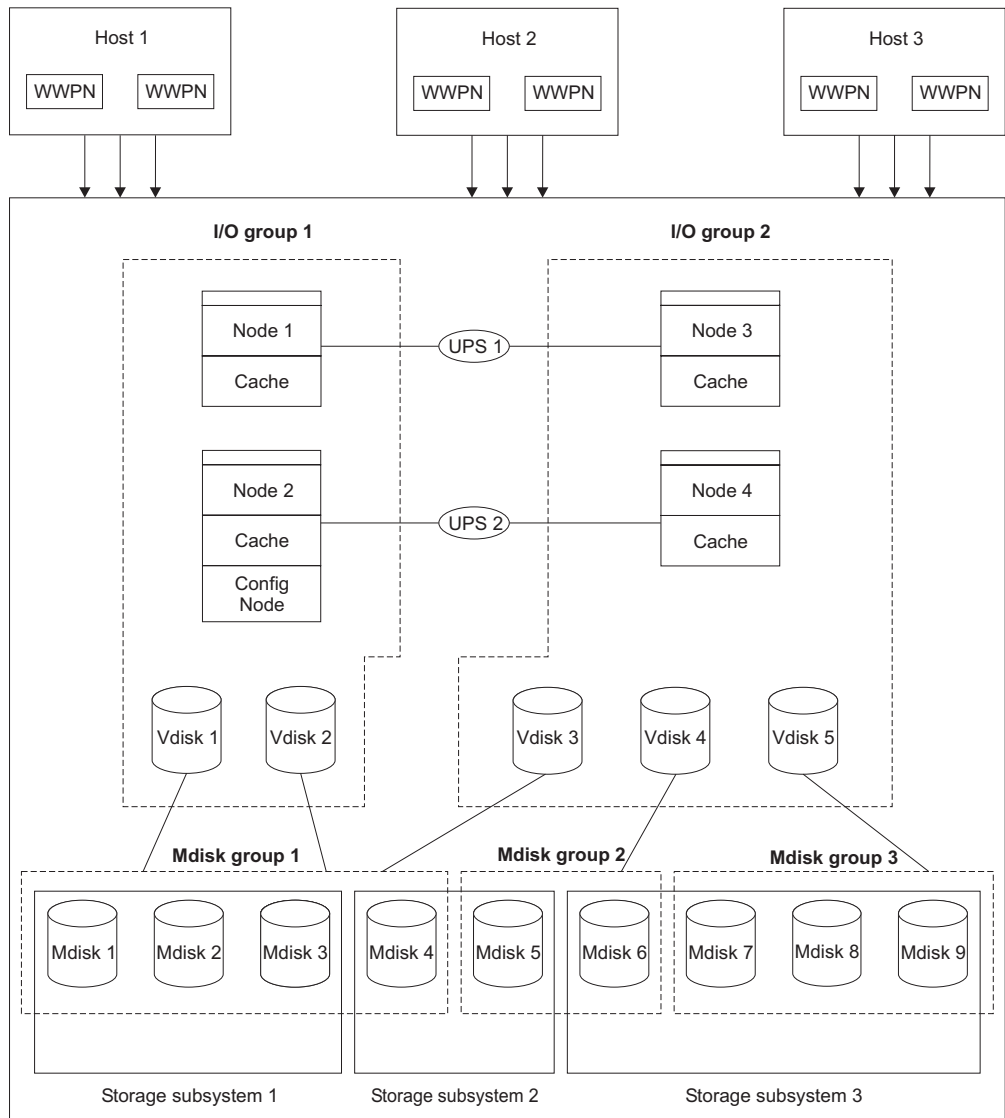

Figure 6. Virtualization

### Related concepts

“Nodes and clusters” on page 11

A SAN Volume Controller node is a single processing unit, which provides virtualization, cache, and copy services for the SAN.

“I/O groups and Uninterruptible Power Supply” on page 15

Nodes are deployed in pairs to make up a cluster. Each pair of nodes is known as an **I/O group**. Each node may be in *only* one I/O group.

“Storage subsystems and managed disks” on page 20

The nodes in a cluster see the storage exported by SAN-attached storage subsystems as a number of disks, known as managed disks. The SAN Volume Controller does not attempt to provide recovery from physical disk failures within the storage subsystem. A managed disk is usually, but not necessarily, a RAID array.



“Managed disk groups and virtual disks (VDisks)” on page 24

Managed disks are collected into groups known as managed disk groups. Virtual disks are logical disks that are presented to the SAN by SAN Volume Controller nodes. The maximum number of supported VDisks per I/O group is 1024. The maximum number of supported VDisks per cluster is 4096. Virtual disks, like nodes, are associated with an I/O group.

“Hosts and virtual (VDisk) mappings” on page 29

Application servers can only access VDisks that have been made accessible to them.

## Nodes and clusters

A SAN Volume Controller node is a single processing unit, which provides virtualization, cache, and copy services for the SAN.

Nodes are deployed in pairs called I/O groups. One node in the cluster is designated the configuration node but each node in the cluster holds a copy of the cluster state information.

### Related concepts

“Clusters”

All configuration and service is performed at the cluster level.

### Related reference

“Nodes” on page 13

A SAN Volume Controller node is a single processing unit within a SAN Volume Controller cluster.

## Clusters

All configuration and service is performed at the cluster level.

A cluster can consist of two nodes, with a maximum of eight nodes. Therefore, you can assign up to eight SAN Volume Controller nodes to one cluster.

Some service actions can be performed at node level, but all configuration is replicated across all nodes in the cluster. Because configuration is performed at the cluster level, an IP address is assigned to the cluster instead of each node.

All your configuration and service actions are performed at the cluster level. Therefore, after configuring your cluster, you can take advantage of the virtualization and the advanced features of the SAN Volume Controller.

### Cluster state and the configuration node

The cluster state holds all configuration and internal cluster data for the cluster. This cluster state information is held in nonvolatile memory. If the mainline power fails, the two uninterruptible power supplies maintain the internal power long enough for the cluster state information to be stored on the internal disk drive of each node. The read and write cache information is also held in nonvolatile memory. Similarly, if the power fails to a node, configuration and cache data for that node will be lost and the partner node attempts to flush the cache. The cluster state is still maintained by the other nodes on the cluster.

Figure 7 on page 12 shows an example cluster containing four nodes. The cluster state shown in the grey box does not actually exist, instead each node holds a copy of the entire cluster state.

The cluster contains a single node that is elected as the configuration node. The configuration node can be thought of as the node that controls the updating of cluster state. For example, a user request is made (item 1), that results in a change being made to the configuration. The configuration node controls updates to the cluster (item 2). The configuration node then forwards the change to all nodes (including Node 1), and they all make the state-change at the same point in time (item 3). Using this state-driven model of clustering ensures that all nodes in the cluster know the exact cluster state at any one time.

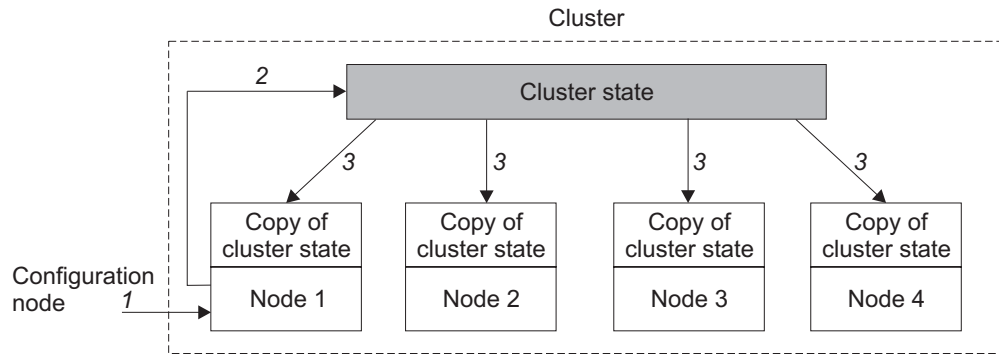

Figure 7. Cluster, nodes, and cluster state.

### **Cluster configuration backup:**

Configuration backup is the process of extracting configuration data from a cluster and writing it to disk.

Backing up the cluster configuration enables you to restore it in the event that configuration data is lost. The data that is backed up is the metadata that describes the cluster configuration, not the data that your enterprise uses to run its business.

The backup configuration files can be saved on the master console or the configuration node.

### **Objects included in the backup**

Configuration data is information about a cluster and the objects that are defined in it. The following objects are copied:

- Storage subsystem
- Hosts
- I/O groups
- Managed disks (MDisks)
- MDisk groups
- Nodes
- Virtual disks (VDisks)
- VDisk-to-host mappings
- SSH key
- FlashCopy mappings
- FlashCopy consistency groups
- Remote Copy relationships
- Remote Copy consistency groups

### Related concepts

“Clusters” on page 11

All configuration and service is performed at the cluster level.

“Configuration restore”

Configuration restore is the process of using a backup configuration file, or files, on the master console or configuration node to restore a specific cluster configuration.

### **Configuration restore:**

Configuration restore is the process of using a backup configuration file, or files, on the master console or configuration node to restore a specific cluster configuration.

Restoring your cluster configuration involves restoring the metadata that describes your cluster configuration, not the data your enterprise uses to run its business. Restoring your cluster configuration is an important part of a complete backup and disaster recovery solution. However, you must make provision for your non-configuration data to be restored as well.

This process consists of two phases:

- Preparing
- Executing

### Restore phases

Before issuing the preparation command, or phase, the cluster itself must be reset to a default state with the correct cluster name. During the preparation phase, the backup data and the new cluster are analyzed for compatibility, and a sequence of commands is prepared.

During the execution phase, the command sequence is run.

### Related concepts

“Clusters” on page 11

All configuration and service is performed at the cluster level.

Chapter 5, “Backing up and restoring the cluster configuration,” on page 231  
You can back up and restore the cluster configuration.

“Cluster configuration backup” on page 12

Configuration backup is the process of extracting configuration data from a cluster and writing it to disk.

### Nodes

A SAN Volume Controller node is a single processing unit within a SAN Volume Controller cluster.

For redundancy, nodes are deployed in pairs to make up a cluster. A cluster can have one to four pairs of nodes in it. Each pair of nodes is known as an I/O group. Each node can be in *only* one I/O group. A maximum of four I/O groups each containing two nodes is supported.

At any one time, a single node in the cluster is used to manage configuration activity. This configuration node manages a cache of the configuration information that describes the cluster configuration and provides a focal point for configuration commands. If the configuration node fails, another node in the cluster will take over its responsibilities.

Table 5 describes the operational states of a node.

Table 5. Node state

State	Description
<b>Adding</b>	The node was added to the cluster but is not yet synchronized with the cluster state (see Note).
<b>Deleting</b>	The node is in the process of being deleted from the cluster.
<b>Online</b>	The node is operational, assigned to a cluster, and has access to the fibre-channel SAN fabric.
<b>Offline</b>	The node is not operational. The node was assigned to a cluster but is not available on the fibre-channel SAN fabric. Run the Directed Maintenance Procedures to determine the problem.
<b>Pending</b>	The node is transitioning between states and, in a few seconds, will move to one of the other states.
<b>Note:</b> It is possible that a node can stay in the Adding state for a long time. If this is the case, delete the node and then re-add it. However, you should wait for at least 30 minutes before doing this. If the node that has been added is at a lower code level than the rest of the cluster, the node will be upgraded to the cluster code level, which can take up to 20 minutes. During this time the node will be shown as adding.	

#### **Related concepts**

“Configuration node”

At any given time, one node manages configuration activity. This node is the *configuration node*.

#### **Configuration node:**

At any given time, one node manages configuration activity. This node is the *configuration node*.

The configuration node is a focal point for configuration commands, and it manages the data that describes the cluster configuration.

If the configuration node fails, the cluster chooses a new configuration node. This action is called configuration node failover. The switch that contains the new node takes over the cluster IP address. Thus you can access the cluster through the same IP address although the original configuration node has failed. During the failover, there is a short period when you cannot use the command line tools or SAN Volume Controller Console.

The figure below shows an example cluster containing four nodes. Node 1 has been designated the configuration node. User requests (1) are targeted at Node 1. This may result in requests (2) being targeted at the other nodes in the cluster, and data being returned to Node 1. See Figure 8 on page 15 for more information.

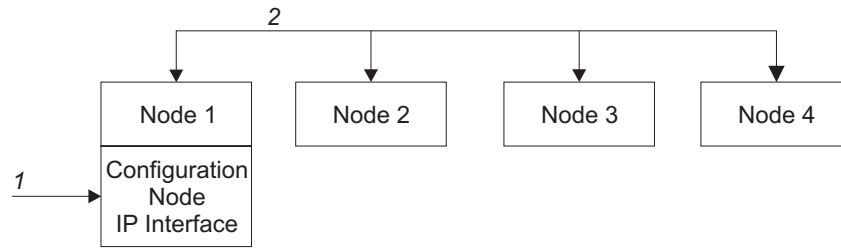

Figure 8. Configuration node

#### Related reference

“Nodes” on page 13

A SAN Volume Controller node is a single processing unit within a SAN Volume Controller cluster.

## I/O groups and Uninterruptible Power Supply

Nodes are deployed in pairs to make up a cluster. Each pair of nodes is known as an **I/O group**. Each node may be in *only* one I/O group.

Virtual disks are logical disks that are presented to the SAN by SAN Volume Controller nodes. Virtual disks are also associated with an I/O group. The SAN Volume Controller does not contain any internal battery backup units and therefore must be connected to an uninterruptible power supply to provide data integrity in the event of a cluster wide power failure.

### Input/Output (I/O) groups

An I/O group is a group that is defined during the cluster configuration process.

It usually contains two SAN Volume Controller nodes for availability purposes. However, depending on the configuration, an I/O group may be empty or just contain a single node. Each node is associated with only one I/O group, and each virtual disk (VDisk) is associated with only one I/O group. The nodes in the I/O group provide access to the VDIs in the I/O group.

When an application server performs I/O to a virtual disk, it has the choice of accessing the virtual disk via either of the nodes in the I/O group. A virtual disk can specify a preferred node. This is specified when the virtual disk is created. This is the node through which a virtual disk should normally be accessed. As each I/O group only has two nodes, the distributed cache in the SAN Volume Controller need only be 2-way. When I/O is performed to a virtual disk, the node that processes the I/O duplicates the data onto the partner node that is in the I/O group.

I/O traffic for a particular virtual disk is, at any one time, handled exclusively by the nodes in a single I/O group. Thus, although a cluster may have many nodes within it, the nodes handle I/O in independent pairs. This means that the I/O capability of the SAN Volume Controller scales well, since additional throughput can be obtained by adding additional I/O groups.

A write operation from a host is shown (item 1), that is targeted for virtual disk A. This write is targeted at the preferred node, Node 1 (item 2). The write is cached and a copy of the data is made in the partner node, Node 2’s cache (item 3). The write is now complete, so far as the host is concerned. At some later time, the data is written, or destaged, to storage (item 4). The figure also shows two

uninterruptible power supplies (1 and 2) correctly configured so that each node is in a different power domain.

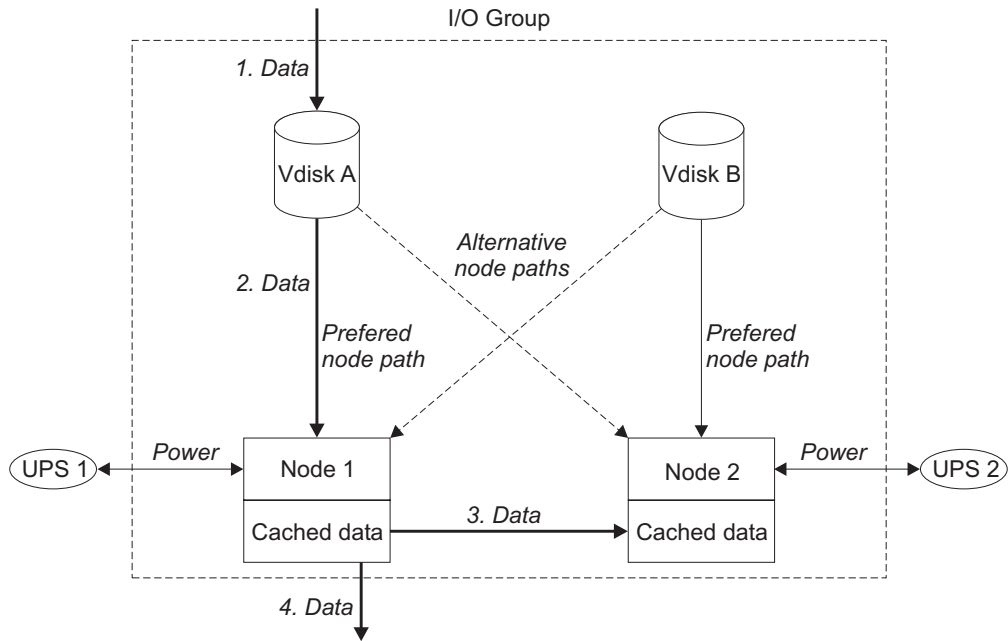

Figure 9. I/O group and uninterruptible power supply

When a node fails within an I/O group, the other node in the I/O group will take over the I/O responsibilities of the failed node. Data loss during a node failure is prevented by mirroring the I/O read/write data cache between the two nodes in an I/O group.

If only one node is assigned to an I/O group, or a node has failed in an I/O group, the cache is flushed to the disk and then goes into write-through mode. Therefore, any writes for the virtual disks that are assigned to this I/O group are not cached; it is sent directly to the storage device. If both nodes in an I/O group go offline, the virtual disks that are assigned to the I/O group cannot be accessed.

When a virtual disk is created, the I/O group that will provide access to the virtual disk must be specified. However, virtual disks can be created and added to I/O groups that contain offline nodes. I/O access will not be possible until at least one of the nodes in the I/O group is online.

The cluster also provides a **recovery I/O group**. This is used when both nodes in the I/O group have suffered multiple failures. This allows you to move the virtual disks to the recovery I/O group and then into a working I/O group. I/O access is not possible when virtual disks are assigned to the recovery I/O group.

#### Related concepts

“Input/Output (I/O) groups” on page 15

An I/O group is a group that is defined during the cluster configuration process.

“Uninterruptible power supply overview” on page 17

The uninterruptible power supply provides the SAN Volume Controller with a secondary power source to be used if you lose power from your primary power source due to power failures, power sags, power surges, or line noise.

“I/O groups and Uninterruptible Power Supply” on page 15

Nodes are deployed in pairs to make up a cluster. Each pair of nodes is known as an **I/O group**. Each node may be in *only* one I/O group.

### Uninterruptible power supply overview

The uninterruptible power supply provides the SAN Volume Controller with a secondary power source to be used if you lose power from your primary power source due to power failures, power sags, power surges, or line noise.

If a power outage occurs, the uninterruptible power supply will maintain power long enough to save any configuration and cache data contained in the dynamic random access memory (DRAM). The data will be saved to the SAN Volume Controller internal disk. Figure 10 provides a visual of the uninterruptible power supply.

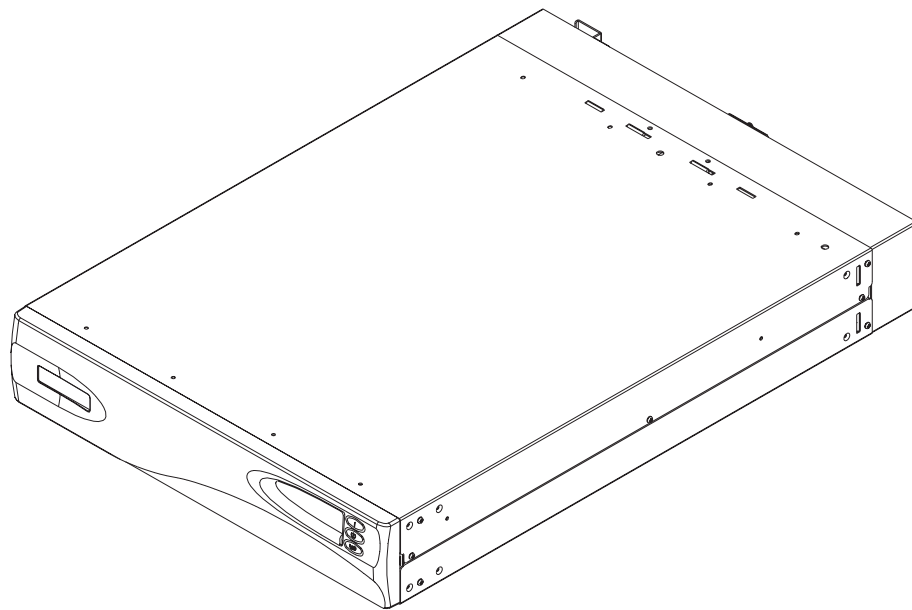

Figure 10. Uninterruptible power supply

**Note:** The SAN Volume Controller uninterruptible power supply is an integral part of the SAN Volume Controller solution, and maintains continuous SAN Volume Controller specific communications with its attached SAN Volume Controller nodes. The SAN Volume Controller will not operate without the uninterruptible power supply. The SAN Volume Controller uninterruptible power supply must be used in accordance with documented guidelines and procedures and must not power any equipment other than SAN Volume Controller nodes.

To provide full redundancy and concurrent maintenance, the SAN Volume Controller must be installed in pairs. Each SAN Volume Controller of a pair must be connected to a different uninterruptible power supply. Each uninterruptible power supply can support up to two SAN Volume Controller nodes. It is also recommended that you connect the two uninterruptible power supply units for the pair to different independent electrical power sources. This reduces the chance of an input power failure at both uninterruptible power supply units.

The uninterruptible power supply must be in the same rack as the nodes. When using 6 or 8 node support, ensure that 4 uninterruptible power supplies are used. Ensure that you are following the uninterruptible power supply support guidelines as described below:

Number of nodes	Number of uninterruptible power supplies
2	2
4	2
6	4
8	4

**Attention:**

1. Do not connect the uninterruptible power supplies to an input power source that does not conform to standards. Review the requirements for uninterruptible power supplies listed under "Related reference" at the end of this topic.
2. Each uninterruptible power supply pair must power only one SAN Volume Controller cluster.

Each uninterruptible power supply includes power (line) cords that will connect the uninterruptible power supply to either a rack power distribution unit (PDU), if one exists, or to an external power source. Each uninterruptible power supply power input requires the protection of a UL approved (or equivalent) 250 volt, 15 amp circuit breaker.

The uninterruptible power supply is connected to the SAN Volume Controllers with a power cable and a signal cable. To avoid the possibility of power and signal cables being connected to different uninterruptible power supply units, these cables are wrapped together and supplied as a single field replaceable unit. The signal cables enable the SAN Volume Controllers to read status and identification information from the uninterruptible power supply.

Each SAN Volume Controller monitors the operational state of the uninterruptible power supply to which it is attached. If the uninterruptible power supply reports a loss of input power, the SAN Volume Controller stops all I/O operations and dumps the contents of its DRAM to the internal disk drive. When input power to the uninterruptible power supply is restored, the SAN Volume Controllers restart and restore the original contents of the DRAM from the data saved on the disk drive.

A SAN Volume Controller is not fully operational until the uninterruptible power supply battery charge state indicates that it has sufficient capacity to power the SAN Volume Controller for long enough to permit it to save all its memory to the disk drive in the event of a power loss. The uninterruptible power supply has sufficient capacity to save all the data on the SAN Volume Controller at least twice. For a fully-charged uninterruptible power supply, even after battery capacity has been used to power the SAN Volume Controllers while they save DRAM data, sufficient battery capacity will remain to let the SAN Volume Controllers become fully operational as soon as input power is restored.

**Note:** Under normal circumstances, if input power is disconnected from the uninterruptible power supply, the SAN Volume Controller(s) connected to that uninterruptible power supply will perform a power down sequence. This operation, which saves the configuration and cache data to an internal disk



in the SAN Volume Controller, typically takes about three minutes, at which time power is removed from the output of the uninterruptible power supply. In the event of a delay in the completion of the power down sequence, the uninterruptible power supply output power will be removed five minutes after the time that power was disconnected to the uninterruptible power supply. Since this operation is controlled by the SAN Volume Controller, an uninterruptible power supply that is not connected to an active SAN Volume Controller will not shut off within the five-minute required period. In the case of an emergency, you will need to manually shut down the uninterruptible power supply by pushing the uninterruptible power supply power off button.

**Attention:** Data integrity could be compromised by pushing the uninterruptible power supply power off button. Never shut down an uninterruptible power supply without first shutting down the SAN Volume Controller nodes that it supports.

It is very important that the two nodes in the I/O group are connected to different uninterruptible power supplies. This configuration ensures that cache and cluster state information is protected in the event of a failure of the uninterruptible power supply or mainline power source.

When nodes are added to the cluster, you must specify the I/O group they will join. The configuration interfaces will also check the uninterruptible power supply units and ensure that the two nodes in the I/O group are not connected to the same uninterruptible power supply units.

Figure 11 shows a cluster of four nodes, with two I/O groups and two uninterruptible power supply units.

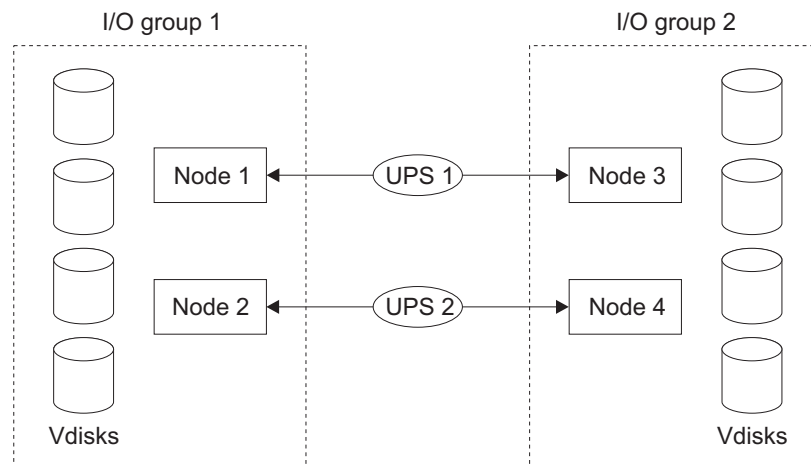

Figure 11. I/O groups and uninterruptible power supply relationship

### Related concepts

“Input/Output (I/O) groups” on page 15

An I/O group is a group that is defined during the cluster configuration process.

“I/O groups and Uninterruptible Power Supply” on page 15

Nodes are deployed in pairs to make up a cluster. Each pair of nodes is known as an **I/O group**. Each node may be in *only* one I/O group.

## Storage subsystems and managed disks

The nodes in a cluster see the storage exported by SAN-attached storage subsystems as a number of disks, known as managed disks. The SAN Volume Controller does not attempt to provide recovery from physical disk failures within the storage subsystem. A managed disk is usually, but not necessarily, a RAID array.

### Related concepts

“Storage subsystems”

A storage subsystem is a device that coordinates and controls the operation of one or more disk drives and synchronizes the operation of the drives with the operation of the system as a whole.

“Managed disks” on page 21

A managed disk (MDisk) is a logical disk (typically a RAID array or partition thereof) that a storage subsystem has exported to the SAN fabric to which the nodes in the cluster are attached.

### Storage subsystems

A storage subsystem is a device that coordinates and controls the operation of one or more disk drives and synchronizes the operation of the drives with the operation of the system as a whole.

Storage subsystems attached to the SAN fabric provide the physical storage devices that the cluster detects as managed disks. These are usually RAID arrays, because the SAN Volume Controller does not attempt to provide recovery from physical disk failures within the storage subsystem. The nodes in the cluster are connected to one or more fibre-channel SAN fabrics.

The exported storage devices are detected by the cluster and reported by the user interfaces. The cluster can also determine which managed disks each storage subsystem is presenting, and can provide a view of managed disks filtered by the storage subsystem. This allows you to associate the managed disks with the RAID arrays that the subsystem exports.

The storage subsystem may have a local name for the RAID arrays or single disks that it is providing. However it is not possible for the nodes in the cluster to determine this name, because the namespace is local to the storage subsystem. The storage subsystem will surface these storage devices with a unique ID, the logical unit number (LUN). This ID, along with the storage subsystem serial number or numbers (there may be more than one controller in a storage subsystem), can be used to associate the managed disks in the cluster with the RAID arrays exported by the subsystem.

Storage subsystems export storage to other devices on the SAN. The physical storage associated with a subsystem is normally configured into RAID arrays that provide recovery from physical disk failures. Some subsystems also allow physical storage to be configured as RAID-0 arrays (striping) or as JBODs. However, this does not provide protection against a physical disk failure and, with virtualization, can lead to the failure of many virtual disks.

Many storage subsystems allow the storage provided by a RAID array to be divided up into many SCSI logical units (LUs) that are presented on the SAN. With the SAN Volume Controller it is recommended that storage subsystems are configured to present each RAID array as a single SCSI LU that will be recognized by the SAN Volume Controller as a single managed disk. The virtualization features of the SAN Volume Controller can then be used to divide up the storage into virtual disks.

Some storage subsystems allow the exported storage to be increased in size. The SAN Volume Controller will not use this extra capacity. Instead of increasing the size of an existing managed disk, a new managed disk should be added to the managed disk group and the extra capacity will be available for the SAN Volume Controller to use.

**Attention:** If you delete a RAID that is being used by the SAN Volume Controller, the MDisk group will go offline and the data in that group will be lost.

When configuring your storage subsystems, ensure that you configure and manage your subsystems and its devices for optimal performance.

The cluster detects and provides a view of the storage subsystems that the SAN Volume Controller supports. The cluster can also determine which MDisks each subsystem has and can provide a view of MDisks filtered by device. This view enables you to associate the MDisks with the RAID arrays that the subsystem presents.

**Note:** The SAN Volume Controller Console supports storage that is internally configured as a RAID array. However, it is possible to configure a storage subsystem as a non-RAID device. RAID provides redundancy at the disk level. For RAID devices, a single physical disk failure does not cause an MDisk failure, an MDisk group failure, or a failure in the virtual disks (VDisks) that were created from the MDisk group.

Storage subsystems reside on the SAN fabric and are addressable by one or more fibre-channel ports (target ports). Each port has a unique name known as a worldwide port name (WWPN).

#### **Related concepts**

“Managed disks”

A managed disk (MDisk) is a logical disk (typically a RAID array or partition thereof) that a storage subsystem has exported to the SAN fabric to which the nodes in the cluster are attached.

“Storage subsystems and managed disks” on page 20

The nodes in a cluster see the storage exported by SAN-attached storage subsystems as a number of disks, known as managed disks. The SAN Volume Controller does not attempt to provide recovery from physical disk failures within the storage subsystem. A managed disk is usually, but not necessarily, a RAID array.

#### **Managed disks**

A managed disk (MDisk) is a logical disk (typically a RAID array or partition thereof) that a storage subsystem has exported to the SAN fabric to which the nodes in the cluster are attached.

A managed disk might, therefore, consist of multiple physical disks that are presented as a single logical disk to the SAN. A managed disk always provides usable blocks of physical storage to the cluster even if it does not have a one-to-one correspondence with a physical disk.

Each managed disk is divided into a number of *extents*, which are numbered, from 0, sequentially from the start to the end of the managed disk. The extent size is a property of managed disk groups. When an MDisk is added to an MDisk group, the size of the extents that the MDisk will be broken into depends on the attribute of the MDisk group to which it has been added.

## Access modes

The access mode determines how the cluster uses the MDisk. The possible modes are:

### Unmanaged

The MDisk is not used by the cluster.

### Managed

The MDisk is assigned to an MDisk group and is providing extents that virtual disks (VDisks) can use.

**Image** The MDisk is assigned directly to a VDisk with a one-to-one mapping of extents between the MDisk and the VDisk.

**Attention:** If you add a managed disk that contains existing data to a managed disk group, you will lose the data that it contains. The *image mode* is the only mode that will preserve this data.

Figure 12 shows physical disks and managed disks.

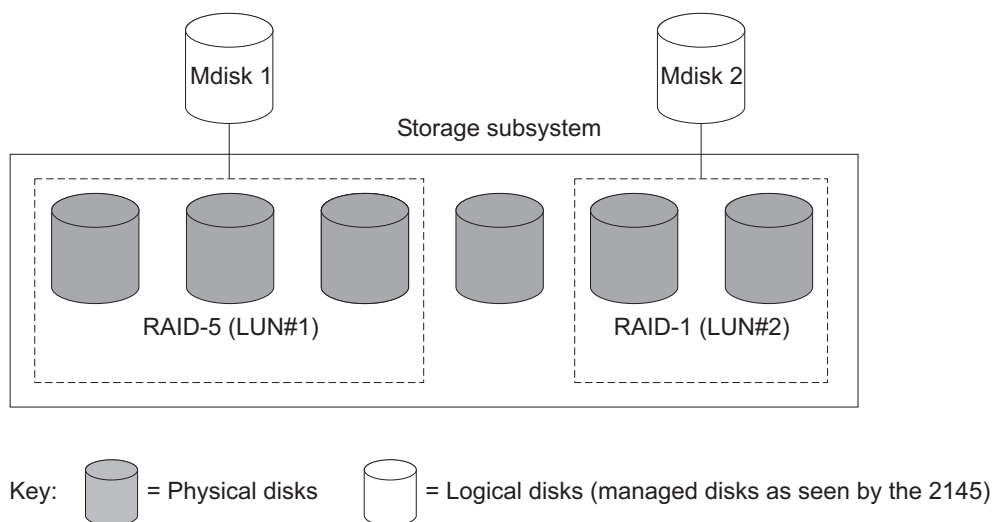

Figure 12. Controllers and MDisks

Table 6 describes the operational states of a managed disk:

Table 6. Managed disk status

Status	Description
Online	<p>The MDisk can be accessed by all online nodes. That is, all the nodes that are currently working members of the cluster can access this MDisk. The MDisk is online when the following conditions are met:</p> <ul style="list-style-type: none"> <li>• All timeout error recovery procedures complete and report the disk as online.</li> <li>• LUN inventory of the target ports correctly reported the MDisk.</li> <li>• Discovery of this LUN completed successfully.</li> <li>• All of the managed disk target ports report this LUN as available with no fault conditions.</li> </ul>

Table 6. Managed disk status (continued)

Degraded	The MDisk cannot be accessed by all the online nodes. That is, one or more (but not all) of the nodes that are currently working members of the cluster cannot access this MDisk. The MDisk may be partially excluded; that is, some of the paths to the MDisk (but not all) have been excluded.
Excluded	The MDisk has been excluded from use by the cluster after repeated access errors. Run the Directed Maintenance Procedures to determine the problem. You can reset an MDisk and include it in the cluster again by running the <b>svctask includemdisk</b> command.
Offline	The MDisk cannot be accessed by any of the online nodes. That is, all of the nodes that are currently working members of the cluster cannot access this MDisk. This state can be caused by a failure in the SAN, the storage subsystem, or one or more physical disks connected to the storage subsystem. The MDisk will only be reported as offline if all paths to the disk fail.

## Extents

Each MDisk is divided into chunks of equal size called *extents*. Extents are a unit of mapping the data between MDisks and virtual disks (VDisks).

**Attention:** If your fabric is undergoing transient link breaks or you have been replacing cables or connections in your fabric, you might see one or more MDisks change to the degraded status. If an I/O operation was attempted during the link breaks and the same I/O failed several times, the MDisk will be partially excluded and will change to a status of degraded. You should include the MDisk to resolve the problem. You can include the MDisk by either selecting the Include MDisk task from the Work with Managed Disks - Managed Disk panel in the SAN Volume Controller Console, or issue the following command:

```
svctask includemdisk <mdiskname/id>
```

**Managed disk path** Each managed disk will have an online path count, which is the number of nodes that have access to that managed disk; this represents a summary of the I/O path status between the cluster nodes and the particular storage device. The maximum path count is the maximum number of paths that have been detected by the cluster at any point in the past. Thus if the current path count is not equal to the maximum path count then the particular managed disk may be degraded. That is, one or more nodes may not see the managed disk on the fabric.

### Related concepts

“Storage subsystems” on page 20

A storage subsystem is a device that coordinates and controls the operation of one or more disk drives and synchronizes the operation of the drives with the operation of the system as a whole.

“Storage subsystems and managed disks” on page 20

The nodes in a cluster see the storage exported by SAN-attached storage subsystems as a number of disks, known as managed disks. The SAN Volume

Controller does not attempt to provide recovery from physical disk failures within the storage subsystem. A managed disk is usually, but not necessarily, a RAID array.

## Managed disk groups and virtual disks (VDisks)

Managed disks are collected into groups known as managed disk groups. Virtual disks are logical disks that are presented to the SAN by SAN Volume Controller nodes. The maximum number of supported VDisks per I/O group is 1024. The maximum number of supported VDisks per cluster is 4096. Virtual disks, like nodes, are associated with an I/O group.

Virtual disks are created from the extents of managed disks. Only managed disks that are in the same managed disk group can contribute extents to a virtual disk.

### Related concepts

“Managed disk groups”

An *MDisk group* is a collection of MDisks that jointly contain all the data for a specified set of virtual disks (VDisks).

“Virtual disks” on page 26

A *VDisk* is a logical disk that the cluster presents to the storage area network (SAN).

### Managed disk groups

An *MDisk group* is a collection of MDisks that jointly contain all the data for a specified set of virtual disks (VDisks).

All MDisks in a group are split into extents of the same size. VDisks are created from the extents that are available in the group. You can add MDisks to an MDisk group at any time. This way you increase the number of extents that are available for new VDisks or to expand existing VDisks.

**Note:** RAID array partitions on HP StorageWorks subsystems controllers are only supported in single-port attach mode. MDisk groups that consist of single-port attached subsystems and other storage subsystems are not supported.

You can add MDisks to an MDisk group at any time either to increase the number of extents that are available for new VDisks or to expand existing VDisks. You can add only MDisks that are in unmanaged mode. When MDisks are added to a group, their mode changes from unmanaged to managed.

You can delete MDisks from a group under the following conditions:

- VDisks are not using any of the extents that are on the MDisk.
- Enough free extents are available elsewhere in the group to move any extents that are in use from this MDisk.

**Attention:** If you delete an MDisk group, you destroy all the VDisks that are made from the extents that are in the group. If the group is deleted, you cannot recover the mapping that existed between extents that are in the group and the extents that VDisks use. The MDisks that were in the group are returned to unmanaged mode and can be added to other groups. Because the deletion of a group can cause a loss of data, you must force the deletion if VDisks are associated with it.

Table 7 describes the operational states of an MDisk group.

Table 7. Managed disk group status

Status	Description
<b>Online</b>	The MDisk group is online and available. All the MDisks in the group are available.
<b>Degraded</b>	The MDisk group is available; however, one or more nodes cannot access all the MDisks in the group.
<b>Offline</b>	The MDisk group is offline and unavailable. No nodes in the cluster can access the MDisks. The most likely cause is that one or more MDisks are offline or excluded.

**Attention:** If a single MDisk in an MDisk group is offline and therefore cannot be seen by any of the online nodes in the cluster, then the MDisk group of which this MDisk is a member goes offline. This causes *all* the VDIs that are being presented by this MDisk group to go offline. Care should be taken when creating MDisk groups to ensure an optimal configuration.

Consider the following guidelines when you create MDisk groups:

- If you are creating image-mode VDIs, do not put all of these VDIs into one MDisk group because a single MDisk failure results in all of these VDIs going offline. Allocate your image-mode VDIs between your MDisk groups.
- Ensure that all MDisks that are allocated to a single MDisk group are the same RAID type. This ensures that a single failure of a physical disk in the storage subsystem does not take the entire group offline. For example, if you have three RAID-5 arrays in one group and add a non-RAID disk to this group, then you lose access to all the data striped across the group if the non-RAID disk fails. Similarly, for performance reasons you should not mix RAID types. The performance of all VDIs will be reduced to the lowest performer in the group.
- If you intend to keep the virtual disk allocation within the storage exported by a storage subsystem, ensure that the MDisk group that corresponds with a single subsystem is presented by that subsystem. This also enables nondisruptive migration of data from one subsystem to another subsystem and simplifies the decommissioning process if you want to decommission a controller at a later time.
- Except when migrating between groups, a VDI must be associated with just one MDisk group.
- An MDisk can be associated with just one MDisk group.

### Extent

To track the space that is available, the SAN Volume Controller divides each MDisk in an MDisk group into chunks of equal size. These chunks are called *extents*, and are indexed internally. Extent sizes can be 16, 32, 64, 128, 256, or 512 MB.

You must specify the extent size when you create a new MDisk group. You cannot change the extent size later; it must remain constant throughout the lifetime of the MDisk group. MDisk groups can have different extent sizes. However, different extent sizes can place restrictions on the use of data migration. The choice of extent size affects the total amount of storage that can be managed by a SAN Volume Controller cluster. Table 8 on page 26 shows the maximum amount of

storage that can be managed by a cluster for each extent size. Because the SAN Volume Controller allocates a whole number of extents to each virtual disk that is created, using a larger extent size can increase the amount of wasted storage at the end of each virtual disk. Larger extent sizes also reduce the ability of the SAN Volume Controller to distribute sequential I/O workloads across many managed disks. Therefore, larger extent sizes might reduce the performance benefits of virtualization.

Table 8. Capacities of the cluster given extent size

Extent size	Maximum storage capacity of cluster
16 MB	64 TB
32 MB	128 TB
64 MB	256 TB
128 MB	512 TB
256 MB	1 PB
512 MB	2 PB

Figure 13 shows an MDisk group containing four MDisks.

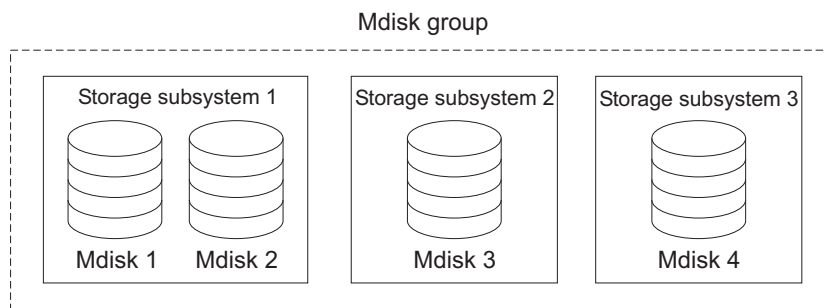

Figure 13. MDisk group

### Related concepts

“Virtual disks”

A *VDisk* is a logical disk that the cluster presents to the storage area network (SAN).

“Managed disk groups and virtual disks (VDisks)” on page 24

Managed disks are collected into groups known as managed disk groups. Virtual disks are logical disks that are presented to the SAN by SAN Volume Controller nodes. The maximum number of supported VDisks per I/O group is 1024. The maximum number of supported VDisks per cluster is 4096. Virtual disks, like nodes, are associated with an I/O group.

### Virtual disks

A *VDisk* is a logical disk that the cluster presents to the storage area network (SAN).

Application servers on the SAN access VDisks, not managed disks (MDisks). VDisks are created from a set of extents in an MDisk group. There are three types of VDisks: striped, sequential, and image.



## Types

You can create the following types of VDisks:

### Striped

The striping is at extent level. One extent is allocated, in turn, from each managed disk that is in the group. For example, a managed disk group that has 10 MDisks takes one extent from each managed disk. The 11th extent is taken from the first managed disk, and so on. This procedure, known as a round-robin, is similar to RAID-0 striping.

You can also supply a list of MDisks to use as the stripe set. This list can contain two or more MDisks from the managed disk group. The round-robin procedure is used across the specified stripe set.

**Attention:** Care should be taken when specifying a stripe set if your MDisk group contains MDisks of unequal size. By default striped VDisks are striped across all MDisks in the group. If some of the MDisks are smaller than others, the extents on the smaller MDisks will be used up before the larger MDisks run out of extents. Manually specifying the stripe set in this case might result in the VDisk not being created.

If you are unsure about whether there is sufficient free space to create a striped VDisk select one of the following options:

- Check the free space on each MDisk in the group, using the **svcinfolsfreeextents** command
- Let the system automatically create the VDisk, by not supplying a specific stripe set.

Figure 14 shows an example of a managed disk group containing three MDisks. This figure also shows a striped virtual disk created from the extents available in the group.

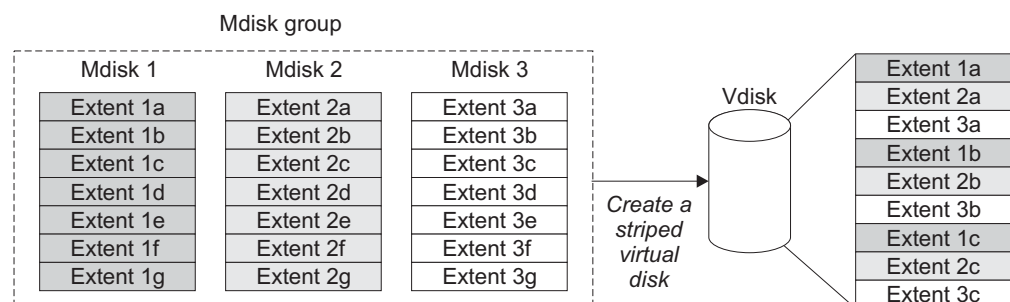

Figure 14. Managed disk groups and VDisks

### Sequential

When selected, extents are allocated sequentially on one managed disk to create the virtual disk if enough consecutive free extents are available on the chosen managed disk.

### Image

Image-mode VDisks are special VDisks that have a direct relationship with one managed disk. If you have a managed disk that contains data that you want to merge into the cluster, you can create an image-mode virtual disk. When you create an image-mode virtual disk, a direct mapping is made between extents that are on the managed disk and extents that are on the

virtual disk. The managed disk is not virtualized. In other words, the logical block address (LBA) x on the managed disk is the same as LBA x on the virtual disk.

When you create an image-mode VDisk, you must assign it to a managed disk group. An image-mode VDisk must be at least one extent in size. In other words, the minimum size of an image-mode VDisk is the extent size of the MDisk group to which it is assigned.

The extents are managed in the same way as other VDIs. When the extents have been created, you can move the data onto other MDisks that are in the group without losing access to the data. After you move one or more extents, the virtual disk becomes a real virtualized disk, and the mode of the managed disk changes from image to managed.

**Attention:** If you add an MDisk to an MDisk group as a managed disk, any data on the MDisk will be lost. Ensure that you create image-mode VDIs from the MDisks that contain data before you start adding any MDisks to groups.

MDisks that contain existing data have an initial mode of unmanaged, and the cluster cannot determine whether it contains partitions or data.

A virtual disk can have one of three states. Table 9 describes the different states of a virtual disk:

Table 9. Virtual disk status

Status	Description
<b>Online</b>	The virtual disk is online and available if both nodes in the I/O group can access the virtual disk. A single node will only be able to access a VDisk if it can access all the MDisks in the MDisk group associated with the VDisk.
<b>Offline</b>	The VDisk is offline and unavailable if both nodes in the I/O group are missing or none of the nodes in the I/O group that are present can access the VDisk.
<b>Degraded</b>	The status of the virtual disk is degraded if one node in the I/O group is online and the other node is either missing or cannot access the virtual disk.

You can also use more sophisticated extent allocation policies to create VDIs. When you create a striped virtual disk, you can specify the same managed disk more than once in the list of MDisks that are used as the stripe set. This is useful if you have a managed disk group in which not all the MDisks are of the same capacity. For example, if you have a managed disk group that has two 18 GB MDisks and two 36 GB MDisks, you can create a striped virtual disk by specifying each of the 36 GB MDisks twice in the stripe set so that two thirds of the storage is allocated from the 36 GB disks.

If you delete a virtual disk, you destroy access to the data that is on the virtual disk. The extents that were used in the virtual disk are returned to the pool of free extents that is in the managed disk group. The deletion might fail if the virtual disk is still mapped to hosts. The deletion might also fail if the virtual disk is still part of a FlashCopy or a Remote Copy mapping. If the deletion fails, you can specify the

force-delete flag to delete both the virtual disk and the associated mappings to hosts. Forcing the deletion will also delete the copy services relationship and mappings.

#### **Related concepts**

“Managed disk groups” on page 24

An *MDisk group* is a collection of MDisks that jointly contain all the data for a specified set of virtual disks (VDisks).

“Managed disk groups and virtual disks (VDisks)” on page 24

Managed disks are collected into groups known as managed disk groups. Virtual disks are logical disks that are presented to the SAN by SAN Volume Controller nodes. The maximum number of supported VDIsks per I/O group is 1024. The maximum number of supported VDIsks per cluster is 4096. Virtual disks, like nodes, are associated with an I/O group.

## **Hosts and virtual (VDisk) mappings**

Application servers can only access VDIsks that have been made accessible to them.

The SAN Volume Controller detects the fibre channel ports that are connected to the SAN. These correspond to the host bus adapter (HBA) worldwide port names (WWPNs) that are present in the application servers. The SAN Volume Controller enables you to create logical hosts that group together WWPNs belonging to a single application server or multiple application servers. VDIsks can then be mapped to a host. The act of mapping a virtual disk to a host makes the virtual disk accessible to the WWPNs in that host, and hence the application server itself.

#### **Related concepts**

“Host objects”

A host system is an open-systems computer that is connected to the switch through a fibre-channel interface.

“Virtual disk-to-host mapping” on page 30

Virtual disk-to-host mapping is the process of controlling which hosts have access to specific virtual disks (VDIsks) within the SAN Volume Controller.

### **Host objects**

A host system is an open-systems computer that is connected to the switch through a fibre-channel interface.

Creating a host in a cluster results in the creation of a logical host object. A logical host object has one or more worldwide port names (WWPNs) assigned to it. Generally, a logical host object is associated with a physical host system. However, a single logical host object can have WWPNs from multiple physical host systems that are assigned to it.

A host object is a logical object that groups one or more worldwide port names (WWPNs) of the host bus adapters (HBAs) that the cluster has detected on the SAN. A typical configuration has one host object for each host that is attached to the SAN. If, however, a cluster of hosts is going to access the same storage, you can add HBA ports from several hosts into the one host object to make a simpler configuration.

The cluster does not automatically present VDIsks on the fibre. You must map each virtual disk to a particular set of ports to enable the virtual disk to be accessed through those ports. The mapping is made between a host object and a virtual disk.

When you create a new host object, the configuration interfaces provide a list of unconfigured WWPNs. These WWPNs represent the fibre channel ports that the cluster has detected.

The cluster can detect only ports that are logged into the fabric. Some HBA device drivers do not let the ports remain logged in if no disks are visible on the fabric. This condition causes a problem when you want to create a host because, at this time, no VDIs are mapped to the host. The configuration interface provides a method by which you can manually enter port names under this condition.

**Attention:** You must not include a node port in a host object.

A port can be added to only one host object. When a port has been added to a host object, that port becomes a configured WWPN, and is not included in the list of ports that are available to be added to other hosts.

### **Node login counts**

The number of nodes that can see each port is reported on a per node basis and is known as the node login count. If the count is less than the number of nodes in the cluster, then there is a fabric problem, and not all nodes can see the port.

#### **Related concepts**

“Hosts and virtual (VDisk) mappings” on page 29

Application servers can only access VDIs that have been made accessible to them.

“Virtual disk-to-host mapping”

Virtual disk-to-host mapping is the process of controlling which hosts have access to specific virtual disks (VDIs) within the SAN Volume Controller.

### **Virtual disk-to-host mapping**

Virtual disk-to-host mapping is the process of controlling which hosts have access to specific virtual disks (VDIs) within the SAN Volume Controller.

Virtual disk-to-host mapping is similar in concept to logical unit number (LUN) mapping or masking. LUN mapping is the process of controlling which hosts have access to specific logical units (LUs) within the disk controllers. LUN mapping is typically done at the disk controller level. Virtual disk-to-host mapping is done at the SAN Volume Controller level.

Application servers can only access VDIs that have been made accessible to them. The SAN Volume Controller detects the fibre-channel ports that are connected to the SAN. These correspond to the host bus adapter (HBA) worldwide port names (WWPNs) that are present in the application servers. The SAN Volume Controller enables you to create logical hosts that group together WWPNs belonging to a single application server. VDIs can then be mapped to a host. The act of mapping a virtual disk to a host makes the virtual disk accessible to the WWPNs in that host, and hence the application server itself.

### **VDIs and host mappings**

The SAN concept known as LUN masking usually requires device driver software in each host. The device driver software masks the LUNs as instructed by the user. After the masking has been done, only some disks are visible to the operating system. The SAN Volume Controller performs a similar function, but, by default, it

presents to the host only those VDisks that are mapped to that host. You must therefore map the VDisks to the hosts that are to access those VDisks.

Each host mapping associates a virtual disk with a host object and allows all HBA ports in the host object to access the virtual disk. You can map a virtual disk to multiple host objects. When a mapping is created, multiple paths might exist across the SAN fabric from the hosts to the SAN Volume Controllers that are presenting the virtual disk. Most operating systems present each path to a virtual disk as a separate storage device. The SAN Volume Controller, therefore, needs the IBM Subsystem Device Driver (SDD) software to be running on the host. This software handles the many paths that are available to the virtual disk and presents a single storage device to the operating system.

When you map a virtual disk to a host, you can optionally specify a SCSI ID for the virtual disk. This ID controls the sequence in which the VDisks are presented to the host. Take care when you specify a SCSI ID, because some device drivers stop looking for disks if they find an empty slot. For example, if you present three VDisks to the host, and those VDisks have SCSI IDs of 0, 1, and 3, the virtual disk that has an ID of 3 might not be found because no disk is mapped with an ID of 2. The cluster automatically assigns the next available SCSI ID if none is entered.

Figure 15 and Figure 16 on page 32 show two VDisks, and the mappings that exist between the host objects and these VDisks.

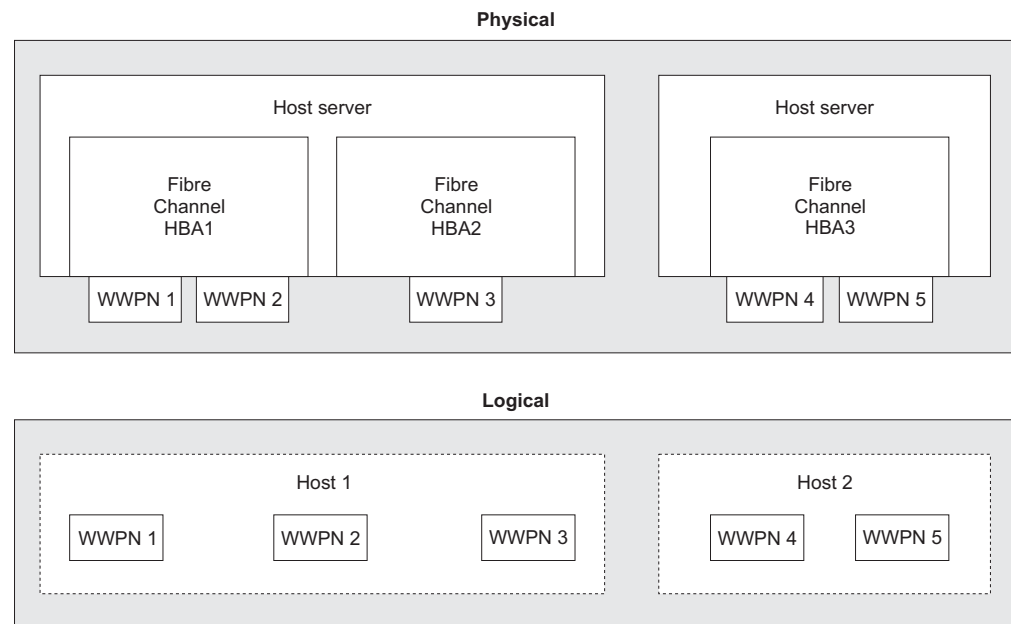

Figure 15. Hosts, WWPNs, and VDisks

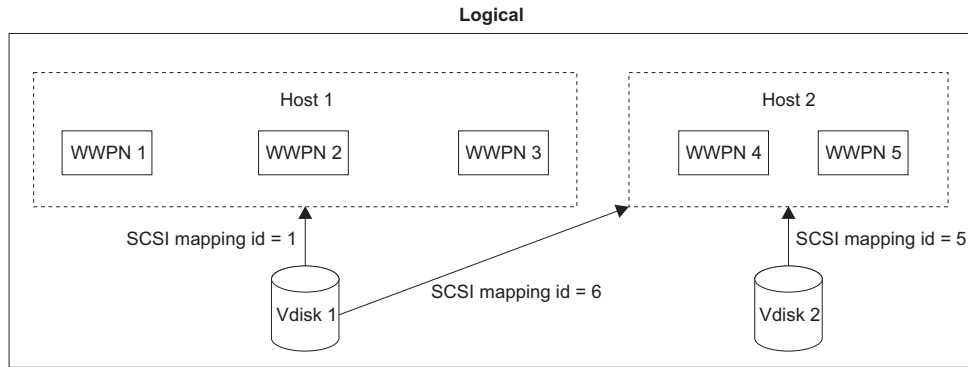

Figure 16. Hosts, WWPNs, VDisks and SCSI mappings

### Related concepts

“Host objects” on page 29

A host system is an open-systems computer that is connected to the switch through a fibre-channel interface.

“Hosts and virtual (VDisk) mappings” on page 29

Application servers can only access VDisks that have been made accessible to them.

---

## Copy Services

There are two types of Copy Service supported by the SAN Volume Controller.

One is called FlashCopy and the other is synchronous Remote Copy (which is analogous to Peer-to-Peer Remote Copy or PPRC).

### Related concepts

“FlashCopy”

FlashCopy is a copy service available with the SAN Volume Controller.

“Remote Copy” on page 44

Remote Copy enables you to set up a relationship between two virtual disks, so that updates that are made by an application to one virtual disk are mirrored on the other virtual disk.

## FlashCopy

FlashCopy is a copy service available with the SAN Volume Controller.

It copies the contents of a source virtual disk (VDisk) to a target VDisk. Any data that existed on the target disk is lost and is replaced by the copied data. After the copy operation has been completed, the target virtual disks contain the contents of the source virtual disks as they existed at a single point in time unless target writes have been performed. Although the copy operation takes some time to complete, the resulting data on the target is presented in such a way that the copy appears to have occurred immediately. FlashCopy is sometimes described as an instance of a time-zero copy (T 0 ) or point-in-time copy technology. Although the FlashCopy operation takes some time, this time is several orders of magnitude less than the time which would be required to copy the data using conventional techniques.

It is difficult to make a consistent copy of a data set that is being constantly updated. Point-in-time copy techniques are used to help solve the problem. If a copy of a data set is taken using a technology that does not provide point in time

techniques and the data set changes during the copy operation, then the resulting copy may contain data which is not consistent. For example, if a reference to an object is copied earlier than the object itself and the object is moved before it is itself copied then the copy will contain the referenced object at its new location but the reference will point to the old location.

Source VDisks and target VDisks must meet the following requirements:

- They must be the same size.
- The same cluster must manage them.

#### **Related concepts**

“FlashCopy mappings” on page 35

A FlashCopy mapping defines the relationship between a source VDisk and a target VDisk.

“FlashCopy consistency groups” on page 39

A consistency group is a container for mappings. You can add many mappings to a consistency group.

#### **Related tasks**

“Host considerations for FlashCopy integrity” on page 34

The SAN Volume Controller FlashCopy functionality transfers a point-in-time copy of one virtual disk onto a designated target virtual disk of the same size. Both virtual disks must already be created.

#### **Related reference**

“FlashCopy applications”

Uses of FlashCopy in the business environment include taking consistent backups of changing data, application testing, and creating copies for auditing purposes and for data mining.

“FlashCopy indirection layer” on page 41

FlashCopy provides the semantics of a point in time copy by using an indirection layer which intercepts I/Os targeted at both the source and target virtual disks.

“Background copy” on page 43

A FlashCopy mapping has a property background copy rate.

## **FlashCopy applications**

Uses of FlashCopy in the business environment include taking consistent backups of changing data, application testing, and creating copies for auditing purposes and for data mining.

An important use of FlashCopy is to take consistent backups of changing data. In this application, a FlashCopy is created to capture the data at a particular time. The resulting image of the data can be backed up, for example, to a tape device. When the copied data is on tape, the data on the FlashCopy target disks becomes redundant and can now be discarded. Usually in this backup condition, the target data can be handled as read only.

Another use of FlashCopy data is in the application testing. It is often very important to test a new version of an application with real business data before the existing production version of the application is updated or replaced. This testing reduces the risk that the updated application fails because it is not compatible with the actual business data that is in use at the time of the update. Such an application test might require write access to the target data.

Other uses of FlashCopy in the business environment include creating copies for auditing purposes and for data mining.

In the scientific and technical arena one way in which FlashCopy is employed is to create restart points for long running batch jobs. This means that if a batch job fails many days into its run it may be possible to restart the job from a saved copy of its data rather than re-running the entire multi-day job.

#### **Related concepts**

“FlashCopy” on page 32

FlashCopy is a copy service available with the SAN Volume Controller.

#### **Host considerations for FlashCopy integrity**

The SAN Volume Controller FlashCopy functionality transfers a point-in-time copy of one virtual disk onto a designated target virtual disk of the same size. Both virtual disks must already be created.

All the data in the source virtual disk is copied to the destination virtual disk. This includes operating system control information as well as application data and meta-data. Because all the data is copied, some operating systems will not allow a source disk and a target disk to reside on the same host. In order to ensure the integrity of the copy made, it is necessary to completely flush the host cache of any outstanding reads or writes before proceeding with the FlashCopy. Host cache flushing is ensured by unmounting the source virtual disks from the source host before starting the FlashCopy.

Because the target disks will be overwritten with a complete image of the source disks, it is important that any data held in the host operating system (or application) caches for the target disks is discarded before the FlashCopy mappings are started. The easiest way to ensure that no data is held in these caches is to unmount the target disks prior to starting FlashCopy.

Some operating systems and applications provide facilities to stop I/O operations and to ensure that all data is flushed from caches on the host. If these facilities are available then they can be used to prepare and start a FlashCopy in a less disruptive manner. Refer to your host and application documentation for details.

Some operating systems are unable to use a copy of a virtual disk without an additional step, which is called synthesis. Synthesis performs some transformation on the operating system meta-data on the target virtual disk to allow the operating system to use the disk. Refer to your host documentation on how to detect and mount the copied virtual disks.

Perform the following steps to flush data from your host volumes and perform the FlashCopy:

1. If you are using UNIX or Linux operating systems, perform the following steps:
  - a. Quiesce all applications to the source volumes you wish to FlashCopy.
  - b. Use the **umount** command to unmount the designated drives.
  - c. Prepare and start the FlashCopy for those unmounted drives.
  - d. Mount back your volumes with the mount command and resume your applications.
2. If you are using Windows operating system using drive letter changes, perform the following steps:
  - a. Quiesce all applications to the source volumes you wish to FlashCopy.
  - b. Go into your disk management window and remove the drive letter on each drive to be copied (this unmounts the drive).
  - c. Prepare and start the FlashCopy for those unmounted drives.



- d. Mount back your volumes by restoring the drive letters, and resume your applications.

If you are using the **chkdsk** command, perform the following steps:

- a. Quiesce all applications to the source volumes you wish to FlashCopy.
- b. Issue the **chkdsk /x** command on each drive to be copied (the /x option will unmount, scan, and remount the volume).
- c. Ensure that all applications to the source volumes are still quiesced.
- d. Prepare and start the FlashCopy for those unmounted drives.

**Note:** If you can ensure that no reads and writes will be issued to the source volumes after unmounting, you can immediately remount and then perform the FlashCopy.

#### **Related concepts**

“FlashCopy” on page 32

FlashCopy is a copy service available with the SAN Volume Controller.

### **FlashCopy mappings**

A FlashCopy mapping defines the relationship between a source VDisk and a target VDisk.

Because FlashCopy copies one VDisk to another VDisk, the SAN Volume Controller Console needs to be aware of that relationship. A particular virtual disk can take part in only one mapping; that is, a virtual disk can be the source or target of only one mapping. You cannot, for example, make the target of one mapping the source of another mapping.

FlashCopy makes an instant copy of a virtual disk at the time it is started. To create a FlashCopy of a virtual disk, you must first create a mapping between the source virtual disk (the disk that is copied) and the target virtual disk (the disk that receives the copy). The source and target must be of equal size.

To copy a VDisk, it must be part of a FlashCopy mapping or of a consistency group.

A FlashCopy mapping can be created between any two virtual disks in a cluster. It is not necessary for the virtual disks to be in the same I/O group or managed disk group. When a FlashCopy operation is started, a checkpoint is made of the source virtual disk. No data is actually copied at the time a start occurs. Instead, the checkpoint creates a bitmap that indicates that no part of the source virtual disk has yet been copied. Each bit in the bitmap represents one region of the source virtual disk. Such a region is called a grain.

After a FlashCopy operation starts, read operations to the source virtual disk continue to occur. If new data is written to the source (or target) virtual disk, then the existing data on the source is copied to the target virtual disk before the new data is written to the source (or target) virtual disk. The bitmap is updated to mark that the grain of the source virtual disk has been copied so that later write operations to the same grain do not recopy the data.

Similarly, during a read operation to the target virtual disk the bitmap is used to determine whether or not the grain has been copied. If the grain has been copied, the data is read from the target virtual disk. If the grain has not been copied, the data is read from the source virtual disk.

When you create a mapping, you specify the background copy rate. This rate determines the priority that is given to the background copy process. If you want to end with a copy of the whole source at the target (so that the mapping can be deleted, but the copy can still be accessed at the target), you must copy to the target virtual disk all the data that is on the source virtual disk.

When a mapping is started and the background copy rate is greater than zero (or a value other than NOCOPY is selected in the SAN Volume Controller Console's Creating FlashCopy Mappings panel), the unchanged data is copied to the target, and the bitmap is updated to show that the copy has occurred. After a time, the length of which depends on the priority given and the size of the virtual disk, the whole virtual disk is copied to the target. The mapping returns to the idle/copied state. You can restart the mapping at any time to create a new copy at the target; the process copy starts again.

If the background copy rate is zero (or NOCOPY), only the data that changes on the source is copied to the target. The target never contains a copy of the whole source unless every extent is overwritten at the source. You can use this copy rate when you need only a temporary copy of the source.

You can stop the mapping at any time after it has been started. This action makes the target inconsistent and therefore the target virtual disk is taken offline. You must restart the mapping to correct the target.

### **FlashCopy mapping states**

At any point in time, a FlashCopy mapping is in one of the following states:

#### **Idle or copied**

The source and target VDIs act as independent VDIs even if a FlashCopy mapping exists between the two. Read and write caching is enabled for both the source and the target.

#### **Copying**

The copy is in progress.

#### **Prepared**

The mapping is ready to start. While in this state, the target VDisk is offline.

#### **Preparing**

Any changed write data for the source VDisk is flushed from the cache. Any read or write data for the target VDisk is discarded from the cache.

#### **Stopped**

The mapping is stopped because either you issued a command or an input/output (I/O) error occurred. Preparing and starting the mapping again can restart the copy.

#### **Suspended**

The mapping started, but it did not complete. The source VDisk might be unavailable, or the copy bitmap might be offline. If the mapping does not return to the copying state, stop the mapping to reset the mapping.

Before you start the mapping, you must prepare it. By preparing the mapping, you ensure that the data in the cache is destaged to disk and that a consistent copy of the source exists on disk. At this time the cache goes into write-through mode. Data that is written to the source is not cached in the SAN Volume Controllers; it passes straight through to the managed disks. The prepare operation for the mapping might take you a few minutes; the actual length of time depends on the size of the source

virtual disk. You must coordinate the prepare operation with the operating system. Depending on the type of data that is on the source virtual disk, the operating system or application software might also cache data write operations. You must flush, or synchronize, the file system and application program before you prepare for, and finally start, the mapping.

For customers who do not need the complexity of consistency groups, the SAN Volume Controller allows a FlashCopy mapping to be treated as an independent entity. In this case the FlashCopy mapping is known as a stand alone mapping. For FlashCopy mappings which have been configured in this way, the **Prepare** and **Start** commands are directed at the FlashCopy mapping name rather than the consistency group ID.

### Veritas Volume Manager

For FlashCopy target VDisks, the SAN Volume Controller sets a bit in the inquiry data for those mapping states where the target VDisk could be an exact image of the source VDisk. Setting this bit enables the Veritas Volume Manager to distinguish between the source and target VDisks and thus provide independent access to both.

#### Related reference

“FlashCopy mapping events”

FlashCopy mapping events details the events that modify the state of a FlashCopy mapping.

#### **FlashCopy mapping events:**

FlashCopy mapping events details the events that modify the state of a FlashCopy mapping.

Table 10. FlashCopy mapping events

<b>Create</b>	A new FlashCopy mapping is created between the specified source virtual disk and the specified target virtual disk. The various supported parameters are also described there. The operation fails if either the source or target virtual disks are already a member of a FlashCopy mapping. The operation fails if the SAN Volume Controller has insufficient bitmap memory. The operation also fails if the source and target virtual disks are different sizes.
<b>Prepare</b>	The prepare command is directed to either a consistency group for FlashCopy mappings which are members of a normal consistency group or to the mapping name for FlashCopy mappings which are members of the special consistency group 0. The prepare command places the FlashCopy mapping in the preparing state.  It is important to note that the act of preparing for start may corrupt any data which previously resided on the target virtual disk since cached writes are discarded. Even if the FlashCopy mapping is never started, the data from the target may have been logically changed by the act of preparing for start.
<b>Flush done</b>	The FlashCopy relationship moves from the preparing state to the prepared state automatically once all cached data for the source has been flushed and all cached data for the target has been invalidated.

Table 10. FlashCopy mapping events (continued)

<b>Start</b>	<p>When all the FlashCopy mappings in a consistency group are in the prepared state, the FlashCopy relationships can be started. Some other FlashCopy products refer to this event as starting the FlashCopy.</p> <p>The start of all of the FlashCopy mappings in the consistency group must be synchronized correctly with respect to I/Os directed at the virtual disks to preserve the cross volume consistency group. This is achieved as follows:</p> <p>During the <b>start</b> command:</p> <ul style="list-style-type: none"> <li>• New reads and writes to all source virtual disks in the consistency group are paused in the cache layer until all ongoing reads and writes below the cache layer have been completed.</li> <li>• Once all FlashCopy mappings in the consistency group have been paused, internal cluster state is set to allow FlashCopy operations.</li> <li>• Once all FlashCopy mappings in the consistency group have had their cluster state set, read and write operations are unpaused on the source virtual disks.</li> <li>• The target virtual disks are brought online.</li> </ul> <p>As part of the <b>start</b> command, read and write caching is enabled for both the source and target virtual disks.</p>
<b>Modify</b>	<p>A FlashCopy mapping has two properties which can be modified. These are the background copy rate and the consistency group. The background copy rate can be modified in any state but attempting to modify the consistency group in any state other than idling, copied, or stopped will fail.</p>
<b>Stop</b>	<p>There are two mechanisms by which a FlashCopy mapping can be stopped:</p> <ol style="list-style-type: none"> <li>1. Either you have issued a command; or</li> <li>2. An input/output (I/O) error has occurred.</li> </ol>
<b>Delete</b>	<p>This command requests that the specified FlashCopy mapping be deleted. If the FlashCopy mapping is in the stopped state, the force flag must be used.</p> <p>Deleting a FlashCopy mapping in the stopped state may allow unflushed write data from the cache to be destaged to what was the target virtual disk. This does not affect the data integrity of the system because following a forced delete, nothing can be certain about the contents of the target virtual disk. The data contained in the target virtual disk could be anything.</p> <p>The destaging of old data to what was the target virtual disk does not affect the future use of the virtual disk because any new data will be written over this old data, in the cache or on disk.</p>
<b>Flush failed</b>	<p>If the flush of data from the cache cannot be completed then FlashCopy mapping will enter the stopped state.</p>
<b>Copy complete</b>	<p>Once every grain of the source and target has been copied, the source and target are independent and the state machine enters the copied state. The FlashCopy mapping is not automatically deleted at this time and can be reactivated by preparing and starting again.</p>
<b>Bitmap Online/Offline</b>	<p>The node has failed.</p>

**Related concepts**

“FlashCopy mappings” on page 35

A FlashCopy mapping defines the relationship between a source VDisk and a target VDisk.

## **FlashCopy consistency groups**

A consistency group is a container for mappings. You can add many mappings to a consistency group.

The consistency group is specified when the mapping is created. You can also change the consistency group later. When you use a consistency group, you prepare and trigger that group instead of the various mappings. This ensures that a consistent copy is made of all the source VDIs. Mappings that you want to control at an individual level instead of at a consistency group level, should not be put into a consistency group. These mappings are known as stand-alone mappings.

To copy a VDisk, it must be part of a FlashCopy mapping or of a consistency group.

When you copy data from one virtual disk (VDisk) to another, that data might not include all that you need to enable you to use the copy. Many applications have data that spans multiple VDIs and that include the requirement that data integrity is preserved across VDIs. For example, the logs for a particular database usually reside on a different VDisk than the VDisk that contains the data.

Consistency groups address the problem when applications have related data that spans multiple VDIs. In this situation, FlashCopy must be performed in a way that preserves data integrity across the multiple VDIs. One requirement for preserving the integrity of data being written is to ensure that dependent writes are run in the intended sequence of the application.

## **FlashCopy consistency group states**

At any point in time, a FlashCopy consistency group is in one of the following states:

### **Idle or copied**

The source and target VDIs act independently even if a FlashCopy consistency group exists. Read and write caching is enabled for the source VDIs and target VDIs.

### **Copying**

The copy is in progress.

### **Prepared**

The consistency group is ready to start. While in this state, the target VDIs are offline.

### **Preparing**

Any changed write data for the source VDIs is flushed from the cache.  
Any read or write data for the target VDIs is discarded from the cache.

### **Stopped**

The consistency group is stopped because either you issued a command or an input/output (I/O) error occurred. Preparing and starting the consistency group again can restart the copy.

### **Suspended**

The consistency group was started, but it did not complete. The source VDIs might be unavailable, or the copy bitmap might be offline. If the

consistency group does not return to the copying state, stop the consistency group to reset the consistency group.

#### **Related reference**

“Dependent writes”

One requirement for preserving the integrity of data being written is to ensure that dependent writes are run in the intended sequence of the application.

“Operations on consistency groups” on page 41

You can create, change, and delete consistency groups.

“FlashCopy limits” on page 41

The SAN Volume Controller supports 128 Flash Copy consistency groups per cluster.

#### ***Dependent writes:***

One requirement for preserving the integrity of data being written is to ensure that dependent writes are run in the intended sequence of the application.

Think about the following typical sequence of write operations for a data base update transaction.

1. Run a write operation to update the data base log so that it indicates that a data base update is about to take place.
2. Run a second write operation to update the data base.
3. Run a third write operation to update the data base log so that it indicates that the data base update has completed successfully.

The database ensures correct ordering of these writes by waiting for each step to complete before starting the next. If, however, the database log (updates 1 and 3) and the database itself (update 2) are on different virtual disks and a FlashCopy mapping is started during this update, then the possibility that the database itself is copied slightly before the database log resulting in the target virtual disks seeing writes (1) and (3) but not (2) must be excluded. In this case, if the database were restarted from a backup made from the FlashCopy target disks, the data base log would indicate that the transaction had completed successfully when, in fact, that is not the case. The transaction would be lost and the integrity of the data base would be in question.

It may thus be the case that in order to create a consistent image of user data it is necessary to perform a FlashCopy operation on multiple virtual disks as an atomic operation. In order to meet this need, the SAN Volume Controller supports the concept of a consistency group. A consistency group contains a number of FlashCopy mappings. A consistency group can contain an arbitrary number of FlashCopy mappings up to the maximum number of FlashCopy mappings supported by a SAN Volume Controller cluster. The SAN Volume Controller allows the **start** command which causes the point in time copy to occur, to be directed at a consistency group. In this case all of the FlashCopy mappings in the consistency group are started at the same time, resulting in a point in time copy which is consistent across all of the FlashCopy mappings which are contained in the consistency group. The SAN Volume Controller supports 128 consistency groups per cluster.

#### **Related concepts**

“FlashCopy consistency groups” on page 39

A consistency group is a container for mappings. You can add many mappings to a consistency group.

### ***Operations on consistency groups:***

You can create, change, and delete consistency groups.

You can create, change, and delete consistency groups by using the command line tool that is described in *IBM TotalStorage SAN Volume Controller: Command-Line Interface User's Guide* or you can use the SAN Volume Controller Console.

#### **Related concepts**

“FlashCopy consistency groups” on page 39

A consistency group is a container for mappings. You can add many mappings to a consistency group.

### ***FlashCopy limits:***

The SAN Volume Controller supports 128 Flash Copy consistency groups per cluster.

#### **Related concepts**

“FlashCopy consistency groups” on page 39

A consistency group is a container for mappings. You can add many mappings to a consistency group.

### **FlashCopy indirection layer**

FlashCopy provides the semantics of a point in time copy by using an indirection layer which intercepts I/Os targeted at both the source and target virtual disks.

The act of starting a FlashCopy mapping causes this indirection layer to become active in the I/O path. This occurs as an atomic command across all FlashCopy mappings in the consistency group.

The indirection layer makes a decision about each I/O. This decision is based upon the following:

- the virtual disk and LBA to which the I/O is addressed,
- its direction (read or write)
- the state of an internal data structure, the flash copy bitmap.

The indirection layer either allows the I/O through to the underlying storage, redirects the I/O from the target virtual disk to the source virtual disk, or stalls the I/O while it arranges for data to be copied from the source virtual disk to the target virtual disk.

#### **Related reference**

“Grains and the FlashCopy bitmap” on page 42

When data is copied from the source virtual disk to the target virtual disk, it is copied in units of address space known as grains.

“Source and target reads” on page 42

The source and target must be of equal size. A particular virtual disk can take part in only one mapping; that is, a virtual disk can be the source or target of only one mapping.

“Writes to the source or target” on page 42

Where writes occur to source or target to an area (or grain) which has not yet been copied, these will usually be delayed while a copy operation is performed to copy data from the source to the target, to maintain the illusion that the target contains its own copy.

“FlashCopy limits” on page 43

There are FlashCopy limits as to how many mappings are supported in a single cluster.

### ***Grains and the FlashCopy bitmap:***

When data is copied from the source virtual disk to the target virtual disk, it is copied in units of address space known as grains.

In the SAN Volume Controller, the grain size is 256 KB. The FlashCopy bitmap contains one bit for each grain. The bit records whether the associated grain has yet been split by copying the grain from the source to the target.

#### **Related reference**

“FlashCopy indirection layer” on page 41

FlashCopy provides the semantics of a point in time copy by using an indirection layer which intercepts I/Os targeted at both the source and target virtual disks.

### ***Source and target reads:***

The source and target must be of equal size. A particular virtual disk can take part in only one mapping; that is, a virtual disk can be the source or target of only one mapping.

#### **Source reads**

Reads of the source are always passed through to the underlying source disk.

#### **Target reads**

In order for FlashCopy to process a read from the target disk it must consult its bitmap. If the data being read has already been copied to the target then the read is sent to the target disk. If it has not, then the read is sent to the source disk. Clearly this algorithm requires that, while this read is outstanding, no writes are allowed to execute which would change the data being read from the source. The SAN Volume Controller satisfies this requirement by using a cluster wide locking scheme.

FlashCopy limits the number of concurrent reads to an unsplit target grain to one. If more than one concurrent read to an unsplit target grain is received by the FlashCopy mapping layer, they will be serialized.

#### **Related reference**

“FlashCopy indirection layer” on page 41

FlashCopy provides the semantics of a point in time copy by using an indirection layer which intercepts I/Os targeted at both the source and target virtual disks.

### ***Writes to the source or target:***

Where writes occur to source or target to an area (or grain) which has not yet been copied, these will usually be delayed while a copy operation is performed to copy data from the source to the target, to maintain the illusion that the target contains its own copy.

A specific optimization is performed where an entire grain is written to the target virtual disk. In this case the new grain contents are written to the target virtual disk



and if this succeeds the grain is marked as split in the flash copy bitmap without a copy from the source to the target having been performed. If the write fails, the grain is not marked as split.

**Related reference**

“FlashCopy indirection layer” on page 41

FlashCopy provides the semantics of a point in time copy by using an indirection layer which intercepts I/Os targeted at both the source and target virtual disks.

**FlashCopy limits:**

There are FlashCopy limits as to how many mappings are supported in a single cluster.

Up to 512 FlashCopy mappings are supported in a single cluster. A maximum of 16 TB of VDisk space (both source and target) may be participating in FlashCopy mappings in any one I/O group on a single cluster.

**Related reference**

“FlashCopy indirection layer” on page 41

FlashCopy provides the semantics of a point in time copy by using an indirection layer which intercepts I/Os targeted at both the source and target virtual disks.

**Background copy**

A FlashCopy mapping has a property background copy rate.

This is a value between 1 and 100. The background copy rate can be changed when the FlashCopy mapping is in any state.

If “NOCOPY” is specified, then background copy is disabled. One use of this is for short-lived FlashCopy mappings which are to be used for backup purposes only. Since the source data set is not expected to change much during the lifetime of the FlashCopy mapping, it is more efficient in terms of managed disk I/Os not to perform a background copy.

Table 11 provides the relationship of the background copy rate value to the attempted number of grains to be split per second. (A grain is the unit of data represented by a single bit, which is 256K.)

*Table 11. Background copy*

User-specified value	KB/sec	Grains/sec
1 - 10	128	0.5
11 - 20	256	1
21 - 30	512	2
41 - 50	2048	8
91 - 100	64 MB	256

The grains/sec numbers represent goals that the code tries to achieve. The SAN Volume Controller will be unable to achieve these goals if insufficient bandwidth is available from the SAN Volume Controller nodes to the physical disks making up the managed disks after taking into account the requirements of foreground I/O. If this situation arises, then background copy I/O will contend for resources on an equal basis with I/O arriving from hosts. Both will tend to see an increase in latency and consequential reduction in throughput with respect to the situation had the bandwidth not been limited.

Degradation will be graceful. Both background copy and foreground I/O will continue to make forward progress, and will not stop, hang or cause the node to fail.

The background copy is performed by one of the nodes belonging to the I/O group in which the source virtual disk resides. This responsibility is failed over to the other node in the I/O group in the event of the failure of the node performing the background copy.

The background copy is performed backward; that is, it starts with the grain containing the highest logical block numbers (LBAs) and works backwards towards the grain containing LBA 0. This is done to avoid any unwanted interactions with sequential write streams from the using application.

#### **Related concepts**

“FlashCopy” on page 32

FlashCopy is a copy service available with the SAN Volume Controller.

## **Remote Copy**

Remote Copy enables you to set up a relationship between two virtual disks, so that updates that are made by an application to one virtual disk are mirrored on the other virtual disk.

Although the application only writes to a single virtual disk, the SAN Volume Controller maintains two copies of the data. If the copies are separated by a significant distance, then the remote copy can be used as a backup for disaster recovery. A prerequisite for the SAN Volume Controller Remote Copy operations between two clusters is that the SAN fabric to which they are attached provides adequate bandwidth between the clusters.

One VDisk is designated the primary and the other VDisk is designated the secondary. Host applications write data to the primary VDisk, and updates to the primary VDisk are copied to the secondary VDisk. Normally, host applications do not perform input or output operations to the secondary VDisk. When a host writes to the primary VDisk, it will not receive confirmation of I/O completion until the write operation has completed for the copy on the secondary disk as well as on the primary.

Remote Copy supports the following features:

- Intracluster copying of a VDisk, in which both VDIsks belong to the same cluster and I/O group within the cluster.
- Intercluster copying of a VDisk, in which one VDisk belongs to a cluster and the other VDisk belongs to a different cluster

**Note:** A cluster can only participate in active Remote Copy relationships with itself and one other cluster.

- Intercluster and intracluster Remote Copy can be used concurrently within a cluster.
- The intercluster link is bidirectional. Meaning, it can support copying of data from clusterA to clusterB for one pair of VDIsks while copying data from clusterB to clusterA for a different pair of VDIsks.
- The copy direction can be reversed for a consistent relationship by issuing a simple **switch** command. See *IBM TotalStorage SAN Volume Controller: Command-Line Interface User's Guide*.

- Remote Copy consistency groups are supported for ease of managing a group of relationships that need to be kept in sync for the same application. This also simplifies administration, as a single command issued to the consistency group will be applied to all the relationships in that group.

#### **Related concepts**

“Synchronous Remote Copy”

In the synchronous mode, Remote Copy provides a *consistent copy*, which means that the primary VDisk is always the exact match of the secondary VDisk.

“Remote Copy partnerships”

With Remote Copy, you can copy a VDisk in one cluster to a VDisk in another cluster.

“Remote Copy relationships” on page 46

A Remote Copy relationship defines the relationship between two virtual disks: a master VDisk and an auxiliary VDisk.

“Remote Copy consistency groups” on page 48

Remote Copy provides the facility to group a number of relationships into a Remote Copy consistency group so that they can be manipulated in unison.

### **Synchronous Remote Copy**

In the synchronous mode, Remote Copy provides a *consistent copy*, which means that the primary VDisk is always the exact match of the secondary VDisk.

The host application writes data to the primary VDisk but does not receive the final status on the write operation until the data is written to the secondary VDisk. For disaster recovery, this mode is the only practical mode of operation because a consistent copy of the data is maintained. However, synchronous mode is slower than asynchronous mode because of the latency time and bandwidth limitations imposed by the communication link to the secondary site.

#### **Related concepts**

“Remote Copy” on page 44

Remote Copy enables you to set up a relationship between two virtual disks, so that updates that are made by an application to one virtual disk are mirrored on the other virtual disk.

### **Remote Copy partnerships**

With Remote Copy, you can copy a VDisk in one cluster to a VDisk in another cluster.

The SAN Volume Controller needs to know not only about the relationship between the two VDIs but also about the relationship between the two clusters. A Remote Copy partnership defines the relationship between the two clusters.

To establish a cluster partnership between two clusters it is necessary to issue the **svctask mkpartnership** command from both clusters. For example, to establish a partnership between clusterA and clusterB, you would first issue the **svctask mkpartnership** command from clusterA, specifying clusterB as the remote cluster. At this point the partnership is partially configured, and sometimes described as one-way. Next, you would issue the **svctask mkpartnership** command from clusterB, specifying clusterA as the remote cluster. When this completes, the partnership is fully configured for two-way communication between the clusters. See *IBM TotalStorage SAN Volume Controller: Command-Line Interface User's Guide*.

## Background copy management

You can specify the rate at which the initial background copy from the local cluster to the remote cluster is performed. The bandwidth parameter controls this rate.

### Related concepts

“Remote Copy” on page 44

Remote Copy enables you to set up a relationship between two virtual disks, so that updates that are made by an application to one virtual disk are mirrored on the other virtual disk.

## Background copy bandwidth impact on foreground I/O latency

The background copy bandwidth determines the rate at which the PPRC background copy will be attempted.

The background copy bandwidth can affect foreground I/O latency in one of three ways:

- The following result can occur if the background copy bandwidth is set too high for the PPRC intercluster link capacity:
  - The background copy I/Os can back up on the PPRC intercluster link
  - There is a delay in the synchronous secondary writes of foreground I/Os
  - The foreground I/O latency will increase as perceived by applications.
- If the background copy bandwidth is set too high for the storage at the *primary* site, background copy read I/Os overload the primary storage and delay foreground I/Os.
- If the background copy bandwidth is set too high for the storage at the *secondary* site, background copy writes at the secondary overload the secondary storage and again delay the synchronous secondary writes of foreground I/Os.

In order to set the background copy bandwidth optimally, make sure that you consider all three resources (the primary storage, the intercluster link bandwidth and the secondary storage). Provision the most restrictive of these three resources between the background copy bandwidth and the peak foreground I/O workload.

This provisioning may be done by calculation as above or alternatively by determining experimentally how much background copy can be allowed before the foreground I/O latency becomes unacceptable and then backing off to allow for peaks in workload and some safety margin.

### Related concepts

“FlashCopy” on page 32

FlashCopy is a copy service available with the SAN Volume Controller.

## Remote Copy relationships

A Remote Copy relationship defines the relationship between two virtual disks: a master VDisk and an auxiliary VDisk.

In most cases, the master VDisk contains the production copy of the data and is the VDisk that the application normally accesses. The auxiliary VDisk typically contains a backup copy of the data and is used in disaster recovery scenarios.

The master and auxiliary VDisks are defined when the relationship is created, and these attributes never change. However, either VDisk may operate in the primary or secondary role according to the circumstances. The primary VDisk is the one currently receiving updates from the application, analogous to source VDisk. The secondary VDisk receives a copy of any updates to the primary VDisk, because

these updates are all transmitted across the Remote Copy link. Therefore, the secondary VDisk is analogous to a continuously updated target VDisk.

**Primary**

Contains a valid copy of the application data, and it is accessible for application write operations.

**Secondary**

Might contain a valid copy of the application data, but it is not available for application write operations.

When a relationship is created, the master VDisk is assigned the role of primary VDisk and the auxiliary VDisk is assigned the role of secondary VDisk. Therefore, the initial copying direction is from master to auxiliary. When the relationship is in a consistent state, the copy direction can be reversed by issuing the **svctask switchrcrelationship** command, and specifying the auxiliary disk as the primary.

The two VDIs in a relationship must be the same size. When the two VDIs are in the same cluster, they must be in the same input/output (I/O) group.

A relationship can be added to a Remote Copy consistency group, for ease of application management (see consistency groups below).

**Note:** Membership of a consistency group is an attribute of the relationship, not the consistency group. Therefore, the **svctask chrcrelationship** command is used to add or remove a relationship to or from a consistency group. See *IBM TotalStorage SAN Volume Controller: Command-Line Interface User's Guide*.

**Remote Copy states**

When a Remote Copy relationship is created with two virtual disks in different clusters, the distinction between the connected and disconnected states is important. These states apply to both the cluster, relationships, and consistency groups.

**Inconsistent (Stopped)**

The primary VDisk is accessible for read and write input/output (I/O) operations but the secondary VDisk is not accessible for either. A copy process needs to be started to make the Secondary VDisk consistent.

**Inconsistent (Copying)**

The primary VDisk is accessible for read and write I/O operations but the secondary VDisk is not accessible for either. This state is entered after a **Start** command is issued to an consistency group in the InconsistentStopped state. This state is also entered when a **Start** command is issued, with the force option, to a consistency group in the Idling or ConsistentStopped state.

**Consistent (Stopped)**

The secondary VDisk contains a consistent image, but it might be out-of-date with respect to the primary VDisk. This state can happen when a relationship was in the ConsistentSynchronized state and experiences an error which forces a freeze of the consistency group. This state can also happen when a relationship is created with the CreateConsistentFlag set to TRUE.

**Consistent (Synchronized)**

The primary VDisk is accessible for read and write I/O operations. The secondary VDisk is accessible for read-only I/O operations.

**Idling** A master VDisk and a auxiliary VDisk operates in the primary role. Consequently the VDisk is accessible for write I/O operations.

**Idling (Disconnected)**

The VDisk is in this half of the consistency group are all operating in the primary role and can accept read or write I/O operations.

**Inconsistent (Disconnected)**

The VDisk is in this half of the consistency group are all operating in the secondary role and will not accept read or write I/O operations.

**Consistent (Disconnected)**

The VDisk is in this half of the consistency group are all operating in the secondary role and will accept read I/O operations but not write I/O operations

**Related concepts**

“Remote Copy” on page 44

Remote Copy enables you to set up a relationship between two virtual disks, so that updates that are made by an application to one virtual disk are mirrored on the other virtual disk.

**Remote Copy consistency groups**

Remote Copy provides the facility to group a number of relationships into a Remote Copy consistency group so that they can be manipulated in unison.

Certain uses of Remote Copy require the manipulation of more than one relationship. A command issued to the consistency group will be applied to all of the relationships in the group simultaneously.

For some uses it might be that the relationships share some loose association and that the grouping simply provides a convenience for the administrator. But a more significant use arises when the relationships contain VDIsks that have a tighter association. One example is when the data for an application is spread across more than one VDisk. A more complex example is when multiple applications run on different host systems. Each application has data on different VDIsks, and these applications exchange data with each other. Both these examples are cases in which specific rules exist as to how the relationships must be manipulated, in unison. This ensures that the set of secondary VDIsks contains usable data. The key property is that these relationships be consistent. Hence, the groups are called consistency groups.

A relationship can be part of a single consistency group or not be part of a consistency group at all. Relationships that are not part of a consistency group are called stand-alone relationships. A consistency group can contain zero or more relationships. All the relationships in a consistency group must have matching master and auxiliary clusters. All relationships in a consistency group must also have the same copy direction and state.

**Remote Copy consistency group states****Inconsistent (Stopped)**

The primary VDIsks are accessible for read and write input/output (I/O) operations but the secondary VDIsks are not accessible for either. A copy process needs to be started to make the Secondary VDIsks consistent.

**Inconsistent (Copying)**

The primary VDisks are accessible for read and write I/O operations but the secondary VDisk are not accessible for either. This state is entered after a **Start** command is issued to a consistency group in the InconsistentStopped state. This state is also entered when a **Start** command is issued, with the force option, to a consistency group in the Idling or ConsistentStopped state.

**Consistent (Stopped)**

The secondary VDisks contain a consistent image, but it might be out-of-date with respect to the primary VDisks. This state can happen when a relationship was in the ConsistentSynchronized state and experiences an error which forces a freeze of the consistency group. This state can also happen when a relationship is created with the CreateConsistentFlag set to TRUE.

**Consistent (Synchronized)**

The primary VDisks are accessible for read and write I/O operations. The secondary VDisks are accessible for read-only I/O operations.

**Idling** Master VDisks and Auxiliary VDisks are operating in the primary role. Consequently the VDisks are accessible for write I/O operations.

**Idling (Disconnected)**

The VDisks in this half of the consistency group are all operating in the primary role and can accept read or write I/O operations.

**Inconsistent (Disconnected)**

The VDisks in this half of the consistency group are all operating in the secondary role and will not accept read or write I/O operations.

**Consistent (Disconnected)**

The VDisks in this half of the consistency group are all operating in the secondary role and will accept read I/O operations but not write I/O operations

**Empty**

The consistency group contains no relationships.

**Related concepts**

“Remote Copy” on page 44

Remote Copy enables you to set up a relationship between two virtual disks, so that updates that are made by an application to one virtual disk are mirrored on the other virtual disk.

---

## Configuration rules and requirements

Ensure that you understand the rules and requirements when configuring the SAN Volume Controller.

The following terms and definitions will guide you in understanding the rules and requirements.

- ISL hop. A hop on an Inter-Switch Link (ISL). With reference to all pairs of N-ports or end-nodes that are in a fabric, the number of ISL hops is the number of links that are crossed on the shortest route between the node pair whose nodes are farthest apart from each other. The distance is measured only in terms of the ISL links that are in the fabric.
- Oversubscription. The ratio of the sum of the traffic that is on the initiator N-node connections to the traffic that is on the most heavily-loaded ISLs, where more

than one ISL is in parallel between these switches. This definition assumes a symmetrical network and a specific workload that is applied equally from all initiators and sent equally to all targets. A symmetrical network means that all initiators are connected at the same level and all the controllers are connected at the same level. The SAN Volume Controller makes this calculation difficult, because it puts its back-end traffic onto the same network, and this back-end traffic varies by workload. Therefore, the oversubscription that a 100% read hit gives is different from the oversubscription that 100% write-miss gives. If you have an oversubscription of 1 or less, the network is nonblocking.

- Virtual SAN (VSAN). A VSAN is a virtual storage area network (SAN).
- Redundant SAN. A SAN configuration in which if any one component fails, connectivity between the devices that are in the SAN is maintained, possibly with degraded performance. The way to make a redundant SAN is to split the SAN into two independent counterpart SANs.
- Counterpart SAN. A non-redundant portion of a redundant SAN. A counterpart SAN provides all the connectivity of the redundant SAN, but without the redundancy. The SAN Volume Controller is typically connected to a redundant SAN that is made out of two counterpart SANs.
- Local fabric. The fabric that consists of those SAN components (switches and cables) that connect the components (nodes, hosts, and switches) of the local cluster. Because the SAN Volume Controller supports Remote Copy, significant distances might exist between the components of the local cluster and those of the remote cluster.
- Remote fabric. The fabric that consists of those SAN components (switches and cables) that connect the components (nodes, hosts, and switches) of the remote cluster. Because the SAN Volume Controller supports remote copy, significant distances might exist between the components of the local cluster and those of the remote cluster.
- Local/remote fabric interconnect. The SAN components that connect the local fabrics to the remote fabrics. These components might be single-mode optical fibres that are driven by Gigabit Interface Converters (GBICs), or they might be other, more advanced components, such as channel extenders.
- SAN Volume Controller fibre-channel port fan in. The number of hosts that can see any one port. Some controllers recommend that the number of hosts using each port be limited to prevent excessive queuing at that port. If the port fails, or the path to that port fails, the host might failover to another port, and the fan in requirements might be exceeded in this degraded mode.
- Invalid configuration. In an invalid configuration, an attempted operation will fail and will generate an error code to indicate what caused it to become invalid.
- Unsupported configuration. A configuration that might operate successfully, but for which IBM does not guarantee to be able to solve problems that might occur. Usually this type of configuration does not create an error log entry.
- Valid configuration. A configuration that is neither invalid nor unsupported.
- Degraded. A valid configuration that has had a failure, but continues to be neither invalid nor unsupported. Typically, a repair action is required to restore the degraded configuration to a valid configuration.

#### **Related tasks**

“Configuration requirements” on page 62

You *must* perform these steps before you configure the SAN Volume Controller.

#### **Related reference**



“Configuration rules”

SAN configurations that contain SAN Volume Controller clusters can be set up in various ways.

“Maximum configuration” on page 64

Ensure that you are familiar with the maximum configurations of the SAN Volume Controller.

## Configuration rules

SAN configurations that contain SAN Volume Controller clusters can be set up in various ways.

Some configurations do not work and are known as *invalid*. You can avoid creating invalid configurations if you follow the rules that are given in this section.

A SAN configuration that contains SAN Volume Controllers is valid if it observes *all* of the following rules. These rules are discussed in the following section.

### Related concepts

“Storage subsystems”

Follow these rules when planning the configuration of storage subsystems in the SAN fabric.

### Related reference

“Host bus adapters” on page 55

Follow these configuration rules for host bus adapters (HBAs).

“Nodes” on page 56

Follow these configuration rules for nodes.

“Power requirements” on page 57

Note the power requirements for the SAN Volume Controller.

“Fibre-channel switches” on page 57

Follow these guidelines for configuring the fibre-channel switches that are supported on the SAN.

## Storage subsystems

Follow these rules when planning the configuration of storage subsystems in the SAN fabric.

All SAN Volume Controller nodes of a cluster must be able to see the same set of storage subsystem ports on each device. Any operation that is in this mode in which two nodes do not see the same set of ports on the same device is degraded, and the system logs errors that request a repair action. This rule can have important effects on storage subsystem such as FASTT, which has exclusion rules that determine to which host bus adapter (HBA) WWNNs a storage partition can be mapped.

A configuration in which a SAN Volume Controller bridges a separate host device and a RAID array is not supported. Typical compatibility matrixes are shown in a document titled *Supported Hardware List* on the following Web page:

<http://www-1.ibm.com/servers/storage/support/virtual/2145.html>

The SAN Volume Controller clusters must not share its storage subsystem devices with hosts. A device can be shared with a host under certain conditions as described in this topic.

Two SAN Volume Controller clusters must not share the same storage subsystem. That is, one device cannot present LUs to two different SAN Volume Controller clusters. This configuration is not supported.

The SAN Volume Controller must be configured to manage only LUNs that are presented by supported disk controller systems. Operation with other devices is not supported.

### **Unsupported storage subsystem (generic device)**

When a storage subsystem is detected on the SAN, the SAN Volume Controller attempts to recognize it using its Inquiry data. If the device is recognized as one of the explicitly supported storage models, then the SAN Volume Controller uses error recovery programs that are potentially tailored to the known needs of the storage subsystem. If the device is not recognized, then the SAN Volume Controller configures the device as a generic device. A generic device may or may not function correctly when addressed by a SAN Volume Controller. In any event, the SAN Volume Controller does not regard accessing a generic device as an error condition and, consequently, does not log an error. MDisks presented by generic devices are not eligible to be used as quorum disks.

### **Split controller configurations**

I  
I  
I  
I  
I  
I  
If a single RAID controller presents multiple LUs, either by having multiple RAID arrays configured or by partitioning one or more RAID arrays into multiple LUs, then each LU can be owned by either SAN Volume Controller or a direct attached host. Suitable LUN masking must be in place to ensure that LUs are not shared between SAN Volume Controllers and direct attached hosts.

In a split controller configuration, a RAID array presents LUs to both a SAN Volume Controller (which treats the LU as an MDisk) and to another host. The SAN Volume Controller presents VDIs created from the MDisk to another host. There is no requirement for the pathing driver in the two hosts to be the same (although, if the RAID controller were an ESS, both hosts would use SDD). Figure 17 on page 53 shows that the RAID controller is a FASTT, with RDAC used for pathing on the directly attached host, and SDD used on the host that is attached with the SAN Volume Controller. Hosts can simultaneously access LUs, that are provided by the SAN Volume Controller and directly by the device.

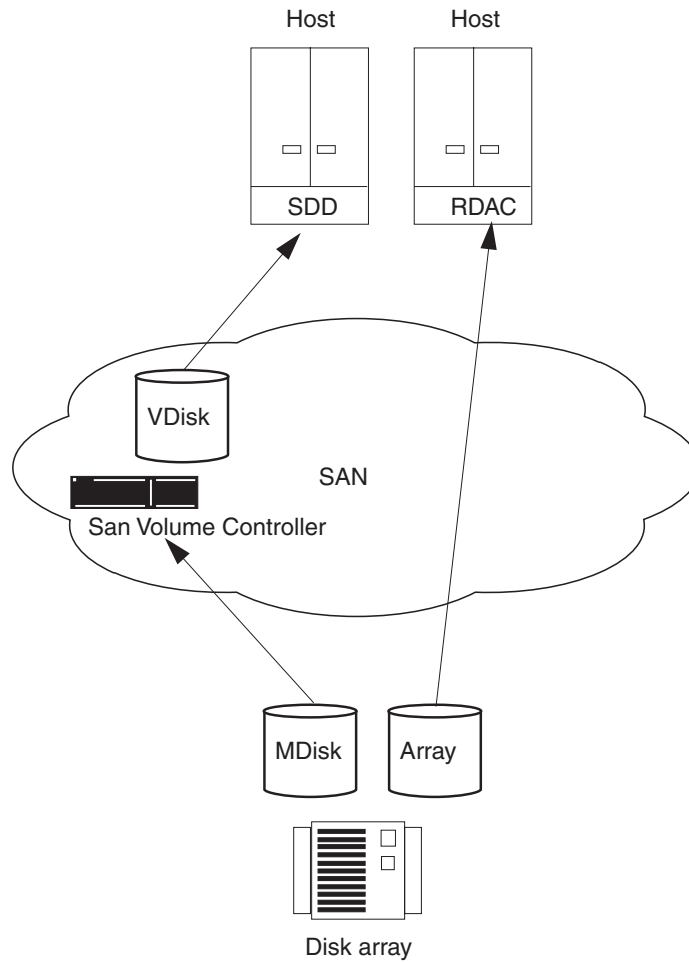

Figure 17. Disk controller system shared between SAN Volume Controller and a host

In the case where the RAID controller is an ESS, the pathing driver in the host would be IBM Subsystem Device Driver (SDD) for the ESS and SDD for the SAN Volume Controller LUs. Figure 18 on page 54 shows a supported configuration because the same pathing driver is used for both direct and virtual disks.

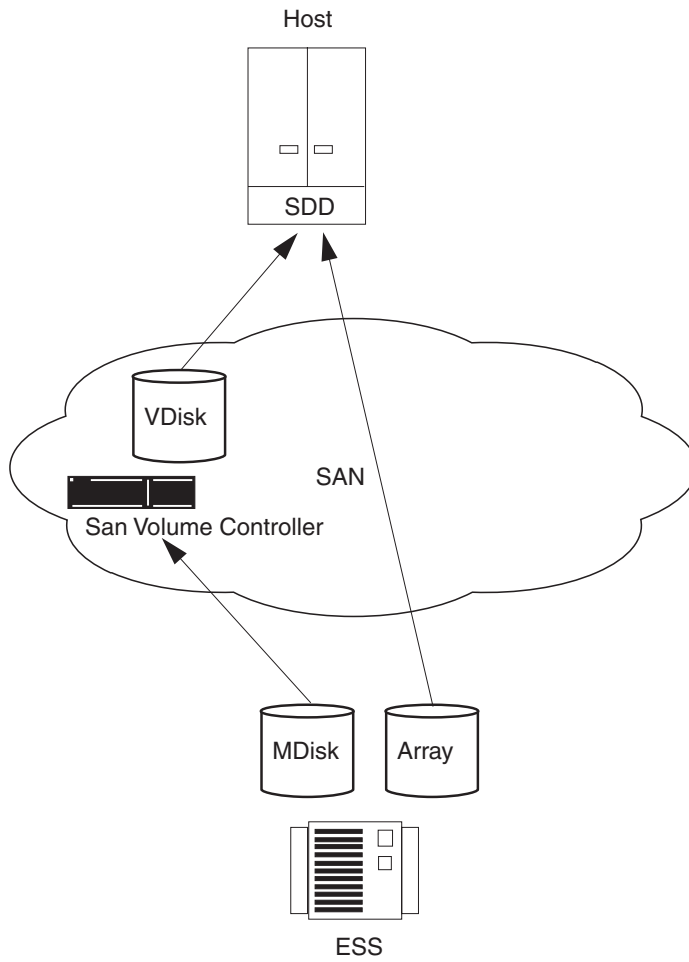

Figure 18. ESS LUs accessed directly with a SAN Volume Controller

Figure 19 on page 55 illustrates another configuration.

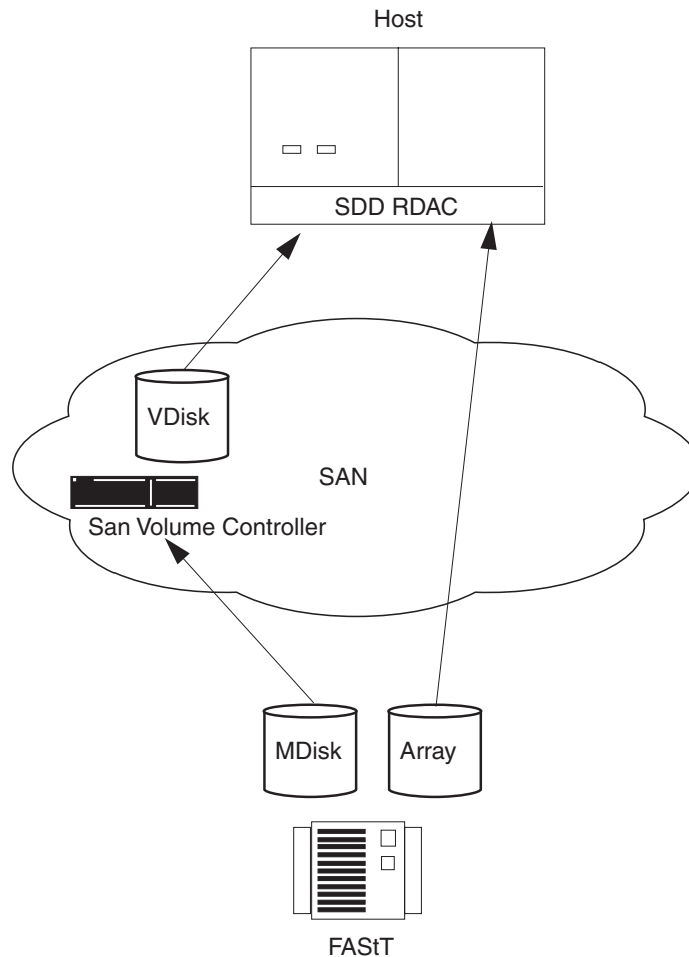

Figure 19. FAST direct connection with a SAN Volume Controller on one host

#### Related reference

“Configuration rules” on page 51

SAN configurations that contain SAN Volume Controller clusters can be set up in various ways.

#### Host bus adapters

Follow these configuration rules for host bus adapters (HBAs).

SAN Volume Controller nodes always contain two host bus adapters. Each HBA must present two ports. If an HBA fails, the configuration is still valid, and the node operates in degraded mode. If an HBA is physically removed from a SAN Volume Controller node, the configuration is not supported.

HBAs that are in dissimilar hosts or dissimilar HBAs that are in the same host must be in separate zones. For example, if you have an HP/UX® host and a Windows® 2000 server host, those hosts must be in separate zones. Here, *dissimilar* means that the hosts are running different operating systems or that they are different hardware platforms. Different levels of the same operating system are considered to be similar. This requirement ensures that different SANs can operate with each other. A configuration that breaks this requirement is not supported.

The SAN Volume Controller must be configured to export virtual disks only to host fibre-channel ports that are on the supported HBAs. See the following Web site for specific firmware levels and the latest supported hardware:

<http://www-1.ibm.com/servers/storage/support/virtual/2145.html>

Operation with other HBAs is not supported.

The number of paths from the SAN Volume Controller nodes to a host must not exceed eight. The maximum number of HBA ports must not exceed four (for example, no more than two 2-port HBAs or four 1-port HBAs). Each SAN Volume Controller node in an I/O group presents four images of a virtual disk (VDisk) onto the SAN, and each host SAN attachment has up to four HBA ports. Therefore, with more simplified zoning, the number of paths can equal up to 32: 4 SAN Volume Controller ports x 2 nodes per I/O group x 4 HBA ports. If you want to restrict the number of paths to a host, the switches should be zoned so that each HBA port is zoned with one SAN Volume Controller port for each node in the cluster. If a host has multiple HBA ports, each port should be zoned to a different set of SAN Volume Controller ports to maximize performance and redundancy.

#### **Related reference**

“Configuration rules” on page 51

SAN configurations that contain SAN Volume Controller clusters can be set up in various ways.

## **Nodes**

Follow these configuration rules for nodes.

The SAN Volume Controller nodes must always be deployed in pairs. If a node fails or is removed from the configuration, the remaining node operates in a degraded mode, but the configuration is still valid.

The uninterruptible power supply must be in the same rack as the nodes. When using 6 or 8 node support, ensure that 4 uninterruptible power supplies are used. Ensure that you are following the uninterruptible power supply support guidelines as described below:

<b>Number of nodes</b>	<b>Number of uninterruptible power supplies</b>
2	2
4	2
6	4
8	4

Support for optical connections is based on the fabric rules that the manufacturers impose for the following connection methods:

- Node to a switch
- Host to a switch
- Backend to a switch
- Switch to an Inter-Switch Link

For the SAN Volume Controller, the following optical connections are supported:

- Shortwave optical fibre
- Longwave optical fibre up to 10 KM

High-power Gigabit Interface Converters (GBICs) and longwave fibre connections beyond 10 KM are not supported.

To ensure cluster failover operations, all nodes in a cluster must be connected to the same IP subnet.

**Related reference**

“Configuration rules” on page 51

SAN configurations that contain SAN Volume Controller clusters can be set up in various ways.

**Power requirements**

Note the power requirements for the SAN Volume Controller.

The uninterruptible power supply must be in the same rack that contains the SAN Volume Controller nodes that it supplies. The combination power and signal cable for connection between SAN Volume Controller and uninterruptible power supply units is two meters long. The SAN Volume Controller and uninterruptible power supply must connect with both the power and the signal cable to function correctly.

**Related reference**

“Configuration rules” on page 51

SAN configurations that contain SAN Volume Controller clusters can be set up in various ways.

**Fibre-channel switches**

Follow these guidelines for configuring the fibre-channel switches that are supported on the SAN.

The SAN must contain only supported switches. The SAN Volume Controller supports specific IBM 2109, McData, and InRange switch models and the Cisco MDS 9000 switch and switches supported by the Cisco MDS 9000.

See the following Web site for specific firmware levels and the latest supported hardware:

<http://www-1.ibm.com/servers/storage/support/virtual/2145.html>

Operation with other switches is not supported.

Different vendor switches cannot be intermixed in the same counterpart SAN. A redundant SAN, made up of more than one counterpart SAN can contain different vendor switches, provided the same vendor is used within each counterpart SAN.

The SAN must consist of two independent switches (or networks of switches) so that the SAN includes a redundant fabric, and has no single point of failure. If one SAN fabric fails, the configuration is in a degraded mode, but it is still valid. If the SAN contains only one fabric, it is still a valid configuration, but a failure of the fabric might cause a loss of access to data. Such a SAN, therefore, is seen as a single point of failure.

Configurations with more than two SANs are not supported.

On the fibre-channel SAN, the SAN Volume Controller nodes must always and only be connected to SAN switches. Each node must be connected to each of the counterpart SANs that are in the redundant fabric. Any operation that uses direct connections between host and node, or controller and node, is not supported.

On the fibre-channel SAN, back-end storage must always and only be connected to SAN switches. Multiple connections are permitted from the redundant controllers of the back-end storage, to improve data bandwidth performance. It is not necessary to have a connection between each redundant disk controller system of the back-end storage and each counterpart SAN. For example, in a FAStT configuration in which the FAStT contains two redundant controllers, only two controller minihubs are usually used. Controller A of the FAStT is, therefore, connected to counterpart SAN A, and controller B of the of the FAStT is connected to counterpart SAN B. Any operation that uses a direct connection between the host and the controller is not supported.

The connections between the switches and the SAN Volume Controllers can operate at 1 Gbps or at 2 Gbps. All the ports for the SAN Volume Controllers that are in a single cluster, however, must run at one speed. Any operation that runs different speeds on the node-to-switch connections that are in a single cluster is not valid.

**Attention:** The default transfer rate in the SAN Volume Controller is 2 Gbps. If your environment is set up to use 1 Gbps switches, the switch rate must be set at the transfer rate.

Mixed speeds are permitted in the fabric. Lower speeds can be used to extend distances or to make use of 1 Gbps legacy components.

The switch configuration of a SAN Volume Controller SAN must observe the switch manufacturer's configuration rules. These rules might put restrictions on the switch configuration; for example, the switch manufacturer might not permit other manufacturer's switches to be in the SAN. Any operations that run outside the manufacturer's rules is not supported.

The switch must be configured so that the SAN Volume Controller nodes can see the back-end storage and the front-end HBAs. However, the front-end HBAs and the back-end storage must not be in the same zone. Any operation that runs outside these zoning rules is not supported.

Because each SAN Volume Controller has four ports, the switches can be zoned so that a particular SAN Volume Controller port is used only for internode communication, for communication to the host, or for communication to back-end storage. Whatever the configuration, each SAN Volume Controller node must remain connected to the full SAN fabric. Zoning must not be used to split the SAN into two parts.

With Remote Copy, additional zones are required that contain only the local nodes and the remote nodes. It is valid for the local hosts to see the remote nodes, or for the remote hosts to see the local nodes. Any zone that contains the local and the remote back-end storage and local nodes or remote nodes, or both, is not valid.

### **Fibre-channel switches and Inter-Switch Links**

The local or remote fabric must not contain more than three Inter-Switch Links (ISLs) hops in each fabric. Any operation that uses more than three ISLs is not supported. When a local fabric is connected to a remote fabric for Remote Copy purposes, the ISL count between a local node and a remote node must not exceed seven. Therefore, some ISLs can be used in a cascaded switch link between local and remote clusters if the internal ISL count of the local or remote cluster is less than three.



The local and remote fabric interconnections must be only one ISL hop between a switch that is in the local fabric and a switch that is in a remote fabric. That is, it must be a single-mode fibre up to 10 KM (32 810 ft.) long. Any operation that uses other local or remote fabric interconnections is not supported.

When ISLs are used, each ISL oversubscription must not exceed six. Any operation that uses higher values is not supported.

With Inter-Switch Links between nodes in the same cluster, the ISLs are considered a single point of failure. This is illustrated in Figure 20.

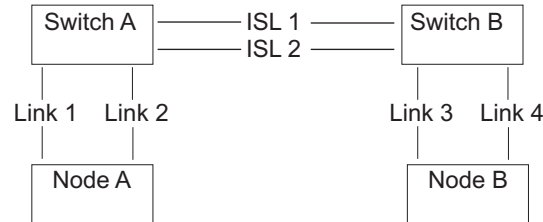

Figure 20. Fabric with Inter-Switch Links between nodes in a cluster

If Link 1 or Link 2 fails, the cluster communication does not fail.

If Link 3 or Link 4 fails, the cluster communication does not fail.

If ISL 1 or ISL 2 fails, the communication between Node A and Node B will fail for a period of time, and the node will not be recognized, even though there is still a connection between the nodes.

To ensure that a fibre-channel link failure does not cause nodes to fail when there are ISLs between nodes, it is necessary to use a redundant configuration. This is illustrated in Figure 21.

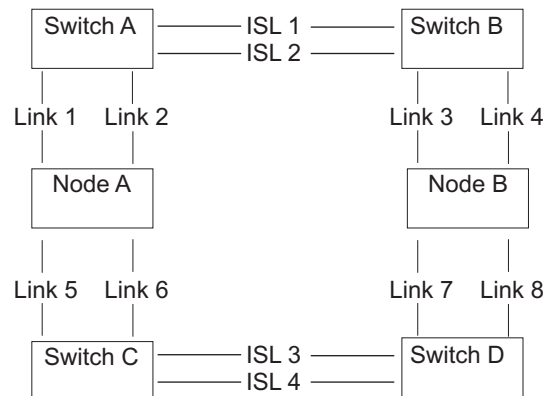

Figure 21. Fabric with Inter-Switch Links in a redundant configuration

With a redundant configuration, if any one of the links fails, then communication on the cluster will not fail.

**Related reference**

“Configuration rules” on page 51

SAN configurations that contain SAN Volume Controller clusters can be set up in various ways.

“Switch zoning for the SAN Volume Controller” on page 351  
Consider these constraints when zoning a switch.

## Configuration recommendations for large SANs

Ensure you follow the appropriate configuration recommendations for large SANs.

**When to apply these recommendations:** These configuration recommendations apply when the overall sum of the number of VDisks mapped to each server, summed over all of the servers is greater than around 1000. For example, if the configuration has 50 servers and each server addresses 20 VDisks then this section of the specification should be considered when designing the configuration.

**Purpose of these recommendations:** The purpose of these recommendations is to avoid situations where an SAN Volume Controller node reaches its maximum number of queued commands. Unfortunately many operating systems do not have helpful recovery algorithms if this situation persists for more than 15 seconds and the result will often be that one or more servers present errors to applications resulting in application failures.

### Queue depth

The queue depth is a limit on the number of I/Os which can be executed in parallel on a device. It is usually possible to set the queue depth on either the SDD vpaths (or equivalent), or the HBA. Ensure that you configure your servers to limit the queue depth on all paths to SAN Volume Controller disks in configurations that contain a large number of servers or VDisks.

### Calculating a queue depth limit

Ensure you understand the following consideration when calculating a queue depth limit.

In calculating the queue depth the following factors should be considered:

1. Although the maximum number of queued commands is per node and there are two nodes in an I/O group, the system must continue to function when one of the nodes in an I/O group is not available. Thus, consider an I/O group to have the same number of queued commands as a node.
2. If a VDisk is mapped so that it can be seen by more than one server then each server that it is mapped to may send a number of commands to it.
3. Multipathing drivers on most servers use a round robin allocation strategy to distribute I/Os amongst the available I/O paths. For servers which do not currently do this it may be the case that this behavior may change in the future and we need to avoid breaking configurations when this happens.
4. If a device driver times out a command, it will typically reissue that command almost immediately. The SAN Volume Controller will have both the original command and the retry in its command queue.

In order for the maximum queue depth not to be reached it must be the case for an I/O group that:

For all VDisks associated with the I/O group, for all servers that are mapped to be able to see each VDisk, and for all paths on each server, the sum of the queue depths must be less than 1,500.

### Homogeneous queue depth calculation

The queue depth for each VDisk should be set on the servers using the following calculation.

In systems where:

- The available queued commands are to be shared out among all paths rather than giving some servers additional resources.
- The VDIs are shared out evenly amongst the I/O groups in the cluster.

Then the queue depth for each VDisk should be set on the servers using the following calculation:

$$q = \text{round up } ((n * 1500) / (v * p))$$

q = per device path queue depth setting

n = number of I/O groups in the cluster

v = number of vdisks configured in the cluster

p= Number of paths per Vdisk.

A path is a route from a server fibre-channel port to an SAN Volume Controller fibre-channel port which is recognized by the server as giving access to the VDisk.

Example:

If you have an SAN Volume Controller cluster with 2 I/O groups and 500 VDIs. Each VDisk is mapped to two different servers. The following values will apply:

p = 2\*2 (because there are 2 paths to each VDisk on 2 separate servers. Therefore there is a total of 4 paths per VDisk.)

$$\begin{aligned} q &= \text{round up } ((2*1500) / (500*4)) \\ &= \text{round up } (1.5) \\ &= 2 \end{aligned}$$

The queue depth is not directly dependent on the number of servers. If there were 100 servers and all the disks were evenly distributed amongst those servers, each server would see  $(500 / 100) * 2 = 10$  VDIs. (They multiply by two because each VDisk is mapped to two servers.) The queue depth would be 2 per SDD vpath of the number of servers.

There are limits upon the number of VDIs which can be mapped to different operating system types.

#### **Related reference**

“Maximum configuration” on page 64

Ensure that you are familiar with the maximum configurations of the SAN Volume Controller.

### **Non-Homogeneous queue depth calculation**

The non-homogeneous queue depth for each VDisk should be set on the servers using the following calculation.

In some cases it will be appropriate to give favoured servers additional resources to allow them to queue additional commands, or the number of VDIs supported by each I/O group may be different. In these cases calculate the queue depth as follows:

**Consider each I/O group in turn:** For each VDisk, consider each server to which that VDisk has a mapping. This gives a set of (Server, VDisk) pairs. So long as the

sum of “queue depth (server, disk)” for all pairings is less than 1500, the server should not experience problems due to queue full situations.

### Limiting the queue depth

Once the appropriate queue depth limit has been determined, it must be applied.

Each operating system has an OS/HBA specific way to limit the queue depth on a per VDisk basis. An alternative to setting a limit per VDisk is to set a limit on the HBA. Thus, if the queue depth per VDisk limit is 5, the server has access to 40 VDIs through two adapters. It may be appropriate to place a queue depth limit of  $(40 \times 5) / 2 = 100$  on each adapter. This allows sharing of the queue depth allocation between VDIs.

## Configuration requirements

You *must* perform these steps before you configure the SAN Volume Controller.

1. Your IBM service representative must have installed the SAN Volume Controller.
2. Install and configure your disk controller systems and create the RAID resources that you intend to virtualize. To prevent loss of data, virtualize only those RAID that provide some kind of redundancy, that is, RAID 1, RAID 10, RAID 0+1, or RAID 5. Do *not* use RAID 0 because a single physical disk failure might cause the failure of many virtual disks. RAID 0, like other types of RAID offers cost-effective performance by using available capacity through data striping. However, RAID 0 does not provide a parity disk drive for redundancy (RAID 5) or mirroring (RAID 10).

When creating RAID with parity protection (for example, RAID 5), consider how many component disks to use in each array. The more disks you use, the fewer disks you need to provide availability for the same total capacity (one per array). However, if you use more disks, it will take longer to rebuild a replacement disk after a disk failure. If a second disk failure occurs during the rebuild period, all data on the array is lost. More data is affected by a disk failure for a larger number of member disks resulting in reduced performance while rebuilding onto a hot spare and more data being exposed if a second disk fails before the rebuild has completed. The smaller the number of disks, the more likely it is that write operations span an entire stripe (strip size x number of members minus 1). In this case, write performance is improved because the disk write operations do not have to be preceded by disk reads. The number of disk drives required to provide availability might be unacceptable if the arrays are too small.

When in doubt, create arrays with between six and eight member disks.

If reasonably small RAID arrays are used, it is easier to extend an MDisk group by adding a new RAID array of the same type. Construct multiple RAID devices of the same type, when possible.

When creating RAID with mirroring, the number of component disks in each array does not affect redundancy or performance.

Most back-end disk controller systems enable RAID to be divided up into more than one SCSI logical unit (LU). When configuring new storage for use with the SAN Volume Controller, you do not need to divide up the array. New storage should be presented as one SCSI LU. This will give a one-to-one relationship between MDisks and RAID.

**Attention:** Losing an array in an MDisk group can result in the loss of access to *all* MDisks in that group.

3. Install and configure your switches to create the zones that the SAN Volume Controller requires. One zone must contain all the disk controller systems and the SAN Volume Controller nodes. For hosts with more than one port, use

switch zoning to ensure that each host fibre-channel port is zoned to exactly one fibre-channel port of each SAN Volume Controller node in the cluster. Set up a zone on each fibre-channel switch that includes the master console and all of the SAN Volume Controller ports that are connected to that switch.

4. If you want the SAN Volume Controller to export redundant paths to disks, you must install the Subsystem Device Driver (SDD) on all of the hosts that are connected to the SAN Volume Controller. Otherwise, you will not be able to use the redundancy inherent in the configuration. Install the SDD from the following Web site:

<http://www-1.ibm.com/server/storage/support/software/sdd.html>

Version 1.4.x.x or later is required.

5. Install and configure the SAN Volume Controller master console. The communication between the master console and the SAN Volume Controller runs under a client-server network application called Secure Shell (SSH). Each SAN Volume Controller cluster is equipped with SSH Server software and the master console comes to you equipped with the SSH Client software called PuTTY. You will need to configure the SSH client key pair using PuTTY on the master console. Once you have installed your master console, you can configure and administer the SAN Volume Controller using a graphical interface or a command-line interface.
  - a. You can configure the SAN Volume Controller using the SAN Volume Controller Console Web-based application that is preinstalled on the master console.

**Note:** You can also install the master console on another machine (which you provide) using the CD-ROM provided with the master console.

- b. You can configure the SAN Volume Controller using the command-line interface (CLI) commands.
  - c. You can install an SSH client if you only want to use the CLI commands. If you want to use the CLI from a host other than the master console, ensure that the host has an SSH client installed on it.

**Note:**

- 1) AIX comes with an installed SSH client.
- 2) Linux comes with an installed SSH client.
- 3) PuTTY is recommended for Windows.

When you and the IBM service representative have completed the initial preparation steps, you must perform the following steps:

1. Add nodes to the cluster and set up the cluster properties.
2. Create managed disk groups from the managed disks to make pools of storage from which you can create virtual disks.
3. Create host objects from the HBA fibre-channel ports to which you can map virtual disks.
4. Create virtual disks from the capacity that is available in your managed disk groups.
5. Map the virtual disks to the host objects to make the disks available to the hosts, as required.
6. Optionally, create Copy Services (FlashCopy and Remote Copy) objects as required.

**Related reference**

“Configuration rules and requirements” on page 49  
 Ensure that you understand the rules and requirements when configuring the SAN Volume Controller.

## Maximum configuration

Ensure that you are familiar with the maximum configurations of the SAN Volume Controller.

Table 12 shows the maximum configuration values to consider when planning the SAN Volume Controller installation.

Table 12. SAN Volume Controller maximum configuration values

Objects	Maximum number	Comments
Cluster Properties		
Nodes	8	Arranged as four I/O groups.
I/O groups	4	Each containing two nodes.
MDisk group	128	-- --
MDisks	4096	Represents an average of 64 per controller.
Object MDisks per MDisk group	128	-- --
MDisk size	2 TB	Defined by 32-bit LBA limit.
Addressability	2.1 PB	Maximum extent size 512 MB, arbitrary limit of 2 <sup>22</sup> extents in map.
LU size	2 TB	Defined by 32-bit LBA limit.
Concurrent SCSI tasks (commands) per node	2500	-- --
Concurrent commands per node	2500	Assumes a backend latency of 100 ms.
Concurrent commands per FC port	2048	-- --
SDD	512 SAN Volume Controller vpaths per host	<p>One vpath is created for each VDisk mapped to a host. Although the SAN Volume Controller only permits 512 VDIs to be mapped to a host, the SDD limit can be exceeded by either:</p> <ul style="list-style-type: none"> <li>• Creating two (or more) host objects for one physical host and mapping more than 512 VDIs to the host using the multiple host objects.</li> <li>• Creating two (or more) clusters and mapping more than 512 VDIs to the host using the multiple clusters.</li> </ul> <p><b>Note:</b> Both of these operations are unsupported.</p>
VDIs per MDisk Group		Cluster limit applies.
Front-end Properties		
SAN ports	256	Maximum size of fabric, including all SAN Volume Controller nodes.

Table 12. SAN Volume Controller maximum configuration values (continued)

Objects	Maximum number	Comments
Fabrics	2	Dual fabric configurations.
Host IDs per cluster	64	A host ID is associated with a map table that associates SCSI LUNs with VDisks. It is also associated with one or more host worldwide port names.
Host ports per cluster	128	Up to 128 distinct host worldwide port names are recognized.
Host LUN size	2 TB	Defined by 32-bit LBA limit.
Virtual disks (VDisks)	4096	Includes managed-mode VDisks and image-mode VDisks.
VDisks per I/O group	1024	-- --
VDisks per host ID	512	The limit may be different based on host operating system.
VDisks-to-host mappings	20 000	-- --
Maximum persistent reservation keys	132 000	-- --
<b>Back-end Properties</b>		
Managed Disks (MDisks)	4096	Represents an average of 64 per world wide node name.
Back-end Storage WWNNs	64	Maximum number of device fabric world wide node name.
Back-end Storage WWPNS	256	16 ports per controller
LUs per back-end WWNN	4096	Maximum of 512 LUs presented for each world wide node name.
WWNNs per subsystem	4	-- --
WWPNs per WWNN	16	The maximum number of ports per world wide node name.
Preferred ports per subsystem	4	
<b>Copy Services Properties</b>		
Remote Copy relationships	4096	-- --
Remote Copy consistency groups	256	-- --

Table 12. SAN Volume Controller maximum configuration values (continued)

Objects	Maximum number	Comments
Remote Copy VDisk per I/O group	16 TB	-- --
FlashCopy mappings	2048 (See Note.)	-- --
FlashCopy consistency groups	128	-- --
FlashCopy VDisk per I/O group	16 TB	-- --
Note: SAN Volume Controller supports up to 512 FlashCopy mappings per consistency group.		

**Related reference**

“Configuration rules and requirements” on page 49  
 Ensure that you understand the rules and requirements when configuring the SAN Volume Controller.

---

## Supported fibre-channel extenders

The SAN Volume Controller supports the CNT UltraNet Edge Storage Router to support synchronous copy services.

The maximum one-way latency supported is 10 microseconds when using Brocade fabric, and 34 microseconds when using McData fabric. The relationship between latency and distance is dependent on the network and number of hops. The distance is approximately 100-150 kilometers per microsecond.

**Note:** Performance of copy services degrades as the distance increases.

See the following Web site for the latest supported hardware:

<http://www-1.ibm.com/servers/storage/support/virtual/2145.html>

**Related concepts**

“Performance of fibre-channel extenders”  
 When planning to use fibre-channel extenders, it is important to be aware that the performance of the link to the remote location decreases as the distance to the remote location increases.

## Performance of fibre-channel extenders

When planning to use fibre-channel extenders, it is important to be aware that the performance of the link to the remote location decreases as the distance to the remote location increases.

For fibre-channel IP extenders, throughput is limited by latency and bit error rates. Typical I/O latency can be expected to be 10 microseconds per kilometer. Bit error rates will vary depending on the quality of the circuit provided.



You should review the total throughput rates that might be expected for your planned configuration with the vendor of your fibre-channel extender and your network provider.

**Related reference**

“Supported fibre-channel extenders” on page 66

The SAN Volume Controller supports the CNT UltraNet Edge Storage Router to support synchronous copy services.



---

## Chapter 2. Preparing to configure the SAN Volume Controller

Once you've completed the two phase creation of the cluster, you can begin to configure the SAN Volume Controller.

Fundamentally, the configuration of the SAN Volume Controller begins by completing a two phase creation (initialization) of the cluster. The first phase is performed from the front panel of the cluster. The completion of the creation of the cluster is performed from the SAN Volume Controller Console which is accessible from a Web server running on the master console.

### **Related tasks**

“Create cluster from the front panel”

After you have created a pair of nodes, you can now create a cluster from the front panel.

### **Related reference**

“Master console security overview” on page 72

There are several passwords and IDs that have been set to default values in manufacturing that need to be changed on the master console.

---

## Create cluster from the front panel

After you have created a pair of nodes, you can now create a cluster from the front panel.

Ensure that the SAN Volume Controller nodes are installed. Prior to configuring the cluster, should you choose to have the customer engineer (CE) initially create the cluster, ensure that you have supplied the following information to your customer engineer:

1. Ensure that you have the correct license. The license will show you whether you are permitted to use flash copy or remote copy. It will also show how much virtualization you are permitted to use.
2. You must supply the following information to enable the customer engineer to start the configuration procedure:
  - Cluster IP address. This address must be unique, otherwise communication problems can occur.
  - Subnet mask
  - Gateway IP address

The customer engineer uses the front panel of the SAN Volume Controller to enter the information that you have supplied. The SAN Volume Controller generates a random password on the display panel that the customer engineer will give to you.

3. Make a note of the password and the IP address. You need it when you connect to the web application program to create the cluster.

Ensure that you have a new pair of nodes and you want to make a cluster. You also want to gain access to this cluster to start your configuration. The steps are as follows:

1. Choose a node and create a new cluster.
2. Set the IP addresses so you can gain access to the cluster.
3. Configure your cluster.

1. Choose any node that is to become a member of the cluster that you are creating.
2. At the IBM TotalStorage SAN Volume Controller service panel, keep pressing and releasing the up or down navigation button until Node: is displayed.
3. Keep pressing and releasing the left or right navigation button until Create Cluster? is displayed.
4. Press the **Select** button.
  - If IP Address: is displayed on line 1 of the screen, go to step 5.
  - If Delete Cluster? is displayed in line 1 of the service display screen, this node is already a member of a cluster. Either you have selected the wrong node, or you have already used this node in an existing cluster. The ID of this existing cluster is displayed in line 2 of the service display screen.
    - If you selected the wrong node you can exit this procedure now. The procedure cancels automatically after 60 seconds.
 

**Attention:** When a node is deleted from a cluster, all customer data that is contained in that node is lost.

 If you are sure that the existing cluster is not required:
      - a. Press and hold the up button.
      - b. Press and release the select button. The node will be restarted. Once the node has been restarted you must then restart this procedure from step 1. IP Address: is displayed on the service display screen.
      - c. Go to step 5.
5. **Changing the fibre channel port speed** To display the menu that shows the current value of the fibre channel speed setting for the node, press and hold the down button. Then press the select button when the display is showing the status of one of the fibre channel (FC) ports. The setting should be either 1 Gb or 2 Gb. To change the setting, perform the following steps:
  - a. Press the up or down buttons to select the speed.
  - b. Press the select button when the speed you want is displayed.

This action changes the speed of all the fibre channel ports on the node.
6. Press the select button.
7. Use the up or down navigation button to change the value of the first field of the IP Address to the value that you have chosen.
8. Use the right navigation button to move to the next field. Use the up or down navigation buttons to change the value of this field.
9. Repeat step 8 for each of the remaining fields of the IP Address.
10. When you have changed the last field of the IP Address, press the select button.
11. Press the right button. Subnet Mask: is displayed.
12. Press the select button.
13. Change the fields for Subnet Mask in the same way that you changed the fields for IP Address.
14. When you have changed the last field of Subnet Mask, press the select button.
15. Press the right navigation button. Gateway: is displayed.
16. Press the select button.
17. Change the fields for Gateway in the same way that you changed the fields for IP Address.
18. When you have changed the last field of Gateway, press the select button.

19. Keep pressing and releasing the right-hand navigation button until Create Now? is displayed.
20. If you are satisfied with your settings, press the select navigation button.  
If you want to review your settings before you create the cluster, use the right and left buttons to review those settings. Make any necessary changes, return to Create Now?, then press the select button.  
If the cluster is created successfully, Password: is displayed in line 1 of the service display screen. Line 2 contains a password that you can use to access the cluster. Make a note of this password now. The password is displayed for only 60 seconds, or until the up, down, left or right navigation button is pressed.  
**Attention: If you do not record the password, you will have to start the cluster configuration procedure again.** When the password has been recorded, press the up, down, left, or right navigation button to delete the password from the screen.
21. If the cluster is created successfully:
  - a. Cluster: is displayed in line 1 of the service display screen,
  - b. the cluster IP address is displayed on line 2,
  - c. and you have successfully completed the creating a cluster process.

#### Related information

Chapter 2, “Preparing to configure the SAN Volume Controller,” on page 69  
Once you’ve completed the two phase creation of the cluster, you can begin to configure the SAN Volume Controller.

“Scenario: typical usage for the SAN Volume Controller Console” on page 118  
This hypothetical example describes a scenario for configuring the SAN Volume Controller using the SAN Volume Controller Console.

---

## Overview of passwords

Passwords must be set when using the master console.

The following passwords must be set:

- **Windows user ID and password:** Use the Computer Management Administrative tool to change the user ID and passwords. To access this tool, select **Start → Settings → Control Panel** and double-click **Administrative Tools → Computer Management → Local Users and Groups** from the left-hand navigation.

#### Note:

1. Any new user ID generated must have administrator privileges, if it is to function with all of the master console software.
  2. When the Windows password is changed, you also need to make changes to Tivoli’s Websphere Administrator password because it is used to authorize access.
- When you change the Administrator password, you will need to perform the following steps:
    1. Ensure that the file, C:\Support Utils\ChangeWASAdminPass.bat, is present on your system.  
If the file is not present, download it into the C:\Support Utils directory. The file can be downloaded from the following Web site:  
<http://www.ibm.com/storage/support/2145>

2. Open a command prompt window by selecting **Start → Programs → Accessories → Command Prompt**.
  3. Type `cd C:\Support Utils`
  4. Type `ChangeWASAdminPass Administrator <NewPassWord>`
  5. Restart the master console.
- Set the **SAN Volume Controller user ID and password**: using the SAN Volume Controller Web pages accessed using a Web browser or using the SAN Volume Controller Console.

**Note:** If you forget your Superuser password, you must contact IBM Service.

These internally used IDs and passwords can also be changed if required.

#### **DB2 user IDs and passwords:**

- **Base User ID = db2admin:** use the Computer Management Administrative tool to change this password. To access this tool, select **Start → Settings → Control Panel** and click **Administrative Tools → Computer Management → Local Users and Groups** from the left-hand navigation.
- **Database user used by Tivoli SAN Manager = ITSANM** use the Computer Management Administrative tool to change this password. See *IBM Tivoli Storage Area Network Manager: User's Guide* for more information.

**Tivoli SAN Manager Host Authorization password:** The Tivoli SAN Manager Host Authorization password is used by both the Tivoli SAN Manager and its agents. This password is required to ensure that both the Tivoli SAN Manager and its agents can communicate with each other. See *IBM Tivoli Storage Area Network Manager: User's Guide* for more information about how to change this password.

#### **Related tasks**

“Maintaining cluster passwords using the” on page 158

To maintain cluster passwords using the SAN Volume Controller Console, complete these steps.

#### **Related reference**

“Master console security overview”

There are several passwords and IDs that have been set to default values in manufacturing that need to be changed on the master console.

#### **Related information**

Chapter 2, “Preparing to configure the SAN Volume Controller,” on page 69

Once you've completed the two phase creation of the cluster, you can begin to configure the SAN Volume Controller.

“Using the Command-Line Interface (CLI)” on page 169

The SAN Volume Controller cluster Command-Line Interface (CLI) is a collection of commands you can use to manage the SAN Volume Controller.

“Using the SAN Volume Controller Console” on page 101

The SAN Volume Controller is provided with a console that is Web-browser based. It is known as the SAN Volume Controller Console.

## **Master console security overview**

There are several passwords and IDs that have been set to default values in manufacturing that need to be changed on the master console.

**Note:** It is important to change the default passwords to maintain the security of the master console. It might be necessary to provide some passwords to a

Customer Engineer who is servicing your system, including the Administrator password. Alternatively, you might elect to physically type the passwords yourself when required.

**Related reference**

“Overview of passwords” on page 71

Passwords must be set when using the master console.

---

## Master console

The SAN Volume Controller provides a master console that can be used as a single platform to configure, manage, and service the SAN Volume Controller.

The master console allows system administrators to integrate rapidly the SAN Volume Controller into their environment. The master console monitors the configuration of the whole system and all of the internal components. It offers a standard and central location for all aspects of the operation, including SAN topology rendering, SNMP trap management, Call Home (Service Alert) and Remote Service facilities, as well as all the configuration and diagnostic utilities for the components.

**Note:** VPN connection is required for Remote Service facilities.

The master console provides the following functions:

- Browser support for:
  - SAN Volume Controller Console
  - Fibre-channel switch
- CLI configuration support using Secure Shell (SSH)
- SAN Topology rendering using Tivoli® SAN Manager
- Remote Service capability through VPN
- IBM Director
  - SNMP Trap management
  - Call Home (Service Alert) capability
  - E-mail notification to the customer, for example, to the system administrator

**Related tasks**

“Validating the truststore certificate expiration” on page 74

In order to successfully log onto the master console, you must ensure that you have a valid truststore certificate.

“Configuring the master console” on page 75

Ensure that you are familiar with the necessary steps to complete in order to configure the master console.

“Configuring the network” on page 76

Ensure that you are familiar with configuring the network. The following topics provide step-by-step instructions for configuring the network and setting up your environment.

“Configuring the browser” on page 78

Before using the SAN Volume Controller, ensure that the browser is not set to prevent new windows from automatically opening when you visit a Web site. These are known as “pop-ups.”

“Configuring the master console host name” on page 84

If you have changed the host name of the master console, you must modify

some of the IBM WebSphere Application Server files that are used by the SAN Volume Controller Console and Tivoli SAN Manager.

“Starting the Tivoli SAN Manager” on page 85

Ensure that you configure the ITSANM to meet your requirements.

“Setting up Remote Support” on page 86

To set up Remote Support for the master console, complete these tasks.

“Configuring IBM Director for the SAN Volume Controller Call-Home and Event Notification” on page 89

Ensure that you configure IBM Director for the SAN Volume Controller error notification and Call-Home.

“Connecting to the Remote Support Center” on page 95

You can connect the master console to the Remote Support Center.

“Clearing the Windows™ event logs” on page 95

Configuring the master console might cause a number of log entries in the Windows event logs.

#### **Related reference**

“Configuring the Secure Shell (SSH) client system” on page 80

Ensure that you configure the Secure Shell (SSH) client system to set up your environment.

“IBM Director” on page 88

IBM Director is a systems-management solution that helps administrators manage single or large groups of IBM and non-IBM devices.

“Upgrading software on the master console” on page 94

The software on the master console may need to be upgraded from time to time.

#### **Related information**

“Secure Shell (SSH)” on page 78

Secure Shell (SSH) is a client-server network application.

“Troubleshooting master console problems” on page 96

If you experience problems with the master console, ensure that you perform the appropriate troubleshooting procedures.

“Installing antivirus software” on page 98

In order to protect your workstations and your enterprise, install the latest patches for your Windows operating system and the latest levels of your antivirus software on the master console.

## **Validating the truststore certificate expiration**

In order to successfully log onto the master console, you must ensure that you have a valid truststore certificate.

When signing onto the master console, you might receive a message similar to the following:

CMMUI8304E The Administrative server is unable to find a valid certificate in the truststore file.

This message is displayed when a certificate in the truststore file expires. The Administrative server uses the certificates in the truststore file to create a secure connection with the CIM agent. Because the Administrative server cannot find a valid certificate for the CIM agent in the truststore file, no authentication can occur.



To resolve the problem you must verify that the truststore file was created correctly. If you have any problems, contact your service representative.

Perform the following steps to regenerate a truststore certificate:

1. Go to the C:\Program Files\IBM\svccconsole\cimom directory.
2. Double-click on the **mkcertificate.bat** file. A "Generating Certificates" message is displayed. The new certificate is generated and stored in the C:\Program Files\IBM\svccconsole\cimom directory.
3. Copy the truststore file to the following sub directories:

**Note:** Each directory begins with C:\Program Files\IBM\svccconsole\console\embeddedWAS...

C:\...\config\cells\DefaultNode\applications\  
ICAConsole.ear\deployments\ICAConsole\ICAConsole.war\  
WEB-INF

C:\...\config\cells\DefaultNode\applications\  
SVCConsole.ear\deployments\SVCConsole\SVCConsole.war\  
WEB-INF

C:\...\config\installedApps\DefaultNode\  
ICAConsole.ear\ICAConsole.war\WEB-INF

C:\...\config\installedApps\DefaultNode\  
SVCConsole.ear\SVCConsole.war\WEB-INF

4. Stop and then restart the following applications. The following services are located in **Start -> Settings -> Control Panel -> Administrative Tools -> Component Services**.

- IBM CIM Object Manager
- IBM WebSphere Application Server V5 - SVC

To stop and then restart the services, right-click on the application and select **Stop**, then **Start**.

**Note:** If the command times-out when stopping the IBM WebSphere application, you can restart the master console as this will restart the application as well.

5. Ensure that both applications are running again. Launch the SAN Volume Controller Console and logon.

#### **Related reference**

"Master console" on page 73

The SAN Volume Controller provides a master console that can be used as a single platform to configure, manage, and service the SAN Volume Controller.

## **Configuring the master console**

Ensure that you are familiar with the necessary steps to complete in order to configure the master console.

1. Log on to the master console.
2. Configure the network.
3. Configure the browser.
4. Generate an SSH key pair using the SSH client called PuTTY.
5. Configure the PuTTY session for command-line interface (CLI) access only.

6. Start the SAN Volume Controller Console for the SAN Volume Controller.
7. Store the master console SSH public key file on each SAN Volume Controller cluster.
8. Configure the master console host name.
9. Set up a new zone on the fibre-channel switches that includes the master console and all of the 2145 ports.
10. Start the Tivoli SAN Manager.
11. Set up Remote Support.
12. Start IBM Director.
13. Modify your IBM Director Settings.
14. Configure your IBM Director for the SAN Volume Controller Call-Home and Event Notification.
15. Upgrade software on the master console.
16. Install anti-virus software

#### **Related tasks**

“Configuring the PuTTY session for the command-line interface” on page 82  
If you are preparing to run the CLI from the master console, you will need to configure the PuTTY session on the SSH client system.

“Modifying your IBM Director settings” on page 88  
Ensure that you modify your IBM Director settings to set up your master console environment.

“Adding subsequent SSH public keys to the SAN Volume Controller” on page 160

During the cluster creation wizard, you will have added an SSH key to the cluster that allows the master console (where the SAN Volume Controller is running) to access the cluster. If you wish to add more SSH keys, that is, grant SSH access to other servers you need to follow the procedure below.

“Generating an SSH key pair using the SSH client called PuTTY” on page 81  
These are step-by-step instructions for generating SSH keys on the PuTTY SSH client system.

#### **Related reference**

“Accessing the SAN Volume Controller Console” on page 102  
You access the SAN Volume Controller Console by pointing a Web browser at a URL.

“Master console” on page 73  
The SAN Volume Controller provides a master console that can be used as a single platform to configure, manage, and service the SAN Volume Controller.

## **Configuring the network**

Ensure that you are familiar with configuring the network. The following topics provide step-by-step instructions for configuring the network and setting up your environment.

#### **Related tasks**

“Connecting to the Local Area Connection on the master console” on page 77  
There are two Local Area Connections. Local Area Connection 1 and Local Area Connection 2.

“Setting up the host name” on page 77  
Ensure that you set up the host name to configure your environment.

## Connecting to the Local Area Connection on the master console

There are two Local Area Connections. Local Area Connection 1 and Local Area Connection 2.

Local Area Connection 1 on the master console is used for Remote Support. If you require Remote Support you will need to configure the IP address settings for the Ethernet port.

Local Area Connection 2 is used to communicate to devices on the internal network and must be configured with an IP address. Perform steps 9 - 16 to enter the master console IP address for the Local Area Connection 2.

1. Right-click **My Network Places** icon.
2. Select **Properties**.
3. Right-click **Local Area Connection 1** option.
4. Select **Properties**.

**Note:** You may disable the Local Area Connection 1 while you are not using Remote Support.

5. Select **Internet Protocol (TCP/IP)**.
6. Select **Properties**.
7. Enter all required information for the IP and DNS addresses.
8. Connect Ethernet port-1 to the network.
9. Right-click **My Network Places** icon.
10. Select **Properties**.
11. Right-click **Local Area Connection 2** option.
12. Select **Properties**.
13. Select **Internet Protocol (TCP/IP)**.
14. Select **Properties**.
15. Enter all required information for the IP and DNS addresses.
16. Connect Ethernet port-2 to the network.

### Related tasks

“Configuring the network” on page 76

Ensure that you are familiar with configuring the network. The following topics provide step-by-step instructions for configuring the network and setting up your environment.

“Setting up Remote Support” on page 86

To set up Remote Support for the master console, complete these tasks.

## Setting up the host name

Ensure that you set up the host name to configure your environment.

1. Enter the master console name. To do this, right-click **My Computer**.
2. Select **Properties**.
3. Select the **Network Identification** tab.
4. Select **Properties**.
5. Enter the master console name in the Computer name field.
6. Select the **More** button.
7. Enter the full path information in the Primary DNS suffix of this computer field.

The master console must now be restarted.

### Related tasks

“Configuring the network” on page 76

Ensure that you are familiar with configuring the network. The following topics provide step-by-step instructions for configuring the network and setting up your environment.

“Configuring the master console host name” on page 84

If you have changed the host name of the master console, you must modify some of the IBM WebSphere Application Server files that are used by the SAN Volume Controller Console and Tivoli SAN Manager.

## Configuring the browser

Before using the SAN Volume Controller, ensure that the browser is not set to prevent new windows from automatically opening when you visit a Web site. These are known as “pop-ups.”

- Ensure that the browser is not set to block or suppress popup windows, if your browser includes this feature.
- Do not install applications on the browser that block or suppress popup windows. If such an application is installed with the browser, uninstall it or turn it off.

### Related reference

“Master console” on page 73

The SAN Volume Controller provides a master console that can be used as a single platform to configure, manage, and service the SAN Volume Controller.

## Secure Shell (SSH)

Secure Shell (SSH) is a client-server network application.

### Overview

The SAN Volume Controller cluster acts as the SSH server in this relationship. The SSH client provides a secure environment in which to connect to a remote machine. It uses the principles of public and private keys for authentication.

SSH keys are generated by the SSH software. This includes a public key, which is uploaded and maintained by the cluster and a private key that is kept private to the host that is running the SSH client. These keys authorize specific users to access the administration and service functions on the cluster. Each key is associated with a user-defined ID string that can consist of up to 40 characters. Up to 100 keys can be stored on the cluster. You can also add new IDs and keys or delete unwanted IDs and keys.

### CAUTION:

**The SAN Volume Controller does not support the running of multiple SSH sessions concurrently against a single cluster. This impact may take the form of loss of access to data and in extreme circumstances possibly even data loss. In order to avoid running multiple concurrent SSH sessions against a single cluster, avoid running scripts which create child processes running in the background, which invoke SAN Volume Controller commands.**

Secure Shell (SSH) is a communication vehicle between the host system and either:

- the SAN Volume Controller command-line interface (CLI)
- or the system on which the SAN Volume Controller Console is installed.

## Authenticating SSH logins

When you are using AIX hosts, SSH logins are authenticated on the cluster using the RSA-based authentication that is supported in the OpenSSH client available for AIX. This scheme is based on public-key cryptography, using a scheme known commonly as RSA.

**Note:** The authentication process for non-AIX hosts systems is similar.

With this scheme (as in similar OpenSSH systems on other host types) the encryption and decryption is done using separate keys. This means it is not possible to derive the decryption key from the encryption key.

Because physical possession of the private key allows access to the cluster, the private key must be kept in a protected place, such as the .ssh directory on the AIX host, with restricted access permissions.

When an SSH client (A) attempts to connect to an SSH server (B), the key pair is needed to authenticate the connection. The key consists of two halves: the public and private keys. The SSH client public key is put onto the SSH Server (B) using some means outside of the SSH session. When the SSH client (A) tries to connect, the private key on the SSH client (A) is able to authenticate with its public half on the SSH server (B).

## Running the command-line interface (CLI)

In order to use the command-line interface (CLI) or SAN Volume Controller Console system you must have an SSH client installed on that system and perform the following tasks:

- Generate the SSH key pair on the client system.
- Store the private key from this key pair on the client system.
- Store the SSH public key for the client on the SAN Volume Controller clusters.

The master console has the SSH client software called PuTTY preinstalled. This software provides the Secure Shell (SSH) client function for users logged into the master console who wish to invoke the SAN Volume Controller command-line interface (CLI).

If you wish to run the SAN Volume Controller command-line interface (CLI) from a different system than the master console, you must install an SSH client. For your convenience, the installation program to install the PuTTY software on Windows can be found in the SSH client directory of the SAN Volume Controller Console CD-ROM. You can generate SSH public and private keys using the PuTTY software. You must store the SSH Client public key on all SAN Volume Controller clusters.

## Connecting the SAN Volume Controller Console to additional clusters

The master console also has the SAN Volume Controller Console Web server and Common Information Model (CIM) Object Man

### Related reference

“Master console” on page 73

The SAN Volume Controller provides a master console that can be used as a single platform to configure, manage, and service the SAN Volume Controller.

## Configuring the Secure Shell (SSH) client system

Ensure that you configure the Secure Shell (SSH) client system to set up your environment.

The related topics elaborate on each step to configure a PuTTY Secure Shell client system. IBM has preinstalled the PuTTY Secure Shell client software on the master console. You can also install PuTTY on any Windows 2000 server where you will run the command-line interface (CLI) or where you install the SAN Volume Controller Console. If you have some other Secure Shell client software to run on another host, follow that software documentation to perform the tasks equivalent to the following steps.

1. Install SSH client software(not required for master console which has PuTTY preinstalled).
2. Generate SSH keys on the SSH client system.
3. Configure the PuTTY session, if required, on the SSH client system.
4. If client system is the master console, copy the private key into the SAN Volume Controller install directory; if the client system is not the master console, store the private key on the SSH client system.

### CAUTION:

**The SAN Volume Controller does not support the running of multiple SSH sessions concurrently against a single cluster. This impact may take the form of loss of access to data and in extreme circumstances possibly even data loss. In order to avoid running multiple concurrent SSH sessions against a single cluster, avoid running scripts which create child processes running in the background, which invoke SAN Volume Controller commands.**

5. Copy the SSH public key to the master console.
6. Store the SSH client public key on the SAN Volume Controller cluster.

You will perform step 6 to store the SSH client public key on the SAN Volume Controller when you complete the creation of the SAN Volume Controller cluster. Once you have defined a cluster to the SAN Volume Controller Console and have therefore enabled SSH communication to the cluster, you can store additional SSH client public keys on the cluster. You can store additional keys through the SAN Volume Controller Console or the Command-Line Interface.

### Related tasks

“Generating an SSH key pair using the SSH client called PuTTY” on page 81  
These are step-by-step instructions for generating SSH keys on the PuTTY SSH client system.

“Configuring the PuTTY session for the command-line interface” on page 82  
If you are preparing to run the CLI from the master console, you will need to configure the PuTTY session on the SSH client system.

“Adding subsequent SSH public keys to the SAN Volume Controller” on page 160

During the cluster creation wizard, you will have added an SSH key to the cluster that allows the master console (where the SAN Volume Controller is running) to access the cluster. If you wish to add more SSH keys, that is, grant SSH access to other servers you need to follow the procedure below.

“Storing SSH keys in the SAN Volume Controller Console” on page 82

When the keys that are used to communicate with the SAN Volume Controller are changed, you must store a copy of the new private key in the SAN Volume Controller Console.

### Related reference

“Maintaining SSH public keys” on page 83  
You can maintain secure shell (SSH) public keys on the cluster from the Maintain SSH Public Keys panel.

## Generating an SSH key pair using the SSH client called PuTTY

These are step-by-step instructions for generating SSH keys on the PuTTY SSH client system.

1. Start the PuTTY Key Generator to generate public and private keys for SSH client connection to the SSH Server on the SAN Volume Controller cluster. Select **Start -> Programs -> PuTTY -> PuTTYgen** to open the PuTTY Key Generator Graphical User Interface (GUI) window.
2. Use the PuTTY Key Generator GUI window to generate keys:
  - a. Select the **SSH2 RSA** radio button.
  - b. Leave the number of bits in a generated key value at 1024.
  - c. Click **Generate**.

A message similar to the following is displayed:

Please generate some randomness by moving the mouse over the blank area.

in the section of the GUI labeled Key. The *blank area* indicated by the message is the large blank rectangle on the GUI inside the section of the GUI labeled Key. Continue to move the cursor over the blank area until the progress bar reaches the far right. This generates random characters to create a unique key.

**Attention:** Do not enter anything in **Key Passphrase** or **Confirm passphrase** fields.

3. Save the generated SSH keys on your system disk for later use. Two files are generated.
  - a. Click **Save public key**. You will be prompted for a name and location for the key. Remember the name and location of the SSH public key you save.

### Note:

- 1) For AIX, store the key in the \$HOME/.ssh directory.
  - 2) It is recommended that you use the term pub in naming the public key, for example, pubkey, to easily differentiate the SSH public key from the SSH private key. You will identify the name and location of the SSH public key to the SAN Volume Controller cluster in a later step.
- b. Click **Save Private key**. You will be prompted with a message similar to the following:

Are you sure you want to save this key without a passphrase to protect it?  
Yes/No

**Note:** For AIX, store the key in the \$HOME/.ssh directory, in the \$HOME.ssh/identity file. In the simplest cases, this involves replacing the contents of the identity file with the contents of the key file. However, when using multiple keys, then all of these keys must appear in the identity file.

4. Close the PuTTY Key Generator.

### Related reference

“Configuring the Secure Shell (SSH) client system” on page 80  
Ensure that you configure the Secure Shell (SSH) client system to set up your environment.

## Configuring the PuTTY session for the command-line interface

If you are preparing to run the CLI from the master console, you will need to configure the PuTTY session on the SSH client system.

### CAUTION:

**The SAN Volume Controller does not support the running of multiple SSH sessions concurrently against a single cluster. This impact may take the form of loss of access to data and in extreme circumstances possibly even data loss. In order to avoid running multiple concurrent SSH sessions against a single cluster, avoid running scripts which create child processes running in the background, which invoke SAN Volume Controller commands.**

1. Click **Start -> Programs -> PuTTY -> PuTTY** to open the PuTTY Configuration interface window. The items you select in the Category pane on the left side of the window affect the content in the right pane of the window.
2. In the Category pane, click **Session**.
3. Click **SSH**.
4. In the Connection tree, click **Connection -> SSH**. This will bring up a different view in the right pane.
5. Ensure that the button labeled **2** is selected.
6. In the SSH tree, click **Auth**. A different view opens in the right pane.
7. In the **Private key file for authentication** field in the Authentication Parameters section, type the name of the SSH client private key file that you specified when you used the PuTTY Key Generator. This field is in the second section of the right pane. You can either click **Browse** to select the file name from the system directory or, alternatively, type the fully qualified file name (for example, C:\Support Utils\PuTTY\priv.ppk).
8. In the Category pane, click **Session**.
9. In the Load, save or delete a stored session section in the right pane, click **Default Settings -> Save** in the **save or delete a stored session** field.

### Related tasks

“Configuring the master console” on page 75  
Ensure that you are familiar with the necessary steps to complete in order to configure the master console.

### Related reference

“Configuring the Secure Shell (SSH) client system” on page 80  
Ensure that you configure the Secure Shell (SSH) client system to set up your environment.

## Storing SSH keys in the SAN Volume Controller Console

When the keys that are used to communicate with the SAN Volume Controller are changed, you must store a copy of the new private key in the SAN Volume Controller Console.

1. Open a command prompt window by clicking **Start -> Run**.
2. Type `cmd.exe` in the Open box. Click **OK**. Type the following command: `copy <path><filename> C:\Program Files\IBM\svconsole\cimom\icat.ppk` where `<path><filename>` is the path and file name where you stored the SSH private key when it was generated in the previous procedure.



**Note:** Directory names with embedded spaces must be surrounded by quotation marks.

3. A command prompt asks you if you want to overwrite the file in the C:\Program Files\IBM\svconconsole\cimom\icat.ppk directory. Type **Yes**.

For the change to take effect, the IBM CIM Object Manager must be stopped and restarted. Perform the following steps to stop and restart the IBM CIM Object Manager:

1. Click **Start -> Settings -> Control Panel**.
2. Double-click **Administrative Tools**.
3. Double-click **Services**.
4. Select **IBM CIM Object Manager** in the list of services, right click and select **Stop**. Wait for Windows to stop the service.
5. Select **IBM CIM Object Manager** in the list of services, right click and select **Start**.

**Related reference**

“Configuring the Secure Shell (SSH) client system” on page 80  
Ensure that you configure the Secure Shell (SSH) client system to set up your environment.

**Related information**

“Secure Shell (SSH)” on page 78  
Secure Shell (SSH) is a client-server network application.

## Maintaining SSH public keys

You can maintain secure shell (SSH) public keys on the cluster from the Maintain SSH Public Keys panel.

**Attention:** After you add a cluster, close the Maintaining SSH Keys panel.

SSH keys grant specific users administrator or service authority to run the command-line interface (command-line interface (CLI)) commands on the cluster.

Each key is associated with a user-defined ID string, which would typically be used to identify the key owner or location. The ID must meet the following requirements:

- The ID can be a maximum of 30 alphanumeric characters.
- Passwords are case-sensitive.
- Valid characters are uppercase letters [A through Z], lowercase letters [a through z], digits [0 through 9], dash [ - ], and underscore [ \_ ].
- The first character cannot be a dash [ - ].

Up to 100 keys can be stored on the cluster. You can add new IDs and keys or delete unwanted IDs and keys.

### Add keys

You can add a new key by first generating a valid SSH key on your workstation using an appropriate software utility. A key grants SSH access to the particular workstation on which it was generated. If access is required from multiple workstations, you need to add multiple keys. You can copy each key from the software utility and paste it into the **Public Key (direct input)** field. If the key is contained in a file on your workstation, you can specify the file location in the **Public Key (file upload)** field. Click **Browse** to locate the file on your workstation.

After you have specified the key, enter a new ID to be associated with this key, select the desired access level, and click **Add Key**.

### List keys

To view the IDs that have already been registered with the cluster, click **List keys**. A list of the registered IDs is displayed. You can delete one or more of the IDs by selecting them in the list and clicking **Delete selected IDs**. If you want to delete all the registered IDs, click **Delete all IDs**. The associated key is also deleted when the ID is deleted.

#### Related reference

“Configuring the Secure Shell (SSH) client system” on page 80

Ensure that you configure the Secure Shell (SSH) client system to set up your environment.

## Configuring the master console host name

If you have changed the host name of the master console, you must modify some of the IBM WebSphere Application Server files that are used by the SAN Volume Controller Console and Tivoli SAN Manager.

It is most likely that the host name is changed during the initial installation of the master console.

1. Click **Start** → **Settings** → **Control Panel**. The Control Panel window is displayed.
2. Click **Administrative Tools** → **Services**. The Services window is displayed.
3. Right-click **Tivoli Netview Service** and click **Start**.
4. Open the program C:\Support Utils\MCCconfig.exe. The Master Console Configuration window is displayed.
5. Ensure that the information in the three fields is accurate. The button next to the IP address field changes the IP addresses between the IP addresses of the different Local Area Connections. Click this button until the IP Address of Local Area Connection 2 is shown in the IP Address Field
6. Click **Configure**. A command-line window is displayed.
7. Ensure that there are no errors. If the command window displays the following:

```
BTACS0028E Command failed.
```

```
Press any key to continue . . .
```

- a. Open a command prompt window by clicking **Start** → **Run**, typing cmd.exe in the **Open** field, and then clicking **OK**.
  - b. Type the following three commands:

```
cd tivoli\itsanm\manager\bin\w32-ix86
setenv
srmcp -u userid -p xxxx ConfigService set SRMURL
http://<new full DNS name of the master console>:9530/ITSRM/TivoliSRM.html
```
  - c. Type **exit** to close the window. Any other errors should be reported to your IBM Support Representative.
8. Press any key to continue.
  9. Click **Exit**.
  10. Right-click **Tivoli Netview Service** and click **Stop**.

#### Related reference

“Master console” on page 73

The SAN Volume Controller provides a master console that can be used as a single platform to configure, manage, and service the SAN Volume Controller.

## Starting the Tivoli SAN Manager

Ensure that you configure the ITSANM to meet your requirements.

1. Double-click **Tivoli Netview** icon on your desktop.
2. You can limit the extent of the discovery to just the components attached to the SAN Volume Controller cluster. On the menu bar, select **Options -> Discovery** by editing the seed file to include the IP addresses of the fibre-channel switches and the master console.  
Refer to your Tivoli SAN Manager documentation for more information about discovery.
3. On the menu bar, select **SAN -> Configuration**. The Storage Area Network Manager Configuration window is displayed.
4. Click **Configure Manager**. The SAN Configuration window is displayed.
5. Click **Switches and Other SNMP Agents**.
6. Configure each fibre-channel switch to allow SNMP command access. Refer to your fibre-channel switch documentation for the procedure to set up this access.
7. Add the IP addresses of your fibre-channel switches into the SNMP Agents list.
  - a. In the SNMP Agent section of the SAN Configuration window, select each entry in turn and click **Advanced**.
  - b. Type the user ID and password for that particular switch to enable ITSANM to access the switch to collect zoning information.
8. Verify the installation by running a SAN discovery. Click **SAN Configuration**. This displays the SAN Configuration panel. Select **Clear History -> OK**.
9. Click **OK** to close the SAN Configuration window.
10. Click **Close** to close the Storage Area Network Manager Configuration window.

Ensure that ITSANM discovers all expected fibre-channel connections and devices. You can verify that ITSANM discovers all expected connections and devices by displaying the topology map for each fabric. To do this, click **Storage Area Network** from the Root window. Select the WWN of a SAN. Each SAN is represented by a white cloud icon. Click **Topology view**. Select your switches name. A representation of the devices that are attached to the switch is displayed. Ensure that no devices are missing. Repeat this procedure for each SAN.

**Note:** The correct names and icons will not display until the configuration is complete and you have installed a Tivoli SAN Manager Agent on at least one host.

Select each of the FC switches in turn and then on the menu bar select **SAN -->SAN Properties -->Connections**, and check that all the expected FC connections are present and correct per the configuration.

Click **SAN -> Configuration -> Configure Manager -> Set Event Destination** tab to enable you to set the SNMP Trap destination. This will probably be the IP address of the master console. Click **OK** when done. Click **Close** to close the Storage Area Network Manager Configuration window.

### Related reference

“Master console” on page 73

The SAN Volume Controller provides a master console that can be used as a single platform to configure, manage, and service the SAN Volume Controller.

## Setting up Remote Support

To set up Remote Support for the master console, complete these tasks.

### Related tasks

“Routing configuration”

If you do not know the IP address of your gateway for the master console you will need to perform the routing configuration.

“Downloading the virtual network computing (VNC) server” on page 87

Enhanced Remote Support enables support personnel to directly access the master console display and use the graphical tools provided on the master console.

### Related information

“Firewall configuration”

To configure the firewall, Local Area Connection 1 on the master console must be allowed to connect to connect to the IBM Remote Support Gateway via UDP port 500.

### Firewall configuration

To configure the firewall, Local Area Connection 1 on the master console must be allowed to connect to connect to the IBM Remote Support Gateway via UDP port 500.

If you have a NAT (network address translation) firewall, you will also need to allow Local area connection 1 on the master console to connect to the IBM Remote Support Gateway via UDP port 4500.

**Note:** For Remote Support to work, a maximum of two ports will need to be permitted to connect to the Local Area Connection 1 on the master console.

### Related tasks

“Setting up Remote Support”

To set up Remote Support for the master console, complete these tasks.

“Configuring the master console” on page 75

Ensure that you are familiar with the necessary steps to complete in order to configure the master console.

### Routing configuration

If you do not know the IP address of your gateway for the master console you will need to perform the routing configuration.

Perform the following steps if you don't know the IP address of the gateway of the master console:

1. Click **Start -> Programs -> Accessories -> Command Prompt** to open a command prompt window.
2. Type the **route print** command. At the bottom of the table the gateway is specified as the Default Gateway.

For every DNS server used by the master console a specific route must be configured. For every device, which is on a different subnet and that is to be

managed from the master console, a specific route must be configured. To do this, the IP addresses of these managed devices will be needed as well as the gateway for the master console.

**Note:** If these routes are not configured, when remote support is active, the master console will not be able to contact devices that are on a different subnet to the master console.

Perform the following steps to add the route for your DNS server:

1. Issue the following command: `route -p add <DNS Server IP Address (for Local Area Connection2)> MASK 255.255.255.255<IP Address of the gateway for the master console (for Local Area Connection2)>` where *<DNS Server IP Address (for Local Area Connection2)>* is the DNS server IP address and *<IP Address of the gateway for the master console (for Local Area Connection2)>* is the IP address of the gateway.
2. To add the routes for the other managed devices, issue the following command: `route -p add <IP Address of device to be managed> MASK 255.255.255.255 <IP Address of the gateway for the master console (for Local Area Connection2)>` where *<IP Address of device to be managed>* is the IP address of the device that you want to manage and *<IP Address of the gateway for the master console (for Local Area Connection2)>* is the IP address of the gateway.

#### **Related tasks**

“Setting up Remote Support” on page 86

To set up Remote Support for the master console, complete these tasks.

“Configuring a cluster using the SAN Volume Controller Console” on page 106

Once you’ve created a pair of nodes, you will then need to create and configure a cluster.

## **Downloading the virtual network computing (VNC) server**

Enhanced Remote Support enables support personnel to directly access the master console display and use the graphical tools provided on the master console.

To enable this enhanced Remote Support feature, you need to have the virtual network computing (VNC) installed on your master console.

Perform the following steps to download the VNC server:

1. Access the following Web site:  
<http://www.realvnc.com/download.html>

**Note:** If your master console can access the Internet, you can download the VNC application directly to master console. If your master console does not have access to the Internet, then you will need to download the files to another machine that does have Internet access and then transfer those files to the master console

2. Click **Windows 9x/2000/NT/XP (x86)**.
3. Click **x86 Win32**.
4. Download the file to the C:\Support Utils\VNC directory.
5. Double-click the executable file that you downloaded. Ensure that you fully install VNC by completing the installation wizard. The VNC server is set to run as a service and this service is *not* run automatically.
6. Click **Start -> Programs -> RealVNC -> Run VNC Server**.
7. Right-click the VNC system tray icon and select properties. Ensure that the following are selected:

- a. Accept Socket Connections
  - b. Auto
  - c. Poll Full Screen
  - d. Poll Foreground Window
  - e. Poll Window Under Cursor
8. Specify a password when requested to do so.

**Related tasks**

“Setting up Remote Support” on page 86

To set up Remote Support for the master console, complete these tasks.

## IBM Director

IBM Director is a systems-management solution that helps administrators manage single or large groups of IBM and non-IBM devices.

All of the functionality of IBM Director is contained in an IBM Director Console that enables single-click and drag-and-drop commands. IBM Director can manage up to 5 000 clients depending on configuration density. Powerful remote management functions include:

- Sophisticated discovery of network components, such as fibre-channel resources and IP resources.
- Scheduled asset (hardware and software) inventories with persistent storage of data
- Proactive problem notification and tools for problem resolution
- Hardware system component monitors and thresholds to trigger alerts of impending problems
- Alert management with automated actions, manual intervention, or both
- Process scheduling to automate wide-scale client software maintenance (clean up temporary files, restart tasks, backups, and so on) according to any timetable
- Help desk and routine maintenance functions such as remote control and file transfer
- Extensive security and authentication

Administrative tasks are performed at the console. It is a Java application that serves as the user interface to the Director-managed environment. The console provides comprehensive hardware management using a single click or drag-and-drop operation. You can install the console on a machine at a remote location from the server. In addition, there is no limit to the number of IBM Director consoles that can connect into the master console.

**Related tasks**

“Modifying your IBM Director settings”

Ensure that you modify your IBM Director settings to set up your master console environment.

### Modifying your IBM Director settings

Ensure that you modify your IBM Director settings to set up your master console environment.

Modify the following settings;

1. Open a command prompt window by clicking **Start -> Run**, typing `cmd.exe` in the **Open** field, and then clicking **OK**.
2. Type the following command:

c:\Program Files\ibm\Director\bin\twgipccf.exe

3. In the dialogue box displayed, change the System Name to the new name of the master console.
4. Click **OK**.
5. Change the Discovery settings.
  - a. Start IBM Director by clicking the IBM Director Console icon on the desktop.
  - b. In the IBM Director server field, enter the host name of your master console. In the user ID field, change the first part of the user ID to the unique name that you gave to your master console (for example, xxxxx\ADMINISTRATOR). Where xxxxx is the unique name of your master console.
  - c. Type the password password.
6. Close IBM Director.

#### **Related tasks**

“Configuring IBM Director for the SAN Volume Controller Call-Home and Event Notification”

Ensure that you configure IBM Director for the SAN Volume Controller error notification and Call-Home.

“Configuring the master console” on page 75

Ensure that you are familiar with the necessary steps to complete in order to configure the master console.

#### **Related reference**

“IBM Director” on page 88

IBM Director is a systems-management solution that helps administrators manage single or large groups of IBM and non-IBM devices.

## **Configuring IBM Director for the SAN Volume Controller Call-Home and Event Notification**

Ensure that you configure IBM Director for the SAN Volume Controller error notification and Call-Home.

SAN Volume Controller Call Home works as follows:

1. The SAN Volume Controller raises an SNMP trap as the result of a detected error.
2. The SAN Volume Controller sends its traps to a particular machine (for example, the master console) that has IBM Director installed.
3. IBM Director collects the traps and sends a specifically formatted e-mail to:
  - a. IBM Retain, which interrogates the e-mail and generates a Call Home request in the IBM Call Management System
  - b. A user-specified location (for example, the system administrator)

#### **Related tasks**

“Call-Home” on page 90

The Call Home configuration has already been partially completed during manufacture, but you need to input user-specific data to complete the Call Home e-mail.

“Event notification” on page 91

Event notification enables system administrators to receive e-mail notifications about problems with the SAN Volume Controller.

“Call-Home test” on page 92

After you have set up the call-home environment, ensure that you test the Call-home environment to make sure that the function works properly.

## Call-Home

The Call Home configuration has already been partially completed during manufacture, but you need to input user-specific data to complete the Call Home e-mail.

To set up this e-mail, perform the following steps:

1. Start IBM Director by clicking the IBM Director Console icon on the desktop.

**Note:** A pop-up window may appear, in which you will need to close the Event Action Plan window.

2. From the **IBM Director Console** menu bar, select **Tasks → Event Action Plan Builder**.
3. In the **Actions** column, expand the item **Send an Internet (SMTP) E-mail**.
4. Right-click **2145CallHome** and select **Update**. The **Customize Action: 2145CallHome** panel displays.
5. Fill in the following items:

### Internet E-mail Address

- Fill in the IBM Retain e-mail address:
  - a. CALLHOME1@de.ibm.com for customers in North America, Latin America, South America and Caribbean Islands
  - b. CALLHOME0@de.ibm.com for the customers in the rest of the world

### Reply to

- Fill in the e-mail address to which you want any replies to be directed.

### SMTP E-mail Server

- Fill in the address of your e-mail server.

### SMTP Port

- Change this, if required, to your SMTP server port number.

### Subject of E-mail Message

- Ensure that 2145 Event Notification is displayed.

### Body of the E-mail Message

- Fill in the following information:
  - Contact name
  - Contact phone number
  - Offshift phone number
  - Machine location

This information will replace the xxxx shown in the Body of E-mail message field.

**Note:** Ensure that you only replace the xxxxx and delete (Maximum 72 chars).

6. Click **File → Save** to save the information. The window will close.
7. Close the Event Action Plan Builder window.
8. Close the IBM Director Console window.

The following is an example of a completed body of the e-mail message:



```
# Contact name = John Doe
# Contact phone number = 546-247-1522
# Offshift phone number = 546-247-1733
# Machine location = Data Centre 1
# Record Type = 1
&iso.org.dod.internet.private.enterprises.ibm.ibmProd.190.4.1
&iso.org.dod.internet.private.enterprises.ibm.ibmProd.190.4.2
&iso.org.dod.internet.private.enterprises.ibm.ibmProd.190.4.3
&iso.org.dod.internet.private.enterprises.ibm.ibmProd.190.4.4
&iso.org.dod.internet.private.enterprises.ibm.ibmProd.190.4.5
&iso.org.dod.internet.private.enterprises.ibm.ibmProd.190.4.6
&iso.org.dod.internet.private.enterprises.ibm.ibmProd.190.4.7
&iso.org.dod.internet.private.enterprises.ibm.ibmProd.190.4.8
&iso.org.dod.internet.private.enterprises.ibm.ibmProd.190.4.9
&iso.org.dod.internet.private.enterprises.ibm.ibmProd.190.4.10
&iso.org.dod.internet.private.enterprises.ibm.ibmProd.190.4.11
&iso.org.dod.internet.private.enterprises.ibm.ibmProd.190.4.12
```

#### **Related tasks**

“Configuring IBM Director for the SAN Volume Controller Call-Home and Event Notification” on page 89

Ensure that you configure IBM Director for the SAN Volume Controller error notification and Call-Home.

#### **Event notification**

Event notification enables system administrators to receive e-mail notifications about problems with the SAN Volume Controller.

The Event notification configuration has already been partially completed during manufacture.

Perform the following steps to set up your e-mail notification:

1. Start IBM Director by clicking the IBM Director Console icon on the desktop.
2. From the IBM Director Console menu bar, select **Tasks** → **Event Action Plan Builder**.
3. In the **Actions** column, expand the item **Send an Internet (SMTP) E-mail**.
4. Right-click **2145EventNot** and select **Update**. The **Customize Action: 2145EventNot** panel displays.
5. Fill in the following items:

##### **Internet E-mail Address**

- Fill in an e-mail address (for example, the e-mail address of the system administrator)

##### **Reply to**

- Fill in the e-mail address to which you want any replies to be directed.

##### **SMTP E-mail Server**

- Fill in the address of your e-mail server.

##### **SMTP Port**

- Change this, if required, to your SMTP server port number.

##### **Subject of E-mail Message**

- Ensure that 2145 Event Notification is displayed in the Subject of E-mail message field.

##### **Body of the E-mail Message**

- Fill in the following information:
  - Machine location

This information will replace the xxxx shown in the Body of E-mail message field.

**Note:** Ensure that you only replace the xxxxx and delete (Maximum 72 chars).

6. Click **File -> Save** to save the information. The window will close.
7. Close the Event Action Plan Builder window.
8. Close the IBM Director Console window.

This has completed the IBM Director SAN Volume Controller Call-Home set up. Ensure that you verify that Call-Home has been configured correctly.

The following is an example of a completed body of the e-mail message:

```
# Contact name = John Doe
# Contact phone number = 546-247-1522
# Offshift phone number = 546-247-1733
# Machine location = Data Centre 1
# Record Type = 1
&iso.org.dod.internet.private.enterprises.ibm.ibmProd.190.4.1
&iso.org.dod.internet.private.enterprises.ibm.ibmProd.190.4.2
&iso.org.dod.internet.private.enterprises.ibm.ibmProd.190.4.3
&iso.org.dod.internet.private.enterprises.ibm.ibmProd.190.4.4
&iso.org.dod.internet.private.enterprises.ibm.ibmProd.190.4.5
&iso.org.dod.internet.private.enterprises.ibm.ibmProd.190.4.6
&iso.org.dod.internet.private.enterprises.ibm.ibmProd.190.4.7
&iso.org.dod.internet.private.enterprises.ibm.ibmProd.190.4.8
&iso.org.dod.internet.private.enterprises.ibm.ibmProd.190.4.9
&iso.org.dod.internet.private.enterprises.ibm.ibmProd.190.4.10
&iso.org.dod.internet.private.enterprises.ibm.ibmProd.190.4.11
&iso.org.dod.internet.private.enterprises.ibm.ibmProd.190.4.12
```

#### **Related tasks**

“Configuring IBM Director for the SAN Volume Controller Call-Home and Event Notification” on page 89

Ensure that you configure IBM Director for the SAN Volume Controller error notification and Call-Home.

“Configuring the master console” on page 75

Ensure that you are familiar with the necessary steps to complete in order to configure the master console.

#### **Call-Home test**

After you have set up the call-home environment, ensure that you test the Call-home environment to make sure that the function works properly.

Perform the following steps to test Call-Home:

1. Start IBM Director by clicking the IBM Director Console icon on the desktop.
2. From the IBM Director Console menu bar, select **Tasks ->Event Action Plan Builder**.
3. In the **Actions** column, expand the item **Send an Internet (SMTP) E-mail**.
4. Right-click **2145Test** and select **Update**. The **Customize Action: 2145Test** panel displays.

5. Fill in the following items:

**Internet E-mail Address**

- Fill in the IBM Retain e-mail address:
  - a. CALLHOME1@de.ibm.com for customers in the USA and Canada
  - b. CALLHOME0@de.ibm.com for the customers in the rest of the world

**Reply to**

- Fill in the e-mail address to which you want any replies to be directed.

**SMTP E-mail Server**

- Fill in the address of your e-mail server.

**SMTP Port**

- Change this, if required, to your SMTP server port number.

**Subject of E-mail Message**

- Ensure that 2145 Call Home Test is displayed in the Subject of E-mail message field.

**Body of the E-mail Message**

- Fill in the following information:
  - Contact name
  - Contact phone number
  - Offshift phone number
  - Machine location
  - Serial number

**Note:** When filling out the serial number, ensure that you replace the entire string, in other words delete [Serial Number] and replace it with the serial number of any SAN Volume Controller node. The SAN Volume Controller node's serial number can be located on the label to the right of the front panel.

This information will replace the xxxx shown in the Body of E-mail message field with the exception of the serial number.

**Note:** Ensure that you only replace the xxxxx and delete (Maximum 72 chars).

6. Click **File -> Save** to save the information. The window will close.
7. Right-click **2145Test** and select **Test**. This will generate a Call-Home record. You will receive a phone call from an IBM representative within 24 hours to confirm that the Call-Home test has been successful. If you do not receive a phone call, you should report this as a Call-Home failure.
8. Close the Event Action Plan Builder window.
9. Close the IBM Director Console window.

The following is an example of a completed body of the e-mail message:

```
# Contact Name = John Doe
# Contact phone number = 546-247-1522
# Offshift phone number = 546-247-1522
# Machine location = Data Centre 1
# Record Type = 4
# Machine Type/Model = 21454F2
# Serial Number = 5538r43
```

### Related tasks

“Configuring IBM Director for the SAN Volume Controller Call-Home and Event Notification” on page 89

Ensure that you configure IBM Director for the SAN Volume Controller error notification and Call-Home.

## Upgrading software on the master console

The software on the master console may need to be upgraded from time to time.

### Vendor software

Table 13 provides information about upgrading your vendor software.

Table 13. Upgrading vendor software

Software	Reasons to upgrade
Microsoft Windows 2000 Server Edition and Service Pack	Requires an upgrade only if new functions are required.
Windows 2000 Security Patches	Critical updates should be installed as they become available in order to avoid security exposures. Visit the Web site: <a href="http://windowsupdate.microsoft.com">http://windowsupdate.microsoft.com</a>
Host Bus Adapter driver	Requires an upgrade only if a problem is found or a new function is required.
PuTTY	Required an upgrade only if a problem is found or a new function is required.
Adobe Acrobat Reader	Requires an upgrade only if a problem is found or a new function is required.

### IBM software

Table 14 provides information about upgrading your IBM software.

Table 14. Reasons to upgrade IBM software

Software	Reasons to upgrade
IBM Director	Requires an upgrade only if a problem is found or a new function is required.
SAN Volume Controller Console	Requires an upgrade only if a problem is found or a new function is required.
IBM FAStT Storage Manager	Requires an upgrade only if a problem is found or a new function is required.
Connection Manager	Requires an upgrade only if a problem is found or a new function is required.
Tivoli SAN Manager	Requires an upgrade only if a problem is found or a new function is required.

All the software packages are provided on CDs with the master console installation instructions for the software packages are located in the individual software installation guides.

It is the user's responsibility to download and install software upgrades for the master console. For recommended IBM upgrades, see the following Web site:

<http://www-1.ibm.com/servers/storage/support/virtual/2145.html>

#### **Related reference**

“Master console” on page 73

The SAN Volume Controller provides a master console that can be used as a single platform to configure, manage, and service the SAN Volume Controller.

## **Connecting to the Remote Support Center**

You can connect the master console to the Remote Support Center.

To ensure that the support engineer has the correct access to the master console and its various software packages, it might be necessary to provide passwords to the service representative, including the administrator password. Alternatively, you might elect to physically type the passwords yourself when required.

When IBM is trying to provide a solution to a particular problem, you might be requested to invoke or make a remote support connection so that a remote service representative can interrogate the master console to collect additional information on the problem.

Perform the following steps to set up a secure connection to IBM with Connection Manager:

1. Double-click the IBM Connection Manager icon on the desktop. The Connection Manager panel is displayed.
2. Select an IBM support destination from the list.  
If a new destination is required, information will be provided by the remote support engineer.
3. Click **Make Connection** when you are ready for the IBM remote service representative to log in. The status *Disconnected* at the bottom of the panel changes to *Connected*.
4. Click **Generate Connection ID**. An alphanumeric string displays in the box to the right of the **Generate Connection ID** button. This is your connection ID. You must provide this to the IBM remote service representative.
5. Click **Disconnect** to terminate the connection after the remote support actions are complete. The status *Connected* at the bottom of the panel changes back to *Disconnected*.
6. Click **OK** on the panel that displays.
7. Click **Cancel**, and then click **OK**.

#### **Related reference**

“Master console” on page 73

The SAN Volume Controller provides a master console that can be used as a single platform to configure, manage, and service the SAN Volume Controller.

## **Clearing the Windows™ event logs**

Configuring the master console might cause a number of log entries in the Windows event logs.

You should clear all three logs to ensure that these do not cause confusion when trying to isolate problems.

The following procedure assumes that your Windows desktop is displayed.

1. Right-click **My Computer** and select **Manage**.

2. Expand **Event Viewer**.
3. Right-click **Application** and select **Clear All Events**. Click **No** on the panel that asks you if you want to save the log before clearing.
4. Right-click **Security** and select **Clear All Events**. Click **No** on the panel that asks you if you want to save the log before clearing.
5. Right-click **System** and select **Clear All Events**. Click **No** on the panel that asks you if you want to save the log before clearing.

All of the log entries are cleared.

#### **Related reference**

“Master console” on page 73

The SAN Volume Controller provides a master console that can be used as a single platform to configure, manage, and service the SAN Volume Controller.

## **Troubleshooting master console problems**

If you experience problems with the master console, ensure that you perform the appropriate troubleshooting procedures.

- Ensuring that ITSANM Netview information is not lost
- Recovering from Voltage sensor error message
- Connecting to the Remote Support Center
- Recovering from SAN Volume Controller Console signing off
- Resolving Windows 2000 boot problem

#### **Related information**

“Ensuring that ITSANM Netview information is not lost”

Ensure that the ITSANM Netview information is not lost during the configuration.

“Recovering from a voltage-sensor error message” on page 97

Under certain conditions, the IBM Director and master console interact in such a way that error messages are displayed which should be ignored.

“Recovering from SAN Volume Controller Console signing off” on page 97

Ensure that you perform the appropriate troubleshooting procedures to recover from SAN Volume Controller Console signing off.

“Resolving Windows 2000 boot problem” on page 98

Ensure that you perform the appropriate troubleshooting procedures when resolving Windows 2000 boot problems.

### **Ensuring that ITSANM Netview information is not lost**

Ensure that the ITSANM Netview information is not lost during the configuration.

#### **Problem**

Tivoli Netview displays all resources as red. These resources are either offline or they cannot be contacted.

#### **Investigation**

##### **If all the resources are red**

- Ensure that Port 2 is connected to the public network, that is, the rest of your LAN that includes the SAN Volume Controllers, the disk controller systems, and the SAN switches
- Port 1 is for connection to the Internet (through your firewall DMZ or equivalent) and is used for remote support

#### **Related information**

“Troubleshooting master console problems” on page 96

If you experience problems with the master console, ensure that you perform the appropriate troubleshooting procedures.

### **Recovering from a voltage-sensor error message**

Under certain conditions, the IBM Director and master console interact in such a way that error messages are displayed which should be ignored.

#### **Problem**

You see an indication-notification error message and entries in the Windows™ event logs that indicate that a voltage sensor has detected a condition that is outside its threshold. For example, a message similar to the following might be displayed:

Voltage Sensor 1 fell below threshold of 3.42 Volts.  
The current value is 0.50 Volts

**If you see a message similar to this, the message is not valid. It should be ignored.**

Click **OK** when the error message is displayed.

#### **Related information**

“Troubleshooting master console problems” on page 96

If you experience problems with the master console, ensure that you perform the appropriate troubleshooting procedures.

### **Recovering from SAN Volume Controller Console signing off**

Ensure that you perform the appropriate troubleshooting procedures to recover from SAN Volume Controller Console signing off.

#### **Problem**

You are presented with a dialogue box containing the words: You have signed off. This window will be closed. Before checking for hardware errors, open a new browser window and try to reconnect to the SAN Volume Controller Console. The sign off message is generally caused by the open browser session timing out. If you have left the browser window open from a previous session, this is the likely cause. You should be able to reconnect. If you cannot reconnect, perform the following steps.

Try the following actions to resolve the problem:

#### **Investigation**

**The problem could be due to:**

- **A memory failure in the master console and it is running with less than the required one gigabyte of memory.**

Check and correct the memory problem.

- 

**The IP address of the master console changing since the last reboot.**

Restart the master console to correct this problem.

#### **Related information**

“Troubleshooting master console problems” on page 96

If you experience problems with the master console, ensure that you perform the appropriate troubleshooting procedures.

## Resolving Windows 2000 boot problem

Ensure that you perform the appropriate troubleshooting procedures when resolving Windows 2000 boot problems.

### Problem

During the Windows boot process, Windows tries to start but fails. A blue screen is displayed with the message `Inaccessible Boot Device` and another reboot does not solve the problem.

### Investigation

#### The Windows boot code is corrupted on the Startup Device

Use the following procedure to try to resolve the problem:

1. Re-start the machine
2. When prompted, Press **F1** (F1 for Configuration/Setup)
3. Select **Start Options**
4. Select **Start Sequence**
5. Step down to sequence to the one that contains the Hard Disk
6. Using the left or right cursor keys select the other hard disk. (If it is set to 1 then select **0** if it is set to 0 then select **1**)
7. Press **Esc** to exit.
8. Select **Yes** to exit

#### The machine should now boot up

Perform the following procedure to recover the failing hard disk

- Right-click **My Computer** on the desktop and select **Manage**.
- Select **Disk Management**. The hard drives display in the right panel.
- Right-click on the failing disk, the other one to the one that you selected to boot from in the previous procedure
- Select **Reactivate Disk**, this will cause the disk mirroring to be re-started.

The status of both volumes will change to `Regenerating` and will, after a short period of time, start to show the percentage of regeneration completed. When the regeneration completes, the status should show as `Healthy`.

#### Related information

“Troubleshooting master console problems” on page 96

If you experience problems with the master console, ensure that you perform the appropriate troubleshooting procedures.

## Installing antivirus software

In order to protect your workstations and your enterprise, install the latest patches for your Windows operating system and the latest levels of your antivirus software on the master console.

If the master console is either connected to your local area network or you have enabled remote support, you must install the latest levels of the antivirus software that your enterprise uses.

#### Related reference



“Master console” on page 73

The SAN Volume Controller provides a master console that can be used as a single platform to configure, manage, and service the SAN Volume Controller.



---

## Chapter 3. SAN Volume Controller Console

Ensure that you perform the following appropriate procedures on the SAN Volume Controller.

### Related reference

“Overview of creating a cluster using the SAN Volume Controller Console” on page 105

The create cluster wizard of the SAN Volume Controller Console enables you to create a cluster.

“Advanced function FlashCopy overview” on page 134

Ensure that you are familiar with the FlashCopy advanced functions.

### Related information

“Using the SAN Volume Controller Console”

The SAN Volume Controller is provided with a console that is Web-browser based. It is known as the SAN Volume Controller Console.

“Scenario: typical usage for the SAN Volume Controller Console” on page 118

This hypothetical example describes a scenario for configuring the SAN Volume Controller using the SAN Volume Controller Console.

“Advanced functions overview for the SAN Volume Controller Console” on page 137

You can perform “advanced” functions using the SAN Volume Controller Console.

---

## Using the SAN Volume Controller Console

The SAN Volume Controller is provided with a console that is Web-browser based. It is known as the SAN Volume Controller Console.

### Overview

The SAN Volume Controller Console can be used to create and maintain the configuration of storage associated with the SAN Volume Controller. It also provides user management and access to multiple clusters.

The functions that can be performed with the SAN Volume Controller Console:

- Initial setup of the cluster, its nodes, and the I/O groups (or node pairs). This function includes diagnostics and error log analysis of the cluster.
- Setup and maintenance of managed disks and managed disk groups.
- Setup and maintenance of SSH keys.
- Setup and maintenance of virtual disks.
- Setup of logical host objects.
- Mapping of virtual disks to hosts.
- Navigation from managed hosts to virtual disk and to managed disk groups, and the reverse direction up the chain.
- Set up and start of Copy Services:
  - FlashCopy and FlashCopy Consistency groups
  - Synchronous Remote Copy and Remote Copy Consistency groups

The SAN Volume Controller Console is Storage Management Initiative Specification (SMI-S) compliant.

### **Related reference**

“Accessing the SAN Volume Controller Console”

You access the SAN Volume Controller Console by pointing a Web browser at a URL.

“SAN Volume Controller Console layout” on page 103

Ensure that you are familiar with the basic frame layout of the SAN Volume Controller Console.

“SAN Volume Controller Console banner area” on page 103

The banner area of the SAN Volume Controller Console is used for product or customer identification.

“SAN Volume Controller Console task bar” on page 104

The task bar of the SAN Volume Controller Console keeps track of all opened primary tasks and allows you to quickly go back to the previous task or move forward to the next task.

“SAN Volume Controller Console portfolio” on page 104

The portfolio area of the SAN Volume Controller Console contains task-based links that open panels in the work area.

“SAN Volume Controller Console work area” on page 104

The work area of the SAN Volume Controller Console is where you work with a cluster and the objects it contains.

### **Related information**

“Upgrading the SAN Volume Controller Console software” on page 104

Before upgrading the software for the SAN Volume Controller Console, perform the steps outlined in the procedure called “Configuring the master console host name.”

## **Accessing the SAN Volume Controller Console**

You access the SAN Volume Controller Console by pointing a Web browser at a URL.

The SAN Volume Controller Console is a Web-based application that you can use to manage multiple clusters. Because the application is Web-based, do not set the browser to disable popup windows. This can prevent the windows in the SAN Volume Controller Console from opening.

You access the SAN Volume Controller Console by pointing a Web browser at the following URL on your master console:

```
http://<svccconsoleip>:9080/ica
```

where *<svccconsoleip>* is the IP address of your master console.

Log on to the SAN Volume Controller Console using the superuser user name, which is superuser, and the superuser password, which is passw0rd. (Upon first access, you will be required to change the superuser password.)

Use the SAN Volume Controller Console panels to configure SAN Volume Controller clusters in your environment. Once the cluster has been configured, you can use the View Clusters panel to launch another browser window with specific information for a specific cluster.

### **Related information**

“Using the SAN Volume Controller Console” on page 101  
The SAN Volume Controller is provided with a console that is Web-browser based. It is known as the SAN Volume Controller Console.

## SAN Volume Controller Console layout

Ensure that you are familiar with the basic frame layout of the SAN Volume Controller Console.

Figure 22 provides, the basic frame layout, which consists of a banner, task bar, portfolio and a work area. An optional frame can be added for embedded task assistance or help.

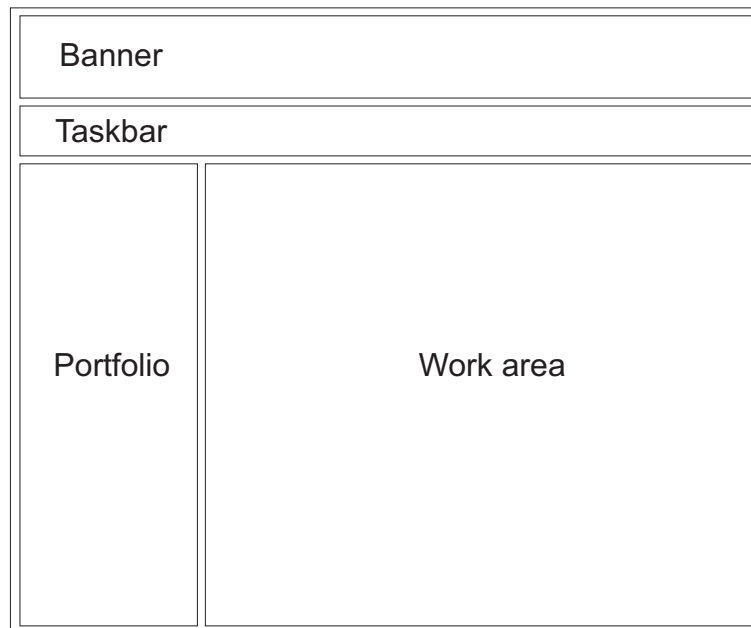

Figure 22. Basic frame layout

### Related information

“Using the SAN Volume Controller Console” on page 101  
The SAN Volume Controller is provided with a console that is Web-browser based. It is known as the SAN Volume Controller Console.

## SAN Volume Controller Console banner area

The banner area of the SAN Volume Controller Console is used for product or customer identification.



Figure 23. Banner area

### Related information

“Using the SAN Volume Controller Console” on page 101  
The SAN Volume Controller is provided with a console that is Web-browser based. It is known as the SAN Volume Controller Console.

## SAN Volume Controller Console task bar

The task bar of the SAN Volume Controller Console keeps track of all opened primary tasks and allows you to quickly go back to the previous task or move forward to the next task.

Clicking the **question mark (?)** icon on the right side brings up the information center in a separate browser window; clicking the (I) icon brings up a help topic for the panel that is currently displayed in the work area.



Figure 24. Task bar

### Related information

“Using the SAN Volume Controller Console” on page 101

The SAN Volume Controller is provided with a console that is Web-browser based. It is known as the SAN Volume Controller Console.

## SAN Volume Controller Console portfolio

The portfolio area of the SAN Volume Controller Console contains task-based links that open panels in the work area.

Common tasks are grouped under task headings and are expandable and collapsible.

### Related information

“Using the SAN Volume Controller Console” on page 101

The SAN Volume Controller is provided with a console that is Web-browser based. It is known as the SAN Volume Controller Console.

## SAN Volume Controller Console work area

The work area of the SAN Volume Controller Console is where you work with a cluster and the objects it contains.

The work area is the main area of the application.

### Related information

“Using the SAN Volume Controller Console” on page 101

The SAN Volume Controller is provided with a console that is Web-browser based. It is known as the SAN Volume Controller Console.

## Upgrading the SAN Volume Controller Console software

Before upgrading the software for the SAN Volume Controller Console, perform the steps outlined in the procedure called “Configuring the master console host name.”

### Related tasks

“Configuring the master console host name” on page 84

If you have changed the host name of the master console, you must modify some of the IBM WebSphere Application Server files that are used by the SAN Volume Controller Console and Tivoli SAN Manager.

### Related information

“Using the SAN Volume Controller Console” on page 101  
The SAN Volume Controller is provided with a console that is Web-browser based. It is known as the SAN Volume Controller Console.

---

## Overview of creating a cluster using the SAN Volume Controller Console

The create cluster wizard of the SAN Volume Controller Console enables you to create a cluster.

### Related concepts

“Browser requirements for the SAN Volume Controller”

Ensure that you are familiar with the Internet browsers and settings when using the SAN Volume Controller.

### Related tasks

“Configuring a cluster using the SAN Volume Controller Console” on page 106

Once you’ve created a pair of nodes, you will then need to create and configure a cluster.

“Launching the SAN Volume Controller Console” on page 114

You can launch the SAN Volume Controller from the Viewing Clusters panel.

“Setting cluster time” on page 116

You can set the cluster time for the SAN Volume Controller from the Setting Cluster Time panel.

“Displaying cluster properties using the SAN Volume Controller Console” on page 117

You can display cluster properties from the View Cluster properties panel.

## Browser requirements for the SAN Volume Controller

Ensure that you are familiar with the Internet browsers and settings when using the SAN Volume Controller.

The following Web browser versions are required.

- Windows and UNIX operating systems
  - Netscape version 6.2
    - Netscape is available from the following Web site:  
  
<http://wp.netscape.com/download/archive.html>
  - Internet Explorer Version 6 or later
    - You can get version 6 or later from the following Web site:  
  
<http://www.microsoft.com/windows/ie/downloads/ie6/default.asp>
- AIX operating system
  - You can get AIX Netscape version 7.0 from the following Web site:  
  
<http://devedge.netscape.com/central/gecko/2002/download/>

You must ensure that the proxy setting is disabled.

- For Netscape, perform the following steps:
  1. Open your Netscape browser and click **Edit -> Preferences**. The Preferences window is displayed.
  2. From the left side category, click **Advanced** to expand the sub options. The sub option Proxies is displayed.

3. Click **Proxies**. The Proxies window is displayed.
  4. Select **Direct connection to Internet**.
- For Internet Explorer, perform the following steps:
1. Click **Tools -> Internet Options -> Connections -> LAN Settings**.
  2. Click to clear the **Use a proxy server** box.

#### **Related reference**

“Overview of creating a cluster using the SAN Volume Controller Console” on page 105

The create cluster wizard of the SAN Volume Controller Console enables you to create a cluster.

## **Configuring a cluster using the SAN Volume Controller Console**

Once you’ve created a pair of nodes, you will then need to create and configure a cluster.

If you are creating a cluster using the SAN Volume Controller, you will need to generate a SSH key pair before performing this task. If you are adding an SSH public key to enable your system to use the command-line interface (CLI), you will need to have generated an SSH key pair for this system.

Perform the following steps to create a cluster on the SAN Volume Controller Console:

1. Create a cluster from the front panel of the SAN Volume Controller. A temporary password for the administrator use is generated by the node.
2. Access the SAN Volume Controller Console using a Web browser.
3. Sign on with the superuser name and password. For first-time access, use the superuser name `superuser` and the default password `passwd`. You must change this default password the first time you sign on. After you sign on with the superuser name and password, the Welcome panel is displayed.
4. Add a new cluster to the SAN Volume Controller.
5. Complete the Creating a Cluster wizard:
  - a. Complete the creation of the cluster
  - b. Set up the error notification settings
  - c. Set up the featurization attributes
  - d. Upload the SSH key
6. Type the IP address of the cluster and select the **Create (Initialize) Cluster** check box. When you click **OK**, the Create a Cluster wizard opens.
7. The Creating a Cluster wizard presents panels to complete the following steps:
  - a. Create new cluster information, such as:
    - The new admin password
    - The service password
    - The name of the cluster
    - A service IP address
  - b. Set up the error logging attributes.
  - c. Set up the featurization attributes.
  - d. Upload the SSH key through the wizard.

Once these steps are complete and you have exited out of the wizard, you can now use the Web application for the SAN Volume Controller passwords.



Perform the following steps to create a cluster using the Create a Cluster wizard:

1. Start the SAN Volume Controller Console by clicking on the desktop icon or by pointing your Web browser to `http://<svccconsoleip>:9080/ica`, where `<svccconsoleip>` is the IP address of the master console.
2. The Enter Network Password window is displayed. Type `superuser` for the user ID and `passwd` for the password. The first time you sign on as the superuser, you must change the password for the superuser. After you change the password, the Welcome panel is displayed.
3. If this is the first time you have accessed the SAN Volume Controller Console, go to step 3a. Otherwise, go to step 3b.
  - a. The Welcome panel is shown as in Figure 26 on page 108. Click the **Add SAN Volume Controller Cluster** button.

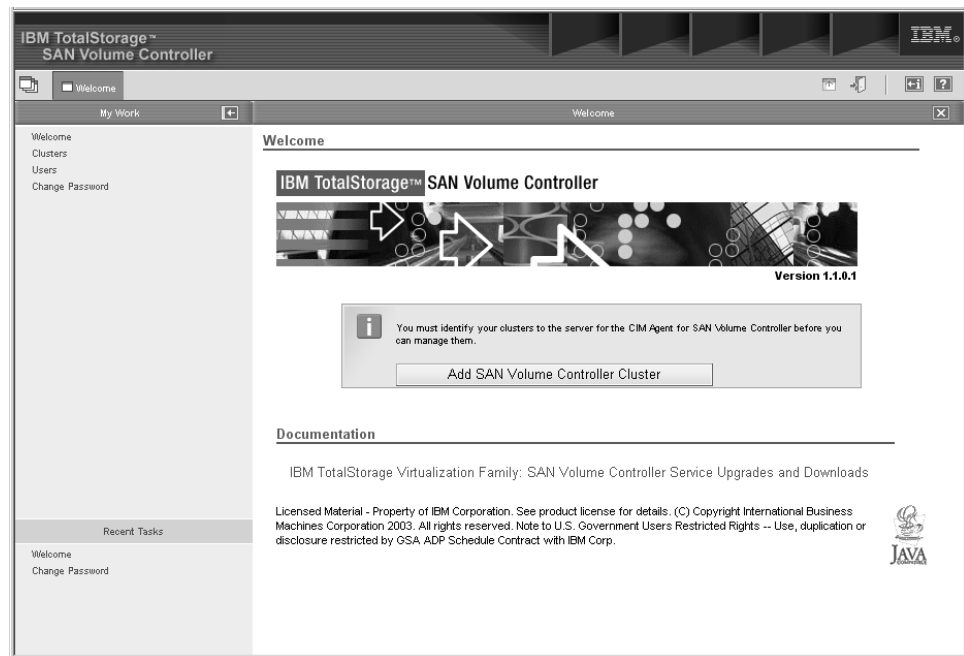

Figure 25. Welcome panel

- b. Select **Clusters** from the portfolio. From the list of tasks, select **Add cluster** and click **Go**.

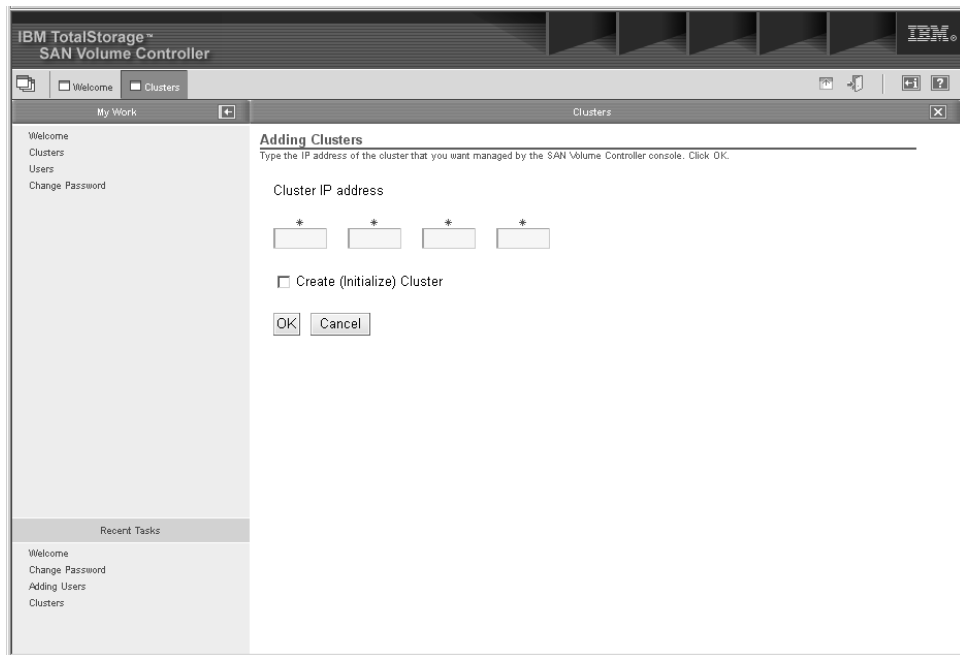

Figure 26. Add Cluster panel

4. Click **Create new cluster**. The SAN Volume Controller creates the new cluster. When the new administrator password is accepted, the cluster displays the password prompt again.
5. Type the user IDadmin and the new administrator password.
6. Select **Add a Cluster** from the menu, then click **Go** .
7. Enter the IP address of your cluster.

If the cluster has not been fully created (that is, you have just followed the steps in chapter 5 and created the cluster from the front panel), select the **Create (Initialize) Cluster** check box.

If the cluster is already in use and you are just adding this cluster to the clusters that this installation of the SAN Volume Controller Console is managing, do not select the Create (Initialize) Cluster check box. Click **OK**.

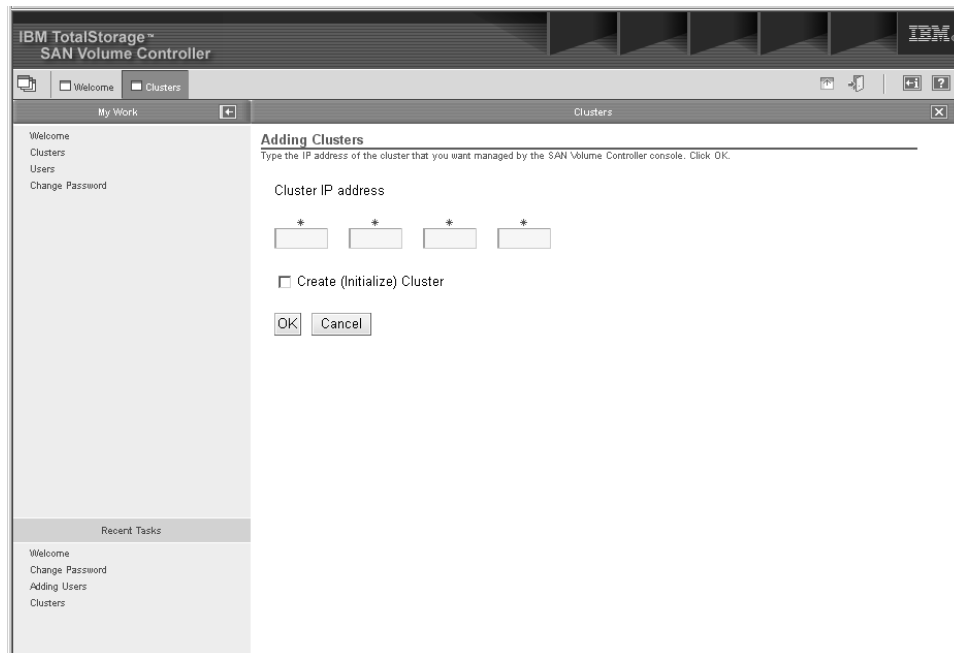

Figure 27. Add Cluster panel

8. You will be prompted to accept the new certificate for the cluster.

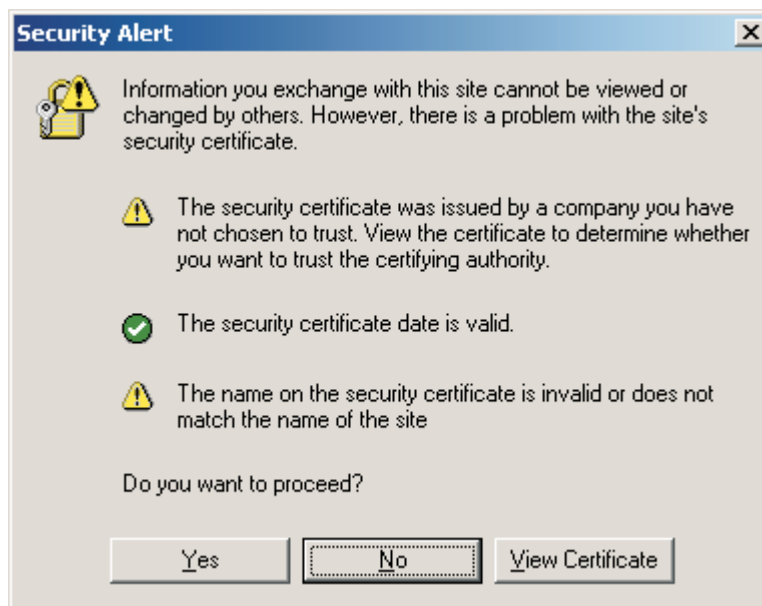

Figure 28. Security alert panel

Click **View Certificate** and on the resulting window click **Install Certificate**.



Figure 29. Certificate Information panel

Click **Next**, **Next**, **Install**, **OK** to complete the install certificate window.

Click **OK** to close the Certificate window as shown in Figure 28 on page 109 and click **Yes** to close the Security Alert window as shown in Figure 29.

9. You will be prompted for the cluster user name and password. The username is `admin` and the password is the one generated by the process described in the topic about Creating a cluster from the front panel. Enter the random password that was generated and click **OK**.
10. The Create a Cluster wizard begins, click **Continue**. If the cluster already existed and you did not check the **Initialize Cluster** checkbox in step 7 on page 108 proceed to step 14 on page 113.
11. Complete the Create New Cluster step by entering a new administrator password and enter a service password. Note these passwords as you will need them in the future to upload new SSH keys via the SAN Volume Controller Console.

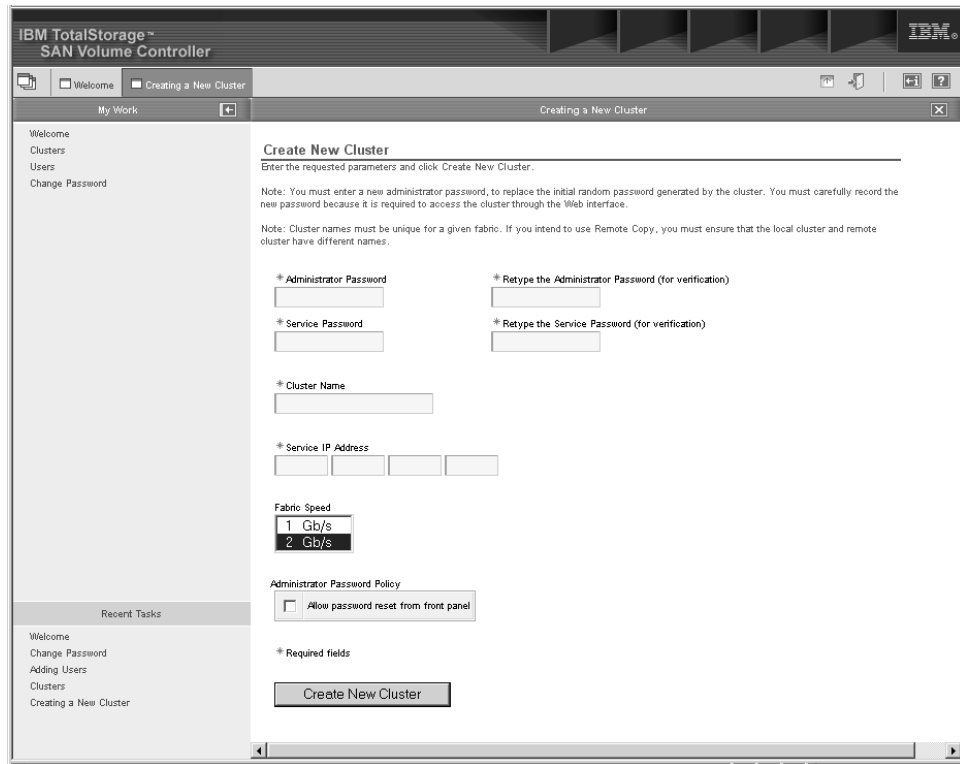

Figure 30. Create New Cluster wizard

- a. Enter a name for you cluster. You can modify the cluster name by issuing the following command:
 

```
svctask chcluster -name <cluster_name>
```
  - b. Enter the service IP address for the cluster, this is the IP address that will be used if you have to bring a single node up in service mode.
  - c. Select the speed of your fabric, either 1 or 2 Gb/s
  - d. If you wish to be able to reset the administrator password from the front panel then check the box.
  - e. When complete click the Create New Cluster button. The cluster will then be created; this will take a few seconds. When the web page returns, click **Continue**.
12. You will then be notified that the password has been changed. Click **Continue** to proceed to the **Error Notification Settings** panel.

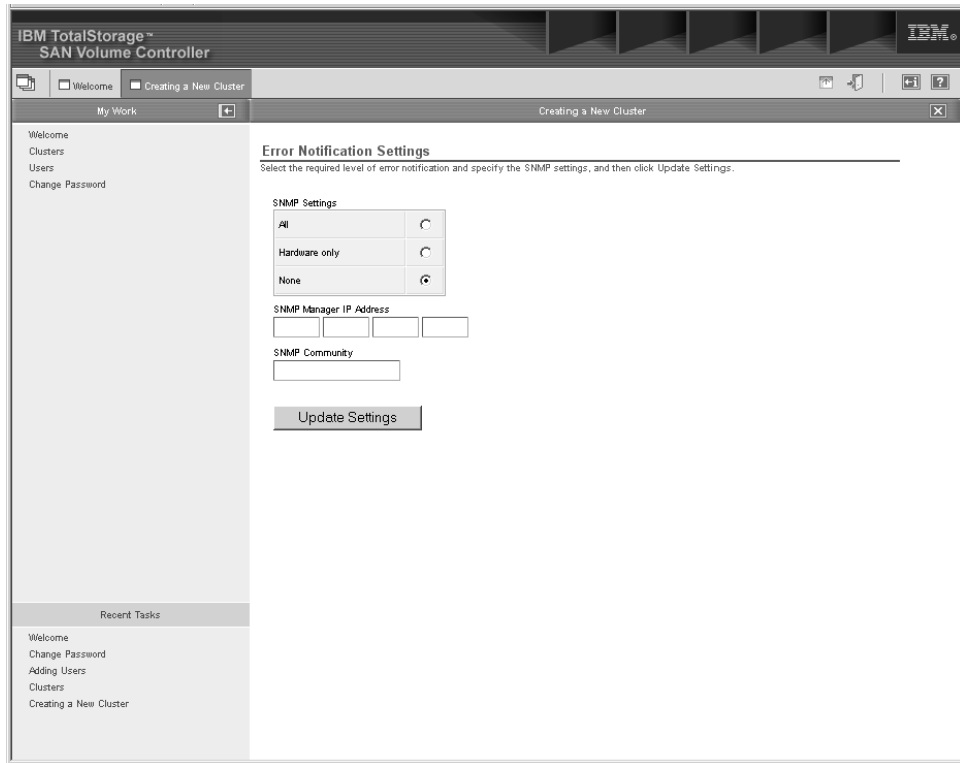

Figure 31. Error Notification Settings panel

- a. If you wish errors to be forwarded as SNMP traps, select either **All** or **Hardware only**. Hardware only sends SNMP traps for hardware-related errors, All sends SNMP traps for all errors, hardware and software.
  - b. Enter the IP address of the machine that is running your SNMP management software (note if you are using IBM Director on the master console to collect SNMP traps, enter the IP address of the master console here)
  - c. Enter the SNMP community name.
  - d. Click **Update Settings** to continue.
13. Click **Continue**. The Featurization window is displayed.

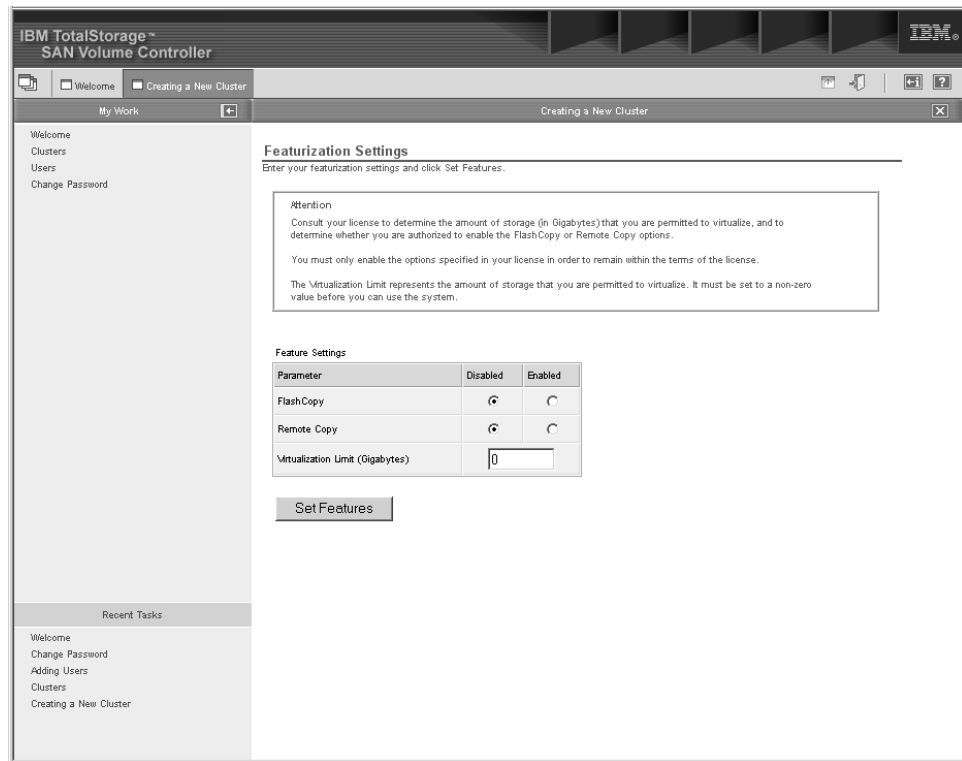

Figure 32. Featurization Settings panel

The allowed setting for each of the parameters is specified in your user's license.

- a. Enable the FlashCopy or Remote copy options if they are licensed.
  - b. Enter the virtualization limit as specified in the licence. A zero value is not allowed for this field.
  - c. Click **Set features**. A featurization screen is displayed.
14. Click **Continue** to display the Add SSH Public Key step.  
At this point you may be re-prompted for a username and password. Enter admin as the user name and enter the new password you gave during 11 on page 110.

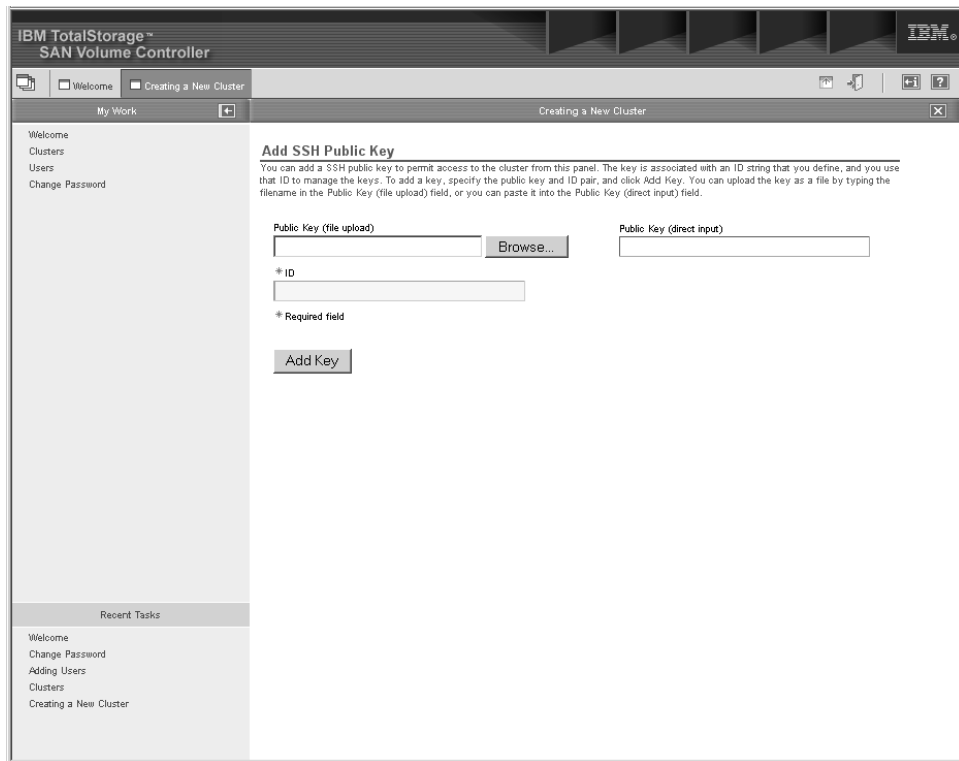

Figure 33. Add SSH public key panel

Click Browse to locate the public key for the master console.

Enter an ID (label) for this key and click **Add Key**.

15. Click on the X in the corner of the window to close the wizard.

You have now successfully connected and configured the cluster.

The cluster is created and it should be listed on the Viewing Clusters panel.

**Note:** You may have to press **Refresh** on the Viewing Clusters panel to see the new cluster.

#### **Related tasks**

“Create cluster from the front panel” on page 69

After you have created a pair of nodes, you can now create a cluster from the front panel.

#### **Related reference**

“Overview of creating a cluster using the SAN Volume Controller Console” on page 105

The create cluster wizard of the SAN Volume Controller Console enables you to create a cluster.

#### **Related information**

“Scenario: typical usage for the SAN Volume Controller Console” on page 118

This hypothetical example describes a scenario for configuring the SAN Volume Controller using the SAN Volume Controller Console.

## **Launching the SAN Volume Controller Console**

You can launch the SAN Volume Controller from the Viewing Clusters panel.



The SAN Volume Controller is the centralized Web application that is used to manage your clusters. It is preinstalled on the Master console.

This procedure assumes that you are at the Welcome panel for the SAN Volume Controller.

Perform the following steps to launch the SAN Volume Controller:

1. Click **Clusters** from the portfolio. The Viewing Clusters panel is displayed.
2. Select the cluster that you want to manage with the application.
3. Select **Launch the SAN Volume Controller application** from the drop-down list and click **Go**. A secondary browser window opens.

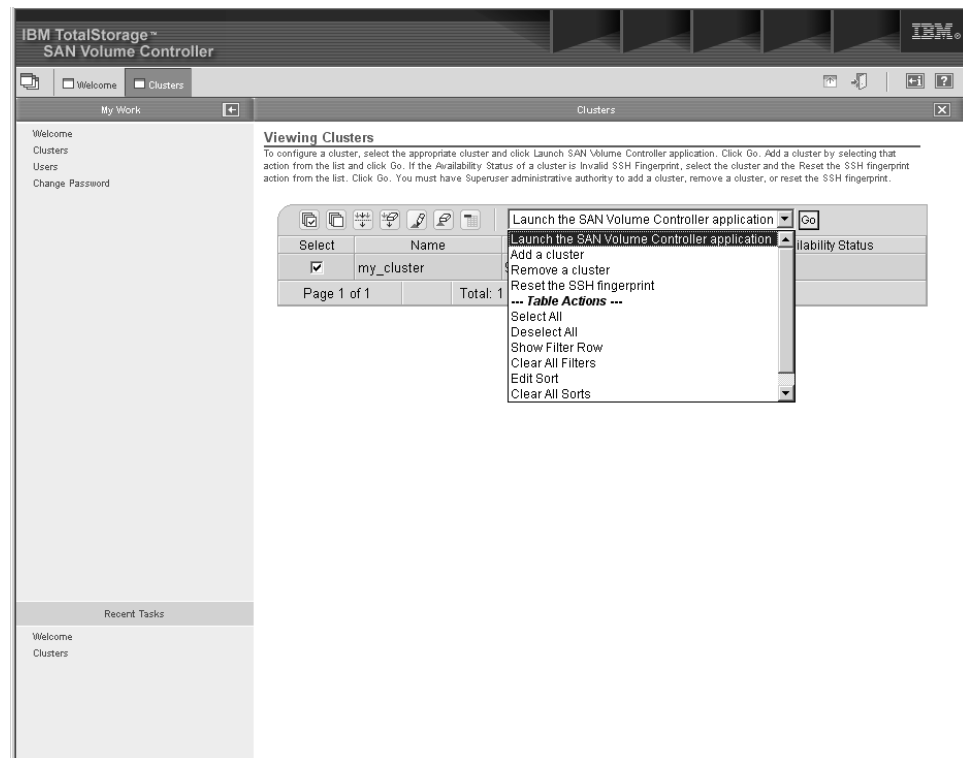

Figure 34. Viewing clusters panels

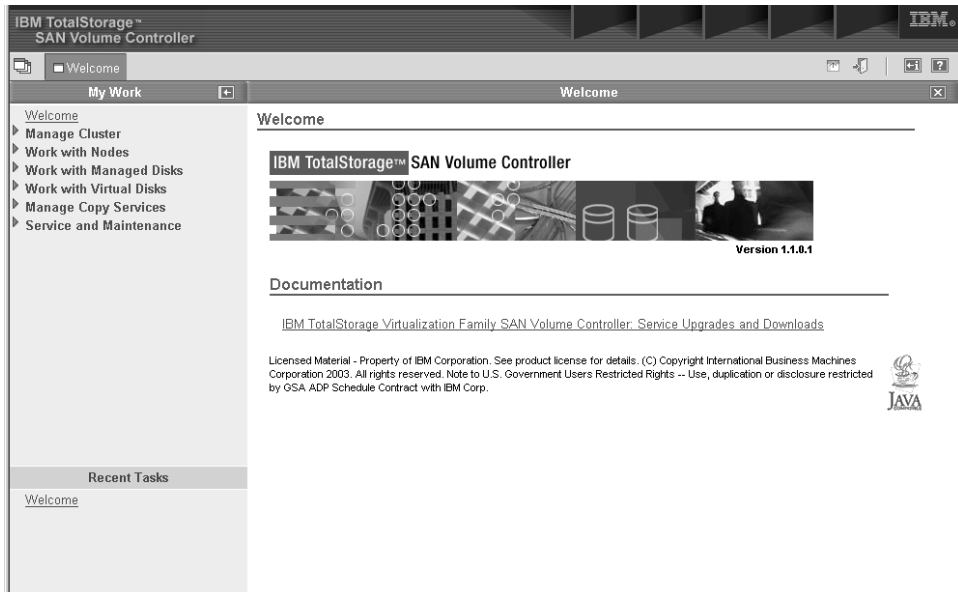

Figure 35. Welcome panel

#### Related concepts

“Clusters” on page 11

All configuration and service is performed at the cluster level.

#### Related reference

“Overview of creating a cluster using the SAN Volume Controller Console” on page 105

The create cluster wizard of the SAN Volume Controller Console enables you to create a cluster.

## Setting cluster time

You can set the cluster time for the SAN Volume Controller from the Setting Cluster Time panel.

Perform the following steps to set the cluster time:

1. Click **Manage Clusters** from the portfolio.
2. Select **Set Cluster Time** from the list and click **Go**. The Setting Cluster Time panel is displayed.

**Cluster date and time settings**

This option displays the existing Cluster Date/Time and Time Zone settings, and allows you to update the values, if required.

**Existing settings**

Cluster date	08-Apr-2003
Cluster time	17:29:44
Cluster time zone	UTC

**New settings**

Date (01-31)       Month (01-12)       Year (20xx)

Hours (00-23)       Minutes (00-59)

Time Zone  
 ▼

Update cluster time/date  
 Update cluster time zone

Figure 36. Cluster date and time settings panel

3. Perform the following steps to change the information in the window:
  - a. Type the changes to any of the input field parameters or select a new time zone from the list.
  - b. When you have made the changes, select the appropriate check-boxes to update the time, the time zone, or both.
  - c. Click **Update** to submit the update request to the node.

**Related concepts**

“Clusters” on page 11

All configuration and service is performed at the cluster level.

**Related reference**

“Overview of creating a cluster using the SAN Volume Controller Console” on page 105

The create cluster wizard of the SAN Volume Controller Console enables you to create a cluster.

## Displaying cluster properties using the SAN Volume Controller Console

You can display cluster properties from the View Cluster properties panel.

Perform the following steps to display the cluster properties:

1. Click **Manage Cluster** from the portfolio.
2. Click **View Cluster properties** to view the properties for the cluster. The Cluster Properties notebook is displayed.

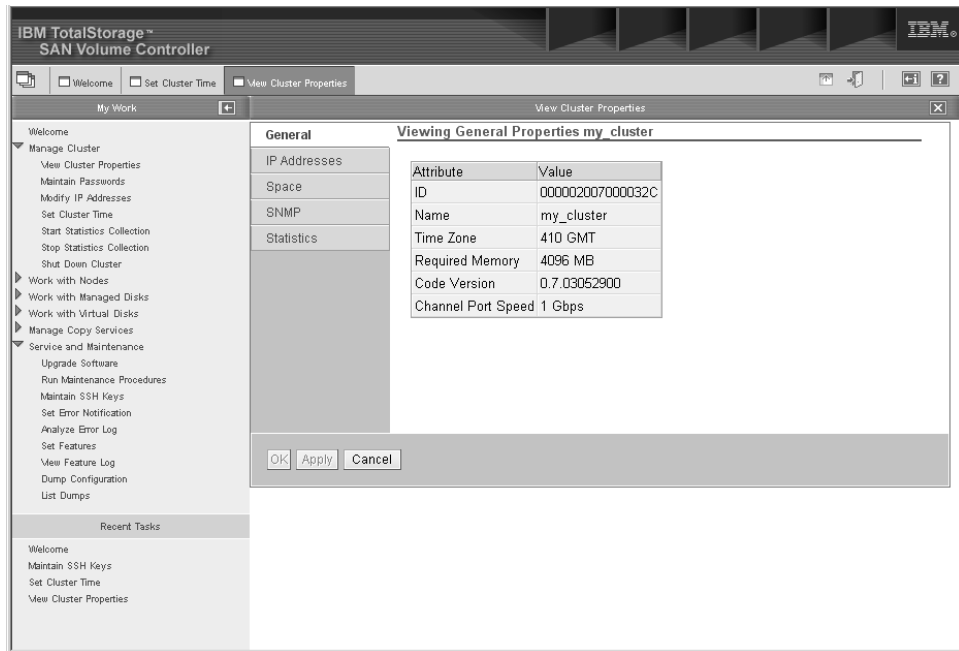

Figure 37. View Cluster properties panel

3. Click:
  - a. **General** tab in the notebook to display the general properties.
  - b. **IP Addresses** to view, the service IP address, the subnet mask, and the default gateway addresses.
  - c. **Space** to view the space and capacity within the virtual disks (VDisks) and managed disk (MDisk) groups.
  - d. **SNMP** to view the SNMP details.
  - e. **Statistics** to view the cluster statistics details.
  - f. **Remote Copy** to view the remote copy properties of the cluster.

#### Related reference

“Overview of creating a cluster using the SAN Volume Controller Console” on page 105

The create cluster wizard of the SAN Volume Controller Console enables you to create a cluster.

---

## Scenario: typical usage for the SAN Volume Controller Console

This hypothetical example describes a scenario for configuring the SAN Volume Controller using the SAN Volume Controller Console.

The main focus of the following example is to provide storage to a host system.

For example, you wish to provide a host system with two disks and create a FlashCopy of these two disks. The copy is to be made available to a second host. These two hosts require that the host objects that are created, correspond with the group of WWPNs presented by their fibre-channel HBAs to the SAN. You also need to create four virtual disks, one for each of the disks that are to be presented to the hosts. Once the VDIs are created, you can map two of them to each host. In order to create the VDIs you need to have a managed disk group to be able to create them from. You wish to spread the 8 managed disks across two groups and

create the source VDIs from one and the target VDIs from the other. In order to create any of these objects you need to create a cluster and at least one more node to the cluster.

The following steps illustrates how this can be done:

1. Create a cluster.
2. Configure the cluster with an IP address of 9.20.123.456, a fabric speed of 2 Gb/s. Name the cluster examplecluster.
3. Launch the SAN Volume Controller application for the cluster. A secondary browser window opens to the SAN Volume Controller Web application. Now you can work with the specific SAN Volume Controller cluster which you selected.
4. Add nodes
  - knode and lnode to the I/O group called io\_group0 in the examplecluster cluster
  - mnode and nnode to the I/O group called io\_group1 in the examplecluster cluster
5. Create the managed disk (MDisk) groups maindiskgroup and bkpdiskgroup
6. Create four virtual disks (VDIs)
  - 2 VDIs from maindiskgroup
  - 2 VDIs from bkpdiskgroup
7. Create two host objects
  - A host object called demohost1 with HBAs that have WWPNs of 210100e08b251dd4, and 210100e08b251dd5
  - A host object called demohost2 with HBAs that have WWPNs of 210100e08b251dd6, and 210100e08b251dd7
8. Create the VDisk-to-host mappings
  - Create a VDisk-to-host mapping for demohost1
  - Create a VDisk-to-host mapping for demohost2

Once this step is complete, you have successfully created storage on your host system.
9. Create a FlashCopy consistency group called maintobkpcopy and add the two FlashCopy mappings to it.

**Note:** You must first create FlashCopy mappings to define the relationships.

#### **Related tasks**

“Create cluster from the front panel” on page 69

After you have created a pair of nodes, you can now create a cluster from the front panel.

“Adding nodes to a cluster” on page 120

You can add a node to a cluster from the Adding Nodes to a cluster panel.

“Configuring a cluster using the SAN Volume Controller Console” on page 106

Once you’ve created a pair of nodes, you will then need to create and configure a cluster.

“Displaying node properties using the SAN Volume Controller Console” on page 125

You can display the node properties using the Viewing general details panel.

“Creating managed disk groups” on page 125

You can create a new managed disk (MDisk) group using the Create a Managed Disk Group wizard.

“Creating virtual disks” on page 127

You can create virtual disks using the Create virtual disks wizard.

“Creating hosts” on page 131

You can create a new host object from the Creating Hosts panel.

“Showing VDIs mapped to a host” on page 132

You can show the VDIs that are mapped to a host by using the Viewing Virtual Disks panel.

“Creating consistency groups” on page 133

You can create a FlashCopy consistency group from the Creating FlashCopy consistency groups panel.

“Creating FlashCopy mappings” on page 133

You can create a FlashCopy mapping from the Creating FlashCopy Mappings panel.

#### **Related information**

“Using image mode virtual disks” on page 127

Ensure that you are familiar with using image mode virtual disks.

## **Adding nodes to a cluster**

You can add a node to a cluster from the Adding Nodes to a cluster panel.

**Attention:** Before adding a node to a cluster, make sure that the switch zoning is configured such that the node being added is in the same zone as all other nodes in the cluster. In particular, if you are replacing a node and the switch is zoned by worldwide port name (WWPN) rather than by switch port, make sure the switch is configured such that the node being added is in the same VSAN/zone as you must update the switch configuration.

For availability purposes, you should connect the nodes in an input/output (I/O) group to different Uninterruptible Power Sources (UPSs).

Before adding a node to the cluster check to see if any of the following conditions are true:

- The cluster has more than one I/O group.
- The node being added to the cluster uses physical node hardware or a slot which has previously been used as for a node in the cluster.
- The node being added to the cluster uses physical node hardware or a slot which has previously been used for a node in another cluster and both clusters have visibility to the same hosts and backend storage.

**Attention:** If any of these conditions are true, then you must perform the following special procedures. Failure to perform the special procedure is likely to result in the corruption of all data managed by the cluster.

Perform the following steps to add a node to a cluster:

1. Click **Work with Nodes** from the portfolio.
2. Click **Nodes** from the portfolio. The Viewing Nodes panel is displayed.
3. Select **Add a Node** from the list and click **Go**. The Adding nodes to a cluster panel is displayed.

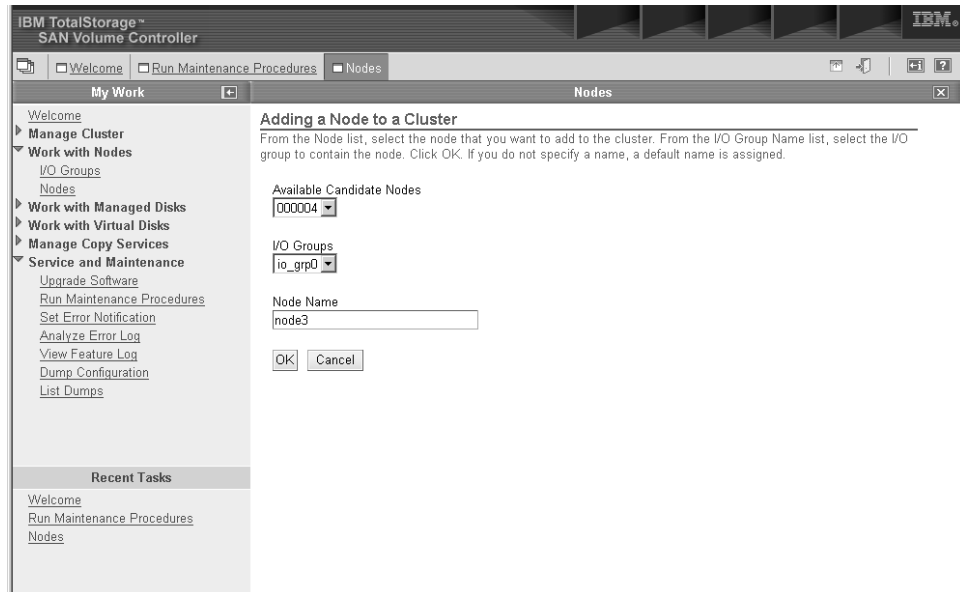

Figure 38. SAN Volume Controller Console Nodes panel

4. From the list of candidate nodes, select the number of the node that you want to add.
5. Select the I/O group for the node.

### Special procedures when adding a node to a cluster

If any of the previous conditions are true, then the following special procedures apply. These special procedures apply when you use either the **svctask addnode** command or the SAN Volume Controller Console. When a node is added to a cluster then either:

- The node must be added back to the same I/O group that it was previously in.

**Note:** The WWNN of the nodes in the cluster can be determined using the command: `svcinfolnode` or, if this information is not available, then

- *Before* the node is added back into the cluster all the hosts using the cluster must be shut down. The node must then be added before the hosts are rebooted. Or, if the I/O group information is not available and it is inconvenient to shutdown and reboot all of the hosts using the cluster, then
- On all the hosts connected to the cluster, unconfigure the Fibre Channel adapter device driver, the disk device driver, and the SDD device driver, before you add the node to the cluster.

Re-configure the Fibre Channel adapter device driver, the disk device driver, and the SDD device driver, after adding the node into the cluster.

**Note:** This may not be possible on all operating systems in all circumstances.

### Background

Applications on host systems direct I/O operations to filesystems or logical volumes which are mapped by the operating system to vpaths which are pseudo disk objects supported by the SDD driver.

The SDD driver maintains an association between a vpath and a SAN Volume Controller VDisk. This association uses an identifier (UID) which is unique to the VDisk and is never re-used. This allows the SDD driver to unambiguously associate vpaths with VDIs.

The SDD device driver operates within a protocol stack which also contains Disk and Fibre Channel device drivers which allow it to communicate with the SAN Volume Controller using the SCSI protocol over Fibre Channel as defined by the ANSI FCS standard. The addressing scheme provided by these SCSI and Fibre channel device drivers uses a combination of a SCSI Logical unit number (LUN) and the World Wide Name for the Fibre Channel Node and Ports.

In the event of errors occurring, error recovery procedures (ERPs) operate at various tiers in the protocol stack. Some of these ERPs cause I/O to be redriven using the same WWN and LUN numbers which were previously used.

The SDD device driver does not check the association of the VDisk with the VPath on every I/O that it performs.

Perform the following steps to add nodes to the cluster:

1. From the Welcome panel, click **Work with Nodes** in the portfolio.
2. Click **Nodes** in the portfolio. The Nodes panel is displayed.

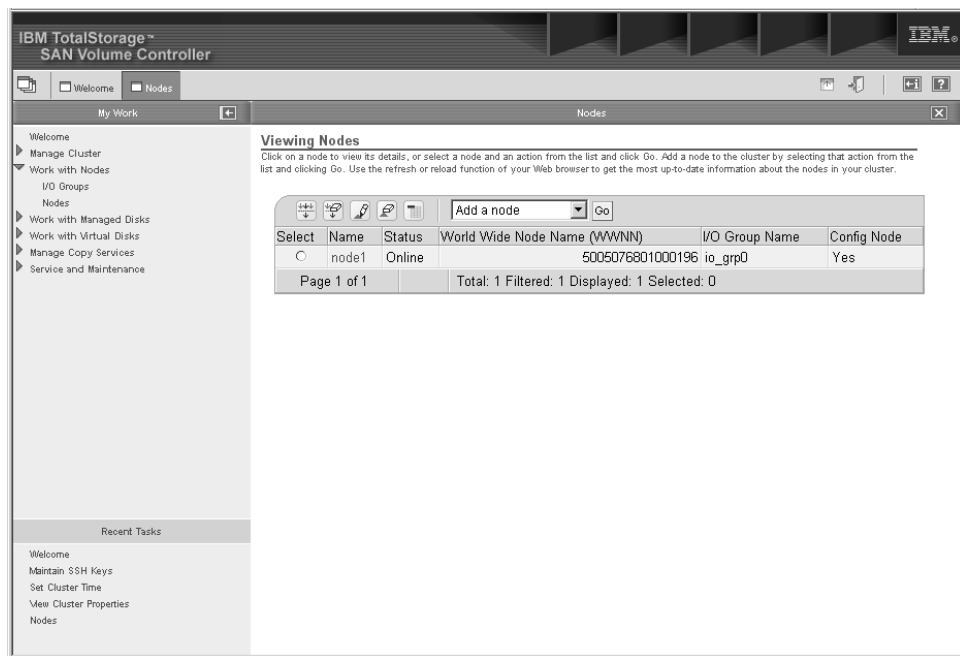

Figure 39. Nodes panel

3. Select **Add Node** from the drop down list and click **Go**.



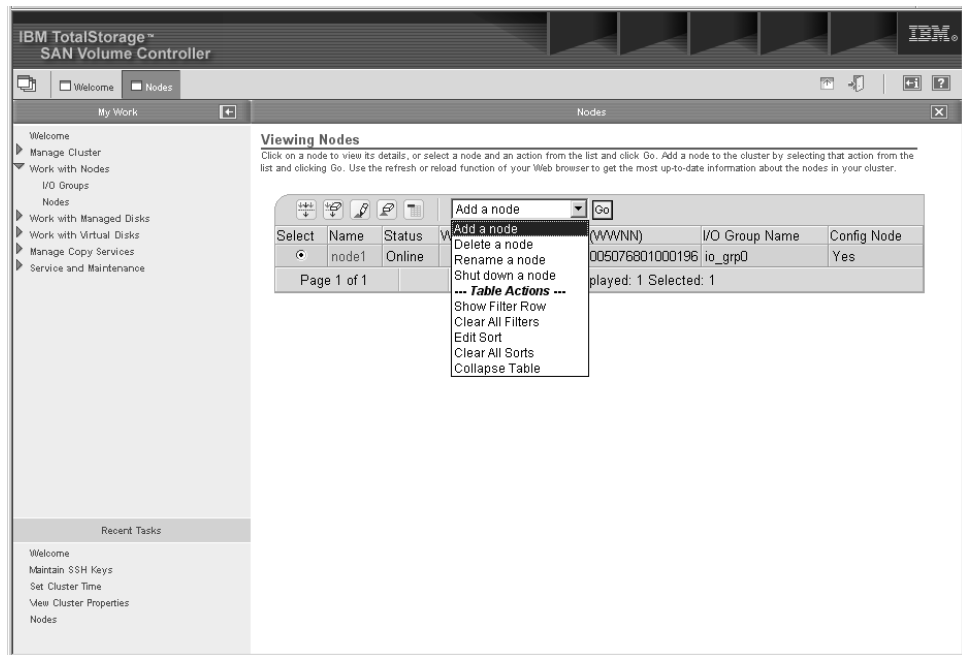

Figure 40. Add node drop down list

4. If you are re-adding a node to the SAN, ensure that you are adding the node to the same I/O group that it was removed from. Failure to do this can result in data corruption. Use the information that was recorded when the node was originally added to the cluster. If you do not have access to this information, call IBM Service to add the node back into the cluster without corrupting the data. If you are adding the node into the cluster for the first time, record the following information:
  - a. Card **Node** serial number
  - a. All WWPNs
  - b. I/O group that contains the node

This can avoid a possible data corruption exposure if the node must be removed from and re-added to the cluster.

**Note:** This warning also is displayed on the SAN Volume Controller Console panel when adding the node.

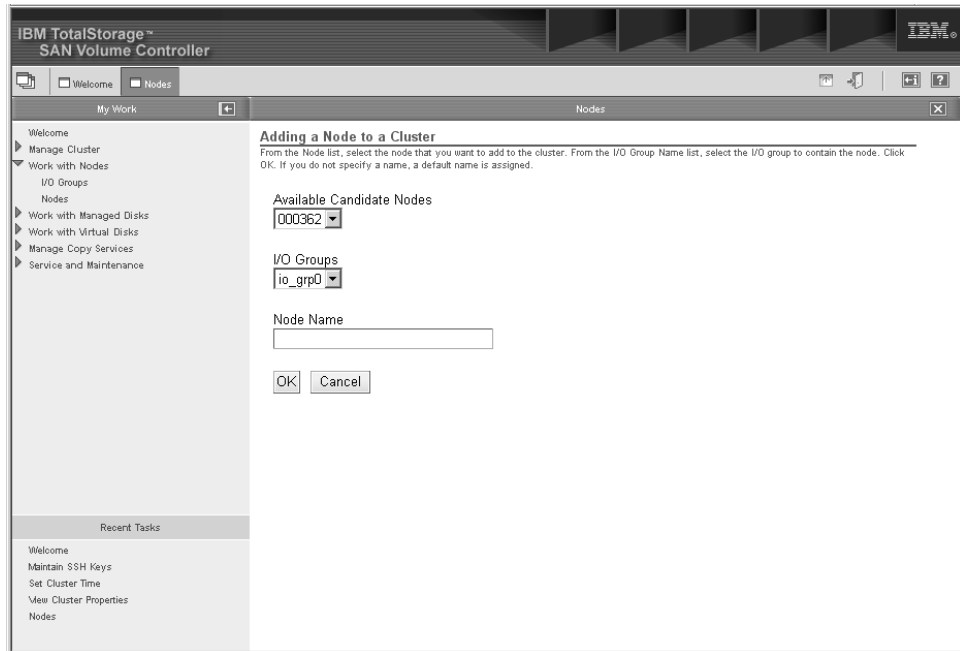

Figure 41. Add Node to Cluster panel

**Note:** Each node in an I/O group must be connected to a different uninterruptible power supply. If you do not supply a name, the cluster assigns a default name to the object. Whenever possible you should provide a meaningful name for objects to make identifying that object easier in the future.

### Hypothetical scenarios where the special procedures may apply.

The following are two hypothetical scenarios where the special procedures may apply:

- Four nodes of a 8-node cluster have been lost because of a complete failure of a pair of uninterruptible power supplies. In this case the four nodes must be added back into the cluster using the **svctask addnode** command or the SAN Volume Controller Console.
- A user decides to delete four nodes from the cluster and add them back into the cluster using the **svctask addnode** command or the SAN Volume Controller Console.

#### Related concepts

“Clusters” on page 11

All configuration and service is performed at the cluster level.

“Nodes and clusters” on page 11

A SAN Volume Controller node is a single processing unit, which provides virtualization, cache, and copy services for the SAN.

#### Related information

“Scenario: typical usage for the SAN Volume Controller Console” on page 118

This hypothetical example describes a scenario for configuring the SAN Volume Controller using the SAN Volume Controller Console.

## Displaying node properties using the SAN Volume Controller Console

You can display the node properties using the Viewing general details panel.

Perform the following steps to display the node properties:

1. Click **Work with Nodes** from the portfolio.
2. Click **Nodes** from the portfolio. The Nodes panel is displayed.
3. Select the name of the node that you want to view the details for. The Viewing General Details panel is displayed.

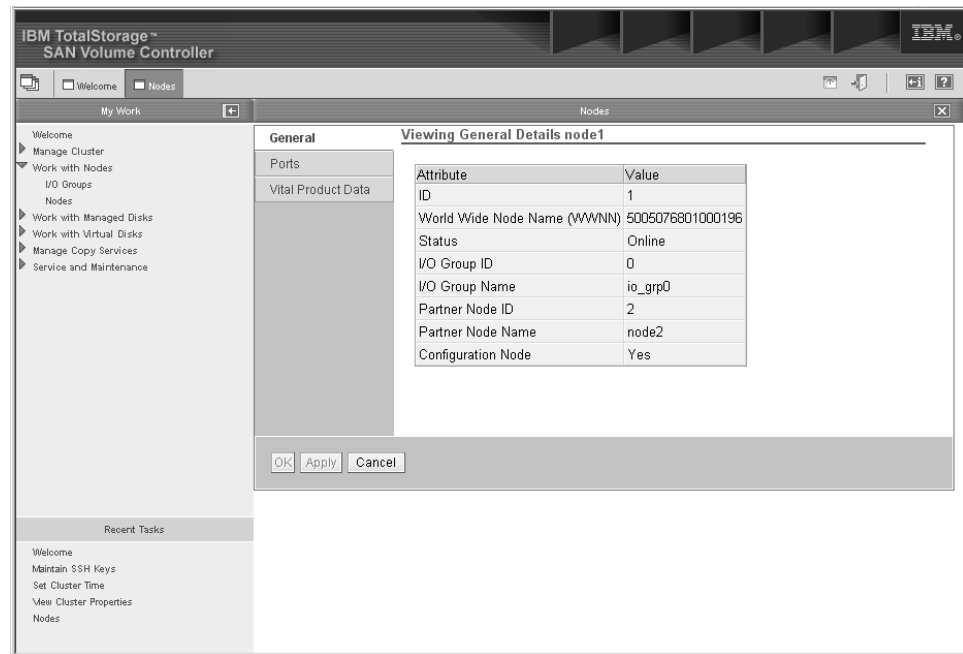

Figure 42. Viewing general details panel

4. Click **Ports** to view the WWPN port details. The Viewing Port Details panel for node1 is displayed.
5. Click **Vital Product Data** to view the node hardware details. The Viewing Vital Product Data panel is displayed.

### Related information

“Scenario: typical usage for the SAN Volume Controller Console” on page 118

This hypothetical example describes a scenario for configuring the SAN Volume Controller using the SAN Volume Controller Console.

## Creating managed disk groups

You can create a new managed disk (MDisk) group using the Create a Managed Disk Group wizard.

If you intend to keep the virtual disk allocation within one disk controller system, you should ensure that the MDisk group that corresponds with a single disk controller system is presented by that disk controller system. This also enables non-disruptive migration of data from one disk controller system to another disk controller system and simplifies the decommissioning process should you wish to decommission a disk controller system at a later time.

You should also ensure that all MDisks allocated to a single MDisk group are of the same RAID type. This ensures that a single failure of a physical disk in the disk controller system does not take the entire group offline. For example, if you had three RAID-5 arrays in one group and added a non-RAID disk to this group, if the non-RAID disk fails then you will lose access to all the data striped across the group. Similarly, for performance reasons you should not mix RAID types.

Perform the following steps to create a new MDisk group:

1. Click **Work with Managed Disks** from the portfolio.
2. Click **Managed Disk Groups** from the portfolio. The Filtering Managed Disk Groups panel is displayed.

**Note:** The filter panels can be used to prefilter the list of objects that are displayed. This reduces the number of objects returned to the . This can be useful when you have a large number of objects (for example 4096 MDisks or 1024 VDIs) and you do not want to display them all. You can bypass the filtering and display all objects by clicking **Bypass Filter**.

3. Specify the filter criteria that you want to use. Click **OK** or click **Bypass Filter** to display all objects of this type. The Viewing Managed Disk Groups panel is displayed.
4. Select **Create MDisk Group** from the list. Click **Go**. The Create a Managed Disk Group wizard is displayed.
5. Type the name of the MDisk group and add the MDisks from the **Managed Disk Candidates** list.

In our hypothetical scenario, type

maindiskgroup

add MDisks

mdsk0, mdsk1, mdsk2, mdsk3

from the **Managed Disk Candidates** list.

6. Select the extent size from the list.

In our hypothetical scenario, select

32

for the extent size used within this MDisk group and click **OK**.

7. Repeat steps 4 through 6 for all of the MDisk groups that you want to create.

In our hypothetical scenario, repeat steps 4 through 6, in which the second MDisk group is named

bkpdiskgroup

with the following MDisks attached,

mdsk4, mdsk5, mdsk6, mdsk7

The extent size will be

16

MB.

### Related concepts

“Managed disk groups” on page 24

An *MDisk group* is a collection of MDisks that jointly contain all the data for a specified set of virtual disks (VDisks).

“Managed disks” on page 21

A managed disk (MDisk) is a logical disk (typically a RAID array or partition thereof) that a storage subsystem has exported to the SAN fabric to which the nodes in the cluster are attached.

### Related reference

“Configuration guidelines” on page 254

Follow the guidelines and procedures outlined in this section to make the most of the performance available from your storage subsystems and to avoid potential I/O problems.

“Optimal managed disk group configurations” on page 256

A managed disk group provides the pool of storage from which virtual disks will be created. It is therefore necessary to ensure that the entire pool of storage provides the same performance and reliability characteristics.

### Related information

“Scenario: typical usage for the SAN Volume Controller Console” on page 118

This hypothetical example describes a scenario for configuring the SAN Volume Controller using the SAN Volume Controller Console.

## Creating virtual disks

You can create virtual disks using the Create virtual disks wizard.

Perform the following steps to create virtual disks:

1. Click **Work with Virtual Disks** from the portfolio.
2. Click **Virtual Disks** from the portfolio. The Filtering Virtual Disks panel is displayed.
3. Specify the filter criteria that you want to use. Click **OK**. The Viewing Virtual Disks panel is displayed.
4. Select **Create virtual disks** from the list. Click **Go**. The Create Virtual Disks wizard is displayed.
5. Perform the following steps to complete the wizard:
  - a. Select an I/O group, preferred node, and managed disk group.

**Note:** If there are no MDisk groups to select, you will be prompted to create one.

- b. Select the type and quantity of the virtual disks that you want to create.
- c. Type a name for the virtual disks.
- d. Set the attributes, such as MDisk candidates, capacity of the VDIs, and type of VDIs, for the virtual disks.
- e. Verify the attributes.

### Related information

“Scenario: typical usage for the SAN Volume Controller Console” on page 118

This hypothetical example describes a scenario for configuring the SAN Volume Controller using the SAN Volume Controller Console.

## Using image mode virtual disks

Ensure that you are familiar with using image mode virtual disks.

An image mode VDisk provides a direct block-for-block translation from the managed disk to the virtual disk with no virtualization. This mode is intended to allow virtualization of managed disks which already contain data which was written directly, not through a SAN Volume Controller. Image mode virtual disks have a minimum size of 1 block (512 bytes) and always occupy at least one extent.

Image mode managed disks are members of a managed disk group, but, they do not contribute to free extents.

In order for a virtual disk to be online it is necessary for ALL managed disks in the managed disk group associated with the virtual disk to be online. This applies to image mode virtual disks as well as managed mode virtual disks. A virtual disk will be offline if any managed disk in the managed disk group is offline even if that managed disk does not contribute any extents to the virtual disk in question or even if the managed disk has no allocated extents.

An image mode VDisk behaves just as a managed mode VDisk in terms of Remote Copy and FlashCopy. Image mode VDIsks are different from managed mode in two ways:

- Migration. As soon as an image mode disk is migrated, it becomes a managed mode disk.
- Quorum disks. Image mode disks cannot be quorum disks. This means that a cluster with only image mode disks does not have a quorum disk.

#### **Related tasks**

“Exposing LUN’s on your existing storage to the cluster via switch zoning”

You can expose LUN’s on your existing storage to the cluster via switch zoning.

“Image mode VDisk migration” on page 129

In order to perform any type of migration activity on an image mode VDisk, the image mode disk must first be converted into a managed mode disk. This happens automatically whenever any kind of migration activity is attempted.

Once this image to managed migration operation has occurred, the VDisk becomes a managed mode virtual disk and is treated the same way as any other managed mode VDisk. Once a VDisk has been converted into managed mode there is no way to convert it back to image mode.

“Virtual disk-to-host mappings” on page 131

You can view the virtual disk-to-host mappings from the Virtual Disk-to-Host Mappings panel.

#### **Related information**

“Scenario: typical usage for the SAN Volume Controller Console” on page 118

This hypothetical example describes a scenario for configuring the SAN Volume Controller using the SAN Volume Controller Console.

### **Exposing LUN’s on your existing storage to the cluster via switch zoning**

You can expose LUN’s on your existing storage to the cluster via switch zoning.

Ensure that you have already created a cluster.

#### **CAUTION:**

**Ensure that no LUNs are zoned or mapped so that they can be seen by both SAN Volume Controller and a host at the same time. Also ensure that all LUNs can be seen by all SAN Volume Controller nodes in the cluster on both of the redundant fabrics.**

#### **Related tasks**

“Adding a new storage controller to a running configuration using the SAN Volume Controller Console” on page 266  
You can add a new storage controller to your SAN at any time.

#### **Related information**

“Using image mode virtual disks” on page 127  
Ensure that you are familiar with using image mode virtual disks.

### **Image mode VDisk migration**

In order to perform any type of migration activity on an image mode VDisk, the image mode disk must first be converted into a managed mode disk. This happens automatically whenever any kind of migration activity is attempted. Once this image to managed migration operation has occurred, the VDisk becomes a managed mode virtual disk and is treated the same way as any other managed mode VDisk. Once a VDisk has been converted into managed mode there is no way to convert it back to image mode.

Once this special migration operation has occurred, the VDisk becomes a managed mode virtual disk and is treated in the same way as any other managed mode VDisk.

#### **Related tasks**

“Migration methods”  
There are several methods to choose from when migrating image mode VDIs into managed mode VDIs.  
“Importing data by creating an image mode VDisk” on page 130  
You can migrate LUN’s into virtual disks (VDIs).

#### **Related information**

“Using image mode virtual disks” on page 127  
Ensure that you are familiar with using image mode virtual disks.

### **Migration methods**

There are several methods to choose from when migrating image mode VDIs into managed mode VDIs.

There are several methods to migrate an image mode virtual disk into a managed mode virtual disk:

- If your image mode VDisk is in the same MDisk group than the MDIs on which you want to migrate the extents, then you can:
  - Migrate multiple extents.
  - Migrate all the in use extents from a MDisk.
- If your cluster has two MDisk groups, one for the image mode VDisk and one for the managed mode VDIs, you can:
  - Migrate a VDisk from one MDisk group to another.
  - You could also choose to migrate the MDisk out of one group and into another, where both groups have a mixture of image and managed mode VDIs.

The recommended method is to have one MDisk group for all the image mode VDIs and other MDisk groups for the managed mode VDisk and to use the migrate VDisk facility.

**Remember:** Ensure that there are enough extents available in the target MDisk group. Once the image mode VDisk has been migrated there is no way to migrate it back.

### Related tasks

“Image mode VDisk migration” on page 129

In order to perform any type of migration activity on an image mode VDisk, the image mode disk must first be converted into a managed mode disk. This happens automatically whenever any kind of migration activity is attempted. Once this image to managed migration operation has occurred, the VDisk becomes a managed mode virtual disk and is treated the same way as any other managed mode VDisk. Once a VDisk has been converted into managed mode there is no way to convert it back to image mode.

### Importing data by creating an image mode VDisk

You can migrate LUN's into virtual disks (VDisks).

Ensure that you define which managed disk group you want the image disk to belong too.

#### CAUTION:

**If you import the data onto a SAN Volume Controller in image mode without first creating a quorum disk then you are vulnerable to a loss of access to data should nodes drop out of the cluster.**

Before importing disks in image mode, ensure that you create space to use for your quorum disks. Create three MDisks which are NOT to be used as image mode VDIs. Do not have any data on them. The three MDisks should be placed into a MDisk group. The three MDisks should have a size of at least 512 MB each and be allocated from one of the controller types which supports quorum disks.

An image mode VDisk provides a direct block-for-block translation from the managed disk to the virtual disk with no virtualization. This mode is intended to allow virtualization of managed disks which already contain data which was written directly, not through a SAN Volume Controller. Image mode virtual disks have a minimum size of 1 block (512 bytes) and always occupy at least one extent.

Many of the facilities of SAN Volume Controller are available for use on image mode VDIs. You can decide to leave your VDIs as image mode VDIs. In order to expand or reduce the size of the VDIs or if the VDIs need to be migrated, then they will need to be converted into managed mode. This will happen automatically when the VDIs are migrated. Specifically, it can be one in one of the following ways:

- Using the **svctask migratevdisk** command which requires another MDisk group to already exist. This also requires that the other MDisk group has the same extent size and that the MDisk group being migrated to has adequate space, or
- Using the **svctask migrateexts** or the **svctask rmmddisk -force** command which will force a migration of any VDIs occupying space on the MDisk being deleted.

#### Note:

- The **svctask rmmddisk -force** command will only work if there are enough free extents in the group.
- Image mode MDIs do *not* contribute to the free extent pool because all their extents are used for the corresponding image mode VDisk.
- Managed MDIs do contribute to free extents, however, it is possible that there won't be enough. You can issue the **svctask addmddisk** command to add more managed MDIs to the group.



- Similarly, if you want to migrate your image mode VDisk to another group, using the **svctask migratevdisk** command, ensure there are enough free extents in the target group.

#### **Related tasks**

“Image mode VDisk migration” on page 129

In order to perform any type of migration activity on an image mode VDisk, the image mode disk must first be converted into a managed mode disk. This happens automatically whenever any kind of migration activity is attempted. Once this image to managed migration operation has occurred, the VDisk becomes a managed mode virtual disk and is treated the same way as any other managed mode VDisk. Once a VDisk has been converted into managed mode there is no way to convert it back to image mode.

### **Virtual disk-to-host mappings**

You can view the virtual disk-to-host mappings from the Virtual Disk-to-Host Mappings panel.

Perform the following steps to view your virtual disk-to-host mappings:

1. Click **Work With Virtual Disks** in the portfolio.
2. Click **Virtual Disk-to-Host Mappings** in the portfolio. The Filtering Virtual Disk-to-Host Mappings panel is displayed.
3. Specify the filter criteria that you want to use. Click **OK**. The Virtual Disk-to-Host Mappings panel is displayed.

#### **Related concepts**

“Virtual disk-to-host mapping” on page 30

Virtual disk-to-host mapping is the process of controlling which hosts have access to specific virtual disks (VDisks) within the SAN Volume Controller.

#### **Related information**

“Using image mode virtual disks” on page 127

Ensure that you are familiar with using image mode virtual disks.

## **Creating hosts**

You can create a new host object from the Creating Hosts panel.

Perform the following steps to create a new host object:

1. Click **Work with Virtual Disks** in the portfolio.
2. Click **Hosts** in the portfolio. The Filtering Hosts panel is displayed.
3. Specify the filter criteria that you want to use. Click **OK**. The Hosts panel is displayed.
4. Select **Create Host** from the list. Click **Go**. The Creating Hosts panel is displayed.
5. Type the name of the logical host object.

**Note:** If you do not specify a name, a default name is assigned (for example, host0). Then assign a WWPN. A WWPN consists of 16 hexadecimal digits (for example, 210100e08b251dd4). You can select a WWPN from the list of candidates or you can manually enter a WWPN that is not on the list of candidates. Multiple WWPN's can be assigned to a single logical host object. Click **OK**.

In our hypothetical scenario, because a host name was not specified, the default name is:

host0

The World Wide Port Names (WWPNs) assigned to the host are:

210100e08b251dd4, 210100e08b251dd5

These WWPNs can be found by using your specific switches management application.

6. Repeat steps 4 on page 131 through 5 on page 131 for each host object that you want to create.

In our hypothetical scenario, repeat steps 4 on page 131 through 5 on page 131 and name the host:

demohost2

The World Wide Port Names (WWPNs) assigned to the host are:

210100e08b251dd6, 210100e08b251dd7

#### **Related concepts**

“Host objects” on page 29

A host system is an open-systems computer that is connected to the switch through a fibre-channel interface.

#### **Related information**

“Scenario: typical usage for the SAN Volume Controller Console” on page 118

This hypothetical example describes a scenario for configuring the SAN Volume Controller using the SAN Volume Controller Console.

## **Showing VDisks mapped to a host**

You can show the VDisks that are mapped to a host by using the Viewing Virtual Disks panel.

If a number of new VDisks are mapped to a host, and a number of devices are already running I/O operations, then a lot of errors may be logged. At the time the new VDisk is mapped, multiple recoverable errors can be logged in the event log. Decoding of the event log shows the errors to be caused by a check condition. The error states that there has been a change to the device information since the last LUN operation.

Perform the following steps to show the VDisks that are mapped to a host:

1. Click **Work with Virtual Disks** in the portfolio.
2. Click **Hosts** in the portfolio. The Filtering Hosts panel is displayed.
3. Specify the filter criteria that you want to use. Click **OK**. The Hosts panel is displayed.
4. Select the host and select **Show the VDisks Mapped to this Host** from the list. Click **Go**.

The virtual disks mapped to this host are displayed in the Viewing Virtual Disks panel

#### **Related concepts**

“Host objects” on page 29

A host system is an open-systems computer that is connected to the switch through a fibre-channel interface.

#### **Related information**

“Scenario: typical usage for the SAN Volume Controller Console” on page 118

This hypothetical example describes a scenario for configuring the SAN Volume Controller using the SAN Volume Controller Console.

## **Creating consistency groups**

You can create a FlashCopy consistency group from the Creating FlashCopy consistency groups panel.

Perform the following steps to create a FlashCopy consistency group:

1. Click **Manage Copy Services** in the portfolio.
2. Click **FlashCopy consistency groups** in the portfolio. The Filtering FlashCopy consistency groups panel is displayed.
3. Specify the filter criteria that you want to use. Click **OK**. The FlashCopy consistency groups panel is displayed.
4. Click **Create FlashCopy consistency groups**. The Create FlashCopy consistency groups panel is displayed.
5. Type the name of the consistency group in the **FCCGroup name** field. From the **FlashCopy Mappings** list, select the mappings you want in the consistency group and click **OK**. If you do not specify a name, a default name is assigned.

In our hypothetical scenario, the name of the consistency group is:

maintobkpfcopy

The mappings that should be added are:

main1copy, main2copy

**Note:** You could have created the FlashCopy consistency group before you created the mappings and then added the FlashCopy mappings to the consistency group. To add FlashCopy mappings in this way, you must use the Modifying FlashCopy Mapping panel or the Creating FlashCopy Mappings panel.

#### **Related concepts**

“FlashCopy consistency groups” on page 39

A consistency group is a container for mappings. You can add many mappings to a consistency group.

#### **Related information**

“Scenario: typical usage for the SAN Volume Controller Console” on page 118

This hypothetical example describes a scenario for configuring the SAN Volume Controller using the SAN Volume Controller Console.

## **Creating FlashCopy mappings**

You can create a FlashCopy mapping from the Creating FlashCopy Mappings panel.

1. Click **Manage Copy Services** in the portfolio.
2. Click **FlashCopy mappings** in the portfolio. The Filtering FlashCopy Mappings panel is displayed.

3. Specify the filter criteria that you want to use. Click **OK**. The Viewing FlashCopy Mappings panel is displayed.
4. Select **Create Mapping** from the list. Click **Go**. The Creating FlashCopy Mappings panel is displayed.
5. Type the name of the new FlashCopy mapping. In our hypothetical scenario, the name of the FlashCopy mapping is: main1copy.
6. Select the source VDisk from the list. In our hypothetical scenario, the name of the source VDisk is: maindisk1
7. Select the target VDisk from the list. In our hypothetical scenario, the name of the target VDisk is: bkpdisk1
8. Select the priority for the background copy. Click **OK**.

Repeat steps 4 through 8 for each FlashCopy mapping that you want to create.

#### **Related concepts**

“FlashCopy mappings” on page 35

A FlashCopy mapping defines the relationship between a source VDisk and a target VDisk.

#### **Related reference**

“Considerations for FlashCopy mappings” on page 257

Ensure that you’ve considered the type of I/O and frequency of update before creating the virtual disks that you wish to use in FlashCopy mappings.

#### **Related information**

“Scenario: typical usage for the SAN Volume Controller Console” on page 118

This hypothetical example describes a scenario for configuring the SAN Volume Controller using the SAN Volume Controller Console.

---

## **Advanced function FlashCopy overview**

Ensure that you are familiar with the FlashCopy advanced functions.

### **Overview**

The following sections details the advanced FlashCopy functions that you can perform using the SAN Volume Controller Console.

#### **Related tasks**

“Starting FlashCopy mappings” on page 135

You can start FlashCopy mappings from the FlashCopy Mappings panel.

“Stopping FlashCopy mappings” on page 135

You can stop FlashCopy mappings from the FlashCopy Mappings panel.

“Deleting FlashCopy mappings” on page 135

You can delete FlashCopy mappings from the FlashCopy mappings panel.

“Starting FlashCopy consistency groups” on page 136

You can start FlashCopy consistency groups from the FlashCopy Consistency Groups panel.

“Stopping FlashCopy consistency groups” on page 136

You can stop FlashCopy consistency groups from the FlashCopy Consistency Groups panel.

“Deleting FlashCopy consistency groups” on page 137

You can delete FlashCopy consistency groups using the FlashCopy consistency groups panel.

#### **Related reference**

“Valid combinations of FlashCopy and Remote Copy functions” on page 376  
The following table outlines the combinations of FlashCopy and Remote Copy functions that are valid for a single virtual disk (VDisk).

## Starting FlashCopy mappings

You can start FlashCopy mappings from the FlashCopy Mappings panel.

You can start or trigger a FlashCopy mapping from the Starting FlashCopy Mappings panel.

Perform the following steps to start a FlashCopy mapping:

1. Click **Manage Copy Services** in the portfolio.
2. Click **FlashCopy Mappings** in the portfolio. The Filtering FlashCopy mappings panel is displayed.
3. Specify the filter criteria that you want to use. Click **OK**. The Viewing FlashCopy Mappings panel is displayed.
4. Select the appropriate mapping's row from the table.
5. Select **Start a Mapping** from the drop down list. Click **Go**. The Starting FlashCopy mappings panel is displayed.

### Related concepts

“FlashCopy mappings” on page 35

A FlashCopy mapping defines the relationship between a source VDisk and a target VDisk.

## Stopping FlashCopy mappings

You can stop FlashCopy mappings from the FlashCopy Mappings panel.

You can stop a FlashCopy mapping from the Stopping FlashCopy Mappings panel.

Perform the following steps to stop a FlashCopy mapping:

1. Click **Manage Copy Services** in the portfolio.
2. Click **FlashCopy Mappings** in the portfolio. The Filtering FlashCopy Mappings panel is displayed.
3. Specify the filter criteria that you want to use. Click **OK**. The Viewing Mappings panel is displayed.
4. Select the appropriate mapping's row from the table.
5. Select **Stop a mapping** from the drop down list. Click **Go**. The Stopping FlashCopy mappings panel is displayed.

### Related concepts

“FlashCopy mappings” on page 35

A FlashCopy mapping defines the relationship between a source VDisk and a target VDisk.

## Deleting FlashCopy mappings

You can delete FlashCopy mappings from the FlashCopy mappings panel.

You can delete a FlashCopy mapping from the Deleting FlashCopy Mappings panel.

Perform the following steps to delete a FlashCopy mapping:

1. Click **Manage Copy Services** in the portfolio.

2. Click **FlashCopy mappings** in the portfolio. The Filtering FlashCopy mappings panel is displayed.
3. Specify the filter criteria that you want to use. Click **OK**. The Viewing FlashCopy mappings panel is displayed.
4. Select the appropriate mapping's row from the table.
5. Click **Delete a mapping** and click **Go** . The Deleting FlashCopy mapping panel is displayed.

#### **Related concepts**

"FlashCopy mappings" on page 35

A FlashCopy mapping defines the relationship between a source VDisk and a target VDisk.

## **Starting FlashCopy consistency groups**

You can start FlashCopy consistency groups from the FlashCopy Consistency Groups panel.

You can start or trigger a FlashCopy consistency group from the Starting FlashCopy Consistency Group panel.

Perform the following steps to start or trigger a FlashCopy consistency group:

1. Click **Manage Copy Services** in the portfolio.
2. Click **FlashCopy Consistency Groups** in the portfolio. The Filtering FlashCopy Consistency Groups panel is displayed.
3. Specify the filter criteria that you want to use. Click **OK**. The FlashCopy Consistency Groups panel is displayed.
4. Select the appropriate mapping's row from the table.
5. Click **Start Consistency Group**. The Starting FlashCopy Consistency Groups panel is displayed.

#### **Related concepts**

"FlashCopy consistency groups" on page 39

A consistency group is a container for mappings. You can add many mappings to a consistency group.

## **Stopping FlashCopy consistency groups**

You can stop FlashCopy consistency groups from the FlashCopy Consistency Groups panel.

You can stop a FlashCopy consistency group from the Stopping FlashCopy Consistency Group panel.

Perform the following steps to stop a FlashCopy consistency group:

1. Click **Manage Copy Services** in the portfolio.
2. Click **FlashCopy Consistency Groups** in the portfolio. The Filtering FlashCopy Consistency Groups panel is displayed.
3. Specify the filter criteria that you want to use. Click **OK**. The FlashCopy Consistency Groups panel is displayed.
4. Select the appropriate mapping's row from the table.
5. Click **Stop Consistency Group**. The Stopping Consistency Groups panel is displayed.

#### **Related concepts**

“FlashCopy consistency groups” on page 39

A consistency group is a container for mappings. You can add many mappings to a consistency group.

## Deleting FlashCopy consistency groups

You can delete FlashCopy consistency groups using the FlashCopy consistency groups panel.

You can delete a FlashCopy consistency group from the Deleting FlashCopy consistency groups panel.

Perform the following steps to delete a FlashCopy consistency groups:

1. Click **Manage Copy Services** in the portfolio.
2. Click **FlashCopy consistency groups** in the portfolio. The Filtering FlashCopy consistency groups panel is displayed.
3. Specify the filter criteria that you want to use. Click **OK**. The FlashCopy consistency groups panel is displayed.
4. Select the appropriate mapping's row from the table.
5. Click **Delete Consistency Groups**. The Delete Consistency Groups panel is displayed.

### Related concepts

“FlashCopy consistency groups” on page 39

A consistency group is a container for mappings. You can add many mappings to a consistency group.

“FlashCopy” on page 32

FlashCopy is a copy service available with the SAN Volume Controller.

---

## Advanced functions overview for the SAN Volume Controller Console

You can perform “advanced” functions using the SAN Volume Controller Console.

### Related tasks

“Determining the WWPNs for a node using the SAN Volume Controller Console” on page 138

To determine the WWPNs of a node using the SAN Volume Controller Console, complete these steps.

“Determining the relationship between VDisks and MDisks using the SAN Volume Controller Console” on page 138

Ensure that you understand the relationship between VDisks and MDisks using the SAN Volume Controller Console.

“Determining the relationship between managed disks and RAID arrays or LUNs using the SAN Volume Controller Console” on page 139

Each MDisk corresponds with a single RAID array, or a single partition on a given RAID array. Each RAID controller will define a LUN number for this disk. The LUN number and controller name or ID are needed to be able to determine the relationship between MDisks and RAID arrays or partitions.

“Increasing the size of your cluster using the SAN Volume Controller Console” on page 139

To increase the size of a cluster, complete these tasks.

“Replacing a faulty node with a spare node using the SAN Volume Controller Console” on page 142

To replace a faulty node in the cluster using the SAN Volume Controller Console, complete these tasks.

“Recovering from offline VDisks after a node or an I/O group failed” on page 146  
If you have lost both nodes in an I/O group and have therefore, lost access to all the VDisks that are associated with the I/O group, then you must perform one of the following procedures to regain access to your VDisks. Depending on the failure type, you may have lost data that was cached for these VDisks, therefore, they have gone offline.

## Determining the WWPNs for a node using the SAN Volume Controller Console

To determine the WWPNs of a node using the SAN Volume Controller Console, complete these steps.

Perform the following steps to determine a node's WWPN's:

1. List the nodes in the cluster by opening the **Work with Nodes** panel.
2. For the node or nodes in question, select the node name link to view the node details.
3. Select the ports tab and note each WWPN.

### Related information

“Advanced functions overview for the SAN Volume Controller Console” on page 137

You can perform “advanced” functions using the SAN Volume Controller Console.

## Determining the relationship between VDisks and MDisks using the SAN Volume Controller Console

Ensure that you understand the relationship between VDisks and MDisks using the SAN Volume Controller Console.

Perform the following steps to determine the relationship between VDisks and MDisks:

1. Click **Work with VDisks** from the portfolio.
2. Select the VDisk that you want to view the relationship between this VDisk and its MDisks.
3. Select the **Show MDisks** task. The Work with MDisks panel is displayed. This panel lists the MDisks and make up the selected VDisk. Perform the following steps to determine the relationship between MDisks and VDisks:
  - a. Click **Work with MDisks** from the portfolio.
  - b. Select the VDisk that you want to view the relationship between this VDisk and its MDisks .
  - c. Select the **Show VDisks** task. The Work with VDisks panel is displayed. This panel lists the VDisks and make up the selected MDisk.

### Related information

“Advanced functions overview for the SAN Volume Controller Console” on page 137

You can perform “advanced” functions using the SAN Volume Controller Console.



## Determining the relationship between managed disks and RAID arrays or LUNs using the SAN Volume Controller Console

Each MDisk corresponds with a single RAID array, or a single partition on a given RAID array. Each RAID controller will define a LUN number for this disk. The LUN number and controller name or ID are needed to be able to determine the relationship between MDisks and RAID arrays or partitions.

Perform the following steps to determine the relationship between MDisks and RAID arrays:

1. Click **Work with MDisks** from the portfolio.
2. Select the MDisk to view the details. Write down the controller name and controller LUN number.
3. Click the **Work with Disk Controllers** panel.
4. In the filter screen, enter the controller name in the **Name** field. The panel displayed should show just the one controller.
5. Select the name to show the detailed view of the given controller. Write down the vendor ID and the product ID and WWNN and use these to determine the controller that is presented to the MDisk.
6. From the native user interface for the given controller, list the LUNs it is presenting and match the LUN number with that noted in 2. This will tell you the exact RAID array and partition that corresponds with the MDisk.

### Related information

“Advanced functions overview for the SAN Volume Controller Console” on page 137

You can perform “advanced” functions using the SAN Volume Controller Console.

## Increasing the size of your cluster using the SAN Volume Controller Console

To increase the size of a cluster, complete these tasks.

To increase the size of your cluster you need to add nodes in pairs to a new I/O group. Your existing cluster may have become a bottleneck and so you wish to increase throughput by adding more nodes to the cluster.

Perform the following steps to increase the size of your cluster:

1. Add a node to increase the size of your cluster and repeat this procedure for the second node.
2. If you wish to balance the load between the existing I/O groups and the new I/O groups, migrate your VDIs to new I/O groups. Repeat this procedure for all VDIs you want to assign to the new I/O group.

### Related tasks

“Adding a node to increase the size of your cluster” on page 140

Ensure that you are familiar with adding a node to increase the size of your cluster.

“Migrating a VDisk to a new I/O group” on page 141

You can migrate a VDisk to a new I/O group to manually balance the workload across the nodes in the cluster. You may end up with a pair of nodes that are overworked and another pair that are under-worked. Follow this procedure to migrate a single VDisk to a new I/O group. Repeat for other VDIs as required.

### Related information

“Advanced functions overview for the SAN Volume Controller Console” on page 137

You can perform “advanced” functions using the SAN Volume Controller Console.

## Adding a node to increase the size of your cluster

Ensure that you are familiar with adding a node to increase the size of your cluster.

Perform the following steps to add a node to increase the size of your cluster:

1. Click **Work with I/O groups** to determine which I/O group you wish to add the nodes to.
2. Look for the first I/O group listed that has a node count of 0. Write down the I/O group name. You will need it in the following step.
- 3.

**Attention:** If you are re-adding a node to the SAN, ensure that you are adding the node to the same I/O group that it was removed from. Failure to do this can result in data corruption. Use the information that was recorded when the node was originally added to the cluster. If you do not have access to this information, call IBM Service to add the node back into the cluster without corrupting the data.

If you are adding the node into the cluster for the first time, record the following information:

- Card Nodeseial number
- Node serial number
- WWNN
- All WWPNS
- I/O group that contains the node

This can avoid a possible data corruption exposure if the node must be removed from and re-added to the cluster.

**Note:** This warning is also displayed on the SAN Volume Controller Console panel when adding the node.

4. Select the node from the list of available candidate nodes and select the I/O group from the list.
5. Optionally enter a node name for this node.
6. Verify that the node is online by refreshing the **Work with Nodes** panel. You may need to close the panel and reopen it for the refresh to take effect.
7. You may also need to modify the configuration of your disk controller systems. If your disk controller system uses a mapping technique to present its RAID arrays or partitions to the cluster, you will need to modify the port groups that belong to the cluster because the WWNN and WWPNS of the node have changed.

### Related tasks

“Increasing the size of your cluster using the SAN Volume Controller Console” on page 139

To increase the size of a cluster, complete these tasks.

“Displaying node properties using the SAN Volume Controller Console” on page 125

You can display the node properties using the Viewing general details panel.

### Related reference

“Configuring and servicing storage subsystems” on page 253

Follow the guidelines and procedures outlined in this section to make the most of the performance available from your storage subsystems and to avoid potential I/O problems.

#### **Related information**

“Scenario: typical usage for the SAN Volume Controller Console” on page 118

This hypothetical example describes a scenario for configuring the SAN Volume Controller using the SAN Volume Controller Console.

### **Migrating a VDisk to a new I/O group**

You can migrate a VDisk to a new I/O group to manually balance the workload across the nodes in the cluster. You may end up with a pair of nodes that are overworked and another pair that are under-worked. Follow this procedure to migrate a single VDisk to a new I/O group. Repeat for other VDIs as required.

**Attention:** This is a disruptive procedure, access to the VDisk will be lost while you follow this procedure. Under no circumstances should VDIs be moved to an offline I/O group. You must ensure the I/O group is online before moving the VDIs to avoid data loss scenarios.

Perform the following steps to migrate a single VDisk:

1. Quiesce all I/O operations for the VDisk. You may need to determine the hosts that are using this VDisk.
2. Before migrating the VDisk, it is essential that for each vpath presented by the VDisk you intend to move, the SDD configuration is updated to remove the vpaths in question. Failure to do this may result in data corruption. See *IBM TotalStorage Subsystem Device Driver: User's Guide* for details about how to dynamically re-configure SDD for the given host operating system.
3. Any FlashCopy mappings or Remote Copy relationships that use this VDisk should be stopped and deleted. To check if the VDisk is part of a mapping or relationship, perform the following steps:
  - a. Click **Work with VDIs**.
  - b. Click on the VDisk name to view the details.
  - c. Look for the **FlashCopy ID** and **Remote Copy ID** fields. If these are not blank then the VDisk is part of a mapping or relationship.
4. Migrate the VDisk by selecting the VDisk from the **Work with VDIs** panel and selecting the **Modify** task. Change only the I/O group to the new I/O group name.
5. It is now necessary to follow the SDD procedure to discover the new vpaths and to check that each vpath is now present with the correct number of paths. See the *IBM TotalStorage Subsystem Device Driver: User's Guide* for details on how to dynamically re-configure SDD for the given host operating system.

#### **Related tasks**

“Increasing the size of your cluster using the SAN Volume Controller Console” on page 139

To increase the size of a cluster, complete these tasks.

“Determining the relationship between VDIs and MDIs using the SAN Volume Controller Console” on page 138

Ensure that you understand the relationship between VDIs and MDIs using the SAN Volume Controller Console.

#### **Related reference**

“Advanced function Remote Copy overview” on page 152

For detailed information about how to perform advanced FlashCopy and Remote Copy functions, go to the following Web site: [www.ibm.com/redbooks](http://www.ibm.com/redbooks)

## Replacing a faulty node with a spare node using the SAN Volume Controller Console

To replace a faulty node in the cluster using the SAN Volume Controller Console, complete these tasks.

Before you attempt to replace a faulty node with a spare node you must ensure that:

- SAN Volume Controller version 1.1.1 or higher is installed on the cluster and on the spare node. The code levels are available from the node and cluster VPD. You can also issue the **svcinfo lsnode** or **svcinfo lscluster** commands to determine the SAN Volume Controller version.
- You know the name of the cluster that contains the faulty node.
- A spare node is installed in the same rack as the cluster that contains the faulty node.
- You make a record of the last five characters of the original worldwide node name (WWNN) of the spare node. You will need this information, if and when, you want to stop using this node as a spare node. In that case, you might prefer to use it as a normal node that can be assigned to any cluster.

Perform the following steps to display and record the WWNN of the spare node:

1. Display the node status on the front panel display of the node. See the *IBM TotalStorage SAN Volume Controller: Service Guide* for more information.
2. With the node status displayed on the front panel, press and hold the **Down** button; press and release the **Select** button; release the **Down** button. WWNN is displayed on line-1 of the display; line-2 of the display contains the last five characters of the WWNN.
3. Record the WWNN in a safe place. It will be needed if you want to stop using the spare node.

If a node fails, the cluster continues to operate with degraded performance, until the faulty node is repaired. If the repair operation is likely to take an unacceptable amount of time, it might be useful to replace the faulty node with a spare node. However, the appropriate procedures must be followed and precautions must be taken, in order not to interrupt I/O operations and to avoid compromising the integrity of your data. The procedures outlined in this topic involve changing the worldwide node name (WWNN) of a SAN Volume Controller. These procedures must be followed with care in order to avoid duplicate WWPNs which can cause data corruption.

Be aware that by performing these procedures the following changes will be made to your configuration:

### Front Panel ID

This number will change. It is the number that is printed on the front of the node and used to select the node that is to be added to a cluster.

### Node Name

This number might change. If you do not specify a name, the SAN Volume Controller assigns a default name when adding a node to a cluster. The SAN Volume Controller creates a new name each time a node is added to a cluster. If you choose to assign your own names then you need to type in

the node name on the Adding a node to a cluster panel. If you are using scripts to perform management tasks on the cluster and those scripts use the node name, then by assigning the original name to a replacement node, you avoid the need to make changes to the scripts.

### Node ID

This ID will change. A new node ID is assigned each time a node is added to a cluster; the node name remains the same following service activity on the cluster. You can use the node ID or the node name to perform management tasks on the cluster. However, if you are using scripts to perform those tasks, use the node name rather than the node ID.

### Worldwide Node Name

This name will change. The WWNN is used to uniquely identify the node and the fibre-channel ports. The WWNN of the spare node will change to that of the faulty node. The node replacement procedures must be followed exactly to avoid any duplication of WWNNs.

### Worldwide Port Names

These names do not change. WWPNS are derived from the WWNN that is written to the spare (replacement) node as part of this procedure. For example, let's say the WWNN for a node is 50050768010000F6. The four WWPNS for this node would be derived as follows:

WWNN	50050768010000F6
WWNN displayed on front panel	000F6
WWPN Port 1	50050768014000F6
WWPN Port 2	50050768013000F6
WWPN Port 3	50050768011000F6
WWPN Port 4	50050768012000F6

Perform the following steps to replace a faulty node in the cluster:

1. Verify the name and ID of the node that you wish to replace.

Perform the following steps to verify the name and ID:

- a. Make sure that the SAN Volume Controller Console application is running on the cluster that contains the faulty node.
- b. Click **Work with Nodes** in the portfolio.
- c. Click **Nodes**.

If the node is faulty, it will be shown as offline. Ensure the partner node in the I/O group is online.

- 1) If the other node in the I/O group is offline, start Directed Maintenance Procedures to determine the fault.
- 2) If you have been directed here by the DMPs, and subsequently the partner node in the I/O group has failed, see the procedure for Recovering from offline VDisks.

If you are replacing the node for other reasons, determine the node you wish to replace and again ensure the partner node in the I/O group is online.

- 1) If the partner node is offline, you will lose access to the VDisks that belong to this I/O group if you continue. Start the Directed Maintenance Procedures and fix the other node before proceeding.

2. Find and record the following information about the faulty node:

- a. Node name
- b. I/O group name
- c. Last five characters of the WWNN

- d. Front panel ID
- e. Uninterruptible power supply serial number
- a. To find and record the node name and I/O group name, click **Work with Nodes** in the portfolio.
- b. Click **Nodes**.  
The faulty node will be offline.
- c. Record the following information about the faulty node:
  - Node name
  - I/O group name
- d. To find and record the last five characters of the WWNN, click on the name of the offline node.
- e. Click the **General** tab.
- f. Record the last five characters of the WWNN.
- g. To find and record the front panel ID, click the **Vital Product Data** tab.
- h. Find the front-panel-assembly section of the vital product data (VPD).
- i. Record the front panel ID.
- j. To find and record the uninterruptible power supply serial number, click the **Vital Product Data** tab.
- k. Find the uninterruptible power supply section of the VPD.
- l. Record the uninterruptible power supply serial number.
3. Obtain the ID of the faulty node. Disconnect all four fibre-channel cables from the node.

**Important:** Do not plug the fibre-channel cables into the spare node until spare node has been configured with the WWNN from the faulty node.

4. Connect the power and signal cables from the spare node to the uninterruptible power supply that has the serial number that you noted in step 5l.

**Note:** The signal cable can be plugged into any vacant position on the top row of serial connectors on the uninterruptible power supply. If no spare serial connectors are available on the uninterruptible power supply, disconnect the cables from the faulty SAN Volume Controller.

5. Power-on the spare node.
6. Display the node status on the service panel. See the *IBM TotalStorage SAN Volume Controller: Service Guide* for more information.

7. Change the WWNN of the spare node.

Perform the following steps to change the WWNN of the spare node so that it matches the WWNN of the faulty node:

- a. With the node status displayed on the front panel, press and hold the **Down** button; press and release the **Select** button; release the **Down** button. WWNN is displayed on line-1 of the display; line-2 of the display contains the last five characters of the WWNN.
- b. With the WWNN displayed on the service panel, press and hold the **Down** button, press and release the **Select** button, release the **Down** button. This switches the display into edit mode. Change the displayed number to match the WWNN recorded in step 5f.

**Note:** To edit the displayed number use the **Up** and **Down** buttons to increase or decrease the numbers displayed. Use the **left** and **right**

buttons to move between fields. When the five characters match the number recorded in step 1, press the select button twice to accept the number.

8. Connect the four fibre-channel cables that were disconnected from the faulty node to the spare node.
9. Remove the faulty node from the cluster using the SAN Volume Controller Console.

**Remember:** Record the following information:

- Node serial number
- WWNN
- All WWPNs
- I/O group that contains the node

This can avoid a possible data corruption exposure when the node is re-added to the cluster.

10. Add the spare node to the cluster using the SAN Volume Controller Console.
11. Use the Subsystem Device Driver (SDD) management tool on the host systems to verify that all paths are now online. See the *IBM TotalStorage Subsystem Device Driver: User's Guide* for more information.

**Attention:** When the faulty node is repaired do not connect the fibre-channel cables to it. Connecting the cables might cause data corruption.

12. Repair the faulty node.
13. If you want to use the repaired node as a spare node, perform the following steps:

- a. Display the node status on the front panel display of the node. See the *IBM TotalStorage SAN Volume Controller: Service Guide* for more information.
- b. With the node status displayed on the front panel, press and hold the **Down** button; press and release the **Select** button; release the **Down** button. WWNN is displayed on line-1 of the display; line-2 of the display contains the last five characters of the WWNN.
- c. With the WWNN displayed on the service panel, press and hold the **Down** button, press and release the **Select** button, release the **Down** button. This switches the display into edit mode. Change the displayed number to 00000.

**Note:** To edit the displayed number use the **Up** and **Down** buttons to increase or decrease the numbers displayed. Use the **left** and **right** buttons to move between fields.

This SAN Volume Controller can now be used as a spare node.

**Attention:** Never connect a SAN Volume Controller with a WWNN of 00000 to the cluster. If this SAN Volume Controller is no longer required as a spare and is to be used for normal attachment to a cluster you must first use the procedure described in the "Prerequisites" to change the WWNN to the number you recorded when a spare was created. Using any other number might cause data corruption.

### Related tasks

"Deleting a node from a cluster" on page 155

A node might need to be deleted from a cluster if the node has failed and is being replaced with a new node or if the repair that has been performed has caused that node to be unrecognizable by the cluster.

“Launching the SAN Volume Controller Console” on page 114  
You can launch the SAN Volume Controller from the Viewing Clusters panel.  
“Replacing a faulty node in the cluster using the CLI” on page 206  
You can replace a faulty node in the cluster using the command-line interface (CLI).

#### **Related information**

“Advanced functions overview for the SAN Volume Controller Console” on page 137  
You can perform “advanced” functions using the SAN Volume Controller Console.

## **Recovering from offline VDIs after a node or an I/O group failed**

If you have lost both nodes in an I/O group and have therefore, lost access to all the VDIs that are associated with the I/O group, then you must perform one of the following procedures to regain access to your VDIs. Depending on the failure type, you may have lost data that was cached for these VDIs, therefore, they have gone offline.

**Data loss scenario 1** One node in an I/O group failed and failover started on the second node. During this time, the second node in the I/O group fails before the data in the write cache has been written to disk. The first node is successfully repaired but its cache data is stale, therefore, it cannot be used. The second node is repaired or replaced and has lost its hard-end data, therefore, the node has no way of recognizing that it is part of the cluster.

Perform the following steps to recover from an offline VDI:

1. Recover the node and include it back into the cluster.
2. Move all the offline VDIs to the recovery I/O group.
3. Move all the offline VDIs back to their original I/O group.

**Data loss scenario 2** Both nodes in the I/O group have failed and have been repaired. The nodes have lost their hard-end data, therefore, the nodes have no way of recognizing that they are part of the cluster.

1. Move all the offline VDIs to the recovery I/O group
2. Move both recovered nodes back into the cluster
3. Move all the offline VDIs back to their original I/O group.

#### **Related tasks**

“Recovering a node and including it back into the cluster” on page 147  
After a node or an I/O group fails, you can use the following procedure to recover a node and include it back into the cluster.

“Moving offline VDIs to the recovery I/O group” on page 148  
After a node or an I/O group fails, you can use the following procedure to move offline VDIs to the recovery I/O group.

“Moving offline VDIs to their original I/O group” on page 148  
After a node or an I/O group fails, you can use the following procedure to move offline VDIs to their original I/O group.

#### **Related information**

“Advanced functions overview for the SAN Volume Controller Console” on page 137  
You can perform “advanced” functions using the SAN Volume Controller Console.



## Recovering a node and including it back into the cluster

After a node or an I/O group fails, you can use the following procedure to recover a node and include it back into the cluster.

Perform the following steps to recover a node and include it back into the cluster:

1. Verify that the node is offline by viewing the **Work with Nodes** panel.
2. Remove the old instance of the offline node from the cluster by selecting the node and selecting the **Delete Node** task.
3. Verify that the node can be seen on the fabric.
4. If the nodes are repaired by replacing the front panel module or a node is repaired by replacing it with another node, then the WWNN for the node will change. In this case, the following additional steps are required:
  - a. At the end of the recovery process it will be necessary to follow the SDD procedure to discover the new paths and to check that each vpath is now presenting the correct number of paths. For information about adding paths to existing vpaths, see the *IBM TotalStorage Subsystem Device Driver: User's Guide*.
  - b. You may also need to modify the configuration of your disk controller systems. If your disk controller system uses a mapping technique to present its RAID arrays or partitions to the cluster you will need to modify the port groups that belong to the cluster because the WWNN or WWPN's of the node have changed.

**Attention:** If more than one I/O group is affected, ensure that you are adding the node to the same I/O group that it was removed from. Failure to do this can result in data corruption. Use the information that was recorded when the node was originally added to the cluster. This can avoid a possible data corruption exposure if the node must be removed from and re-added to the cluster. If you do not have access to this information, call IBM Service to add the node back into the cluster without corrupting the data.

**Attention:** If you are adding the node into the cluster for the first time, record the following information:

- Node serial number
- WWNN
- All WWPNs
- I/O group that contains the node

**Note:** This warning is also displayed on the SAN Volume Controller Console panel when adding the node.

5. Add the node back into the cluster by selecting the **Add Node** task from the **Work with Nodes** panel. Select the node from the list of candidate nodes and select the I/O group from the list. Optionally enter a node name for this node.
6. Verify that the node is online by refreshing the **Work with Nodes** panel.

**Note:** You may need to close the panel and reopen it for the refresh to take effect.

### Related tasks

“Recovering from offline VDisks after a node or an I/O group failed” on page 146  
If you have lost both nodes in an I/O group and have therefore, lost access to all the VDisks that are associated with the I/O group, then you must perform one

of the following procedures to regain access to your VDIs. Depending on the failure type, you may have lost data that was cached for these VDIs, therefore, they have gone offline.

### **Moving offline VDIs to the recovery I/O group**

After a node or an I/O group fails, you can use the following procedure to move offline VDIs to the recovery I/O group.

Perform the following steps to move offline VDIs to the recovery I/O group:

1. List all VDIs that are offline and that belong to the I/O group in question by selecting **Work with VDIs** from the portfolio. In the filter panel, enter the <iogrname> in the I/O group filter box and select offline as the status.
2. For each VDI returned, select the VDI and select the **Modify** task. In the modify panel, only change the I/O group to **Recovery I/O group**. You may be asked to confirm and force the move, select to force the move.

#### **Related tasks**

“Recovering from offline VDIs after a node or an I/O group failed” on page 146  
If you have lost both nodes in an I/O group and have therefore, lost access to all the VDIs that are associated with the I/O group, then you must perform one of the following procedures to regain access to your VDIs. Depending on the failure type, you may have lost data that was cached for these VDIs, therefore, they have gone offline.

### **Moving offline VDIs to their original I/O group**

After a node or an I/O group fails, you can use the following procedure to move offline VDIs to their original I/O group.

**Attention:** Under no circumstances should VDIs be moved to an offline I/O group. Ensure the I/O group is online before moving the VDIs back to avoid any further data loss.

Perform the following steps to move offline VDIs to their original I/O group:

1. For each VDI, select the VDI and select the **Modify** task. In the modify panel, only modify the I/O group back to the original <iogrname>.
2. Verify that the VDIs are now online by closing the Work with VDIs panel and opening it again. This time, in the filter panel, only enter the <iogrname> in the I/O group filter box. The VDIs should all be online.

#### **Related tasks**

“Recovering from offline VDIs after a node or an I/O group failed” on page 146  
If you have lost both nodes in an I/O group and have therefore, lost access to all the VDIs that are associated with the I/O group, then you must perform one of the following procedures to regain access to your VDIs. Depending on the failure type, you may have lost data that was cached for these VDIs, therefore, they have gone offline.

## **Replacing an HBA in a host using the SAN Volume Controller Console**

It is sometimes necessary to replace the HBA that connects the host to the SAN, at this time you must notify the SAN Volume Controller of the new WWPN's that this HBA contains.

Ensure your switch is zoned correctly.

This procedure describes how to notify the SAN Volume Controller of a change to a defined host object.

1. Locate the host object that corresponds with the host in which you have replaced the HBA. Click **Work with Hosts** from the portfolio. Select the host object and select the **Add Ports** task.
2. Add the new ports to the existing host object. Select the candidate WWPNs from the list and click **Add**. Complete the task by clicking **OK**.
3. Remove the old ports from the host object. Select the host object and select the **Delete Ports** task. Select the WWPNs you wish to remove (the ones that correspond with the old HBA that was replaced). Click **Add** to add them to the list of WWPNs to be deleted. Complete the task by clicking **OK**.
4. Any mappings that exist between the host object and VDIsks will automatically be applied to the new WWPNs. Therefore, the host should see the VDIsks as the same SCSI LUNs as before. See *IBM TotalStorage Subsystem Device Driver: User's Guide* for adding paths to existing vpaths.

#### **Related reference**

“Configuring and servicing storage subsystems” on page 253

Follow the guidelines and procedures outlined in this section to make the most of the performance available from your storage subsystems and to avoid potential I/O problems.

## **Deleting hosts**

You can delete a host object using the Deleting hosts panel.

A deletion fails if there are any VDisk-to-host mappings for the host. If you attempt to delete the host and it fails due to the existence of VDisk mappings, then you are presented with the opportunity to perform a forced delete, which will delete VDisk mappings before deleting the host.

Perform the following steps to delete a host object:

1. Click **Work with Virtual Disks** in the portfolio.
2. Click **Hosts** in the portfolio. The Filtering Hosts panel is displayed.
3. Specify the filter criteria that you want to use. Click **OK**. The Hosts panel is displayed.
4. Select the host that you want to delete and select **Delete Host** from the list.
5. Click **Go**.

When you delete a host object, all active ports are added to the **Available Ports** list.

#### **Related concepts**

“Host objects” on page 29

A host system is an open-systems computer that is connected to the switch through a fibre-channel interface.

## **Shrinking virtual disks**

You can shrink a virtual disk (VDisk) from the Shrinking VDIsks panel.

VDIsks can be reduced in size should it be required. However, if the VDisk contains data that is being used, **under no circumstances should you attempt to shrink a VDisk without first backing up your data**. The SAN Volume Controller arbitrarily reduces the capacity of the VDisk by removing a partial, one or more extents from those allocated to the VDisk. You cannot control which extents are removed and so you cannot guarantee that it is unused space that is removed.

**Attention:** This feature should *only* be used to make a target or auxiliary VDisk the same size as the source or master VDisk when creating FlashCopy mappings or Remote Copy relationships. You should also ensure that the target VDisk is not mapped to any hosts prior to performing this operation.

Perform the following steps to shrink a VDisk:

1. Validate that the VDisk is not mapped to any host objects. If the VDisk is mapped, data is displayed.
2. You can determine the exact capacity of the source or master VDisk. Issue the following command:

```
svcinfolsvdisk -bytes <vdiskname>
```

**Note:** It is not possible to determine the exact size using the SAN Volume Controller Console.

3. Click **Work with Virtual Disks** from the portfolio.
4. Click **Virtual Disks** from the portfolio. The Filtering Virtual Disks panel is displayed.
5. Specify the filter criteria that you want to use. Click **OK**. The Virtual Disks panel is displayed.
6. Select the VDisk you want to shrink and select **Shrink a VDisk** from the list. Click **Go**. The Shrinking VDisks panel is displayed.

#### **Related concepts**

“Virtual disks” on page 26

A *VDisk* is a logical disk that the cluster presents to the storage area network (SAN).

## **Migrating virtual disks**

You can migrate a virtual disk (VDisk) from one MDisk group to another from the Migrating VDisks panel.

The SAN Volume Controller provides various data migration features. These can be used to move the placement of data both within MDisk groups and between MDisk groups. These features can be used concurrent with I/O operations. There are two ways in which you can migrate data:

1. Migrating data (extents) from one MDisk to another (within the same MDisk group). This can be used to remove hot or overutilized MDisks. This can only be performed using the CLI.
2. Migrating VDisks from one MDisk group to another. This can be used to remove hot MDisk groups, for example, you can reduce the utilization of a group of MDisks.

You can determine the usage of particular MDisks by gathering I/O statistics about MDisks and VDisks. Once you have gathered this data, you can analyze it to determine which VDisks or MDisks are hot. This procedure then takes you through migrating VDisks from one MDisk group to another.

When a migrate command is issued, a check is made to ensure that the destination of the migrate has enough free extents to satisfy the command. If it does, the command proceeds, but will take some time to complete. During this time, it is possible for the free destination extents to be consumed by another process, for example, by creating a new VDisk in the destination MDisk group or by starting more migrate commands. In this scenario, when all the destination extents have

been allocated the migration commands suspend and an error is logged (error id 020005). There are two methods for recovering from this situation:

1. Add additional MDisks to the target MDisk group. This will provide additional extents in the group and will allow the migrations to be restarted (by marking the error as fixed).
2. Migrate one or more VDIsks that are already created from the MDisk group to another group. This will free up extents in the group and allow the original migrations to be restarted (again by marking the error as fixed).

Perform the following steps to migrate VDIsks between MDisk groups:

1. Isolate any VDIsks that are overutilized. You can determine this by requesting an I/O statistics dump and analyzing the output. To start I/O statistics gathering, select **Manage Cluster** from the portfolio, then select the **Start statistics collection** task. Enter 15 minutes for the interval and click **OK**. This will generate a new I/O statistics dump file approximately every 15 minutes. Wait for at least 15 minutes before proceeding to the next step.
2. Select **Service and Maintenance** from the portfolio and then select the **List dumps** task.
3. Click on the **I/O Statistics logs** link in the panel displayed. This will list the I/O statistics files that have been generated. These are prefixed with *m* and *Nm* for MDisk statistics and *v* for VDisk statistics. Click on one of the filenames to view the contents.
4. Analyze the dumps to determine which VDIsks are hot. It may be helpful to also determine which MDIsks are being heavily utilized as you can spread the data they contain more evenly across all the MDIsks in the group.
5. Stop the statistics collection again by selecting **Manage Cluster** from the portfolio and then select **Stop statistics collection** task. Once you have analyzed the I/O statistics data, you can determine which VDIsks are hot. You also need to determine which MDisk group you wish to move this VDisk to. Either create a new MDisk group or determine an existing group that is not yet over utilized. You can do this by checking the I/O statistics files generated above and ensuring that the MDIsks or VDIsks in the target MDisk group are less utilized than the source group.
  - a. Click **Work with Virtual Disks** from the portfolio.
  - b. Click **Virtual Disks** from the portfolio. The Filtering Virtual Disks panel is displayed.
  - c. Specify the filter criteria that you want to use. Click **OK**. The Virtual Disks panel is displayed.
  - d. Select the VDisk you want to migrate and select **Migrate a VDisk** from the list. Click **Go**. The Migrating VDIsks panel is displayed.

#### **Related concepts**

“Virtual disks” on page 26

A *VDisk* is a logical disk that the cluster presents to the storage area network (SAN).

## **Creating image-mode virtual disks**

The SAN Volume Controller enables you to import storage that contains existing data and continue to use this storage but make use of the advanced functions, such as, Copy Services, data migration, and the cache. These disks are known as image mode virtual disks.

Make sure you are aware of the following before converting your virtual disks:

1. Managed disks that contain existing data cannot be differentiated from managed disks that are blank. Therefore, it is vital that you control the introduction of these disks to the cluster. It is recommended that you introduce these disks one at a time. For example, map a single LUN from your RAID controller to the cluster and refresh the view of managed disks. The newly detected disk is displayed.
2. *Do not* add a managed disk that contains existing data to a managed disk group manually. If you do, the data will be lost. When you create an image mode virtual disk from this managed disk, it will be automatically added to the managed disk group. However, it will be added in such a way that the cluster can control how it is added to ensure the data is not lost.

Go to the following Web site for more information:

<http://www-1.ibm.com/servers/storage/support/virtual/2145.html>

1. Map a single RAID array or LUN from your RAID controller to the cluster. You can do this either through a switch zoning or a RAID controller based on your host mappings.
2. Re-scan the list of managed disks from the SAN Volume Controller Console. Click **Work with Managed Disks** → **Managed Disks**. You can then filter through the unmanaged mode disks.  
Optionally, if the new managed disk is not listed you may need to run a fabric level discovery. From the SAN Volume Controller Console, select **Work with Managed Disks** and choose **Task discovery**. After a few minutes, refresh the view of managed disks and the new managed disk should be displayed.
3. Convert the managed disk into an image mode virtual disk. In the SAN Volume Controller Console, select the specific managed disk and choose task **Create VDisk in Image Mode**. This will bring up the create image mode virtual disk wizard. You can select the managed disk group to add this managed disk to, and the I/O group that will provide the up-stream data path for the virtual disk.
4. Map the new virtual disk to the hosts that were previously using the data that the MDisk contains. In the SAN Volume Controller Console, select **Work with Virtual Disks** → **Virtual Disks**. On the Filtering Virtual Disks (VDisks) panel, enter the filter criteria or click **Bypass filter**. On the Viewing Virtual Disks panel, choose **Map a VDisk to a host**, and click **Go**. If you wish to convert this virtual disk or managed disk to actually virtualize the storage, you can transform the image mode virtual disk into a striped virtual disk by migrating the data on the managed disk to other managed disks in the same group. This procedure can only be performed using the command-line interface (CLI).

## Advanced function Remote Copy overview

For detailed information about how to perform advanced FlashCopy and Remote Copy functions, go to the following Web site: [www.ibm.com/redbooks](http://www.ibm.com/redbooks)

### Related reference

“Valid combinations of FlashCopy and Remote Copy functions” on page 376  
The following table outlines the combinations of FlashCopy and Remote Copy functions that are valid for a single virtual disk (VDisk).

## Advanced function cluster overview

Ensure that you are familiar with the advanced function cluster overview using the SAN Volume Controller Console.

### Related tasks

“Analyzing the error log”

You can analyze the error log from the Analyze Error Log panel.

“Changing the language settings” on page 154

To change the language settings, complete these steps.

“Configuring error notification settings” on page 154

You can configure the error notification settings for the cluster from the Set Error Notification Settings panel.

“Deleting a node from a cluster” on page 155

A node might need to be deleted from a cluster if the node has failed and is being replaced with a new node or if the repair that has been performed has caused that node to be unrecognizable by the cluster.

“Enabling the cluster maintenance procedure using the SAN Volume Controller Console” on page 157

To enable the cluster maintenance procedure using the SAN Volume Controller Console, complete these steps.

“Listing and saving log and dump files” on page 157

You can list the log and dump files on the configuration node on the List Dumps panel.

“Renaming a cluster” on page 158

You can rename a cluster from the Renaming Cluster panel.

“Maintaining cluster passwords using the” on page 158

To maintain cluster passwords using the SAN Volume Controller Console, complete these steps.

“Modifying Internet Protocol (IP) addresses” on page 165

You can display and change the IP addresses associated with the cluster from the Modify IP Addresses panel.

“Shutting down a cluster or node” on page 165

You can shut down a cluster from the Shutting Down cluster panel.

“Viewing the feature log” on page 167

You can view the feature log for the cluster from the View Feature Log panel.

“Viewing feature settings and log” on page 167

You can view the feature settings in the Viewing Feature Log panel.

#### **Related information**

“Managing SSH keys” on page 159

You can manage SSH keys from the SAN Volume Controller Console.

### **Analyzing the error log**

You can analyze the error log from the Analyze Error Log panel.

Perform the following steps to analyze the error log:

1. Click **Service and Maintenance** in the portfolio.
2. Click **Analyze Error Log** in the portfolio. The Error log analysis panel is displayed. The Error log analysis panel enables you to analyze the cluster error log. You can display the whole log or filter the log so that only errors, events, or unfixed errors are displayed. In addition, you can request the table to be sorted either by error priority or by time. For error priority, the most serious errors are the lowest-numbered errors. They are, therefore, displayed first in the table. For time, either the oldest or the latest entry can be displayed first in the table. You can also select how many error log entries are to be displayed on each page of the table. The default is set to 10, and the maximum number of error logs that can be displayed on each page is 100.

3. After selecting the options, click **Process** to display the filtered error log in the table. The Analyze error log continued panel is displayed. Forward and Backward scroll buttons are displayed, depending on the existing page number and the total number of pages that are in the table. If the table contains more than two pages of entries, a **Go to** input area is displayed in the table footer. This input area enables you to skip to a particular page number.  
If you click on the sequence number of a particular table record, more information about that error log entry is displayed. If the record is an error (instead of an event), you can change the fixed or unfixed status of the record; that is, you can mark an unfixed error as fixed or a fixed error an unfixed.
4. Click **Clear log** to erase the whole cluster error log.

**Note:** If you click **Clear log**, this will *not* fix the existing errors.

**Related reference**

“Advanced function cluster overview” on page 152

Ensure that you are familiar with the advanced function cluster overview using the SAN Volume Controller Console.

## Changing the language settings

To change the language settings, complete these steps.

Perform the following steps to change the language settings:

1. Click **View Clusters** and select a cluster that you want to change the language setting for.
2. Click **Launch SAN Volume Controller application**.
3. Click **Manage Cluster**.
4. Click **General Properties**. From this panel you can change the locale setting to the appropriate language.

**Related reference**

“Advanced function cluster overview” on page 152

Ensure that you are familiar with the advanced function cluster overview using the SAN Volume Controller Console.

## Configuring error notification settings

You can configure the error notification settings for the cluster from the Set Error Notification Settings panel.

Perform the following steps to configure the error notification settings:

1. Click **Service and Maintenance** in the portfolio.
2. Click **Error settings** to display the existing error notification settings and to change them. The Modify Error Notification Settings panel is displayed. The Modify Error Notification Settings panel enables you to update your error notification settings. You can select whether the cluster raises an SNMP trap for entries that are added to the cluster error or event log. Three levels of notification are possible:
  - a. **None** No error or status changes will be sent.
  - b. **Hardware\_only** You will be notified of errors, but you will not be notified of status changes.
  - c. **All** You will be notified of all errors and status changes.
3. Click **Modify settings** to update the settings.

**Related reference**



“Advanced function cluster overview” on page 152

Ensure that you are familiar with the advanced function cluster overview using the SAN Volume Controller Console.

### Deleting a node from a cluster

A node might need to be deleted from a cluster if the node has failed and is being replaced with a new node or if the repair that has been performed has caused that node to be unrecognizable by the cluster.

**Attention:** Before deleting or removing a node from the cluster you should quiesce all I/O operations that are destined for this node. Failure to do so may result in failed I/O operations being reported to your host operating systems.

**Attention:** If you are deleting or removing a single node, and the other node in the I/O group is online, be aware that the cache on the partner node will go into write-through mode and that you are exposed to a single point of failure should the partner node fail. Proceed to step 3 in the following procedure.

**Attention:** If you are deleting or removing a node, and this is the last node in the I/O group, you will lose access to all VDIs served by this I/O group. Ensure that all VDIs are not being accessed or do not contain data that you wish to continue to access, or ensure that they have been migrated to a different (online) I/O group.

1. Begin by determining the VDIs that are still assigned to this I/O group:
  - a. Determine the VDIs in question by requesting a filtered view of VDIs where the filter attribute is the I/O group in question.
  - b. Once you have a list of VDIs, determine the hosts that they are mapped to by following the procedure called, Determining the hosts that a VDI is mapped to.
  - c. Once you have determined the hosts and are sure that you do not wish to maintain access to these VDIs proceed to 3 on page 156.
  - d. If you determine that some or all of the VDIs assigned to this I/O group do contain data that you wish to continue to access, you should follow the procedure called, Migrating a VDI to a new I/O group.
2. Before performing the SDD path removal procedure described in 3 on page 156 you should power off the node that you intend to remove, unless this is the last node in the cluster. This ensures that SDD does not re-discover the paths that are manually removed before you issue the delete node request.

**Note:**

- a. If the node you are removing is the configuration node, it might take a minute or more before you can perform the delete node request. You must wait for the configuration node failover to occur.
- b. If the node you are removing is the last node in the cluster, the SAN Volume Controller Console might seem to hang for up to 3 minutes because you have removed the last access point to the cluster.

**Attention:** Deleting the configuration node or shutting down the configuration node may result in the SSH command hanging. If this happens, you should either wait for the SSH command to timeout or kill the command and ping the cluster IP address until it responds. At this point the failover has completed and you can start issuing commands again.

**Note:** If you power back on the node that has been removed and it is still connected to the same fabric or zone it will attempt to re-join the cluster.

At this point the cluster will tell the node to remove itself from the cluster and the node will become a candidate for addition to this cluster or another cluster. If you are adding this node back into the cluster, ensure that you add it back to the same I/O group that it was previously a member of. Failure to do so may result in data corruption.

3. Before deleting the node, it is essential that for each vpath presented by the VDisks you intend to remove, the SDD configuration is updated to remove the vpaths in question. Failure to do this may result in data corruption. See the *IBM TotalStorage Subsystem Device Driver: User's Guide* for details about how to dynamically reconfigure SDD for the given host operating system.
4. Proceed to 1.

For example, if the disk drive or the software on the node has been replaced, that node will no longer be known by the cluster. You can delete or remove a node from the cluster with the Deleting a Node from Cluster panel.

1. Click **Work with Nodes** from the portfolio.
2. Click **Nodes** from the portfolio. The Nodes panel is displayed.

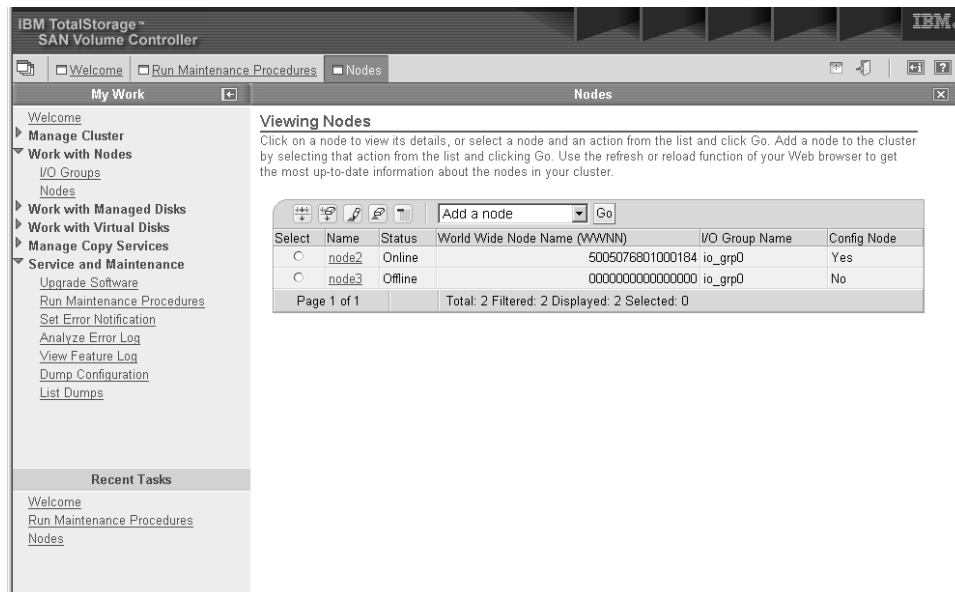

Figure 43. SAN Volume Controller Console nodes panel

3. Select the node you want to delete and Select **Delete a node** from the list. Click **Go**. The Deleting a Node from a Cluster panel is displayed.

#### Related concepts

“Clusters” on page 11

All configuration and service is performed at the cluster level.

“Nodes and clusters” on page 11

A SAN Volume Controller node is a single processing unit, which provides virtualization, cache, and copy services for the SAN.

#### Related tasks

“Determining the host that a VDisk is mapped to” on page 202

You can determine the host that a VDisk is mapped to using the command-line interface (CLI).

“Migrating a VDisk to a new I/O group” on page 141

You can migrate a VDisk to a new I/O group to manually balance the workload

across the nodes in the cluster. You may end up with a pair of nodes that are overworked and another pair that are under-worked. Follow this procedure to migrate a single VDisk to a new I/O group. Repeat for other VDIs as required.

#### **Related reference**

“Advanced function cluster overview” on page 152

Ensure that you are familiar with the advanced function cluster overview using the SAN Volume Controller Console.

## **Enabling the cluster maintenance procedure using the SAN Volume Controller Console**

To enable the cluster maintenance procedure using the SAN Volume Controller Console, complete these steps.

Perform the following steps to enable the maintenance procedure:

1. Click **Service and Maintenance** from the portfolio.
2. Click **Run Maintenance Procedures** to start the online maintenance procedures. The Maintenance procedures panel is displayed. A popup window is also displayed, requesting you to enter the user name and password for the SAN Volume Controller cluster. The Maintenance procedures window enables you to run the maintenance procedure on the cluster.
3. Click **Start Analysis** to analyze the cluster error log. A table of unfixed errors is displayed. The errors are sorted so that the most serious errors (those with the lowest error code) are listed first. The Maintenance panel is displayed. If you click the error code of a particular error log entry, you are guided through a series of actions that help you to estimate the state of the cluster and determine if the error was an isolated event or if a component has failed. If a component has failed, it might be necessary to exchange that component. Where necessary, images of the failing component are displayed. If a repair is performed successfully, the state of an error record in the error log changes from **unfixed error** to **fixed error**.

#### **Related reference**

“Advanced function cluster overview” on page 152

Ensure that you are familiar with the advanced function cluster overview using the SAN Volume Controller Console.

## **Listing and saving log and dump files**

You can list the log and dump files on the configuration node on the List Dumps panel.

Dump data can be saved on any node in the cluster. When you use this procedure to display dump data only, the dump files on the configuration node will be displayed. An option is provided on the dumps menu to display data from other nodes. If you choose to display or save data from another node, that data will first be copied to the configuration node.

Perform the following steps to list the various types of log and dump files:

1. Click **Service and Maintenance** from the portfolio.
2. Click **List Dumps** from the portfolio. The List Dumps panel displays. The List dumps (other nodes) continued panel displays the number of log files or dumps of a particular type that are available on the cluster. If there is more than one node in the cluster (as is usual), the **Check other nodes** button is displayed. If you click this button, the log files and dumps for all nodes that are part of the cluster is displayed. Dumps and logs on all nodes in the cluster can be deleted or copied to the node.

If you click on one of the file types, all the files of that type are listed in a table.

**Note:** For error logs and software dumps, the file names include the node name and time and date as part of the file name.

You can copy the files to a local workstation by right-clicking on the filename and using the **Save target as** (Netscape) or **Save file as** (Internet Explorer) option from the Web browser.

The file types that the **List dumps** option supports are:

- Error logs
- Configuration logs
- I/O statistic logs
- I/O trace logs
- Feature logs
- Software dumps

Follow the instructions in the right pane to display and save the dumps that you need.

The software dump files contain dumps of the SAN Volume Controller memory. Your service representative might ask for these dumps to debug problems. The software dumps are large files (approximately 300 MB). Consider copying these files to your host using secure copy methods.

#### **Related reference**

“Advanced function cluster overview” on page 152

Ensure that you are familiar with the advanced function cluster overview using the SAN Volume Controller Console.

## **Renaming a cluster**

You can rename a cluster from the Renaming Cluster panel.

Perform the following steps to rename a cluster:

1. Click **Clusters** from the portfolio. The Viewing Clusters panel is displayed.
2. Select the cluster that you want to rename and select **Rename a cluster** from the list. Click **Go**. The Renaming Cluster panel is displayed.
3. Complete the Renaming Cluster panel.

The cluster is renamed to the name that you selected.

#### **Related concepts**

“Clusters” on page 11

All configuration and service is performed at the cluster level.

#### **Related reference**

“Advanced function cluster overview” on page 152

Ensure that you are familiar with the advanced function cluster overview using the SAN Volume Controller Console.

## **Maintaining cluster passwords using the**

To maintain cluster passwords using the SAN Volume Controller Console, complete these steps.

Perform the following steps to maintain passwords:

1. Click **Manage Cluster** from the portfolio.
2. Click **Maintain Passwords** to modify the admin or service passwords that control access to the create cluster wizard. The Maintain passwords panel is

displayed. The Maintain passwords window enables you to update the passwords that control access to the Web application for admin and service users. Passwords must be typed twice to allow verification. Passwords can consist of A - Z, a - z, 0 - 9, and underscore.

3. Type your admin or service user password and then click **Maintain Passwords** to change the password. If the admin password is changed, a password prompt is displayed and you must re-authenticate the password by entering the new admin password in the password prompt. Make a careful note of the admin password, because without it, you cannot access the cluster through the SAN Volume Controller Console.

#### **Related reference**

“Advanced function cluster overview” on page 152

Ensure that you are familiar with the advanced function cluster overview using the SAN Volume Controller Console.

## **Managing SSH keys**

You can manage SSH keys from the SAN Volume Controller Console.

#### **Related tasks**

“Adding SSH keys for hosts other than the master console”

Use these step-by-step instructions for adding SSH keys on hosts other than the master console.

“Adding subsequent SSH public keys to the SAN Volume Controller” on page 160

During the cluster creation wizard, you will have added an SSH key to the cluster that allows the master console (where the SAN Volume Controller is running) to access the cluster. If you wish to add more SSH keys, that is, grant SSH access to other servers you need to follow the procedure below.

“Replace the client SSH private key known to the SAN Volume Controller software” on page 161

To replace the client SSH private key known to the SAN Volume Controller software, complete these steps.

“Resetting the SSH fingerprint” on page 164

You can reset the SSH fingerprint for a cluster that is managed by the SAN Volume Controller Console for your configuration by using the Resetting the SSH Fingerprint panel.

#### **Related reference**

“Advanced function cluster overview” on page 152

Ensure that you are familiar with the advanced function cluster overview using the SAN Volume Controller Console.

“Replacing the SSH key pair” on page 162

You can replace the SSH key pair using the SAN Volume Controller Console.

#### **Related information**

“Resetting a refused SSH key” on page 163

You can reset a refused SSH key relationship between the SAN Volume Controller Console and the SAN Volume Controller cluster.

### ***Adding SSH keys for hosts other than the master console:***

Use these step-by-step instructions for adding SSH keys on hosts other than the master console.

1. Generate the public private key pair on each host that you want to use the SAN Volume Controller command line interface. See the information that came with your SSH client for specific details about using the key generation program that comes with your SSH client.
2. Copy the public keys from each of these hosts to the master console.
3. Secure copy these public keys from the master console to the cluster.  
Repeat for each public key copied onto the master console in 2.

#### Related information

“Managing SSH keys” on page 159

You can manage SSH keys from the SAN Volume Controller Console.

#### **Adding subsequent SSH public keys to the SAN Volume Controller:**

During the cluster creation wizard, you will have added an SSH key to the cluster that allows the master console (where the SAN Volume Controller is running) to access the cluster. If you wish to add more SSH keys, that is, grant SSH access to other servers you need to follow the procedure below.

1. Click **Clusters** in the Portfolio.
2. Click the cluster whose SSH keys you want to maintain.
3. Select Maintain SSH Keys in the drop-down list and click **Go**. The SSH Key Maintenance panel is displayed.

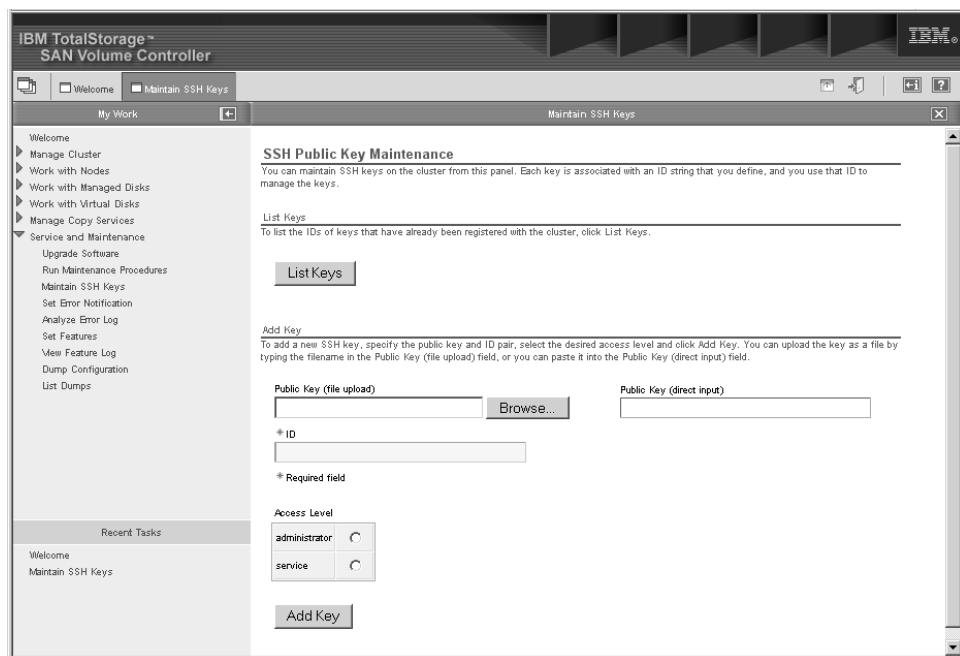

4. Click the **Maintain SSH Keys** option. The window appears to enable you to enter the client SSH public key information to be stored on the cluster. At the SSH key maintenance window, perform the following steps:
  - a. If you are adding the SSH client key for the master console, click **Browse** and locate the public key you generated earlier. If you are adding an SSH client key for another system, either click **Browse** and locate the public key or cut and paste the public key into the direct input field.
  - b. Click **Administrator**.

- c. Type a name of your choice in the **ID** field that uniquely identifies the key to the cluster.
- d. Click **Add Key**.
- e. Click **Maintain SSH Keys**.

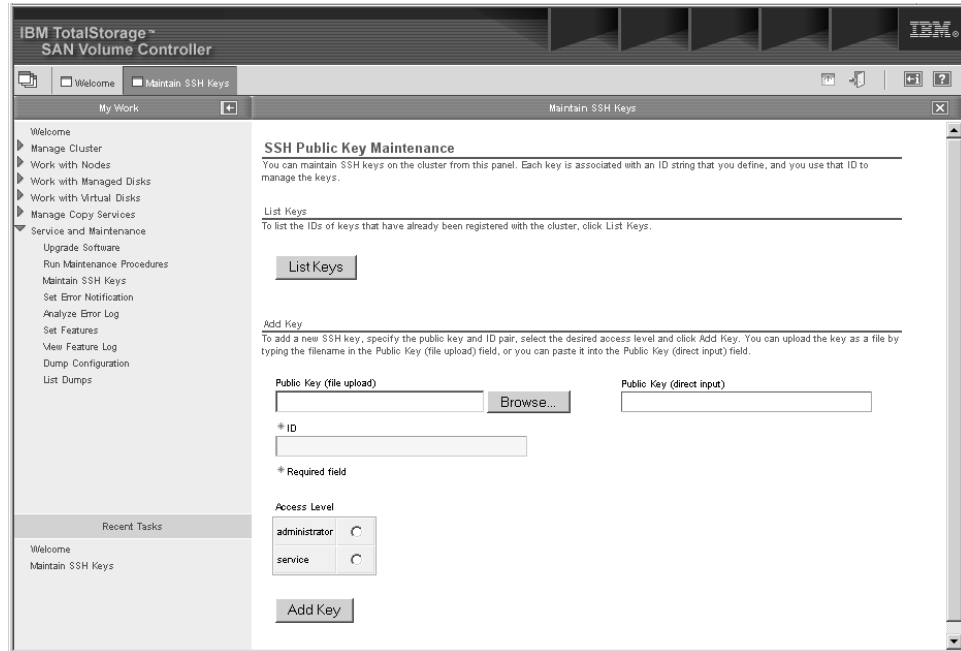

- f. Click the **Show IDs** button to see all key IDs loaded on the SAN Volume Controller.

After the initial configuration of the cluster has been performed using the SAN Volume Controller and at least one SSH client key has been added the remainder of the configuration may either be performed using the SAN Volume Controller or the Command Line Interface (CLI).

#### **Related information**

“Managing SSH keys” on page 159

You can manage SSH keys from the SAN Volume Controller Console.

“Secure Shell (SSH)” on page 78

Secure Shell (SSH) is a client-server network application.

#### ***Replace the client SSH private key known to the SAN Volume Controller software:***

To replace the client SSH private key known to the SAN Volume Controller software, complete these steps.

**Attention:** If you have successfully contacted other SAN Volume Controller clusters, you will break that connectivity if you replace the client SSH private key known to the SAN Volume Controller software.

Perform the following steps to replace the client SSH private key:

1. Sign off the SAN Volume Controller Console.
2. Using the Windows Services facility, stop the IBM CIM Object Manager. Perform the following:

- a. Click **Start -> Settings -> Control Panel**.
  - b. Double-click **Administrative Tools**.
  - c. Double-click **Services**.
  - d. Select **IBM CIM Object Manager** in the list of services, right click, and select **Stop**.
  - e. Leave the Services panel open.
3. Copy the client SSH private key into the appropriate SAN Volume Controller Console directory. Perform the following:
    - a. Open a command prompt window by clicking **Start -> Run**.
    - b. Type `cmd.exe` in the **Open** field.
    - c. Click **OK**.
  4. Type the following command:

```
copy <filename> C:\program files\IBM\svconconsole\cimom\icat.ppk
```

where *<filename>* is the path and file name of the client SSH private key.

5. Restart the IBM CIM Object Manager. Select **IBM CIM Object Manager** in the list of services, right click and select **Start**.
6. Log on to the SAN Volume Controller Console.
7. Click **Clusters** in the portfolio.
8. Check the status of the cluster.

#### **Related information**

“Managing SSH keys” on page 159

You can manage SSH keys from the SAN Volume Controller Console.

#### ***Replacing the SSH key pair:***

You can replace the SSH key pair using the SAN Volume Controller Console.

- If you change the SSH keys that will be used by the master console to communicate with the SAN Volume Controller Console, you will have to store the client SSH private key in the SAN Volume Controller Console software and then store the client SSH public key on the SAN Volume Controller cluster.
- If you change the IP address of your SAN Volume Controller cluster after you have added the cluster to SAN Volume Controller Console, the SAN Volume Controller Console will not be aware of the existence of the cluster.

The procedure to correct this is to remove the cluster from the SAN Volume Controller Console and add it back again. To correct these scenarios, perform the following steps:

1. Start the SAN Volume Controller Console by clicking on the desktop icon or by using your Web browser to go to

```
http://<IPAddress>:9080/ica
```

where *<IPAddress>* is the IP address of the master console. The Sign on window is displayed. This might take a few moments to open.

2. Enter the user ID `superuser` and the password `passwd`. The Welcome window is displayed.
3. Click **Clusters** from the portfolio.
4. Check the **Select** box for the cluster for which you wish to replace the key.
5. Click **Remove a cluster** in the selection box.



6. Click **Go**.
7. Click **Clusters** from the portfolio.
8. Select **Add a cluster** from the drop down box.
9. Click **Go**.
10. Input the IP address of the cluster.
11. Do not check the **Create (Initialize Cluster)** box.
12. Click **OK**.
13. Enter the user name and password. When you see the pop-up window, enter the network password and click **OK**.
14. Add the SSH client public key to the SAN Volume Controller cluster:
  - a. Click **Browse...** for the key file to upload and locate the public key or input the key in the **Key (direct input)** field.
  - b. Type an ID in the **ID** field, which uniquely identifies the key to the cluster.
  - c. Select the **administrator** radio button.
  - d. Click **Add Key**.
  - e. Click **Clusters** from the portfolio to check the status of the cluster. If the cluster status remains **SSH Key Refused**, you do not have a good key pair. You can reset the SAN Volume Controller Console private SSH key. However, if you have successfully contacted other clusters, you will break that connectivity.

#### **Related information**

“Managing SSH keys” on page 159

You can manage SSH keys from the SAN Volume Controller Console.

#### ***Resetting a refused SSH key:***

You can reset a refused SSH key relationship between the SAN Volume Controller Console and the SAN Volume Controller cluster.

#### **Overview**

The communication between the SAN Volume Controller Console software and the SAN Volume Controller cluster is through the Secure Shell (SSH) protocol. In this protocol, the SAN Volume Controller Console software acts as the SSH client and the SAN Volume Controller cluster acts as the SSH host server.

As an SSH client, the SAN Volume Controller Console must use an SSH2 RSA key pair composed of a public key and a private key which are coordinated at key generation time. The SSH client public key is stored on each SAN Volume Controller cluster with which the SAN Volume Controller Console communicates. The SSH client private key is known to the SAN Volume Controller Console software by being stored in a specific directory with a specific name. If the SSH protocol detects the key pair is mismatched, the SSH communication fail.

The SAN Volume Controller Console externalizes the status of a mismatched or invalid SAN Volume Controller Console client key pair in the **Availability Status** column of the Cluster panel.

Because the client SSH key pair must be coordinated across two systems, you might have to take one or more actions to reset the pair of keys. Perform one or more of the following steps to reset the refused client SSH key pair:

- Replace the client SSH public key on the SAN Volume Controller cluster

- Replace the client SSH private key known to the SAN Volume Controller software

**Related information**

“Managing SSH keys” on page 159

You can manage SSH keys from the SAN Volume Controller Console.

***Resetting the SSH fingerprint:***

You can reset the SSH fingerprint for a cluster that is managed by the SAN Volume Controller Console for your configuration by using the Resetting the SSH Fingerprint panel.

You must have superuser administrator authority to perform the following procedure.

If you have changed the name of the master console, you must also change the master console host name in the IBM WebSphere Application Server files.

The communication between the SAN Volume Controller Console and the cluster is through the Secure Shell (SSH) protocol. In this protocol, the SAN Volume Controller Console acts as the SSH client and the cluster acts as the SSH host server. The SSH protocol requires that credentials are exchanged when communication between the SSH client and server begins. The SSH client places the accepted SSH host server fingerprint in cache. Any change to the SSH server fingerprint in future exchanges results in a challenge to the end user to accept the new fingerprint. When a new code load is performed on the cluster, new SSH server keys can be produced which result in the SSH client flagging the SSH host fingerprint as changed and, therefore, no longer valid.

The SAN Volume Controller Console displays the status of the cluster SSH server key in the **Availability Status** column of the Viewing Clusters panel.

Perform the following steps to reset the SSH fingerprint:

1. Click **Clusters** in the portfolio. The View Clusters panel is displayed.  
**Attention:** Select a cluster that has an availability status of *Invalid SSH Fingerprint*. In some cases this availability status results from a software upgrade that disrupts normal user operations. In the case of a disruptive software upgrade, follow the procedure for Recovering from a Disruptive Software Upgrade.
2. Select the cluster that you want to reset the SSH fingerprint for and select **Reset SSH Fingerprint** from the list. Click **Go**. The Resetting the SSH Fingerprint panel is displayed.
3. Select **OK** when prompted with the message, CMMVC3201W.

Availability status is changed to OK.

**Related concepts**

“Clusters” on page 11

All configuration and service is performed at the cluster level.

**Related tasks**

“Configuring the master console host name” on page 84

If you have changed the host name of the master console, you must modify some of the IBM WebSphere Application Server files that are used by the SAN Volume Controller Console and Tivoli SAN Manager.

**Related information**

“Managing SSH keys” on page 159

You can manage SSH keys from the SAN Volume Controller Console.

## Modifying Internet Protocol (IP) addresses

You can display and change the IP addresses associated with the cluster from the Modify IP Addresses panel.

Perform the following steps to change the IP addresses:

1. Click **Manage Cluster** in the portfolio.
2. Click **Modify IP Addresses** to check or change the IP address settings for the cluster. The **Modify IP Addresses** panel is displayed. The Modify IP Addresses panel displays the existing value for the following IP Addresses and enables you to change the settings:
  - a. Cluster IP address
  - b. Service IP address (used when the node is not part of the cluster)
  - c. Subnet mask
  - d. Gateway

Fill in all four fields for the IP address that you want to change. Leave the IP address fields blank if you do not want to change them.

Click **Modify settings** to perform the IP address update. When you specify a new cluster IP address, the existing communication with the cluster is broken. You must use the new cluster IP address to reestablish your browser connection. A new SSL certificate is generated by the cluster (to show the new IP address). This new certificate is displayed when the Web browser first connects to the cluster.

### Related concepts

“Clusters” on page 11

All configuration and service is performed at the cluster level.

### Related reference

“Advanced function cluster overview” on page 152

Ensure that you are familiar with the advanced function cluster overview using the SAN Volume Controller Console.

## Shutting down a cluster or node

You can shut down a cluster from the Shutting Down cluster panel.

If all input power to a SAN Volume Controller cluster is to be removed, for example, if the machine room power is to be shutdown for maintenance, you must shut down the cluster before the power is removed. If you do not shut down the cluster before turning off input power to the uninterruptible power supply, the SAN Volume Controllers will detect the loss of power and continue to run on battery power until all data held in memory is saved to the internal disk drive. This will increase the time required to make the cluster operational when input power is restored and will severely increase the time required to recover from an unexpected loss of power that might occur before the uninterruptible power supply batteries have fully recharged.

When input power is restored to the uninterruptible power supplies they will start to recharge but the SAN Volume Controllers will not permit any I/O activity to be performed to the virtual disks until the uninterruptible power supply is charged enough to enable all the data on the SAN Volume Controller nodes to be saved in the event of an unexpected power loss. This might take as long as three hours. Shutting down the cluster prior to removing input power to the uninterruptible power

supply units will prevent the battery power being drained and will make it possible for I/O activity to be resumed as soon as input power is restored.

Before shutting down a node or the cluster you should quiesce all I/O operations that are destined for this node or cluster. Failure to do so may result in failed I/O operations being reported to your host operating systems.

**Attention:** If you are shutting down the entire cluster, you will lose access to all VDisks being provided by this cluster. Shutting down the cluster will also shut down all nodes. This shutdown will cause the hardened data to be dumped to the internal hard drive.

**Attention:** Ensure that you have stopped all FlashCopy, Remote Copy and data migration operations before you attempt a node or cluster shutdown. Also ensure that all asynchronous deletion operations have completed prior to a shutdown operation.

Begin the process of quiescing all I/O to the cluster by stopping the applications on your hosts that are using the VDisks provided by the cluster.

1. If you are unsure which hosts are using the VDisks provided by the cluster, follow the procedure called, Determining the hosts that a VDisk is mapped to.
2. Repeat the previous step for all VDisks.

A cluster or node can be shutdown by stopping I/O activity and either pressing the power buttons on the front of each node or by issuing a shutdown command to the cluster.

**Attention:** You must press and hold the power button for one second to shutdown the node.

When input power is restored it will be necessary to press the power button on the uninterruptible power supply units before pressing the power buttons on the SAN Volume Controllers.

Perform the following steps to shut down a cluster:

1. Click **Manage Clusters** in the portfolio.
2. Click **Shut down Clusters** in the portfolio. The Shutting Down Clusters panel is displayed. To shut down a node, click **Shut down Nodes**. The Shutting Down Nodes panel is displayed.

**Related concepts**

“Clusters” on page 11

All configuration and service is performed at the cluster level.

**Related tasks**

“Determining the host that a VDisk is mapped to” on page 202

You can determine the host that a VDisk is mapped to using the command-line interface (CLI).

**Related reference**

“Advanced function cluster overview” on page 152

Ensure that you are familiar with the advanced function cluster overview using the SAN Volume Controller Console.

## Viewing the feature log

You can view the feature log for the cluster from the View Feature Log panel.

Perform the following steps to view that feature log for the cluster:

1. Click **Service and Maintenance**.
2. Click **View Feature Log**. The View Feature Log panel is displayed.

### Related reference

“Advanced function cluster overview” on page 152

Ensure that you are familiar with the advanced function cluster overview using the SAN Volume Controller Console.

## Reviewing and setting the cluster features using the SAN Volume Controller Console

You can set up the cluster features using the SAN Volume Controller Console.

Perform the following steps to set up the cluster features:

1. Ensure that you have the correct license. The license will show you whether you are permitted to use flash copy or remote copy. It will also show how much virtualization you are permitted to use.
2. From the Creating a Cluster wizard, click **Featurization settings** to set-up or modify your featurization attributes. The Featurization settings window is displayed.
3. The allowed setting for each of the parameters is specified in your license. The following features can be set:
  - a. Enable the FlashCopy or Remote copy options if they are licensed.
  - b. Enter the virtualization limit as specified in the licence. A zero value is not allowed for this field.
  - c. Click **Set features**. A featurization screen is displayed.

## Viewing feature settings and log

You can view the feature settings in the Viewing Feature Log panel.

Perform the following steps to view the feature settings:

1. Click **Service and Maintenance** from the portfolio.
2. To view the feature settings, click **Set Features** from the portfolio. To view the feature log, click **View Feature Log**.

### Related concepts

“Clusters” on page 11

All configuration and service is performed at the cluster level.

### Related reference

“Advanced function cluster overview” on page 152

Ensure that you are familiar with the advanced function cluster overview using the SAN Volume Controller Console.



---

## Chapter 4. Command-Line Interface

This part provides detailed information about using the command-line interface.

### Related information

“Using the Command-Line Interface (CLI)”

The SAN Volume Controller cluster Command-Line Interface (CLI) is a collection of commands you can use to manage the SAN Volume Controller.

“Scenario: typical usage for the command-line interface” on page 179

The main focus of the following example is to provide storage to your host system using the command-line interface (CLI).

“Advanced functions with the CLI” on page 200

Ensure that you are familiar with the advanced functions that you can perform using the command-line interface (CLI).

---

## Using the Command-Line Interface (CLI)

The SAN Volume Controller cluster Command-Line Interface (CLI) is a collection of commands you can use to manage the SAN Volume Controller.

### Overview

The vehicle for these commands is the secure shell (SSH) connection between the SSH client software on the host system and the SSH server on the SAN Volume Controller cluster.

Before using the CLI, you must have performed the following initial steps to create and configure a cluster:

- Create a cluster from the front panel
- Complete the creation of a cluster using the SAN Volume Controller Console
- Perform the initial configuration of the cluster using the SAN Volume Controller

In order to use the CLI from a client system you must:

- Install and setup SSH client software on each system which you are going to issue command lines from.
- Generate an SSH key pair on each SSH client.
- Store the SSH public key for each SSH client on to the SAN Volume Controller using the SAN Volume Controller Console.

**Note:** After the first SSH public key has been stored further SSH public keys may be added using either the SAN Volume Controller Console or the CLI.

The functions that can be performed with the IBM TotalStorage SAN Volume Controller Command-Line Interface (CLI) are:

- Setup of the cluster, its nodes, and the I/O groups (or node pairs). This function includes diagnostics and error log analysis of the cluster.
- Setup and maintenance of managed disks and managed disk groups.
- Setup and maintenance of client public SSH keys on the cluster.
- Setup and maintenance of virtual disks.
- Setup of logical host objects.
- Mapping of virtual disks to hosts.

- Navigation from managed hosts to virtual disk groups and to managed disks, and the reverse direction up the chain.
- Setup and trigger of Copy Services:
  - FlashCopy and FlashCopy Consistency groups
  - Synchronous Remote Copy and Remote Copy Consistency groups

Cisco MDS 9000 also provides a CLI that allows you to perform management and service functions. Two commands, create cluster and upgrade, are only available through the Cisco MDS 9000 CLI. Other Cisco MDS CLI commands allow you to reset a node, put a node in service mode, get cluster information, get node information, recover a cluster, and change a WWNN or WWPN. Refer to Cisco MDS 9000 publication for further information.

#### **Related tasks**

“Preparing the SSH client system to issue command-line interface commands” on page 171

In order to issue command-line interface (CLI) commands to the cluster from a host, you must prepare the Secure Shell (SSH) client on the host so that the host will be accepted by the SSH server on the cluster and allowed to connect.

“Preparing the SSH client on an AIX host” on page 172

When using AIX hosts, SSH logins are authenticated on the SAN Volume Controller cluster using the RSA based authentication supported in the OpenSSH client available for AIX.

“Issuing CLI commands from a PuTTY SSH Client system” on page 174

You can issue CLI commands from a PuTTY SSH Client system.

“Configuring the cluster using the CLI” on page 177

You can configure the cluster using the command-line interface (CLI).

“Setting the cluster time using the CLI” on page 178

This task provides step-by-step instructions for setting the cluster time using the command-line interface.

“Reviewing and setting the cluster features using the CLI” on page 178

You can set up the cluster features using the command-line interface (CLI).

“Displaying cluster properties using the CLI” on page 179

You can display cluster properties using the command-line interface (CLI).

“Maintaining passwords using the CLI” on page 179

You can maintain passwords using the command-line interface (CLI).

#### **Related reference**

“Preparing the SSH client system overview”

Before you can issue CLI commands from the host to the cluster, you must prepare the SSH client system.

#### **Related information**

Chapter 4, “Command-Line Interface,” on page 169

“Running the PuTTY and plink utilities” on page 174

Ensure that you are familiar with how to run the PuTTY and plink utilities.

## **Preparing the SSH client system overview**

Before you can issue CLI commands from the host to the cluster, you must prepare the SSH client system.



### **Windows operating systems:**

The master console is a Windows 2000 system that is equipped with the PuTTY Secure Shell (SSH) client software.

You can install the PuTTY SSH client software on another Windows host using the PuTTY Installation program `putty-0.53b-installer.exe` which is in the `SSHClient\PuTTY` directory of the SAN Volume Controller Console CD-ROM. Or, you can download PuTTY from the following Web site:  
<http://www.chiark.greenend.org.uk/~sgtatham/putty/>

The following Web site offers SSH client alternatives for Windows:  
<http://www.openssh.com/windows.html>

Cygwin software has an option to install an OpenSSH client. You can download cygwin from the following Web site: <http://www.cygwin.com/>

### **AIX operating systems:**

For AIX® 5L Power 5.1 and 5.2, you can get OpenSSH from the Bonus Packs and you will also need its prerequisite, OpenSSL, from the AIX toolbox for Linux applications for Power Systems. For AIX 4.3.3, you can get the software from the AIX toolbox for Linux applications.

You can also get the AIX installation images from IBM DeveloperWorks at the following Web site: <http://oss.software.ibm.com/developerworks/projects/openssh>

### **Linux operating systems:**

OpenSSH is installed by default on most Linux distributions. If it is not installed on your system, consult your installation media or visit the following Web site:  
<http://www.openssh.org/portable.html>

OpenSSH is able to run on a wide variety of additional operating systems. For more information visit the following Web site: <http://www.openssh.org/portable.html>

#### **Related information**

“Using the Command-Line Interface (CLI)” on page 169

The SAN Volume Controller cluster Command-Line Interface (CLI) is a collection of commands you can use to manage the SAN Volume Controller.

## **Preparing the SSH client system to issue command-line interface commands**

In order to issue command-line interface (CLI) commands to the cluster from a host, you must prepare the Secure Shell (SSH) client on the host so that the host will be accepted by the SSH server on the cluster and allowed to connect.

If you wish to use a host which requires a different type of SSH client, for example OpenSSH, follow the instructions for that software.

Perform the following steps to enable your host to issue CLI commands:

1. For the master console and Windows hosts:
  - a. Generate a SSH key pair using the **PuTTY** key generator.
  - b. Store the SSH clients public key on the cluster (using a browser pointing to the SAN Volume Controller Console).

- c. Configure the PuTTY session for the command-line interface
2. For other types of hosts:
  - a. Follow the instructions specific to the SSH client to generate an SSH key pair.
  - b. Store the SSH clients public key on the cluster (using a browser pointing to the SAN Volume Controller Console or the Command Line Interface from an already established host).
  - c. Follow the instructions specific to the SSH client to establish an SSH connection to the SAN Volume Controller cluster.
3. For other types of hosts, follow the instructions specific to the SSH client.

#### **Related tasks**

“Adding SSH keys for hosts other than the master console” on page 159  
Use these step-by-step instructions for adding SSH keys on hosts other than the master console.

“Configuring the PuTTY session for the command-line interface” on page 82  
If you are preparing to run the CLI from the master console, you will need to configure the PuTTY session on the SSH client system.

“Storing SSH keys in the SAN Volume Controller Console” on page 82  
When the keys that are used to communicate with the SAN Volume Controller are changed, you must store a copy of the new private key in the SAN Volume Controller Console.

“Generating an SSH key pair using the SSH client called PuTTY” on page 81  
These are step-by-step instructions for generating SSH keys on the PuTTY SSH client system.

#### **Related information**

“Using the Command-Line Interface (CLI)” on page 169  
The SAN Volume Controller cluster Command-Line Interface (CLI) is a collection of commands you can use to manage the SAN Volume Controller.

“Secure Shell (SSH)” on page 78  
Secure Shell (SSH) is a client-server network application.

## **Preparing the SSH client on an AIX host**

When using AIX hosts, SSH logins are authenticated on the SAN Volume Controller cluster using the RSA based authentication supported in the OpenSSH client available for AIX.

This scheme is based on public-key cryptography, using a scheme known commonly as RSA. In this system (as in similar OpenSSH systems on other host types) the encryption and decryption is done using separate keys. This means it is not possible to derive the decryption key from the encryption key. Initially, the user creates a public/private key pair for authentication purposes. The server (which is the SAN Volume Controller cluster in this case) knows the public key, and only the user (or the AIX host) knows the private key. Physical possession of the public key allows access to the cluster, so this must be kept in a protected place (typically in the `/.ssh` directory on the AIX host, with restricted access permissions).

The SAN Volume Controller cluster uses the following mechanism to establish that the AIX host is to be trusted, for example, that the AIX host possesses the private key.

When you log in from the AIX host to the SAN Volume Controller cluster, the SSH program on the SAN Volume Controller cluster tells the AIX host which key pair it

would like to use for authentication. The AIX server checks if this key is permitted, and if so, sends the user (actually the SSH program running on behalf of the user) a challenge, a random number, encrypted by the user's public key. The challenge can only be decrypted using the proper private key. The user's client (for example, the AIX host) then decrypts the challenge using the private key, proving that he/she knows the private key but without disclosing it to the server (for example, the SAN Volume Controller cluster) or to anyone who might be intercepting the transmissions between the AIX host and the SAN Volume Controller cluster.

The main steps in setting up a RSA key pair on the AIX host and the SAN Volume Controller cluster are as follows (detailed instructions are given in subsequent paragraphs):

1. Create an RSA key pair by running the `ssh-keygen` program on the AIX host.
2. Store the private key from this key pair on the AIX host, in the `/.ssh` directory.
3. Place the public key on the SAN Volume Controller cluster and associate this key with an 'admin' or 'service' type user.

The main steps in setting up a RSA key pair on the AIX host and the SAN Volume Controller cluster are as follows (detailed instructions are given in subsequent paragraphs):

1. Create an RSA key pair by running the `ssh-keygen` program on the AIX host.
2. Store the private key from this key pair on the AIX host, in the `/.ssh` directory.
3. Place the public key on the SAN Volume Controller cluster and associate this key with an 'admin' or 'service' type user.

At this point, you may then use the 'ssh' or 'scp' utilities on the AIX host to establish an SSH session with the SAN Volume Controller cluster or to perform Secure Copy operations between the AIX host and the SAN Volume Controller cluster.

Perform the following steps to set up a RSA key pair on the AIX host and the SAN Volume Controller cluster:

1. Create an RSA key pair by running the `ssh-keygen` program on the AIX host. This is best done in the `$HOME/.ssh` directory. This process will generate two user named files. Suppose the user selects the name 'key', then the files will be named 'key' and 'key.pub'.
2. Store the private key from this key pair on the AIX host, in the '`$HOME/.ssh` directory', in the '`$HOME.ssh/identity` file'. In the simplest case, this means replacing the contents of the 'identity' file with the contents of the 'key' file. If multiple keys are to be used however, then all of these keys must appear in the 'identity' file. This step places the private key on the host.
3. Move the public key, 'key.pub' to the master console of the SAN Volume Controller cluster of interest. Typically this might be done with `ftp` however the master console may have `ftp` disabled for security reasons, in which case an alternative method would be required (for example, a secure copy between the application host and the master console ). Then, using the SAN Volume Controller Console, and the SAN Volume Controller Web interface, select the 'Maintain SSH Keys' panel, and transfer the `key.pub` to the cluster. Select an access level of 'administrator' or 'service' as appropriate. In this example, we will assume the key was associated with an administrative ID and that the cluster IP name is 'mycluster'. This step places the public key on the cluster.
4. You can now access the cluster from the AIX host, using SSH commands similar to the following:

```
ssh admin@mycluster
ssh admin@mycluster svcinfo lsnode
```

Refer to your clients documentation for SSH on your host system for more host specific details of this procedure.

#### **Related tasks**

“Adding SSH keys for hosts other than the master console” on page 159  
Use these step-by-step instructions for adding SSH keys on hosts other than the master console.

“Configuring the PuTTY session for the command-line interface” on page 82  
If you are preparing to run the CLI from the master console, you will need to configure the PuTTY session on the SSH client system.

“Storing SSH keys in the SAN Volume Controller Console” on page 82  
When the keys that are used to communicate with the SAN Volume Controller are changed, you must store a copy of the new private key in the SAN Volume Controller Console.

“Generating an SSH key pair using the SSH client called PuTTY” on page 81  
These are step-by-step instructions for generating SSH keys on the PuTTY SSH client system.

#### **Related information**

“Using the Command-Line Interface (CLI)” on page 169  
The SAN Volume Controller cluster Command-Line Interface (CLI) is a collection of commands you can use to manage the SAN Volume Controller.

“Secure Shell (SSH)” on page 78  
Secure Shell (SSH) is a client-server network application.

## **Issuing CLI commands from a PuTTY SSH Client system**

You can issue CLI commands from a PuTTY SSH Client system.

Perform the following steps to issue CLI commands:

1. Open a Command Prompt to open the SSH connection to issue the CLI commands.
2. Make the PuTTY executables available by performing the following:
  - a. Change directory into the PuTTY executable directory. For example, on the master console, type the following:

```
C:\Support Utils\putty
```

```
C:\Program Files\Putty
```

- b. Set the path environment variable to include the PuTTY executable directory. For example, type the following:

```
Set path=c:\Support Utils\putty;%path%
```

3. Use the PuTTY plink utility to connect to the SSH server on the cluster.

#### **Related information**

“Using the Command-Line Interface (CLI)” on page 169  
The SAN Volume Controller cluster Command-Line Interface (CLI) is a collection of commands you can use to manage the SAN Volume Controller.

## **Running the PuTTY and plink utilities**

Ensure that you are familiar with how to run the PuTTY and plink utilities.

All CLI commands are run in an SSH session. You can run the commands in either of the following modes:

- An interactive prompt mode
- A single line command mode, which is entered one time to include all parameters

### Interactive mode

For interactive mode, you use the PuTTY executable to open the SSH restricted shell. Type the following:

```
C:\support utils\putty>putty admin@<svconsoleip>
```

If you were to issue the **svcinfolsshkeys** command, which lists the SSH client public keys that are stored on the SAN Volume Controller cluster, the following output is displayed:

```
IBM_2145:admin>svcinfolsshkeys -user all -delim :
id:userid:key identifier
1:admin:smith
2:admin:jones
```

Type **exit** and press **Enter** to escape the interactive mode command.

The SSH protocol specifies that the first access to a new host server will result in a *challenge* to the SSH user to accept the SSH server public key. Because this is the first time that you connect to an SSH server, the server is not included in the SSH client list of known hosts. Therefore, there is a fingerprint challenge, which asks you do you accept the responsibility of connecting with this host. If you type *y*, the host fingerprint and IP address is saved by the SSH client. For PuTTY, you answer by typing *y* to accept this host fingerprint. This information is stored in the registry for the user name which is logged onto Windows.

The following is an example of the host fingerprint challenge when running in interactive mode:

```
C:\Program Files\IBM\svconsole\cimom>plink admin@9.43.225.208
The server's host key is not cached in the registry. You
have no guarantee that the server is the computer you
think it is.
The server's key fingerprint is:
ssh-rsa 1024 e4:c9:51:50:61:63:e9:cd:73:2a:60:6b:f0:be:25:bf
If you trust this host, enter "y" to add the key to
PuTTY's cache and carry on connecting.
If you want to carry on connecting just once, without
adding the key to the cache, enter "n".
If you do not trust this host, press Return to abandon the
connection.
Store key in cache? (y/n) y
Using username "admin".
Authenticating with public key "imported-openssh-key"
IBM_2145:admin>
```

## Single line command

For single line command mode, you can type the following all on one command line:

```
C:\Program Files\IBM\svconconsole\cimom>
plink admin@9.43.225.208 svcinfo lssshkeys
-user all -delim :
Authenticating with public key "imported-openssh-key"
/bin/lis: id:userid:key identifier
1:admin:smith
2:admin:jones
```

```
C:\Program Files\IBM\svconconsole\cimom>
```

The SSH protocol specifies that the first access to a new host server will result in a *challenge* to the SSH user to accept the SSH server public key. Because this is the first time that you connect to an SSH server, the server is not included in the SSH client list of known hosts. Therefore, there is a fingerprint challenge, which asks you do you accept the responsibility of connecting with this host. If you type *y*, the host fingerprint and IP address is saved by the SSH client. For PuTTY, you answer by typing *y* to accept this host fingerprint. This information is stored in the registry for the user name which is logged onto Windows.

The following is an example of the host fingerprint challenge when running in single line command mode:

```
C:\Program Files\IBM\svconconsole\cimom>
plink admin@9.43.225.208 svcinfo lssshkeys
-user all -delim :
The server's host key is not cached in the registry. You
have no guarantee that the server is the computer you
think it is.
The server's key fingerprint is:
ssh-rsa 1024 e4:c9:51:50:61:63:e9:cd:73:2a:60:6b:f0:be:25:bf
If you trust this host, enter "y" to add the key to
PuTTY's cache and carry on connecting.
If you want to carry on connecting just once, without
adding the key to the cache, enter "n".
If you do not trust this host, press Return to abandon the
connection.
Store key in cache? (y/n) y
Authenticating with public key "imported-openssh-key"
/bin/lis: /proc/20282/exe: Permission denied
dircolors: ~\etc\DIR_COLORS': Permission denied
id:userid:key identifier
1:admin:smith
2:admin:jones

C:\Program Files\IBM\svconconsole\cimom>
```

**Note:** If you are submitting a CLI command with all parameters in single line command mode, you will be challenged upon first appearance of the SSH server host fingerprint. Be careful to ensure that the SSH server host fingerprint is accepted before submitting a batch script file.

The SSH protocol also specifies that once the SSH server public key is accepted, another challenge will be presented if the fingerprint of an SSH server changes from the one previously accepted. In this case, you will need to decide whether to accept this changed host fingerprint. For PuTTY, you answer by typing *y* to accept this host fingerprint. PuTTY stores this information in the registry for the user name which is logged onto Windows.

**Note:** The SSH server keys on the SAN Volume Controller will be regenerated when a microcode load is performed on the cluster. Due to this behavior, you will see a *challenge* presented because the fingerprint of the SSH server has changed.

#### **Related tasks**

“Configuring the PuTTY session for the command-line interface” on page 82  
If you are preparing to run the CLI from the master console, you will need to configure the PuTTY session on the SSH client system.

#### **Related information**

“Using the Command-Line Interface (CLI)” on page 169

The SAN Volume Controller cluster Command-Line Interface (CLI) is a collection of commands you can use to manage the SAN Volume Controller.

## **Configuring the cluster using the CLI**

You can configure the cluster using the command-line interface (CLI).

The initial steps in creating and configuring a cluster must be performed using the front panel and the SAN Volume Controller Console. Once the cluster has been created and a SSH public key has been added all further tasks can be accomplished using the command-line interface (CLI).

Perform the following steps to configure the cluster:

1. Open a command prompt window.
2. To change your time-zones and set your cluster time, you can issue the **svctask settimezone** and **svctask setclustertime** commands.
3. If you wish to use the Command Line Interface (CLI) from additional systems then use the **svctask addsshkey** to add further SSH public keys.
4. If you choose you can review and modify the initial configuration of the cluster that was performed using the front panel and SAN Volume Controller Console:
  - a. Issue the command **svcinfo lscluster** to display the cluster properties. To display full details of your cluster's properties, issue the **svcinfo lscluster -delim : <cluster\_name>** command.
  - b. To modify the passwords, fabric speed or cluster IP address issue the command **svctask chcluster**.
  - c. Issue the command **svctask setpwdreset -show** to view the status of the password reset feature for the front panel, and issue the command **svctask setpwdreset -enable?-disable** to change it.
  - d. To review and modify your featurization settings you can issue the **svcinfo lslicense** and **svctask chlicense** commands.
  - e. If you wish to modify the set up for error notifications to help manage your errors from the cluster, you can issue the **svctask setevent** command to set up SNMP traps.
5. Issue the **svctask mkcluster** command.

6. Enable your featurization settings by issuing the **svctask chlicense** command. You will need to specify whether you want the FlashCopy or Remote Copy enabled or disabled. You can also specify your size capacity for virtualization.
7. To change your time-zones and reset your cluster time, you can issue the **svctask settimezone** and **svctask setclustertime** commands.
8. If you choose to set up error notifications to manage your errors from the cluster, you can issue the **svcservicemodetask setevent** command to set up SNMP traps.

#### Related tasks

“Modifying IP addresses using the CLI” on page 224

You can modify IP addresses using the command-line interface (CLI).

“Maintaining SSH keys using the CLI” on page 225

You can maintain SSH keys using the command-line interface (CLI).

“Modifying passwords using the CLI” on page 226

You can modify the admin and service passwords using the command-line interface (CLI).

“Setting up error notifications using the CLI” on page 225

You can set up error notifications using the command-line interface (CLI).

#### Related information

“Using the Command-Line Interface (CLI)” on page 169

The SAN Volume Controller cluster Command-Line Interface (CLI) is a collection of commands you can use to manage the SAN Volume Controller.

## Setting the cluster time using the CLI

This task provides step-by-step instructions for setting the cluster time using the command-line interface.

Perform the following steps to set the cluster time:

1. Open a command prompt window.
2. Issue the **svcinfo showtimezone** command to display the current time-zone settings for the cluster. The cluster ID and its associated time-zone are displayed.
3. Issue the **svcinfo lstimezones** command to list the time-zones available on the cluster. A list of valid time-zones settings are displayed in a list. The specific cluster ID and its assigned time-zone are indicated in the list.
4. Issue the **svctask settimezone** command to set the time zone for the cluster.
5. Issue the **svctask setclustertime** command to set the time for the cluster.

#### Related information

“Using the Command-Line Interface (CLI)” on page 169

The SAN Volume Controller cluster Command-Line Interface (CLI) is a collection of commands you can use to manage the SAN Volume Controller.

## Reviewing and setting the cluster features using the CLI

You can set up the cluster features using the command-line interface (CLI).

Perform the following steps to set up the cluster features:

1. Open a command prompt window.
2. Issue the **svctask lslicense** command to return the current license (featurization) settings for the cluster. The output displayed lists the feature functions in a list and displays whether they are enabled or disabled.



3. Issue the **svcinfolicense** command to change the licensed settings of the cluster. Because the feature settings are entered when the cluster is first created, you need to update the settings only if you have changed your license. You can change the following values:
  - a. FlashCopy: disabled or enabled
  - b. Remote Copy: disabled or enabled
  - c. Virtualization limit: number, in gigabytes (1073741824 bytes)

#### Related information

“Using the Command-Line Interface (CLI)” on page 169

The SAN Volume Controller cluster Command-Line Interface (CLI) is a collection of commands you can use to manage the SAN Volume Controller.

## Displaying cluster properties using the CLI

You can display cluster properties using the command-line interface (CLI).

Perform the following steps to display cluster properties:

1. Open a command prompt window.
2. Issue the **svcinfolcluster** command to display a concise view of the cluster.

```
svcinfolcluster -delim : 10030a007e5
```

where *10030a007e5* is the name of the cluster. The output from this command will display the following: The output from this command will include the following for each cluster on the fabric:

- a. cluster ID
- b. cluster name
- c. cluster IP address
- d. cluster service mode IP address

#### Related information

“Using the Command-Line Interface (CLI)” on page 169

The SAN Volume Controller cluster Command-Line Interface (CLI) is a collection of commands you can use to manage the SAN Volume Controller.

## Maintaining passwords using the CLI

You can maintain passwords using the command-line interface (CLI).

Perform the following steps to maintain passwords:

1. Open a command prompt window.
2. Issue the **svctask setpwdreset** command to view and change the status of the password-reset feature for the display panel. Passwords can consist of A - Z, a - z, 0 - 9, and underscore. Make a careful note of the admin password, because without it, you cannot access the cluster.

#### Related information

“Using the Command-Line Interface (CLI)” on page 169

The SAN Volume Controller cluster Command-Line Interface (CLI) is a collection of commands you can use to manage the SAN Volume Controller.

---

## Scenario: typical usage for the command-line interface

The main focus of the following example is to provide storage to your host system using the command-line interface (CLI).

For example, you wish to provide a host system with two disks and create a FlashCopy of these two disks. The copy is to be made available to a second host. These two hosts require that the host objects that are created, correspond with the group of WWPNs presented by their fibre-channel HBAs to the SAN. You also need to create four virtual disks, one for each of the disks that are to be presented to the hosts. Once the VDIs are created, you can map two of them to each host. In order to create the VDIs you need to have a managed disk group to be able to create them from. You wish to spread the 8 managed disks across two groups and create the source VDIs from one and the target VDIs from the other. In order to create any of these objects you need to create a cluster and at least add one more node to the cluster.

The following steps illustrates how this can be done:

1. Create a cluster.
2. Configure the cluster with an IP address of 9.20.123.456, a fabric speed of 2 GB. Name the cluster examplecluster.
3. Add nodes
  - knode and lnode to the I/O group called io\_grp0 in the examplecluster cluster
  - mnode and nnode to the I/O group called io\_grp1 in the examplecluster cluster
4. Create the MDisk groups maindiskgroup and bkpdiskgroup
5. Create 4 VDIs
  - 2 VDIs from maindiskgroup
  - 2 VDIs from bkpdiskgroup
6. Create 2 host objects
  - a host object called demohost1 with HBAs that have WWPNs of 10000000C92AD7E5, and 10000000C92F5123
  - a host object called demohost2 with HBAs that have WWPNs of 210000E08B0525D4, and 210100E08B2525D4
7. Create the VDI-to-host mappings
  - Map the two VDIs from maindiskgroup to demohost1
  - Map the two VDIs from bkpdiskgroup to demohost2
8. Create FlashCopy mappings
  - Create a FlashCopy mapping called main1copy that has a background copy rate of 75
  - Create a FlashCopy mapping called main2copy that has a background copy rate of 50
9. Create a FlashCopy consistency group called maintobkpcopy and add the 2 FlashCopy mappings to it
10. Prepare and trigger (start) the FlashCopy Consistency Group that contains these mappings

**Note:** Once this step is complete, you have created and allocated storage to your host systems. You have made two VDIs available to demohost1 and then used FlashCopy to make backup copies on two VDIs which are accessible to demohost2.

#### **Related tasks**

“Configuring a cluster using the SAN Volume Controller Console” on page 106  
Once you’ve created a pair of nodes, you will then need to create and configure a cluster.

“Create cluster from the front panel” on page 69

After you have created a pair of nodes, you can now create a cluster from the front panel.

“Adding nodes to a cluster using the CLI”

You can add nodes to a cluster .

“Displaying node properties using the CLI” on page 186

You can display node properties using the command-line interface (CLI).

“Discovering MDisks using the CLI” on page 187

You can discover MDisks using the command-line interface (CLI).

“Creating managed disk (MDisk) groups using the CLI” on page 188

You can create an MDisk group using the command-line interface (CLI).

“Adding MDisks to MDisk groups using the CLI” on page 190

You can add MDisks to MDisk groups using the command-line interface (CLI).

“Create virtual disks (VDisks)” on page 191

You can create a VDisk using the command-line interface (CLI).

“Creating host objects using the CLI” on page 194

This task provides step-by-step instructions about how to create host objects.

“Create VDisk-to-host mappings using the CLI” on page 195

You can create VDisk-to-host mappings using the command-line interface (CLI).

“Create FlashCopy mappings using the CLI” on page 195

You can create FlashCopy mappings using the command-line interface (CLI).

“Creating a FlashCopy consistency group and adding mappings using the CLI” on page 196

You can create a FlashCopy Consistency Group and add mappings to it using the command-line interface (CLI).

“Preparing and triggering a FlashCopy mapping using the CLI” on page 197

You can prepare and trigger a FlashCopy to start the FlashCopy process using the command-line interface (CLI).

“Preparing and triggering a FlashCopy Consistency Group using the CLI” on page 198

You can prepare and trigger a FlashCopy Consistency Group to start the flash copy process using the command-line interface (CLI).

#### **Related information**

Chapter 4, “Command-Line Interface,” on page 169

## **Adding nodes to a cluster using the CLI**

You can add nodes to a cluster .

Before adding a node to a cluster check to see if any of the following conditions are true:

- The cluster has more than one I/O group.
- The node being added to the cluster uses physical node hardware which has previously been used as a node in the cluster.
- The node being added to the cluster uses physical node hardware which has previously been used as a node in *another* cluster and both clusters have visibility to the same hosts.

**Attention:** If any of these conditions are true, then you must perform the following special procedures. Failure to perform the special procedure is likely to result in the corruption of all data managed by the cluster.

### Special procedures when adding a node to a cluster

If any of the previous conditions are true, then the following special procedures apply. These special procedures apply when you use either the **svctask addnode** command or the SAN Volume Controller Console

When a node is added to a cluster then either:

- The node must be added back to the same I/O group that it was previously in.

**Note:** The WWNN of the nodes in the cluster can be determined using the command:

```
svcinfolnode
```

or, if this information is not available, then

- Call IBM Service to ensure that data is not lost during the Adding a node procedure.

**Note:**

- *Before* the node is added back into the cluster all the hosts using the cluster must be shut down.

The node must then be added before the hosts are rebooted. or, if the I/O group information is not available and it is inconvenient to shutdown and reboot all of the hosts using the cluster, then

- On all the hosts connected to the cluster, unconfigure the Fibre Channel adapter device driver, the disk device driver, and the SDD device driver, before you add the node to the cluster.

Re-configure the Fibre Channel adapter device driver, the disk device driver, and the SDD device driver, after adding the node into the cluster.

**Note:** This may not be possible on all operating systems in all circumstances.

### Hypothetical scenarios where the special procedures may apply.

The following are two hypothetical scenarios where the special procedures may apply:

- Four nodes of a 8-node cluster have been lost because of a complete failure of a pair of uninterruptible power supplies. In this case the four lost nodes must be added back into the cluster using the **svctask addnode** command or the SAN Volume Controller Console.
- A user decides to delete four nodes from the cluster and add them back into the cluster using the **svctask addnode** command or the SAN Volume Controller Console.

Before you begin adding nodes, you must have already created a cluster, performed the initial configuration using the SAN Volume Controller Console and performed the necessary setup to use the Command Line Interface (CLI).

## Background

Applications on host systems direct I/O operations to file systems or logical volumes which are mapped by the operating system to vpaths which are pseudo disk objects supported by the SDD driver. See the *IBM TotalStorage Subsystem Device Driver: User's Guide*.

The SDD driver maintains an association between a vpath and a SAN Volume Controller VDisk. This association uses an identifier (UID) which is unique to the VDisk and is never reused. This allows the SDD driver to unambiguously associate vpaths with VDIsks.

The SDD device driver operates within a protocol stack which also contains Disk and Fibre Channel device drivers which allow it to communicate with the SAN Volume Controller using the SCSI protocol over Fibre Channel as defined by the ANSI FCS standard. The addressing scheme provided by these SCSI and Fibre channel device drivers uses a combination of a SCSI Logical unit number (LUN) and the World Wide Name for the Fibre Channel Node and Ports.

In the event of errors occurring, error recovery procedures (ERPs) operate at various tiers in the protocol stack. Some of these ERPs cause I/O to be re-driven using the same WWN and LUN numbers which were previously used.

The SDD device driver does not check the association of the VDisk with the VPath on every I/O that it performs.

**Important:** Before you begin adding nodes, you must have already created a cluster, performed the initial configuration using the SAN Volume Controller Console and performed the necessary setup to use the Command Line Interface (CLI).

The following examples are all based on our hypothetical scenario of setting up a 8-node cluster. The first node has already been used to create a cluster and therefore there are a further seven nodes to add to the cluster.

Perform the following steps to add nodes to a cluster:

1. Open a command prompt window.
2. Determine the I/O group to which the node should be added. Type the **svcinfo lsnode** command to list the nodes that are currently part of the cluster.

```
svcinfo lsnode -delim :
```

```
id:name:UPS_serial_number:WWNN:status:IO_group_id:  
IO_group_name:config_node:UPS_unique_id  
1:node1:10L3ASH:500507680100002C:online:0:io_grp0:yes:202378101C0D18D8  
....
```

The cluster has only just been created so there is only one node in the cluster.

3. Type the **svcinfo lsnodecandidate** command to list nodes that are not assigned to a cluster and to verify that when adding a second node to an I/O group that it is attached to a different UPS.

```
svcinfolsnodecandidate -delim :  
  
id:panel_name:UPS_serial_number:UPS_unique_id  
5005076801000001:000341:10L3ASH:202378101C0D18D8  
5005076801000009:000237:10L3ANF:202378101C0D1796  
50050768010000F4:001245:10L3ANF:202378101C0D1796  
....
```

There are a total of eight nodes, one of which has been used to create a cluster. Therefore there are seven candidate nodes that can be added to the cluster.

#### 4.

Issue the command **svctask addnode** to add a node to the cluster.

You can specify a name for the node. To change the name of a node that is already part of a cluster, use the **svctask chnode** command.

If you do not specify the name for the node, the node can later be identified by using the front panel name, which is printed on a label on the front of the SAN Volume Controller, or by using the world wide node name of that node.

For the new node, record the following information:

- Node serial number
- WWNN
- All WWPNs
- I/O group that contains the node

This can avoid a possible data corruption exposure if the node must be removed from and re-added to the cluster.

If you are re-adding a node to the cluster, ensure that you are adding the node to the same I/O group that it was removed from. Failure to do this can result in data corruption. Use the information that was recorded when the node was originally added to the cluster. If you do not have access to this information, call IBM Service to add the node back into the cluster without corrupting the data.

Add a second node to the first I/O group by issuing the following command. Note from the output from step 1 that the node that is already in I/O group 0 is attached to a UPS with the serial number 10L3ASH. Each node in an I/O group must be attached to a different UPS and therefore only the nodes with front panel IDs 000237 and 001245 are suitable candidates.

```
svctask addnode -panelname 000237 -iogrp io_grp0 -name group1node2
```

This command adds the node, identified by the front panel name 000237 to the cluster. The node will be added to I/O group, io\_grp0, and called group1node2.

Next add two nodes to the second I/O group. Check the output from step 3 to make sure that each node is attached to a different UPS.

```
svctask addnode -wwnodename 5005076801000001 -iogrp io_grp1 -name group2node1
svctask addnode -wwnodename 50050768010000F4 -iogrp io_grp1 -name group2node2
```

These commands will add the nodes, identified by the WWNN 5005076801000001 and the WWNN 50050768010000F4 to the cluster. The nodes will be added to I/O group, io\_grp1 and called group2node1 and group2node2.

Finally change the name of the first node from the default name node1 so that it conforms with your naming convention.

```
svctask chnode -name group1node1 node1
```

#### 5. Verify the final configuration using the **svcinfolnode** command.

In our hypothetical scenario, the command to list the nodes is:

```
svcinfolnode -delim :
```

```
id:name:UPS_serial_number:WWNN:status:IO_group_id:
IO_group_name:config_node:UPS_unique_id
1:group1node1:10L3ASH:500507680100002C:online:0:io_grp0:yes:202378101C0D18D8
2:group1node2:10L3ANF:5005076801000009:online:0:io_grp0:no:202378101C0D1796
3:group2node1:10L3ASH:5005076801000001:online:1:io_grp1:no:202378101C0D18D8
4:group2node2:10L3ANF:50050768010000F4:online:1:io_grp1:no:202378101C0D1796
....
```

**Note:** If this command is issued quickly after adding nodes to the cluster the status of the nodes may be adding rather than online indicating that the process of adding the nodes to the cluster is still in progress. You do not however have to wait for all the nodes to become online before continuing with the configuration process.

**Remember:** Record the following information:

- Node serial number
- WWNN
- All WWPNNs
- I/O group that contains the node

This can avoid a possible data corruption exposure if the node must be removed from and re-added to the cluster.

You have now added eight nodes to one cluster. The nodes are split into two I/O groups.

#### **Related tasks**

“Registering the SAN Volume Controller Ports with your EMC CLARiiON” on page 275  
To register SAN Volume Controller ports with an EMC CLARiiON controller that has Access Logix installed, complete these steps.

## Displaying node properties using the CLI

You can display node properties using the command-line interface (CLI).

Perform the following steps to display the node properties:

1. Open a command prompt window.
2. Issue the **svcinfolnode** command to display a concise list of nodes in the cluster.

Type the following command:

```
svcinfolnode -delim :
```

This command displays the following:

```
id:name:UPS_serial_number:WWNN:status:IO_group_id:  
  IO_group_name:config_node:UPS_unique_id  
1:group1node1:10L3ASH:500507680100002C:online:0:io_grp0:yes:202378101C0D18D8  
2:group1node2:10L3ANF:5005076801000009:online:0:io_grp0:no:202378101C0D1796  
3:group2node1:10L3ASH:5005076801000001:online:1:io_grp1:no:202378101C0D18D8  
4:group2node2:10L3ANF:50050768010000F4:online:1:io_grp1:no:202378101C0D1796
```

3. Issue the **svcinfolnode** command again, however, this time, specify the node ID or name of a node to receive the detailed output.



For example, to provide a detailed view of the node named group1node1 type the following:

```
svcinfo lsnode -delim : group1node1
```

This command displays the following:

```
id:1
name:group1node1
UPS_serial_number:10L3ASH
WWNN:500507680100002C
status:online
IO_group_id:0
IO_group_name:io_grp0
partner_node_id:2
partner_node_name:group1node2
config_node:yes
UPS_unique_id:202378101C0D18D8
port_id:500507680110002C
port_status:active
port_id:500507680120002C
port_status:active
port_id:500507680130002C
port_status:active
port_id:500507680140003C
port_status:active
```

The output includes:

- node ID
- node name
- WWNN
- details about the uninterruptible power supply to which the node is attached
- details about the I/O group of which the node is a member
- detailed fibre channel port status information.

## Discovering MDisks using the CLI

You can discover MDisks using the command-line interface (CLI).

When backend controllers are added to the fibre-channel SAN and are included in the same switch zone as a SAN Volume Controller Cluster the cluster will automatically discover the backend controller and will integrate the controller to determine what storage it is presented to the SAN Volume Controller. The SCSI LUs presented by the backend controller will be displayed as unmanaged MDisks. If however the configuration of the backend controller is modified after this has occurred then the SAN Volume Controller may be unaware of these configuration changes. This task allows a user to request the SAN Volume Controller to re-scan the fibre-channel SAN to update the list of unmanaged MDisks.

**Note:** The automatic discovery performed by SAN Volume Controller does not write anything to a unmanaged MDisk. It is only when a the user instructs the

SAN Volume Controller to add a MDisk to a managed disk group or use a MDisk to create an image mode virtual disk that the storage will actually be used.

Perform the following steps to display MDisks:

1. Open a command prompt window.
2. Check to see which MDisks are available by issuing the **svctask detectmdisk** command to manually scan the fibre-channel network for any MDisks.
3. Issue the **svcinfolsmdiskcandidate** command to show the unmanaged MDisks. These MDisks have not been assigned to an MDisk group. Alternatively, you can issue the **svcinfolsmdisk** command to view all of the MDisks.

In our hypothetical scenario we have a single backend controller that is presenting eight SCSI LUs to the SAN Volume Controller. Issue the following command:

```
svctask detectmdisk
```

```
svcinfolsmdiskcandidate
```

This command displays the following:

```
id
0
1
2
3
4
5
6
7
```

Issue the following command:

```
svcinfolsmdisk -delim : -filtervalue mode=unmanaged
```

This command displays the following:

```
id:name:status:mode:mdisk_grp_id:mdisk_grp_name:
capacity:ctrl_LUN_#:controller_name
0:mdisk0:online:unmanaged:::273.3GB:0000000000000000:controller0
1:mdisk1:online:unmanaged:::273.3GB:0000000000000001:controller0
2:mdisk2:online:unmanaged:::273.3GB:0000000000000002:controller0
3:mdisk3:online:unmanaged:::273.3GB:0000000000000003:controller0
4:mdisk4:online:unmanaged:::136.7GB:0000000000000004:controller0
5:mdisk5:online:unmanaged:::136.7GB:0000000000000005:controller0
6:mdisk6:online:unmanaged:::136.7GB:0000000000000006:controller0
7:mdisk7:online:unmanaged:::136.7GB:0000000000000007:controller0
```

You have now shown that the backend controllers and switches have been setup correctly and that the SAN Volume Controller can see the storage being presented by the backend controller.

## Creating managed disk (MDisk) groups using the CLI

You can create an MDisk group using the command-line interface (CLI).

**Attention:** If you add a MDisk to a MDisk group as a managed disk, any data on the MDisk will be lost. If you want to keep the data on a MDisk (for example because you want to import storage that was previously not managed by a SAN Volume Controller) then you should create image mode VDisks instead.

Assume that the cluster has been set up and that a backend controller has been configured to present some new storage to the SAN Volume Controller.

Before creating managed disk groups consider how you are going to use your storage. The SAN Volume Controller allows you to create up to 128 managed disks groups and to add up to 128 MDisks to an MDisk group. Consider the following factors when deciding how many managed disk groups to create:

- A virtual disk can only be created using the storage from one managed disk group. Therefore if you create small managed disk groups then you may lose the benefits provided by virtualization, namely more efficient management of free space and a more evenly distributed workload to provide better performance.
- If any managed disk in a managed disk group goes offline then all the virtual disks in the managed disk group will go offline. Therefore you might want to consider using different managed disk groups for different backend controllers or for different applications.
- If you anticipate regularly adding and removing backend controllers or storage then this task will be made simpler by grouping all the managed disks presented by a backend controller into one managed disk group.
- All the managed disks in a managed disk group should have similar levels of performance or reliability, or both. If a managed disk group contains managed disks with different levels of performance then the performance of the virtual disks in this group will be limited by the performance of the slowest managed disk. If a managed disk group contains managed disks with different levels of reliability then the reliability of the virtual disks in this group will be that of the least reliably managed disk in the group.

Even with the best planning, circumstances may change and you may wish to re-configure your managed disk groups after they have been created. The data migration facilities provided by the SAN Volume Controller enable you to move data without disrupting I/O.

**Choosing a managed disk group extent size:** You must specify the extent size when you create a new MDisk group. You cannot change the extent size later; it must remain constant throughout the lifetime of the MDisk group. MDisk groups may have different extent sizes however this will place restrictions on the use of data migration. The choice of extent size affects the total amount of storage that can be managed by a SAN Volume Controller Cluster. Table 15 shows the maximum amount of storage that can be managed by a cluster for each extent size. Because the SAN Volume Controller allocates a whole number of extents to each virtual disk that is created, using a larger extent size may increase the amount of wasted storage at the end of each virtual disk. Larger extent sizes also reduces the ability of the SAN Volume Controller to distribute sequential I/O workloads across many managed disks and hence may reduce the performance benefits of virtualization.

*Table 15. Extent size*

Extent Size	Maximum storage capacity of cluster
16MB	64TB
32MB	128TB

Table 15. Extent size (continued)

64MB	256TB
128MB	512TB
256MB	1PB
512MB	2PB

**Attention:** You can specify different extent sizes for different managed disk groups, however you will not be able to migrate virtual disks between managed disk groups with different extent sizes. Therefore if possible create all your managed disk groups with the same extent size.

Perform the following steps to create a MDisk group:

1. Open a command prompt window.
2. Type the **svctask mkmdiskgrp** command to create a MDisk group.

#### Example

In our hypothetical scenario, the command to create a MDisk group is:  
`svctask mkmdiskgrp -name maindiskgroup -ext 32 -mdisk mdisk0:mdisk1:mdisk2:mdisk3`  
This command will create a MDisk group called *maindiskgroup*. The extent size used within this group will be 32 MB, and there are four MDisks *mdisk0*, *mdisk1*, *mdisk2*, *mdisk3* added to the group.

#### Example

In our hypothetical scenario, the command to create a second MDisk group is:  
`svctask mkmdiskgrp -name bkpdiskgroup -ext 32`

**Note:** In this example we will create a second MDisk group first and add MDisks later.

This command will create a MDisk group called *bkpdiskgroup*. The extent size used within this group will be 32 MB.

#### Example

To add MDisks to the MDisk group, issue the **svctask addmdisk** command. In our hypothetical scenario, the command to add MDisks to the MDisk group is:  
`svctask addmdisk -mdisk mdisk4:mdisk5:mdisk6:mdisk7 bkpdiskgroup`  
This command will add four MDisks *mdisk4*, *mdisk5*, *mdisk6*, *mdisk7* to the MDisk group called *bkpdiskgroup*.

## Adding MDisks to MDisk groups using the CLI

You can add MDisks to MDisk groups using the command-line interface (CLI).

The managed disks must be in unmanaged mode. Disks that already belong to a group cannot be added to another group until they have been deleted from their current group. You can delete a managed disk from a group under the following circumstances:

- If the managed disk does not contain any extents in use by a virtual disk
- If you can first migrate the extents in use onto other free extents within the group.

Perform the following steps to add MDisks to MDisk groups:

1. Open a command prompt window.

2. Type the **svcinfo lsmdiskgrp** command to list the existing MDisk groups.

In our hypothetical scenario, we have two MDisk groups, one with four managed disks and one with no managed disks. Type the following command:

```
svcinfo lsmdiskgrp -delim :
```

This command displays the following:

```
id:name:status:mdisk_count:vdisk_count:
capacity:extent_size:free_capacity
0:maindiskgroup:online:4:0:1093.2GB:32:1093.2GB
1:bkpmdiskgroup:online:0:0:0:32:0
```

3. To add MDisks to the MDisk group, issue the **svctask addmdisk** command.

In our hypothetical scenario, the command to add MDisks to the MDisk group is:

```
svctask addmdisk -mdisk mdisk4:mdisk5:mdisk6:mdisk7 bkpmdiskgroup
```

This command will add four MDisks mdisk4, mdisk5, mdisk6 and mdisk7 to the MDisk group called bkpmdiskgroup.

#### **Related reference**

“Optimal managed disk group configurations” on page 256

A managed disk group provides the pool of storage from which virtual disks will be created. It is therefore necessary to ensure that the entire pool of storage provides the same performance and reliability characteristics.

## **Create virtual disks (VDisks)**

You can create a VDisk using the command-line interface (CLI).

**Note:** If you want to keep the data on a MDisk (for example because you want to import storage that was previously not managed by a SAN Volume Controller) then you should create image mode VDIsks instead. This task only deals with creating VDIsks with a striped virtualization policy. For details of other virtualization policies refer to the *IBM TotalStorage Subsystem Device Driver: User's Guide*.

Assume that the cluster has been setup and that you have created managed disk groups. You must establish an empty managed disk group to hold the MDisks used for image mode VDIsks.

Perform the following steps to create VDIsks:

1. Open a command prompt window.
2. Decide which managed disk group will provide the storage for the VDisk. Use the **svcinfo lsmdiskgrp** command to list the available managed disk groups and the amount of free storage in each group.

In our hypothetical scenario, issue the following:

```
svcinfolsmdiskgrp -delim :
```

This command displays the following:

```
id:name:status:mdisk_count:vdisk_count:
capacity:extent_size:free_capacity
0:mainmdiskgroup:online:4:0:1093.2GB:32:1093.2GB
1:bkpmdiskgroup:online:4:0:546.8GB:32:546.8GB
```

3. Decide which I/O group the VDisk should be assigned to. This determines which SAN Volume Controller nodes in the cluster process the I/O requests from the host systems. If you have more than one I/O group then make sure you distribute the VDIs between the I/O groups so that the I/O workload is shared evenly between all SAN Volume Controller nodes. Use the **svcinfolsiogrp** command to show the I/O groups and the number of virtual disks assigned to each I/O group.

**Note:** It is normal for clusters with more than one I/O group to have MDisk groups that have VDIs in different I/O groups. FlashCopy can be used to make copies of VDIs regardless of whether the source and destination VDisk are in the same I/O group. If however you plan to use intra-cluster remote copy then make sure that both the master and auxiliary VDisk are in the same I/O group.

In our hypothetical scenario, there are two I/O groups each with two nodes. Neither I/O group has any virtual disks yet. Issue the following command:

```
svcinfolsiogrp -delim :
```

This command displays the following:

```
id:name:node_count:vdisk_count
0:io_grp0:2:0
1:io_grp1:2:0
2:io_grp2:0:0
3:io_grp3:0:0
4:recovery_io_grp:0:0
```

4. Type the **svctask mkvdisk** command to create a virtual disk (VDisk).

In our hypothetical scenario, the command to create a VDisk is:

```
svctask mkvdisk -name mainvdisk1 -iogrp 0
-mdiskgrp 0 -vtype striped -size 256 -unit gb
```

This command will create a VDisk called mainvdisk1, the VDisk will use I/O group 0 and MDisk group 0 (the ID of maindiskgroup as shown in the output from step 2). The VDisk capacity is 256GB and will be made up of extents from the MDIs in the MDisk group.

In our hypothetical scenario, the command to create a second VDisk is:

**Note:** This command is the same as the above example, however, here we are specifying the names of the objects instead of the IDs.

```
svctask mkvdisk -name mainvdisk2 -iogrp io_grp0
-mdiskgrp maindiskgroup -vtype striped -size 256 -unit gb
```

This command will create a VDisk called mainvdisk2, the VDisk will use the I/O group named io\_grp0 and the MDisk group named maindiskgroup. The VDisk capacity is 256GB and will be made up of extents from the MDisks in the MDisk group.

In our hypothetical scenario, the commands to create a third VDisk is:

**Note:** This virtual disk is created with an ordered list of MDisks within the MDisk group to allocate extents from.

The following command lists the managed disks in the MDisk group with ID 1 (named bkpmddiskgroup):

```
svcinfolsmddisk -delim : -filtervalue mddisk_grp_id=1
```

This command displays the following:

```
id:name:status:mode:mddisk_grp_id:
mddisk_grp_name:capacity:ctrl_LUN_#:
controller_name
4:mddisk4:online:managed:1:bkpmddiskgroup:
136.7GB:0000000000000004:controller0
5:mddisk5:online:managed:1:bkpmddiskgroup:
136.7GB:0000000000000005:controller0
6:mddisk6:online:managed:1:bkpmddiskgroup:
136.7GB:0000000000000006:controller0
7:mddisk7:online:managed:1:bkpmddiskgroup:
136.7GB:0000000000000007:controller0
```

Issue the following command:

```
svctask mkvdisk -name bkpvddisk1 -iogrp io_grp1
-mdiskgrp bkpmddiskgrp -vtype striped -size 256
-unit gb -mddisk 4:5
```

This command will create a VDisk called bkpvddisk1, the Vdisk will use the I/O group named io\_grp1 and the MDisk group named bkpmddiskgrp. The VDisk capacity is 256GB and will be made up of extents allocated from the MDisks with IDs 4 and 5.

In our hypothetical scenario, the command to create a fourth VDisk is:

```
svctask mkvdisk -name bkpvdisk2 -iogrp io_grp1
-mdiskgrp bkpmdiskgrp -vtype striped -size 256 -unit
gb -mdisk mdisk6:mdisk7
```

This command will create a VDisk called `bkpvdisk2`, the VDisk will use the I/O group named `io_grp1` and the MDisk group named `bkpmdiskgrp`. The VDisk capacity is 256GB and will be made up of extents allocated from the MDisks with names `mdisk6` and `mdisk7`.

5. To list all the virtual disks that have been created use the **svcinfolsvdisk** command.

In our hypothetical scenario we have created four VDIs. Issue the following command:

```
svcinfolsvdisk -delim :
```

This command displays the following:

```
id:name:I0_group_id:I0_group_name:status:
mdisk_grp_id:mdisk_grp_name:capacity:type:FC_id:
FC_name:RC_id:RC_name
0:mainvdisk1:0:io_grp0:online:0:mainmdiskgroup:
512.0GB:striped:::
1:mainvdisk2:0:io_grp0:online:0:mainmdiskgroup:
512.0GB:striped:::
2:bkpvdisk1:1:io_grp1:online:1:bkpmdiskgroup:
512.0GB:striped:::
3:bkpvdisk2:1:io_grp1:online:1:bkpmdiskgroup:
512.0GB:striped:::
```

## Creating host objects using the CLI

This task provides step-by-step instructions about how to create host objects.

1. Open a command prompt window.
2. Type the **svctask mkhost** command to create a logical host object. Assign your WWPN for the HBAs in the hosts.

In our hypothetical scenario, the command to create a host is:

```
svctask mkhost -name demohost1 -hbawwpn 210100e08b251dd4
```

This command will create a host called *demohost1* with the HBA WWPN of *210100e08b251dd4*.

3. Type the **svctask addhostport** command to add ports to the host.

In our hypothetical scenario, the command to add a port to the host is:

```
svctask mkhost -name demohost2 -hbawwpn 210100e08b251dd5
```

This command will add another HBA WWPN called *210100e08b251dd5* to the host that we created in step 2.



In our hypothetical scenario, the command to create a second host is:  
`svctask mkhost -hbawpn 210100e08b251dd6:210100e08b251dd7 -name demohost2`

This command will create a second host called *demohost2* with the HBA WWPN of *210100e08b251dd6*, *210100e08b251dd7*.

**Note:** If you were to add a host with a faulty WWPN, or the WWPN had been assigned to the wrong host, you will need to issue the **svctask addhostport** command to add that same host with the correct WWPN, then issue the **svctask rmhostport** command to delete the host with the wrong or faulty WWPN. For example, if you had a host called *demohost1* and its WWPN stopped working, you would need to issue the following:

```
svctask addhostport -hbawpn 210100e08b251dd4 demohost1
```

This would add the host called *demohost1* with the WWPN, *210100e08b251dd4*. You would then need to issue the **svctask rmhostport** command to delete the host with the WWPN that had stopped working. For example, you would issue the following:

```
svctask rmhostport -hbawpn 210100e08b251dd5 demohost1
```

From these two commands, you have deleted the host with the WWPN *210100e08b251dd5*, and have added the same host with the WWPN *210100e08b251dd4*.

## Create VDisk-to-host mappings using the CLI

You can create VDisk-to-host mappings using the command-line interface (CLI).

We are going to map the VDIsks named, *mainvdisk1* and *mainvdisk2*, to the host named *demohost1*. We are also going to map the VDIsks named, *bkpvdisk1* and *bkpvdisk2*, to the host named *demohost2*. The VDIsks, *mainvdisk1* and *mainvdisk2*, are contained in the managed disk (MDisk) group, *mainmdiskgroup*; while the VDIsks, *bkpvdisk1* and *bkpvdisk2*, are contained in the MDisk group, *bkpmdiskgroup*.

Perform the following steps to create VDisk-to-host mappings:

1. Open a command prompt window.
2. Type the **svctask mkvdiskhostmap** to create VDisk-to-host mappings.

In our hypothetical scenario, the commands to create VDisk-to-host mappings are:

```
svctask mkvdiskhostmap -host demohost1 mainvdisk1
svctask mkvdiskhostmap -host demohost1 mainvdisk2
svctask mkvdiskhostmap -host demohost2 bkpvdisk1
svctask mkvdiskhostmap -host demohost2 bkpvdisk2
```

The above set of commands map each VDisk to a host.

## Create FlashCopy mappings using the CLI

You can create FlashCopy mappings using the command-line interface (CLI).

We are going to create mappings that enable us to copy the VDisk, *mainvdisk1*, to *bkpvdisk1* and the VDisk, *mainvdisk2* to *bkpvdisk2*.

The mapping specifies the source and destination virtual disks. The destination must be identical in size to the source, or the mapping will fail. Issue the **svcinfolsvdisk -bytes** command to find the exact size of the source VDisk that you want to create a target disk of the same size. The source and destination cannot be in an existing mapping. That is, a virtual disk can be either a source or a destination disk in **only one** mapping. A mapping is triggered at the point in time when the copy is required.

Perform the following steps to create FlashCopy mappings:

1. Open a command prompt window.
2. Type the **svctask mkfcmap** command to create a FlashCopy mapping.

In our hypothetical scenario, the commands to create FlashCopy mappings are:

```
svctask mkfcmap -source mainvdisk1 -target bkpvdisk1
  -name main1copy -copyrate 75
svctask mkfcmap -source mainvdisk2 -target bkpvdisk2
  -name main2copy
```

The above commands create two FlashCopy mappings. For main1copy the background copy rate is 75; for main2copy, because the rate is not specified in the **mkfcmap** command, the priority is the default, 50.

3. To check the attributes of the mappings that have been created, issue the following **svcinfolsfcmmap** command:

```
svcinfolsfcmmap -delim :
id:name:source vdisk id:source vdisk name:target
  vdisk id:target vdisk name:group id:group
name:status:progress:copy rate
0:main1copy:0:mainvdisk1:1:bkpvdisk1:::idle_copied:::75
1:main2copy:2:mainvdisk2:3:bkpvdisk2:::idle_copied:::50
```

## Creating a FlashCopy consistency group and adding mappings using the CLI

You can create a FlashCopy Consistency Group and add mappings to it using the command-line interface (CLI).

If you have created several FlashCopy mappings for a group of VDIs that contain elements of data for the same application, you may find it convenient to assign these mappings to a single FlashCopy Consistency Group. Then you can issue a single prepare or trigger command for the whole group, so that, for example, all the files for a particular database are copied at the same time.

Perform the following steps to create a FlashCopy mappings:

1. Open a command prompt window.
2. Issue the **svctask mkfcconsistgrp** command to create a FlashCopy Consistency Group.

In our hypothetical scenario, the command to create a FlashCopy Consistency group called *maintobkpfcopy* is:

```
svctask mkfcconsistgrp -name maintobkpfcopy
```

Use the **svcinfn lsfcconsistgrp** command to display the attributes of the group you have created.

```
svcinfn lsfcconsistgrp -delim :
```

This command displays the following:

```
id:name:status
1:maintobkpfcopy:idle_copied
```

3. Use the **svctask chfcmap** command to add the two FlashCopy mappings created in the previous section to the new consistency group.

In our hypothetical scenario, the commands to add the mappings called *main1copy* and *main2copy* to the consistency group called *maintobkpfcopy* are:

```
svctask chfcmap -consistgrp maintobkpfcopy main1copy
svctask chfcmap -consistgrp maintobkpfcopy main2copy
```

Use the **svcinfn lsfcmap** command to display the new attributes of the mappings.

```
svcinfn lsfcmap -delim :
id:name:source_vdisk_id:source_vdisk_name:target_vdisk_id:
target_vdisk_name:group_id:group_name:state:progress:copy_rate
0:main1copy:28:maindisk1:29:bkpdisk1:1:maintobkpfcopy:idle_copied::75
1:main2copy:30:maindisk2:31:bkpdisk2:1:maintobkpfcopy:idle_copied::50
```

Notice that the *group\_name* field displays *maintobkpfcopy* for both mappings.

Use the **svcinfn lsfcconsistgrp** command with the name of the consistency group to display the detailed attributes of the group. This now includes a list of the IDs and names of the mappings that are in the group.

```
svcinfn lsfcconsistgrp -delim : maintobkpfcopy
id:1
name:maintobkpfcopy
status:idle_copied
FC_mapping_id:0
FC_mapping_name:main1copy
FC_mapping_id:1
FC_mapping_name:main2copy
```

#### **Related reference**

“Considerations for FlashCopy mappings” on page 257

Ensure that you’ve considered the type of I/O and frequency of update before creating the virtual disks that you wish to use in FlashCopy mappings.

## **Preparing and triggering a FlashCopy mapping using the CLI**

You can prepare and trigger a FlashCopy to start the FlashCopy process using the command-line interface (CLI).

This will create a point-in-time copy of the data on the source VDisk and write it to the target VDisk for the mapping.

Perform the following steps to prepare and trigger a FlashCopy mapping:

1. Open a command prompt window.
2. Issue the **svctask prestartfcmap** command to prepare the FlashCopy mapping before the copy process can be started (triggered).

In our hypothetical scenario, the command to prepare a FlashCopy mapping called main1copy is:

```
svctask prestartfcmap main1copy
```

The mapping will enter the preparing state, and then move to the prepared state when it is ready. Issue the **svcinfolsfccmap** command to check:

```
svcinfolsfccmap -delim :
id:name:source_vdisk_id:source_vdisk_name:target_vdisk_id:
target_vdisk_name:group_id:group_name:status:progress:copy_rate
0:main1copy:0:mainvdisk1:1:bkpvdisk1:::prepared:0:50
```

3. Issue the **svctask startfcmap** command to start (trigger) the FlashCopy mapping to make the copy.

In our hypothetical scenario, the command to trigger a FlashCopy mapping called main1copy is:

```
svctask startfcmap main1copy
```

4. Use the **svcinfolsfcmapprogress** command to check the progress of the mapping.

```
svcinfolsfcmapprogress -delim : main1copy
id:progress
0:47
```

When the copy is complete the output to the **svcinfolsfccmap** command will show the progress at 100 and the status as idle\_or\_copied.

```
svcinfolsfccmap -delim :
id:name:source_vdisk_id:source_vdisk_name:target_vdisk_id:
target_vdisk_name:group_id:group_name:status:progress:copy_rate
0:main1copy:0:mainvdisk1:1:bkpvdisk1:::idle_or_copied:100:50
```

The output to **svcinfolsfcmapprogress** will show the progress at 100 for example,

```
svcinfolsfcmapprogress main1copy
id      progress
0       100
```

You have now made a point-in-time copy of the data on mainvdisk1 which has been written to bkpvdisk1. The data on bkpvdisk1 will be visible to demohost2 because these VDIs are only mapped to demohost2.

## Preparing and triggering a FlashCopy Consistency Group using the CLI

You can prepare and trigger a FlashCopy Consistency Group to start the flash copy process using the command-line interface (CLI).

Starting the FlashCopy process will create a point-in-time copy of the data on the source VDisk and write it to the target VDisk for each mapping in the group.

Perform the following steps to prepare and trigger a FlashCopy consistency group:

1. Open a command prompt window.
2. Issue the **svctask prestartfcconsistgrp** command to prepare the FlashCopy Consistency Group before the copy process can be started (triggered). When you have assigned several mappings to a FlashCopy Consistency Group, you only have to issue a single prepare command for the whole group, to prepare all the mappings at once.

In our hypothetical scenario, the command to prepare a FlashCopy Consistency group called *maintobkpcopy* is:

```
svctask prestartfcconsistgrp maintobkpcopy
```

The group will enter the preparing state, and then move to the prepared state when it is ready. Issue the **svcinfolsfconsistgrp** command to check:

```
svcinfolsfconsistgrp -delim :  
id:name:status  
1:maintobkpcopy:prepared
```

3. Issue the **svctask startfcconsistgrp** command to start (trigger) the FlashCopy Consistency Group to make the copy. You only have to issue a single start command for the whole group, to trigger all the mappings at once.

In our hypothetical scenario, the command to trigger a FlashCopy Consistency group called *maintobkpfcopy* is:

```
svctask startfcconsistgrp maintobkpfcopy
```

The group will enter the copying state, and then return to the *idle\_copied* state when complete. You can issue the **svcinfc lsfcconsistgrp** command to check the state of the group:

```
svcinfc lsfcconsistgrp -delim :  
id:name:state  
1:maintobkpfcopy:copying
```

Use the **svcinfc lsfcmappprogress** command to check the progress of each mapping, *main1copy* and *main2copy*:

```
svcinfc lsfcmappprogress -delim : main1copy  
id:progress  
0:100
```

```
svcinfc lsfcmappprogress -delim : main2copy  
id:progress  
1:23
```

Finally issue the **svcinfc lsfcconsistgrp** command to display the detailed view of the group *maintobkpfcopy*, which returns to *idle\_copied* state when both mappings have reached 100% progress:

```
svcinfc lsfcconsistgrp -delim : maintobkpfcopy  
id:1  
name:maintobkpfcopy  
state:idle_copied  
FC_mapping_id:0  
FC_mapping_name:main1copy  
FC_mapping_id:1  
FC_mapping_name:main2copy
```

You have now made a point-in-time copy of the data on *mainvdisk1* which has been written to *bkpvdisk1*, and a copy of the data on *mainvdisk2* which has been written to *bkpvdisk2*. The data on *bkpvdisk1* and *bkpvdisk2* will be visible to *demohost2* because these VDisks are only mapped to *demohost2*.

---

## Advanced functions with the CLI

Ensure that you are familiar with the advanced functions that you can perform using the command-line interface (CLI).

### Related information

Chapter 4, “Command-Line Interface,” on page 169

## Determining the WWPNs of a node using the CLI

You can determine the WWPNs of a node using the command-line interface (CLI).

Perform the following steps to determine the WWPNs of a node:

1. List the nodes in the cluster by issuing the following command:

```
svcinfolsnode
```

**Note:** Remember the node name or ID as you will need it in the next step.

2. For the node or nodes in question, issue the following command:

```
svcinfolsnode <nodename/id>
```

**Note:** Remember the four port ID's (WWPNs).

## Determining the VDisk name from the vpath number on the host

You can determine the VDisk name from the vpath number on the host using the command-line interface (CLI).

Each VDisk exported by the SAN Volume Controller is assigned a unique vpath number. This number uniquely identifies the VDisk and can be used to determine which VDisk corresponds to the volume that the hosts sees. This procedure can only be performed using the command line interface.

Perform the following steps to determine the VDisk name from the vpath number:

1. For the volume in question, find the vpath serial number by issuing the following command:

```
datapath query device
```

2. Find the host object defined to the SAN Volume Controller that corresponds with the host you are working with.
  - a. The WWPNs are an attribute of the HBA. You can find these by looking at the device definitions stored by your operating system. For example, on AIX they will be in the ODM, in Windows they will be in the Device Manager details for the given HBA.
  - b. Verify which host object defined to the SAN Volume Controller that these ports belong to. The ports are stored as part of the detailed view, so you will need to list each host in turn by issuing the following:

```
svcinfolshost <name/id>
```

where <name/id> is the name or ID of the host. Check for matching WWPNs.

**Note:** You should name your hosts accordingly, for example, if the actual host is called *orange* you should also name the host object defined to the SAN Volume Controller as *orange*.

3. Now that you have the <host name> as defined to the SAN Volume Controller and the <vpath serial number>, issue the following command:

```
svcinfolshostvdiskmap <hostname>
```

where <hostname> is the name of the host. A list is displayed.

4. Look for the VDisk UID that matches the <vpath serial number> and remember the VDisk name or ID.

## Determining the host that a VDisk is mapped to

You can determine the host that a VDisk is mapped to using the command-line interface (CLI).

Perform the following steps to determine the host that the VDisk is mapped to:

1. Find the VDisk name or ID that you wish to check.
2. List the hosts that this VDisk is mapped, by issuing the following command:

```
svcinfolsvdiskhostmap <vdiskname/id>
```

where *<vdiskname/id>* is the name or ID of the VDisk. A list is displayed.

3. Look for the host name or ID to determine which host this VDisk is mapped to. If no data is returned, the VDisk is not mapped to any hosts.

## Determining the relationship between VDIs and MDIs using the CLI

You can determine the relationship between VDIs and MDIs using the command-line interface (CLI).

Every VDisk is constructed from one or more MDIs. At times you may need to determine the relationship between the two objects. The following procedure allows you to determine the relationships.

1. Perform the following steps to determine the relationship between VDIs and MDIs:
  - a. For a given VDisk *<vdiskname/id>*, issue the following command: `svcinfolsvdiskmember <vdiskname/id>` where *<vdiskname/id>* is the name or ID of the VDisk. This will return a list of IDs that correspond to the MDIs that make up the VDisk.
2. Perform the following steps to determine the relationship between VDIs and MDIs and the number of extents provided by each MDI: If you wish more details, you can also determine the number of extents that make are being provided by each MDI. This procedure can only be performed using the command line interface.
  - a. For a given VDisk *<vdiskname/id>*, issue the following command: `svcinfolsvdiskextent <vdiskname/id>` where *<vdiskname/id>* is the name or ID of the VDisk. This will return a table of MDI IDs and the corresponding number of extents each MDI is providing as storage for the given VDisk.
3. Perform the following steps to determine the relationship between MDIs and VDIs:
  - a. For a given MDI *<mdiskname/id>*, issue the following command: `svcinfolsmdiskmember <mdiskname/id>` where *<mdiskname/id>* is the name or ID of the MDI. This will return a list of IDs that correspond to the VDIs that are using this MDI.
4. Perform the following steps to determine the relationship between MDIs and VDIs and the number of extents used by each VDisk: If you wish more details, you can also determine the number of extents that this MDI is providing for each VDisk. This procedure can only be performed using the command line interface.
  - a. For a given MDI *<mdiskname/id>*, issue the following command: `svcinfolsmdiskextent <mdiskname/id>` where *<mdiskname/id>* is the name or ID of the MDI. This returns a table of VDisk IDs and the corresponding number of extents being used by each VDisk.



## Determining the relationship between MDisks and RAID arrays or LUNs using the CLI

You can determine the relationship between MDisks and RAID arrays or LUNs using the command-line interface (CLI).

Each MDisk corresponds with a single RAID array, or a single partition on a given RAID array. Each RAID controller will define a LUN number for this disk. The LUN number and controller name or ID are needed to be able to determine the relationship between MDisks and RAID arrays or partitions.

Perform the following steps to determine the relationship between MDisks and RAID arrays:

1. Show the detailed view of the given MDisk <mdiskname>, by issuing the following command:

```
svcinfolsmdisk <mdiskname>
```

**Note:** Remember the controller name or controller ID and controller LUN number.

2. Show the detailed view of the controller determined in by issuing the following command:

```
svcinfolcontroller <controllername>  
where <controllername> is the name of the controller.
```

**Note:** Remember the vendor ID, product ID, and WWNN. Use these to determine what is being presented to the MDisk.

3. From the native user interface for the given controller, list the LUNs it is presenting and match the LUN number with that noted in 1. This will tell you the exact RAID array or partition that corresponds with the MDisk.

## Increasing the size of your cluster using the CLI

You can increase the size of a cluster using the command-line interface (CLI).

To increase the size of your cluster you need to add nodes in pairs to a new I/O group. Your existing cluster may have become a bottleneck and so you wish to increase throughput by adding more nodes to the cluster.

Perform the following steps to increase the size of your cluster:

1. Perform the steps in the section and repeat this procedure for the second node.
2. If you wish to balance the load between the existing I/O groups and the new I/O groups, follow the procedure. Repeat this procedure for all VDIsks you want to assign to the new I/O group.

### Related tasks

“Adding a node to increase the size of your cluster using the CLI” on page 204  
You can add a node to increase the size of your cluster using the command-line interface (CLI).

“Migrating a VDisk to a new I/O group” on page 205

You can migrate a VDisk to a new I/O group to increase the size of your cluster using the command-line interface (CLI).

## Adding a node to increase the size of your cluster using the CLI

You can add a node to increase the size of your cluster using the command-line interface (CLI).

Perform the following steps to add a node to increase the size of your cluster:

1. Issue the following command to verify that the node can be seen on the fabric:

```
svcinfolnodecandidate
```

**Note:** Remember the WWNN's. You will need it in the following step.

2. Issue the following command to determine the I/O group you wish to add the nodes to:

```
svcinfolsiogrp
```

3. Select the first I/O group listed that has a node count = 0.

**Note:** Remember the I/O group name or ID. You will need it in the following step.

- 4.

**Attention:** If you are re-adding a node to the SAN, ensure that you are adding the node to the same I/O group that it was removed from. Failure to do this can result in data corruption. Use the information that was recorded when the node was originally added to the cluster. If you do not have access to this information, call IBM Service to add the node back into the cluster without corrupting the data.

If you are adding the node into the cluster for the first time, record the following information:

- Node serial number
- WWNN
- All WWPNs
- I/O group that contains the node

This can avoid a possible data corruption exposure if the node must be removed from and re-added to the cluster.

**Note:** This warning also is displayed on the SAN Volume Controller Console panel when adding the node.

Issue the following command to add the node into the cluster. The <newnodename> is the name you wish to assign to this node. `svctask addnode -wwnodename <WWNN> -iogrp <newiogrpname/id> [-name <newnodename>]`

5. Issue the following command to verify that the node is online:

```
svcinfolnode
```

You may also need to modify the configuration of your disk controllers. If your controller uses a mapping technique to present its RAID arrays or partitions to the cluster you will need to modify the port groups that belong to the cluster because the WWNN and WWPN's of the node have changed.

**Related reference**

“Configuring and servicing storage subsystems” on page 253

Follow the guidelines and procedures outlined in this section to make the most of the performance available from your storage subsystems and to avoid potential I/O problems.

## Migrating a VDisk to a new I/O group

You can migrate a VDisk to a new I/O group to increase the size of your cluster using the command-line interface (CLI).

You can migrate a VDisk to a new I/O group to manually balance the workload across the nodes in the cluster. You may end up with a pair of nodes that are overworked and another pair that are under-worked. Follow this procedure to migrate a single VDisk to a new I/O group. Repeat for other VDIs as required.

**Attention:** This is a disruptive procedure, access to the VDisk will be lost while you follow this procedure. Under no circumstances should VDIs be moved to an offline I/O group. You must ensure the I/O group is online before moving the VDIs to avoid data loss scenarios.

Perform the following steps to migrate a single VDisk:

1. Quiesce all I/O operations for the VDisk. You may need to determine the hosts that are using this VDisk.
2. Before migrating the VDisk, it is essential that for each vpath presented by the VDisk you intend to move, the SDD configuration is updated to remove the vpaths in question. Failure to do this may result in data corruption. See *IBM TotalStorage Subsystem Device Driver: User's Guide* for details about how to dynamically re-configure SDD for the given host operating system.
3. Any FlashCopy mappings or Remote Copy relationships that use this VDisk should be stopped or deleted. Issue the following command, to check if the VDisk is part of a relationship or mapping:

```
svcinfo lsvdisk <vdiskname/id> where <vdiskname/id>  
is the name or ID of the VDisk.
```

4. Look for the **FC\_id** and **RC\_id** fields. If these are not blank then the VDisk is part of a mapping or relationship. *IBM TotalStorage Subsystem Device Driver: User's Guide* for details on how to stop or delete the mapping or relationship.
5. Issue the following command to migrate the VDisk:

```
svctask chvdisk -iogrp <newiogrpname/id> <vdiskname/id>
```

6. Follow the procedure to discover the new vpaths and to check that each vpath is now presenting the correct number of paths. See the *IBM TotalStorage Subsystem Device Driver: User's Guide* for details on how to dynamically re-configure SDD for the given host operating system.

### Related tasks

“Determining the host that a VDisk is mapped to” on page 202

You can determine the host that a VDisk is mapped to using the command-line interface (CLI).

“Determining the relationship between VDIs and MDIs using the CLI” on page 202

You can determine the relationship between VDIs and MDIs using the command-line interface (CLI).

## Replacing a faulty node in the cluster using the CLI

You can replace a faulty node in the cluster using the command-line interface (CLI).

Before you attempt to replace a faulty node with a spare node you must ensure that:

- SAN Volume Controller version 1.1.1 or higher is installed on the cluster and on the spare node. The code levels are available from the node and cluster VPD. You can also issue the **svcinfo lsnode** or **svcinfo lscluster** commands to determine the SAN Volume Controller version.
- You know the name of the cluster that contains the faulty node.
- A spare node is installed in the same rack as the cluster that contains the faulty node.
- Make a record of the last five characters of the original worldwide node name (WWNN) of the spare node. You will need this information, if and when, you want to stop using this node as a spare node. In that case, you might prefer to use it as a normal node that can be assigned to any cluster.

Perform the following steps to display and record the WWNN of the spare node:

1. Display the node status on the front panel display of the node. See the topic, "SAN Volume Controller menu options" in the *IBM TotalStorage SAN Volume Controller: Service Guide* for more information.
2. With the node status displayed on the front panel, press and hold the **Down** button. At the same time press and release the **Select** button. Then release the **Down** button. WWNN is displayed on line-1 of the display; line-2 of the display contains the last five characters of the WWNN.
3. Record the WWNN in a safe place. It will be needed if you want to stop using the spare node.

If a node fails, the cluster continues to operate with degraded performance until the faulty node is repaired. If the repair operation is likely to take an unacceptable amount of time, it might be useful to replace the faulty node with a spare node. However, the appropriate procedures must be followed and precautions must be taken in order not to interrupt I/O operations and to avoid compromising the integrity of your data. The procedures outlined in this topic involve changing the worldwide node name (WWNN) of a SAN Volume Controller. These procedures must be followed with care in order to avoid duplicate WWPNs which can cause data corruption.

Be aware that by performing these procedures the following changes will be made to your configuration:

### Front Panel ID

This number will change. It is the number that is printed on the front of the node and used to select the node that is to be added to a cluster.

### Node Name

This number might change. If you do not specify a name, the SAN Volume Controller assigns a default name when adding a node to a cluster. The SAN Volume Controller creates a new name each time a node is added to a cluster. If you choose to assign your own names then you need to type in the node name on the Adding a node to a cluster panel. If you are using scripts to perform management tasks on the cluster and those scripts use the node name, then by assigning the original name to a replacement node you avoid the need to make changes to the scripts.

## Node ID

This ID will change. A new node ID is assigned each time a node is added to a cluster; the node name remains the same following service activity on the cluster. You can use the node ID or the node name to perform management tasks on the cluster. However, if you are using scripts to perform those tasks use the node name rather than the node ID.

## Worldwide Node Name

This name will change. The WWNN is used to uniquely identify the node and the fibre-channel ports. The WWNN of the spare node will change to that of the faulty node. The node replacement procedures must be followed exactly to avoid any duplication of WWNNs.

## Worldwide Port Names

These names do not change. WWPNS are derived from the WWNN that is written to the spare (replacement) node as part of this procedure. For example, let's say the WWNN for a node is 50050768010000F6. The four WWPNS for this node would be derived as follows:

WWNN	50050768010000F6
WWNN displayed on front panel	000F6
WWPN Port 1	50050768014000F6
WWPN Port 2	50050768013000F6
WWPN Port 3	50050768011000F6
WWPN Port 4	50050768012000F6

Perform the following steps to replace a faulty node in the cluster:

1. Verify the name and ID of the node that you wish to replace.

Perform the following steps to verify the name and ID:

- a. Open a DOS window.
- b. Type the **svcinfolnode** command and press **Enter**.

If the node was faulty it will be shown as offline. Ensure the partner node in the I/O group is online.

- 1) If the other node in the I/O group is offline, start the Directed Maintenance Procedures to determine the fault.
- 2) If you have been directed here by the DMPs, and subsequently the partner node in the I/O group has failed.

If you are replacing the node for other reasons, determine the node you wish to replace and again ensure the partner node in the I/O group is online.

- 1) If the partner node is offline, you will lose access to the VDisks that belong to this I/O group if you continue. Start the Directed Maintenance Procedures and fix the other node before proceeding.

2. Find and record the following information about the faulty node:

- a. Node name
- b. I/O group name
- c. Last five characters of the WWNN
- d. Front panel ID
- e. UPS serial number

- a. To find and record the node name and I/O group name, type the **svcinfolnode** command and hit **Enter**.

The faulty node will be offline.

- b. Record the following information about the faulty node:

- Node name

- I/O group name
- c. To find and record the last five characters of the WWNN, type the **svcinfolnodevdpd <nodename>** command and hit **Enter**. <nodename> is the name that you recorded in step 1 on page 207.
  - d. Find the **WWNN** field in the output. Record the last five characters of the WWNN.
  - e. To find and record the front panel ID, type the **svcinfolnodevdpd <nodename>** command and hit **Enter**. <nodename> is the name that you recorded in step 1 on page 207.
  - f. Find the **front\_panel\_id** field in the output. Record the front panel ID.
  - g. To find and record the UPS serial number, type the **svcinfolnodevdpd <nodename>** command and hit **Enter**. <nodename> is the name that you recorded in step 1 on page 207.
  - h. Find the **UPS\_serial\_number** field in the output. Record the UPS serial number.

3. Obtain the ID of the faulty node. Disconnect all four fibre-channel cables from the node.

**Important:** Do not plug the fibre-channel cables into the spare node until spare node has been configured with the WWNN from the faulty node.

4. Connect the power and signal cables from the spare node to the UPS that has the serial number that you noted in step 5h.

**Note:** The signal cable can be plugged into any vacant position on the top row of serial connectors on the UPS. If no spare serial connectors are available on the UPS, disconnect the cables from the faulty SAN Volume Controller.

5. Power-on the spare node.
6. Display the node status on the service panel. See the topic "SAN Volume Controller menu options" in the *IBM TotalStorage SAN Volume Controller: Service Guide* for more information.

7. Change the WWNN of the spare node.

Perform the following steps to change the WWNN of the spare node so that it matches the WWNN of the faulty node:

- a. With the node status displayed on the front panel, press and hold the **Down** button; press and release the **Select** button; release the **Down** button. WWNN is displayed on line-1 of the display; line-2 of the display contains the last five characters of the WWNN.
- b. With the WWNN displayed on the service panel, press and hold the **Down** button, press and release the **Select** button, release the **Down** button. This switches the display into edit mode. Change the displayed number to match the WWNN recorded in 5d.

**Note:** To edit the displayed number use the **Up** and **Down** buttons to increase or decrease the numbers displayed. Use the **Left** and **Right** buttons to move between fields. When the five characters match the number recorded in step 1 on page 207, press the **Select** button twice to accept the number.

8. Connect the four fibre-channel cables that were disconnected from the faulty node to the spare node.
9. Having noted the <nodename> in step 1 on page 207, remove the node from the cluster by issuing the following **svctask rmnode <nodename/id>** command:

**Remember:** Record the following information:

- Node serial number
- WWNN
- All WWPNNs
- I/O group that contains the node

This can avoid a possible data corruption exposure when the node is re-added to the cluster.

10. Issue the following command to add the node back into the cluster: **svctask addnode -wwnodename <WWNN> -iogrp <IOGRPNAME/ID> -name <NODENAME>**.
11. Use the Subsystem Device Driver (SDD) management tool on the host systems to verify that all paths are now online. See the *IBM TotalStorage Subsystem Device Driver: User's Guide* for more information.

**Attention:** When the faulty node is repaired do not connect the fibre-channel cables to it. Connecting the cables might cause data corruption.
12. Repair the faulty node.
13. If you want to use the repaired node as a spare node, perform the following steps:
  - a. Display the node status on the front panel display of the node. See the topic, "SAN Volume Controller menu options" in the *IBM TotalStorage SAN Volume Controller: Service Guide* for more information.
  - b. With the node status displayed on the front panel, press and hold the **Down** button; press and release the **Select** button; release the **Down** button. WWNN is displayed on line-1 of the display; line-2 of the display contains the last five characters of the WWNN.
  - c. With the WWNN displayed on the service panel, press and hold the **Down** button, press and release the **Select** button, release the **Down** button. This switches the display into edit mode. Change the displayed number to 00000.

**Note:** To edit the displayed number use the **Up** and **Down** buttons to increase or decrease the numbers displayed. Use the **Left** and **Right** buttons to move between fields.

This SAN Volume Controller can now be used as a spare node.

**Attention:** Never connect a SAN Volume Controller with a WWNN of 00000 to the cluster. If this SAN Volume Controller is no longer required as a spare and is to be used for normal attachment to a cluster you must first use the procedure described in the prerequisites to change the WWNN to the number you recorded when a spare was created. Using any other number might cause data corruption.

14. Issue the following command to add the node back into the cluster: **svctask addnode -wwnodename <WWNN> -iogrp <IOGRPNAME/ID> -name <NODENAME>**.
15. Issue the **svcinfolnnode** command to verify that the node is online.

#### **Related tasks**

"Deleting a node from a cluster using the CLI" on page 222

You can delete a node from a cluster using the command line interface (CLI).

"Adding nodes to a cluster using the CLI" on page 181

You can add nodes to a cluster .

#### **Related reference**

“Configuring and servicing storage subsystems” on page 253

Follow the guidelines and procedures outlined in this section to make the most of the performance available from your storage subsystems and to avoid potential I/O problems.

## Recovering from offline VDIs after a node or an I/O group failed using the CLI

You can recover from an offline VDisk after a node or an I/O group has failed using the command-line interface (CLI).

If you have lost both nodes in an I/O group and have therefore, lost access to all the VDIs that are associated with the I/O group, then you must perform one of the following procedures to regain access to your VDIs. Depending on the failure type, you may have lost data that was cached for these VDIs, therefore, they have gone offline.

**Data loss scenario 1** One node in an I/O group failed and failover started on the second node. During this time, the second node in the I/O group fails before the data in the write cache has been written to disk. The first node is successfully repaired but its cache data is stale, therefore, it cannot be used. The second node is repaired or replaced and has lost its hard-end data, therefore, the node has no way of recognizing that it is part of the cluster.

Perform the following steps to recover from an offline VDisk:

1. Recover the node and include it back into the cluster.
2. Move all the offline VDIs to the recovery I/O group.
3. Move all the offline VDIs back to their original I/O group.

**Data loss scenario 2** Both nodes in the I/O group have failed and have been repaired. The nodes have lost their hard-end data, therefore, the nodes have no way of recognizing that they are part of the cluster.

1. Move all the offline VDIs to the recovery I/O group
2. Move both recovered nodes back into the cluster
3. Move all the offline VDIs back to their original I/O group.

### Related tasks

“Recovering a node and including it back into the cluster”

You can recover a node and including it back into the cluster using the command-line interface (CLI).

“Moving offline VDIs to the recovery I/O group” on page 212

You can move offline VDIs to the recovery I/O group using the command-line interface (CLI).

“Moving offline VDIs to their original I/O group using the CLI” on page 212

You can move offline VDIs to their original I/O group using the command-line interface (CLI).

## Recovering a node and including it back into the cluster

You can recover a node and including it back into the cluster using the command-line interface (CLI).

After a node or an I/O group fails, you can use the following procedure to recover a node and include it back into the cluster.

Perform the following steps to recover a node and include it back into the cluster:



1. Verify that the node is offline. Issue the following command:

```
svcinfolsnode
```

2. Remove the old instance of the offline node from the cluster. Issue the following command:

```
svctask rmnode <nodename/id>
```

where <NODENAME> is the name of the node.

3. Verify that the node can be seen on the fabric. Issue the following command:

```
svcinfolsnodecandidate
```

You should see the nodes listed as a candidate.

**Note:** Remember the WWNNs for each node, you will need it in the following step.

4. If the nodes are repaired by replacing the front panel module or a node is repaired by replacing it with another node, then the WWNN for the node will change. In this case, the following additional steps are required:
  - a. At the end of the recovery process it will be necessary to follow the SDD procedure to discover the new paths and to check that each vpath is now presenting the correct number of paths. See the *IBM TotalStorage Subsystem Device Driver: User's Guide* sections on dynamic reconfiguration, specifically adding paths to existing vpaths.
  - b. You may also need to modify the configuration of your disk controllers. If your controller uses a mapping technique to present its RAID arrays or partitions to the cluster you will need to modify the port groups that belong to the cluster because the WWNN or WWPN's of the node have changed.

**Attention:** If more than one I/O group is affected, ensure that you are adding the node to the same I/O group that it was removed from. Failure to do this can result in data corruption. Use the information that was recorded when the node was originally added to the cluster. This can avoid a possible data corruption exposure if the node must be removed from and re-added to the cluster. If you do not have access to this information, call IBM Service to add the node back into the cluster without corrupting the data.

**Attention:** If you are adding the node into the cluster for the first time, record the following information:

- Node serial number
- WWNN
- All WWPNs
- I/O group that contains the node

**Note:** This warning also is displayed on the SAN Volume Controller Console panel when adding the node.

5. Add the node back into the cluster. Issue the following command:

```
svctask addnode -wwnodename <WWNN> -iogrp  
<IOGRPNAME/ID> [-name <NODENAME>]
```

where <WWNN> is the worldwide node name <IOGRPNAME/ID> is the I/O group name or ID.

6. Verify that the node is online. Issue the following command:

```
svcinfolnode
```

### Related tasks

“Recovering from offline VDIs after a node or an I/O group failed using the CLI” on page 210

You can recover from an offline VDisk after a node or an I/O group has failed using the command-line interface (CLI).

## Moving offline VDIs to the recovery I/O group

You can move offline VDIs to the recovery I/O group using the command-line interface (CLI).

Perform the following steps to move offline VDIs to the recovery I/O group:

1. List all VDIs that are offline and belong to the I/O group in question. Issue the following command:

```
svcinfolsvdisk -filtervalue IO_group_name=  
<IOGRPNAME/ID>;status=offline
```

**Note:** <IOGRPNAME> = the name of the I/O group that failed.

2. For each VDisk returned, move the VDisk to the recovery I/O group. Issue the following command:

```
svctask chvdisk -iogrp recovery_io_grp -force  
<vdiskname/ID>
```

**Note:** <vdiskname/ID> = the name of one of the VDIs that are offline.

### Related tasks

“Recovering from offline VDIs after a node or an I/O group failed using the CLI” on page 210

You can recover from an offline VDisk after a node or an I/O group has failed using the command-line interface (CLI).

## Moving offline VDIs to their original I/O group using the CLI

You can move offline VDIs to their original I/O group using the command-line interface (CLI).

After a node or an I/O group fails, you can use the following procedure to move offline VDIs to their original I/O group.

**Attention:** Under no circumstances should VDIs be moved to an offline I/O group. Ensure the I/O group is online before moving the VDIs back to avoid any further data loss.

Perform the following steps to move offline VDIs to their original I/O group:

1. For each VDisk, move the VDisk back into the original I/O group. Issue the following command:

```
svctask chvdisk -iogrp <IOGRPNAME/ID> -force  
<vdiskname/ID>
```

**Note:** <IOGRPNAME> = the name of the I/O group that failed.

2. Verify that the VDIs are now online. Issue the following command:

```
svcinfolsvdisk -filtervalue IO_group_name=  
<IOGRPNAME/ID>
```

**Note:** <vdiskname/ID> = the name of one of the VDIsks that are offline.

#### **Related tasks**

“Recovering from offline VDIsks after a node or an I/O group failed using the CLI” on page 210

You can recover from an offline VDisk after a node or an I/O group has failed using the command-line interface (CLI).

## **Replacing an HBA in a host using the CLI**

You can replace an HBA in a host using the command-line interface (CLI).

This procedure describes how to notify the SAN Volume Controller of a change to a defined host object. It is sometimes necessary to replace the HBA that connects the host to the SAN, at this time you must notify the SAN Volume Controller of the new WWPN's that this HBA contains.

Ensure that your switch is zoned correctly.

Perform the following steps to replace an HBA in a host using the CLI:

1. Issue the following command to list the candidate HBA ports:

```
svcinfolshbaportcandidate
```

You should see a list of the HBA ports that are available to be added to host objects. One or more of these should correspond with the one or more WWPNs that belong to the new HBA.

2. Locate the host object that corresponds with the host in which you have replaced the HBA. The following command lists all the defined host objects:

```
svcinfolshost
```

To list the WWPNs currently assigned to the host, issue the following:

```
svcinfolshost <hostobjectname>where <hostobjectname>  
is the name of the host object.
```

3. Add the new ports to the existing host object by issuing the following command:

```
svctask addhostport -hbawwpn <one or more existing WWPNs  
separated by :> <hostobjectname/ID>
```

4. Remove the old ports from the host object by issuing the following command:

```
svctask rmhostport -hbawwpn <one or more existing WWPNs  
separated by :> <hostobjectname/ID>
```

where <one or more existing WWPNs separated by :> correspond with those listed in step 2 that belong to the old HBA that has been replaced.

5. Any mappings that exist between the host object and VDIsks will automatically be applied to the new WWPNs. Therefore, the host should see the VDIsks as the same SCSI LUNs as before.
6. See the *IBM TotalStorage Subsystem Device Driver: User's Guide* for additional information about dynamic reconfiguration.

#### **Related reference**

“Configuring and servicing storage subsystems” on page 253

Follow the guidelines and procedures outlined in this section to make the most of the performance available from your storage subsystems and to avoid potential I/O problems.

## Expanding VDisks

You can expand a VDisk from the Expanding VDisks panel or by using the command-line interface (CLI).

This topic lists the supported platforms and requirements if this feature is to be used

A VDisk that is not yet mapped to any hosts and hence does not contain any customer data can be expanded at any time. However, if the VDisk contains data that is being used, only AIX and Windows 2000 hosts can cope with a VDisk being expanded.

The following matrix shows the supported platforms and requirements if this feature is to be used:

*Table 16. Supported platforms and requirements*

Platform	Supported	Requirement
AIX	Yes	AIX 5.2 onwards only
HP-UX	No	
Linux	No	
SUN Solaris	No	
Windows NT	No	
Windows 2000, 2003	Yes	

### Related tasks

“Expanding a virtual disk that is mapped to an AIX host”

You can expand a virtual disk (VDisk) that is mapped to an AIX host.

“Expanding a virtual disk that is mapped to a Windows 2000 host” on page 215

You can expand a virtual disk (VDisk) that is mapped to a Windows 2000 host.

### Expanding a virtual disk that is mapped to an AIX host

You can expand a virtual disk (VDisk) that is mapped to an AIX host.

VDisks that are in participating in Flash Copy mappings or in Remote Copy relationships cannot be expanded.

Determine the exact size of the source or master VDisk by issuing the following command-line interface (CLI) command:

```
svcinfo lsvdisk -bytes <vdiskname>
```

This feature can be used in two ways:

- To increase the capacity available on a particular VDisk that is already mapped to a host.
- To increase the size of a VDisk so that it matches the size of the source or master VDisk and can be used in a FlashCopy mapping or Remote Copy relationship.

Perform the following steps to expand a VDisk that is mapped to an AIX host:

1. Determine the VDisk you wish to expand and remember its <vdiskname>.
2. Verify that this VDisk is mapped to an AIX host.
3. Determine the volume group that contains the VDisk (you must know the VDisk to hdisk relationship)
4. Quiesce all I/O operations to **all** volumes that belong to the volume group and sync the file-systems mounted on this volume group.
5. Check the current type of the VDisk by viewing the VDisk details in the Work with VDisks panel.

**Note:**

- a. If the VDisk has a type of image, it cannot be expanded.
  - b. If the VDisk has a type of sequential, it becomes a striped VDisk when you expand it.
6. Deactivate the volume group that contains this VDisk. Issue the following command from the command prompt:  
`varyoffvg <volume_group>`
  7. Expand the VDisk using either of the following methods:
    - a. From the Work with VDisks panel, select the VDisk and select the Expand task. Enter the capacity by which you wish to extend this VDisk and the select the appropriate units. Select one, more, or all of the MDisks from the list. These will be the MDisks that provide the extra capacity. Optionally, select the format check-box if you want this extra capacity to be formatted before use.
    - b. From the command prompt issue the following command:  
`svctask expandvdisksize`
  8. Reactivate the volume group so that the change in size is detected by the HBA device driver. Issue the following command from the command prompt:  
`varyonvg <volume_group>`
  9. Run the **change volume group** command to notify the LVM that the size has changed. Issue the following command from the command prompt:  
`chvg -g <volume_group>`
  10. Expand all the file-systems that are mounted on this VDisk (or use the new capacity as required)

Restart I/O operations to the volume group.

## **Expanding a virtual disk that is mapped to a Windows 2000 host**

You can expand a virtual disk (VDisk) that is mapped to a Windows 2000 host.

Vdisks that are in participating in Flash Copy mappings or in Remote Copy relationships cannot be expanded.

Ensure that you have run Windows Update and have applied all recommended updates to your system prior to attempting to expand a VDisk that is mapped to a Windows 2000 host

Determine the exact size of the source or master VDisk by issuing the following command-line interface (CLI) command:

```
svcinfo lsvdisk -bytes <vdiskname>
```

This feature can be used in two ways:

- To increase the capacity available on a particular VDisk that is already mapped to a host.
- To increase the size of a VDisk so that it matches the size of the source or master VDisk and can be used in a FlashCopy mapping or Remote Copy relationship.

VDisks can be expanded under Windows 2000 concurrently with I/O operations.

Perform the following steps to expand a VDisk that is mapped to a Windows 2000 host:

1. Expand the VDisk using either of the following methods:
  - a. From the Work with VDisks panel, select the VDisk and select the Expand task. Enter the capacity by which you wish to extend this VDisk and then select the appropriate units. Select one, more, or all of the MDisks from the list. These will be the MDisks that provide the extra capacity. Optionally, select the format check-box if you want this extra capacity to be formatted before use.
  - b. From the command prompt issue the following command:  

```
svctask expandvdisksize
```
2. On the Windows Host, start the Computer Management application and open the Disk Management window under the Storage branch.

You will see the VDisk that you expanded now has some unallocated space at the end of the disk.

Dynamic disks can be expanded without stopping I/O operations in most cases. However, in some applications the operating system may report I/O errors. When this problem occurs, either of the following entries may be recorded in the System event log:

```
Event Type: Information
Event Source: dmio
Event Category: None
Event ID: 31
Description: dmio:
Harddisk0 write error at block ##### due to
disk removal
```

```
Event Type: Information
Event Source: dmio
Event Category: None
Event ID: 34
Description: dmio:
Harddisk0 is re-online by PnP
```

**Attention:** This is a known problem with Windows 2000 and is documented at the Microsoft knowledge base as article Q327020. If either of these errors are seen, run Windows Update and apply the recommended fixes to resolve the problem.

Restart the Computer Management application if it was opened prior to expanding the VDisk.

If the disk is a Windows basic disk you can create a new primary or extended partition from the unallocated space.

If the disk is a Windows dynamic disk you can use the unallocated space to create a new volume (simple, striped, mirrored) or add it to an existing volume.

### Related concepts

“Virtual disks” on page 26

A *VDisk* is a logical disk that the cluster presents to the storage area network (SAN).

## Shrinking a VDisk using the CLI

You can shrink a VDisk using the command-line interface (CLI).

VDisks can be reduced in size should it be required. However, if the VDisk contains data that is being used, **under no circumstances should you attempt to shrink a VDisk without first backing up your data**. The SAN Volume Controller arbitrarily reduces the capacity of the VDisk by removing a partial, one or more extents from those allocated to the VDisk. You cannot control which extents are removed and so you cannot guarantee that it is unused space that is removed.

**Attention:** This feature should *only* be used to make a target or auxiliary VDisk the same size as the source or master VDisk when creating FlashCopy mappings or Remote Copy relationships. You should also ensure that the target VDisk is not mapped to any hosts prior to performing this operation.

Perform the following steps to shrink a VDisk:

1. Validate that the VDisk is not mapped to any host objects. If the VDisk is mapped, data is displayed.
2. You can determine the exact capacity of the source or master VDisk. Issue the following command:

```
svcinfolsvdisk -bytes <vdiskname>
```

3. Shrink the VDisk by the required amount. Issue the following command:

```
svctask shrinkvdisksize -size <capacitytoshrinkby> -unit  
<unitsforreduction> <vdiskname/ID>
```

## Migrating extents using the CLI

To improve performance, you can migrate extents using the command-line interface (CLI).

The SAN Volume Controller provides various data migration features. These can be used to move the placement of data both *within* MDisk groups and *between* MDisk groups. These features can be used concurrent with I/O operations. There are two ways in which you can migrate data:

1. Migrating data (extents) from one MDisk to another (within the same MDisk group). This can be used to remove hot or overutilized MDisks.
2. Migrating VDisks from one MDisk group to another. This can be used to remove hot MDisk groups, for example, reduce the utilization of a group of MDisks.

You can determine the usage of particular MDisks by gathering I/O statistics about MDisks and VDisks. Once you have gathered this data, you can analyze it to determine which MDisks are hot. The procedure then takes you through querying and migrating extents to elsewhere in the same MDisk group. This procedure can only be performed using the command line tools.

To migrate extents to remove possible problems, perform the following:

1. Isolate any MDisks that are overutilized. You can determine this by requesting an I/O statistics dump and analyzing the output. To start I/O statistics gathering, issue the following:

```
svctask startstats -interval 15
```

2. This will generate a new I/O statistics dump file approximately every 15 minutes. Wait for at least 15 minutes after issuing the **svctask startstats** command and then issue the following:

```
svcinfolsiostatsdumps
```

This will list the I/O statistics files that have been generated. These are prefixed with *m* and *Nm* for MDisk statistics and *v* for VDisk statistics.

3. Use secure copy (*scp*) to retrieve the dumps files to analyze. For example, issue the following:

```
<AIX HOST PROMPT#>scp <clusterip>:/dumps/iostats/m_*
```

This will copy all the MDisk statistics files to the AIX host in the current directory.

4. Analyze the dumps to determine which MDisks are hot. It may be helpful to also determine which VDIsks are being heavily utilized as you can spread the data they contain more evenly across all the MDisks in the group using the procedure below.
5. Stop the statistics collection again by issuing the following command:

```
svctask stopstats
```

Once you have determined which MDisks are hot, you can migrate some of the data onto some less hot MDisks within the same MDisk group.

1. Determine the number of extents that are in use by each VDisk for the given MDisk. Issue the following command:

```
svcinfolsmdiskextent <mdiskname>
```

This will return the number of extents that each VDisk is using on the given MDisk. You should pick some of these to migrate elsewhere in the group.

2. Determine the other MDisks that reside in the same MDisk group.
  - a. To determine the MDisk group that the MDisk belongs to, issue the following command:

```
svcinfolsmdisk <mdiskname/ID>
```

Look for the *mdisk\_grp\_name* attribute.

- b. List the MDisks in the group by issuing the following command:

```
svcinfolsmdisk -filtervalue mdisk_grp_name=<mdiskgrpname>
```

3. Select one of these MDisks as the target MDisk for the extents. You can determine how many free extents exist on an mdisk by issuing the following command:

```
svcinfolsfreeextents <mdiskname>
```



You can issue the **svcinfolsmdiskextent <newmdiskname>** command for each of the target MDisks to ensure that you are not just moving the over-utilization to another MDisk. Check that the VDisk that owns the set of extents to be moved, (see step 1 on page 218), does not already own a large set of extents on the target MDisk.

4. For each set of extents, issue the following command to move them to another MDisk:

```
svctask migrateextents -source <mdiskname/ID> -exts
<num_extents_from_step1> -target <newmdiskname/ID>
-threads 4 <vdiskid_returned_from_step1>
```

where *<num\_extents\_from\_step1>* is the number of extents on the *<vdiskid\_returned\_from\_step1>*, that is, the data that is returned from the command issued in step 1 on page 218. *<newmdiskname/ID>* is the name or ID of the MDisk to which you want to migrate this set of extents.

5. Repeat steps 2 on page 218 to 4 for all the sets of extents you wish to move.
6. You can check the progress of the migration(s) by issuing the following command:

```
svcinfolsmigrate
```

#### **Related tasks**

“Migration methods” on page 129

There are several methods to choose from when migrating image mode VDIs into managed mode VDIs.

## **Migrating VDIs between MDisk groups using the CLI**

You can migrate VDIs between MDisk groups using the command-line interface (CLI).

You can determine the usage of particular MDisks by gathering I/O statistics about MDisks and VDIs. Once you have gathered this data, you can analyze it to determine which VDIs or MDisks are hot. This procedure then takes you through migrating VDIs from one MDisk group to another.

When a migrate command is issued, a check is made to ensure that the destination of the migrate has enough free extents to satisfy the command. If it does, the command proceeds, but will take some time to complete. During this time, it is possible for the free destination extents to be consumed by another process, for example, by creating a new VDisk in the destination MDisk group or by starting more migrate commands. In this scenario, when all the destination extents have been allocated the migration commands suspend and an error is logged (error id 020005). There are two methods for recovering from this situation:

1. Add additional MDisks to the target MDisk group. This provides additional extents in the group and allows the migrations to be restarted. You will need to mark the error as fixed in order to reattempt the migration.
2. Migrate one or more VDIs that are already created from the MDisk group to another group. This will free up extents in the group and allow the original migrations to be restarted (again by marking the error as fixed).

Perform the following steps to migrate VDIs between MDisk groups:

1. Isolate any VDisks that are overutilized. You can determine this by requesting an I/O statistics dump and analyzing the output. To start I/O statistics gathering, issue the following command:

```
svctask startstats -interval 15
```

2. This will generate a new I/O statistics dump file approximately every 15 minutes. Wait for at least 15 minutes after issuing the **svctask startstats** command and then issue the following command:

```
svcinfolsiostatsdumps
```

This will list the I/O statistics files that have been generated. These are prefixed with m and Nm for MDisk statistics and v for VDisk statistics.

3. Use secure copy (scp) to retrieve the dumps files for analyzing. For example, issue the following:

```
<AIX HOST PROMPT#>scp <clusterip>:/dumps/iostats/v_*
```

This will copy all the VDisk statistics files to the AIX host in the current directory.

4. Analyze the dumps to determine which VDisks are hot. It may be helpful to also determine which MDisks are being heavily utilized as you can spread the data they contain more evenly across all the MDisks in the group by migrating the extents.
5. Stop the statistics collection again. Issue the following command:

```
svctask stopstats
```

Once you have analyzed the I/O statistics data, you can determine which VDisks are hot. You also need to determine which MDisk group you wish to move this VDisk to. Either create a new MDisk group or determine an existing group that is not yet over utilized. You can do this by checking the I/O statistics files generated above and ensuring that the MDisks or VDisks in the target MDisk group are less utilized than the source group.

6. After having determined which VDisk you wish to migrate, and the new MDisk group you wish to migrate it to, issue the following command:

```
svctask migratevdisk -vdisk <vdiskname/ID> -mdiskgrp  
<newmdiskgrname/ID> -threads 4
```

7. You can check the progress of the migration by issuing the following command:

```
svcinfolsmigrate
```

## Migrating a VDisk between I/O groups using the CLI

Ensure that you are familiar with migrating a VDisk between I/O groups.

**Attention:** These migration tasks are disruptive, in that the cached data held within the cluster must first be written to disk, then the allocation of the VDisk can be changed.

Modifying the I/O group that services the virtual disk cannot be done concurrently with I/O operations. It also requires a re-scan at the host level to ensure that SDD gets notified that the allocation of the preferred node has changed and the ports by which the virtual disk is accessed has changed. This should only be done in the situation where one pair of nodes has become over utilized.

Perform the following steps to migrate a VDisk between I/O groups:

1. Sync all file-systems that are mounted on the given virtual disk.
2. Stop all I/O operations to the virtual disk.
3. Type the following:

```
svctask chvdisk -iogrp <new_io_grp_name_or_id>  
<vdisk>
```

4. Issue the SDD command to resync the VDisk to host mapping. See the *IBM TotalStorage Subsystem Device Driver: User's Guide* for more information.
5. Restart the I/O operations to the virtual disk.

## Creating an image mode VDisk from an unmanaged MDisk using the CLI

The SAN Volume Controller enables you to import storage that contains existing data and continue to use this storage but make use of the advanced functions, such as, Copy Services, data migration, and the cache. These disks are known as image mode virtual disks.

Make sure you are aware of the following before converting your virtual disks:

1. Unmanaged disks that contain existing data cannot be differentiated from unmanaged disks that are blank. Therefore, it is vital that you control the introduction of these disks to the cluster. It is recommended that you introduce these disks one at a time. For example, map a single LUN from your RAID controller to the cluster and refresh the view of managed disks. The newly detected disk is displayed.
2. *Do not* add a unmanaged disk that contains existing data to a unmanaged disk group manually. If you do, the data will be lost. When you create an image mode virtual disk from this unmanaged disk, it will be automatically added to the unmanaged disk group. However, it will be added in such a way that the cluster can control how it is added to ensure the data is not lost.

Go to the following Web site for more information:

<http://www-1.ibm.com/servers/storage/support/virtual/2145.html>

If you wish to convert this virtual disk or managed disk to actually virtualize the storage, you can transform the image mode virtual disk into a striped virtual disk by migrating the data on the image mode disk to other managed disks in another MDisk group. This procedure can be performed using the command-line interface (CLI). Issue the **svctask migratevdisk** command to migrate an entire virtual disk from one managed disk group to another managed disk group.

Perform the following steps to convert your virtual disk from image mode to unmanaged mode:

1. Map a single RAID array or LUN from your RAID controller to the cluster. You can do this either through a switch zoning or a RAID controller based on your host mappings.
2. Re-scan the list of unmanaged disks from the SAN Volume Controller Console. Issue the **svcinfo lsmdisk** command to list the available unmanaged disks. Optionally, if the new unmanaged disk is not listed you may need to run a fabric level discovery. Issue the **svctask detectmdisk** command to manually re-scan the fibre-channel network for any new unmanaged disks that might have been added.

3. Convert the unmanaged disk into an image mode virtual disk. Issue the **svctask mkvdisk** command to create an image mode virtual disk object. Once mapped to a host object, these virtual disks are seen as disk drives with which the host can perform I/O operations.
4. Map the new virtual disk to the hosts that were previously using the data that the MDisk contains. Issue the **svctask mkvdiskhostmap** command to create a new mapping between a virtual disk and a host. That is, the virtual disk is made accessible for I/O operations to the specified host.

## Advanced function cluster overview using the CLI

The command-line interface (CLI) offers advanced functions for your cluster.

### Overview

The following sections detail the advanced cluster functions that you can perform using the CLI.

#### Related tasks

“Deleting a node from a cluster using the CLI”

You can delete a node from a cluster using the command line interface (CLI).

“Performing the cluster maintenance procedure using the CLI” on page 224

You can perform the cluster maintenance procedure using the command-line interface (CLI).

“Modifying IP addresses using the CLI” on page 224

You can modify IP addresses using the command-line interface (CLI).

“Maintaining SSH keys using the CLI” on page 225

You can maintain SSH keys using the command-line interface (CLI).

“Setting up error notifications using the CLI” on page 225

You can set up error notifications using the command-line interface (CLI).

“Modifying passwords using the CLI” on page 226

You can modify the admin and service passwords using the command-line interface (CLI).

“Listing log or dump files using the CLI” on page 226

You can list log or dump files using the command-line interface (CLI).

“Changing the language setting using the CLI” on page 227

You can change the language settings using the command-line interface (CLI).

“Viewing the feature log using the CLI” on page 228

You can view the feature log using the command-line interface (CLI).

“Analyzing the error log using the CLI” on page 228

You can analyze the error log using the command-line interface (CLI).

“Shutting down a cluster or single node using the CLI” on page 228

You can shut down a cluster using the command-line interface (CLI).

### Deleting a node from a cluster using the CLI

You can delete a node from a cluster using the command line interface (CLI).

**Attention:** Before you delete a node from the cluster, quiesce all I/O operations that are destined for this node. Failure to do so can result in failed I/O operations that are reported to your host operating systems.

**Attention:** If you are deleting a single node, and the other node in the I/O group is online, be aware that the cache on the partner node will go into write-through mode and that you are exposed to a single point of failure should the partner node fail.

If you are deleting a node, and this is the last node in the I/O group, you will lose access to all VDIs served by this I/O group. Ensure that all VDIs are not being accessed or contain data that you wish to continue to access, or ensure that they have been migrated to a different, online I/O group.

1. Begin by determining the VDIs that are still assigned to this I/O group:
  - a. Determine the VDIs in question by requesting a filtered view of VDIs where the filter attribute is the I/O group in question. This can be done using the following command:

```
svcinfolsvdisk -filtervalue IO_group_name=<name>
```

where <name> is the name of the I/O group in question.
  - b. Once you have a list of VDIs, determine the hosts that they are mapped to by following the procedure called, Determining the hosts that a VDI is mapped to.
  - c. Once you have determined the hosts and are sure that you do not wish to maintain access to these VDIs proceed to 3.
  - d. If you determine that some or all of the VDIs assigned to this I/O group do contain data that you wish to continue to access, you should follow the procedure called, Migrating a VDI to a new I/O group.
2. Before performing the SDD path removal procedure described in 3 you should power off the node that you intend to remove, unless this is the last node in the cluster. This ensures that SDD does not rediscover the paths that are manually removed before you issue the delete node request.

**Attention:** If the node being removed is the configuration node, it may take a minute or so before you can perform the delete node request as the configuration node failover has to occur. If the node being removed is the last node in the cluster, the SAN Volume Controller Console may appear to hang for up to 3 minutes because you have removed the last access point to the cluster. Removing the last node in the cluster destroys the cluster. Ensure that this is what you want to do before performing this task.

**Note:** If you power back on the node that has been removed and it is still connected to the same fabric or zone it will attempt to rejoin the cluster. At this point the cluster will tell the node to remove itself from the cluster and the node will become a candidate for addition to this cluster or another cluster. If you are adding this node back into the cluster, ensure that you add it back to the same I/O group that it was previously a member of. Failure to do so may result in data corruption.

3. Before deleting the node, it is essential that for each vpath presented by the VDIs you intend to remove, the SDD configuration is updated to remove the vpaths in question. Failure to do this may result in data corruption. See the *IBM TotalStorage Subsystem Device Driver: User's Guide* for details about how to dynamically re-configure SDD for the given host operating system.

Perform the following steps to delete a node:

1. Open a command prompt window.

**Note:**

- a. Before removing a node, be sure that this is what you want to do. All of the VDisks in the node will be assigned to the remaining node in the I/O group. That is, the preferred node will be changed. You cannot change this setting once this is done. Also, all VDisks will go into write-through cache mode because there is not a redundant node available to duplicate the cached information.
  - b. If this is the last node in the I/O group or the last node in the cluster, you will be prompted to force the deletion.
  - c. If this is the last node in the cluster or it is the configuration node, all connections to the cluster will be lost. The user interface and any open CLI sessions will become unavailable. This can result in a timeout from the command, because the command cannot be completed before the node is deleted.
2. Issue the **svctask rmnode** command to delete a node from the cluster. You can enter this command any time after a cluster has been created.

**Related reference**

“Advanced function cluster overview using the CLI” on page 222  
 The command-line interface (CLI) offers advanced functions for your cluster.

**Performing the cluster maintenance procedure using the CLI**

You can perform the cluster maintenance procedure using the command-line interface (CLI).

Perform the following steps for cluster maintenance:

1. Open a command prompt window.
2. Issue the **svctask finderr** command to analyze the error log for the highest severity of unfixed errors. This command scans the error log for any unfixed errors. Given a priority ordering defined within the code, the highest priority of unfixed errors is returned.
3. Issue the **svctask dumperrlog** command to dump the contents of the error log to a text file.
4. Locate the error and fix.
5. Issue the **svctask clearerrlog** command to clear all entries from the error log including status events and any unfixed errors.

**Note:** Clearing the error log will not fix the errors.

**Attention:** You should only use this command when you have either rebuilt the cluster, or have fixed a major problem that has caused many entries in the error log that you do not want to fix individually.

6. Issue the **svctask cherrstate** command to change the state of an error. The state can be changed from unfixed to fixed, or fixed to unfixed.

**Related reference**

“Advanced function cluster overview using the CLI” on page 222  
 The command-line interface (CLI) offers advanced functions for your cluster.

**Modifying IP addresses using the CLI**

You can modify IP addresses using the command-line interface (CLI).

Perform the following steps to modify IP addresses:

1. Open a command prompt window.
2. Issue the **svcinfo lscluster** command to list the IP address of the cluster.

3. Issue the **svctask chcluster** command to modify the IP address. This command enables you to change the settings for the following:
  - a. Cluster IP address
  - b. Subnet mask
  - c. Gateway

If you specify a new cluster IP address, the existing communication with the cluster is broken.

#### Related reference

“Advanced function cluster overview using the CLI” on page 222

The command-line interface (CLI) offers advanced functions for your cluster.

## Maintaining SSH keys using the CLI

You can maintain SSH keys using the command-line interface (CLI).

**Attention:** After you add a cluster, close the Maintaining SSH Keys panel.

Perform the following steps to maintain SSH keys:

1. Open a command prompt window.
2. Issue the **svcinfo lsshkeys** command to list the SSH keys that are available on the cluster.
3. Issue the **svctask addsshkey** command to install a new SSH key on the cluster. The key file must first be copied onto the cluster. Each key is associated with an ID string that you define that can consist of up to 30 characters. Up to 100 keys can be stored on a cluster. You can add keys to provide either administrator access or service access. For example, type the following:

```
svctask addsshkey -user service -file /tmp/id_rsa.pub -label testkey
```

where */tmp/id\_rsa.pub* is the name of the file that the SSH key will be saved in and *testkey* is the label to associate with this key.

4. You can issue the **svctask rmsshkey** command to remove an SSH key from the cluster.
5. You can issue the **svctask rmallsshkeys** command to remove all of the SSH keys from the cluster.

#### Related reference

“Advanced function cluster overview using the CLI” on page 222

The command-line interface (CLI) offers advanced functions for your cluster.

## Setting up error notifications using the CLI

You can set up error notifications using the command-line interface (CLI).

Perform the following steps to set up error notifications:

1. Open a command prompt window.
2. Issue the **svctask setevent** command to specify what you like to happen when an error or event is logged to the error log. You can select whether the cluster raises an SNMP trap, issues an e-mail notification for entries that are added to the cluster error or event log, or both. Three levels of notification are possible:
  - a. **None** No error or status changes will be sent.
  - b. **Hardware\_only** You will be notified of errors, but you will not be notified of status changes.
  - c. **All** You will be notified of all errors and status changes.

If you have an SNMP manager installed or if you want to be notified by e-mail of errors or events, you should enable error notification. The notification levels for SNMP and e-mail alerts can be set independently. If you choose **All** or **Hardware\_only** notification, you must select a destination for the notification.

#### **Related reference**

“Advanced function cluster overview using the CLI” on page 222

The command-line interface (CLI) offers advanced functions for your cluster.

## **Modifying passwords using the CLI**

You can modify the admin and service passwords using the command-line interface (CLI).

Passwords only affect access to the cluster via the SAN Volume Controller Console. To restrict access to the command line interface (CLI) you must control the list of SSH client keys installed on the cluster.

Perform the following steps to modify the passwords:

1. Open a command prompt window.
2. Issue the following command to change the administrator users password:

```
svtask chcluster -admpwd <admin_password>
```

3. Issue the following command to change the service users password:

```
svtask chcluster -servicepwd <service_password>
```

#### **Related tasks**

“Maintaining passwords using the CLI” on page 179

You can maintain passwords using the command-line interface (CLI).

#### **Related reference**

“Advanced function cluster overview using the CLI” on page 222

The command-line interface (CLI) offers advanced functions for your cluster.

## **Listing log or dump files using the CLI**

You can list log or dump files using the command-line interface (CLI).

Perform the following steps to list log or dump files:

1. Open a command prompt window.
2. You can issue any of the following commands to list error log files:
  - a. **svcinfolerrlogbydisk**
  - b. **svcinfolerrlogbydiskgroup**
  - c. **svcinfolerrlogbyvdisk**
  - d. **svcinfolerrlogbyhost**
  - e. **svcinfolerrlogbynode**
  - f. **svcinfolerrlogbyiogrp**
  - g. **svcinfolerrlogbyfcconsistgrp**
  - h. **svcinfolerrlogbyfcmap**
  - i. **svcinfolerrlogbyrcconsistgrp**
  - j. **svcinfolerrlogbyrcrelationship**

These commands will list the error log by type. These commands will return a list of dumps in the appropriate directory. For example, issue the **svcinfolerrlogbydisk** command, displays the error log by MDisk.



You can display the whole log or filter the log so that only errors, events, or unfixed errors are displayed. In addition, you can request the output to be sorted either by error priority or by time. For error priority, the most serious errors are the lowest-numbered errors. They are, therefore, displayed first in the table. For time, either the older or the latest entry can be displayed first in the output.

3. You can issue any of the following command to list dump files.
  - a. **svcinfolconfigdumps**
  - b. **svcinfolerrlogdumps**
  - c. **svcinfolfeaturedumps**
  - d. **svcinfoliostatsdumps**
  - e. **svcinfolsiotracedumps**
  - f. **svcinfolsoftwaredumps**
  - g. **svcinfol2145dumps**

These commands will list the dump file by type. These commands will return a list of dumps in the appropriate directory. For example, issue the **svcinfolconfigdumps** command, a list of dumps for configurations will be stored in the `/dumps/configs` destination directory.

The software dump files contain dumps of the SAN Volume Controller memory. Your service representative might ask for these dumps to debug problems. The software dumps are large files (approximately 300 MB). Consider copying these files to your host using secure copy (scp) methods.

#### **Related reference**

“Advanced function cluster overview using the CLI” on page 222

The command-line interface (CLI) offers advanced functions for your cluster.

## **Changing the language setting using the CLI**

You can change the language settings using the command-line interface (CLI).

Perform the following steps to change the language settings:

1. Open a command prompt window.
2. Issue the **svcservicetask setlocale** command to change the locale setting for the cluster. It changes all interfaces output to the chosen language. For example, if you wanted to change the English default language to Japanese, type the following:

```
svcservicetask setlocale -locale 3
```

where `3` is the argument that stands for Japanese. The arguments are:

- a. **0** US English (default)
- b. **1** Chinese (simplified)
- c. **2** Chinese (traditional)
- d. **3** Japanese
- e. **4** Korean
- f. **5** French
- g. **6** German
- h. **7** Italian
- i. **8** Spanish
- j. **9** Portuguese (Brazilian)

**Note:** This command does not change the front panel display panel settings.

### Related reference

“Advanced function cluster overview using the CLI” on page 222  
The command-line interface (CLI) offers advanced functions for your cluster.

## Viewing the feature log using the CLI

You can view the feature log using the command-line interface (CLI).

Perform the following steps to view the feature log:

1. Open a command prompt window.
2. Issue the **svcinfo lsfeaturedumps** command to return a list of dumps in the /dumps/feature destination directory. The feature log is maintained by the cluster. The feature log records events that are generated when license parameters are entered or when the current license settings have been breached.
3. Issue the **svcserviceinfo lsfeaturedumps** command to return a list of the files that exist of the type specified on the given node.

### Related reference

“Advanced function cluster overview using the CLI” on page 222  
The command-line interface (CLI) offers advanced functions for your cluster.

## Analyzing the error log using the CLI

You can analyze the error log using the command-line interface (CLI).

Perform the following steps to analyze the error log:

1. Open a command prompt window.
2. You can issue any of the following commands to list error log files:
  - a. **svcinfo lserrlogbymdisk**
  - b. **svcinfo lserrlogbymdiskgroup**
  - c. **svcinfo lserrlogbyvdisk**
  - d. **svcinfo lserrlogbyhost**
  - e. **svcinfo lserrlogbynode**
  - f. **svcinfo lserrlogbyiogrp**
  - g. **svcinfo lserrlogbyfcconsistgrp**
  - h. **svcinfo lserrlogbyfcmap**
  - i. **svcinfo lserrlogbyrcconsistgrp**
  - j. **svcinfo lserrlogbyrcrelationship**

These commands will list the error log by type. These commands will return a list of dumps in the appropriate directory. For example, issue the **svcinfo lserrlogbymdisk** command, displays the error log by MDisk.

You can display the whole log or filter the log so that only errors, events, or unfixed errors are displayed. In addition, you can request the output to be sorted either by error priority or by time. For error priority, the most serious errors are the lowest-numbered errors. They are, therefore, displayed first in the table. For time, either the older or the latest entry can be displayed first in the output.

### Related reference

“Advanced function cluster overview using the CLI” on page 222  
The command-line interface (CLI) offers advanced functions for your cluster.

## Shutting down a cluster or single node using the CLI

You can shut down a cluster using the command-line interface (CLI).

If all input power to a SAN Volume Controller cluster is to be removed for more than a few minutes, (for example, if the machine room power is to be shutdown for maintenance), it is important that the cluster is shutdown before the power is removed. The reason for this is that if the input power is removed from the uninterruptible power supply units without first shutting down the cluster and the uninterruptible power supplies, the uninterruptible power supply units will remain operational and eventually become drained of power.

When input power is restored to the uninterruptible power supplies they will start to recharge but the SAN Volume Controllers will not permit any I/O activity to be performed to the virtual disks until the uninterruptible power supply is charged enough to enable all the data on the SAN Volume Controller nodes to be saved in the event of an unexpected power loss. This might take as long as three hours. Shutting down the cluster prior to removing input power to the uninterruptible power supply units will prevent the battery power being drained and will make it possible for I/O activity to be resumed as soon as input power is restored.

### Shutting down the cluster

Before shutting down a node or the cluster you should quiesce all I/O operations that are destined for this node or cluster. Failure to do so may result in failed I/O operations being reported to your host operating systems.

**Attention:** If you are shutting down the entire cluster, you will lose access to all VDisks being provided by this cluster. Shutting down the cluster will also shut down all nodes. This shutdown will cause the hardened data to be dumped to the internal hard drive.

**Attention:** Ensure that you have stopped all FlashCopy, Remote Copy and data migration operations before you attempt a node or cluster shutdown. Also ensure that all asynchronous deletion operations have completed prior to a shutdown operation.

Begin the process of quiescing all I/O to the cluster by stopping the applications on your hosts that are using the VDisks provided by the cluster.

1. If you are unsure which hosts are using the VDisks provided by the cluster, follow the procedure called, Determining the hosts that a VDisk is mapped to.
2. Repeat the previous step for all VDisks.

Perform the following steps to shut down a cluster:

1. Begin the process of quiescing all I/O to the cluster by stopping the applications on your hosts that are using the VDisks provided by the cluster.
  - a. If you are unsure which hosts are using the VDisks provided by the cluster, follow the procedure called, Determining the hosts that a VDisk is mapped to.
  - b. Repeat the previous step for all VDisks.
2. Open a command prompt window.
3. When all I/O has been stopped, issue the **svctask stopcluster** to shut down a single node or the entire cluster in a controlled manner. If you specify the node ID or node name, you can shut down a single node.

When you enter this command, you will need to either specify a node ID or node name argument, the node in question is to be shut down. After the command completes, the other node in the I/O group de-stages the contents of

its cache and goes into write-through mode until the power to the node is returned and the node rejoins the cluster.

**Attention:** If this is the last node in an I/O group, you will lose all access to the virtual disks in the I/O group. Before you enter this command, ensure that this is what you want to do. You must specify the force flag.

If a shutdown command has been sent to the cluster and both cluster and uninterruptible power supply units have powered off, when input power is restored it will be necessary to restart the uninterruptible power supply units by pressing the power button on the uninterruptible power supply front panel.

4. Close the SSH session if you are using SSH in interactive mode.

### Shutting down a single node

**Attention:** If you are shutting down a single node, and the other node in the I/O group is online, be aware that the cache on the partner node will go into write-through mode and that you are exposed to a single point of failure should the partner node fail while this node is shut down. Proceed to 2

**Attention:** If you are shutting down a single node, and this is the last node in the I/O group, you will lose access to all VDisks being served by this I/O group.

Perform the following steps to shut down a single node:

1. Begin the process of quiescing all I/O to the VDisks being served by this nodes I/O group.
  - a. Determine the VDisks in question by requesting a filtered view of VDisks where the filter attribute is the I/O group in question. This can be done using the following command: `svcinfolsvdisk -filtervalue I0_group_name=<name>` where <name> is the name of the I/O group in question.
  - b. Once you have a list of VDisks, determine the hosts that these are mapped to by following the procedure called, Determining the hosts that a VDisk is mapped to.
2. When all I/O has been stopped issue the following command to shut down the node: `svctask stopcluster <nodename/ID>` where <nodename/ID> is the name or ID of the node that you want to shut down.

**Note:** If this is the last node in the I/O group you also need to specify the -force parameter. For example to force the shutdown of node1: `svctask stopcluster -force node1`

### Related tasks

“Determining the host that a VDisk is mapped to” on page 202

You can determine the host that a VDisk is mapped to using the command-line interface (CLI).

### Related reference

“Advanced function cluster overview using the CLI” on page 222

The command-line interface (CLI) offers advanced functions for your cluster.

---

## Chapter 5. Backing up and restoring the cluster configuration

You can back up and restore the cluster configuration.

Maintaining your cluster configuration involves several tasks. This topic lists the tasks that are involved.

- Backing up the cluster configuration
- Restoring the cluster configuration
- Deleting unwanted backup configuration files

### Related tasks

“Backing up the cluster configuration”

To back up a cluster configuration, complete these tasks.

“Restoring the cluster configuration” on page 234

You can restore a cluster configuration by using the Restoring a Cluster Configuration panel in the SAN Volume Controller Console or the **svconfig** command in the command-line interface (CLI).

“Deleting a backup configuration file” on page 238

You can delete a backup cluster configuration by using the Deleting a Cluster Configuration panel or the command-line interface (CLI) **SVCCONFIG** command.

---

### Backing up the cluster configuration

To back up a cluster configuration, complete these tasks.

Plan to regularly back up the business data that is stored on all VDisks using your preferred backup method. It is important that the data on all VDisks is backed up, because it will be lost when the configuration is restored.

- All nodes must be online.
- No object name may begin with an underscore.
- All objects should have non-default names, that is, names that are not assigned by the SAN Volume Controller.

**Note:** While it is recommended that objects have non-default names at the time the backup is taken, this is not mandatory. Objects with default names will be renamed when they are restored. The names will appear in the format *name\_r*.

The following scenario illustrates the value of configuration backup:

1. Use the Backing up a Cluster Configuration panel in the master console or the **svconfig** command to create a backup file on the cluster that contains details of the current cluster configuration.
2. Store the backup configuration on some form of tertiary storage.

**Note:** You must copy the backup file off the cluster or it will be lost if the cluster crashes.

3. If a severe failure occurs, it will cause the cluster to be lost. Both configuration data (for example, the cluster definitions of hosts, I/O groups, managed disk groups, MDisks) and the application data on the virtualized disks is lost. In this scenario, it is assumed that the application data can be restored from normal customer backup procedures. However, before this can be carried out, it is

necessary to reinstate the cluster, as configured at the time of the failure. This means restoring the same managed disk groups, I/O groups, host definitions, and finally the VDIs that existed prior to the failure. The application data can then be copied back onto these VDIs and operations resumed.

4. Recover the hardware: hosts, SAN Volume Controllers, disk controller systems, disks, and SAN fabric. The hardware and SAN fabric must physically be the same as that used before the failure.
5. Re-initialize the cluster.
6. Restore your cluster configuration using the backup configuration file generated in step 1 on page 231
7. Restore the data on your virtual disks (VDIs) using your preferred restore solution, or with help from IBM Service.
8. Resume normal operations.

**Restrictions:** The following restrictions must be observed for the scenario described above, or for a similar scenario, to work:

- The installed hardware must be identical when the backup is taken and when the restore is done. Otherwise the restore will fail.
- No changes should be made to the fabric or the cluster between backup and restore. If changes are made, you should back up your cluster configuration again.
- There are two phases in the restore process, prepare and execute. Do not make any changes to the fabric or the cluster between the two phases.
- No independent operations that could change the cluster configuration should be running while the backup command is running.

Perform the following steps to backup your cluster configuration.

1. Back up the data that your enterprise uses to run its business using your preferred backup method. It is important that the data on all VDIs is backed up, because it will be lost when the configuration is restored.
2. Back up the cluster configuration using the Backing Up a Cluster Configuration panel or the **svconfig backup** command.

**Note:** Back up the cluster configuration immediately after completing step 1.

3. Ensure that all your SSH keys are available. You need these keys when you restore the cluster configuration.

When the **svconfig backup** command runs, it produces a file called `svc.config.backup.xml`, which describes the cluster configuration. This file is stored in `/tmp` on the configuration node within the cluster. It is important that this file is copied from the cluster to some external storage since, should the configuration node move to another node within the cluster, then the `/tmp` directory on this node will be inaccessible. (The configuration node might move in response to an error recovery action, or due to some user maintenance activity.)

To copy the `svc.config.backup.xml` from the node to external storage, use the secure copy command (`pscp`) on the master console or the secure copy command as described in the example below if you accessing the cluster through your own secure shell installation.

The backup feature of the **svconfig** command is designed to back up the cluster information, such as VDIs, local Remote Copy information, MDisk groups, and nodes and not the information that you have written to the VDIs within the cluster.

It is important that any application using the VDisks on the cluster as storage should back up its data as usual using their appropriate backup routines.

All nodes must be online and no object in the cluster can begin with an underscore "\_".

To create a backup of your cluster configuration, (*your\_cluster\_name*), perform the following steps:

1. Log onto the cluster by issuing the following:

```
ssh -l admin your_cluster_name -p 22
```

This will bring up a session on the cluster where you can issue the **svconfig** command.

2. Issue the following:

```
svconfig clear -all
```

This will remove any existing backup files that are on your cluster and ensure a clean directory into which the backup files can be placed.

3. Issue the following:

```
svconfig backup
```

The cluster will return output similar to the following as the backup runs:

```
CMMVC6112W mdisk mdisk14 ...
CMMVC6112W node node1 ...
CMMVC6112W node node2 ...
```

Once the backup has completed and you have returned to the prompt, you will need to exit the cluster and copy the backup files to somewhere off the cluster.

4. Issue the following:

```
exit
```

5. To copy the backup files off the cluster, issue the following:

```
scp -P 22 admin@your_cluster:/tmp/svc.config.backup.*
/offclusterstorage/
```

The following three files will be retrieved from the cluster:

- a. *svc.config.backup.xml* This contains the information about the objects on your cluster.
- b. *svc.config.backup.sh* This contains the **svconfig** commands that were used to create the backup of the cluster.
- c. *svc.config.backup.log* This contains the feedback from the backup routine and will contain any error information that may have been reported.

Because the **svconfig** command requires that the same cluster configuration be in place before you can restore, it is wise to rename these files with the configuration node name either at the start or end of the file names to make identification easier at restore time. To rename the files with the configuration node name, issue the following:

```
mv /offclusterstorage/svc.config.backup.xml
/offclusterstorage/svc.config.backup.xml_myconfignode
```

Because these files contain details about your cluster, it is advisable to copy them to a location that is under password control to avoid unauthorized access to this configuration information.

---

## Restoring the cluster configuration

You can restore a cluster configuration by using the Restoring a Cluster Configuration panel in the SAN Volume Controller Console or the **svcconfig** command in the command-line interface (CLI).

**Note:** Data is **NOT** restored when restoring a configuration from backup. Ensure that you rely on restoring data from traditional data backups once you have restored the cluster configuration.

Ensure that the cluster to which you are restoring the backup configuration files meet the following conditions:

- You have a copy of your configuration files on a server accessible to the cluster (for example, the master console).

**Note:** Ensure that you back up the cluster configuration to generate the configuration files.

- You can download the configuration files to your master console by performing the following steps:
  1. Log onto the SAN Volume Controller Admin Console.
  2. Click **Service and Maintenance -> List Dumps**.
  3. Click **Software Dumps**. The Software Dump files window is displayed.
  4. Find the configuration files on the Software Dump files window and download them to your master console.

**Attention:** When saving the configuration files, ensure that you select the All Files option from the drop-down list.

- The installed hardware must be identical when the backup is taken and when the restore is done. Otherwise the restore will fail. All nodes, controllers and MDisks must be the same. It is permissible to have replaced one or more nodes, provided they present the correct WWNN identifiers. The fabric of the SAN should also be identical.
- The restore must be performed to a single node cluster. The single node cluster must be the node that was the configuration node at the time that the backup was taken. You can use the same naming convention as described above. All other nodes (or the other single node for a two-node cluster) that were part of the cluster at the time that the backup was taken, must be powered on but not configured to the cluster. These nodes should appear as output from issuing the **svcinfolnodecandidate** command or by using the SAN Volume Controller Console.

In addition, the SAN Volume Controller analyzes the backup configuration file and the cluster to see if all of the following conditions are true:

- Both cluster names match. This is case sensitive.
- All of the MDisks and subsystems that were configured at the time that the configuration backup was taken are present.
- All required disk controller systems are available.



- The featurization settings match. Ensure that you obtain featurization settings from within the SAN Volume Controller Admin Console before proceeding with the configuration restoration below. Perform the following steps to obtain the featurization settings:
  1. Log onto the SAN Volume Controller Admin Console.
  2. Click **Service and Maintenance -> Set Features**.

**Note:** Take note of the Virtualization Limit (Gigabytes) for you will need it later. Also take note of whether FlashCopy and Remote Copy re Enabled or Disabled.

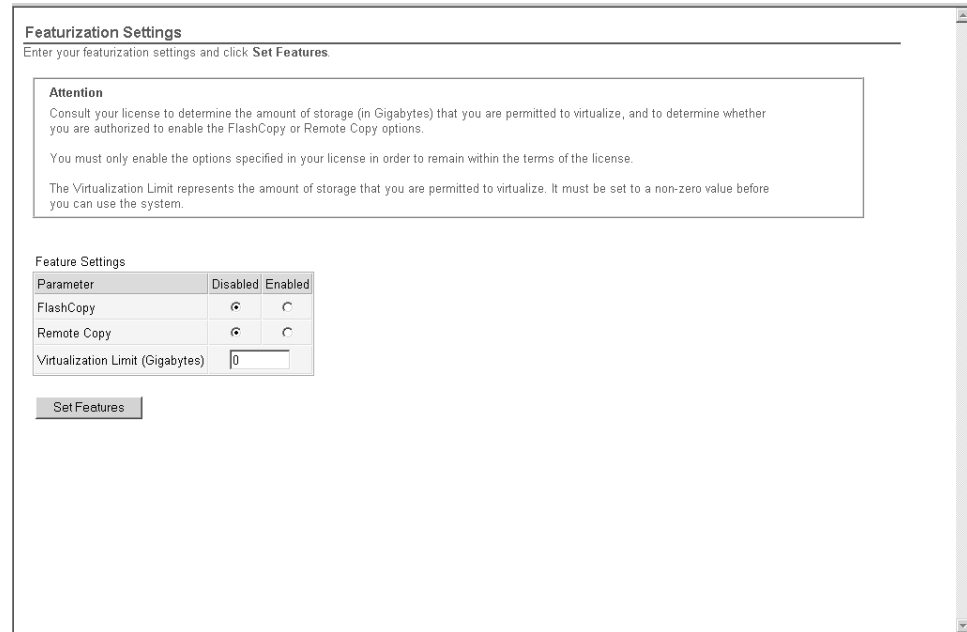

Figure 44. Featurization settings

Before you begin, hardware recovery must be complete. In particular, the following hardware must be operational: hosts, SAN Volume Controllers, disk controller systems, disks, and the SAN fabric.

**Attention:** Before removing the cluster, ensure that you have a copy of the cluster and all of its data stored somewhere safe. Also, ensure you have a list of the following Featurization values:

- Virtualization limit
- FlashCopy Enabled\Disabled
- Remote Copy Enabled\Disabled

To restore a cluster configuration, complete these tasks.

1. Perform the following steps to prepare the cluster for configuration restore by removing the cluster using the front panel and using the SAN Volume Controller Console:

**Attention:** Before removing the cluster, ensure that you have a copy of the cluster and all of its data stored somewhere safe. Also, the following procedure requires that you have Superuser administrator authority.

- a. Select delete cluster from the front panel on each node in the cluster.

**Note:** Do this for all nodes that are not showing *Cluster* : on the front panel. This means they are already destroyed and are candidates.

- b. Click **Clusters** in the portfolio. The View Clusters panel is displayed.
  - c. Select the cluster you want to remove and select **Remove a cluster** from the list. Click **Go**.
2. Create a new cluster from the front panel.
  3. Add the cluster using the Adding clusters panel.
  4. Connect to the cluster by either using the CLI or the SAN Volume Controller Console. Type the IP address of the cluster and select the Create (Initialize) Cluster check box. When you click OK, the Create a Cluster wizard is displayed.
  5. Configure the cluster. During the configuration wizard, the Featurization settings window asks for the feautrization settings. Ensure that you enter the same values for these features that you noted previously.

**Note:** You should now be able to connect to the cluster via the SAN Volume Controller Console or the CLI. The PuTTY or SSH keys have been uploaded. You may need to reset the SSH keys after uploading the public key.

6. Copy the file named `svc.config.backup.xml` to the `/tmp` directory of the cluster using the PuTTY "pscp" program from the master console. Perform the following steps to use the PuTTY "pscp" program and copy the file:
  - a. Open a command prompt from the master console.
  - b. Set the path in the command line to use pscp with the following format: `set PATH=C:\path\to\putty\directory;%PATH%`
  - c. Issue the following command to specify the location of your private SSH key for authentication. `pscp [options] source [source...] [user@]host:target`
7. Prepare the cluster using the **svconfig restore -prepare** command. After issuing this command, do not rename the objects in the cluster. The default names are required to successfully complete the restoration. The unique names in the backup configuration file will be restored at the completion of the restoration.

**Note:** Copy the output log file to another server accessible to the cluster (the master console) and check for errors. If there are errors, correct the condition which caused the errors and reissue the command. Ensure that you correct all errors before proceeding. If you need assistance, contact IBM Customer Support. Perform the following steps to copy the log file:

- a. Issue the **pscp -i <private key location> [user@]host:source target**
  - b. The file name is `/tmp/svc.config.restore.prepare.log`
8. Restore the cluster configuration using the **svconfig restore -execute** command. Issuing the **svconfig restore -execute** command on a single node cluster will add the other nodes and hosts to the cluster. This will create a log file named `svc.config.restore.execute.log` in the `/tmp` directory. Check this log to ensure that no errors or unexpected warnings have been located.

**Note:** In some cases, you may receive an error or warning stating that a featurization has not been enabled. This means that the current featurization values did not match the previous featurization values after the recovery process. Nevertheless, the recovery procedure will continue normally and you will be able to input the correct feature values in the SAN Volume Controller Admin Console after the cluster is recovered.

Select the set of backup files you wish the cluster to be recovered to. Use the master console to create a new cluster with the same name as the one to be recovered. Once the new cluster has been created, you can proceed with the restore. Perform the following steps:

1. Log on to the cluster and clear the backup directory of any old backup restore files. Issue the following:

```
ssh -l admin your_cluster_name -p 22
```

```
svcconfig clear -all
```

```
exit
```

2. Copy the backup file from your cluster storage by issuing the following:

```
pscp -P 22 /offclusterstorage/svc.config.backup.xml_myconfignode  
admin@your_cluster_name:/tmp/svc.config.backup.xml
```

Log back on to the cluster.

```
ssh -l admin your_cluster_name -p 22
```

3. Issue the following:

```
svcinfolnode
```

Ensure that only one node is online and identify which one it is. If this node was not the configuration node in the configuration you are trying to restore, either make a cluster where it is or select the appropriate backup file.

id	....	status	IO_group_id	IO_group_name	config_node
1	....	online	0	io_grp0	yes

4. Issue the following:

```
svcinfolcluster
```

Ensure that the cluster has been created with the same name as that in the backup files. Output similar to the following is displayed:

Id	name	location
0000020066206BE2	your_cluster_name	local

5. Issue the following:

```
svcconfig restore -prepare
```

This will do a comparison of the current cluster configuration and available resource and the backup file you have put onto the cluster. If there are any errors, the command will fail with a CMMVCnnnnE error. You will need to fix the error and issue the command again.

**Note:** If there has been any change to the fabric since the backup was taken, it will not be possible to restore the chosen configuration.

When this command has completed, you may have received a number of warning messages. You will need to ensure that the action about to be taken is acceptable. You may need to exit the cluster and copy this log file off the cluster for reading, because it may be quite large.

6. In order to read the log file produced by the `-prepare` flag to ensure you are aware of all the warnings that have been issued, exit from the cluster. Issue the following:

```
exit
```

```
pscp -P 22 admin@your_cluster_name:/tmp/svc.config.restore.prepare.log  
/offclusterstorage
```

```
cat /offclusterstorage/svc.config.restore.prepare.log|more
```

to exit the list.

7. When you are satisfied that the restore will happen as expected, log back on to the cluster and execute the restore command. Issue the following:

```
ssh -l admin your_cluster_name -p 22
```

```
svcconfig restore -execute
```

This will use the `svc.config.restore.sh` file to attempt to recover your cluster structure onto the available cluster hardware. Once this has completed, you can check the log file to ensure that no errors or unexpected warnings have been issued about the restore. The output is stored in `svc.config.restore.execute.log`. The following output displays that a successful restore has taken place and that no errors are reported.

```
.....  
IBM_2145:admin>
```

When you have verified the cluster as correct, you may restore your company data from the storage back onto the presented VDisks.

Remove any unwanted configuration backup files from the cluster using the **svcconfig clear** command.

#### Related tasks

“Backing up the cluster configuration” on page 231

To back up a cluster configuration, complete these tasks.

“Create cluster from the front panel” on page 69

After you have created a pair of nodes, you can now create a cluster from the front panel.

“Configuring a cluster using the SAN Volume Controller Console” on page 106

Once you’ve created a pair of nodes, you will then need to create and configure a cluster.

“Configuring the cluster using the CLI” on page 177

You can configure the cluster using the command-line interface (CLI).

#### Related information

Chapter 2, “Preparing to configure the SAN Volume Controller,” on page 69

Once you’ve completed the two phase creation of the cluster, you can begin to configure the SAN Volume Controller.

---

## Deleting a backup configuration file

You can delete a backup cluster configuration by using the Deleting a Cluster Configuration panel or the command-line interface (CLI) **SVCCONFIG** command.

Unneeded backup configuration files and SSH keys can be deleted from the master console or a SAN Volume Controller.

Perform the following steps to delete backup configuration files:

1. Click **Service and Maintenance** from the portfolio.
2. Click **Delete Backup** from the portfolio.
3. Click **OK** to delete the backup configuration file.



---

## Chapter 6. Software upgrade strategy

You can upgrade your software while your day-to-day operations are running.

You must, however, expect performance to be degraded while the software is being installed.

**Note:** Applying a software update takes approximately one hour. This is in part due to the 30 minute delay which is inserted to allow the multi-pathing software to recover.

Software and microcode for the SAN Volume Controller and its attached adapters is tested and released as a single package. The package number is increased each time a new release is made, although only some of the components might have changed. Included in the package are Linux, Apache, and the SAN Volume Controller software.

If you are upgrading through more than one level; for example, from level 1 to level 3, under some circumstances, you might need to install an intermediate level. For example, if you are upgrading from level 1 to level 3, you might need to install level 2 before you install level 3. Details of any prerequisite levels are provided with the source files.

**Attention:** Applying a software upgrade while the node is in service mode results in deleting the node from the cluster. Status information stored within the node will be deleted, and this causes data loss if the cluster is dependent solely on this node.

When upgrading cluster software where the cluster participates in one or more intercluster relationships only one cluster should be upgraded at a time. That is, both clusters should not be upgraded concurrently. The software upgrade should be allowed to complete one cluster before it is started on the other cluster. If both clusters are upgraded concurrently, it may lead to a loss of synchronization. It may further lead to a loss of availability.

**Attention:** Ensure that you have no unfixed errors in the log, and that the Cluster Time/Date is correctly set. Start the Directed Maintenance Procedures and ensure that you fix any outstanding errors before attempting to concurrently upgrade the software.

### Related tasks

“Disruptive software upgrade” on page 242

You can perform a disruptive software upgrade using the command-line interface (CLI).

“Upgrading the SAN Volume Controller firmware using the SAN Volume Controller Console” on page 243

You can upgrade the cluster software using the SAN Volume Controller Console.

“Performing the node rescue” on page 246

You can follow the step-by-step instructions to perform the node rescue.

“Manual recovery from software upgrade problems” on page 251

When a revised version of software is committed, you might not be able to return to a previous software version because some data structures might have been changed such that they cannot be used with the previous software version. Therefore, if you have any problems, you must go forward to a later version of the code.

### Related reference

“Automatic upgrade” on page 247

When new nodes are added to the cluster, the upgrade packages are usually automatically downloaded to them from the SAN Volume Controller cluster. No manual intervention is needed.

“Automatic recovery from upgrade problems” on page 247

The cluster will automatically terminate the upgrade process if any of the nodes fail to upgrade to the new software level.

“PuTTY scp” on page 248

PuTTY scp provides a file transfer mechanism for secure shell (SSH) to copy files either between two directories on the SAN Volume Controller configuration node or between the configuration node and another host.

“Installing the upgrade using the CLI” on page 249

You can install upgraded software using the command-line interface (CLI).

“Installing the software” on page 250

The software is delivered to you as a single package.

---

## Disruptive software upgrade

You can perform a disruptive software upgrade using the command-line interface (CLI).

The IBM Total SAN Volume Controller only supports concurrent code upgrades. To ensure that a code upgrade is coordinated across all nodes in the cluster, it is necessary for the nodes to be able to communicate with each other across the fibre-channel SAN. However, some users may prefer to perform a disruptive code upgrade. The following procedure documents how to quiesce I/O to the SAN before performing a concurrent code upgrade to ensure that there is no I/O in progress during the upgrade.

Perform the following steps to complete the disruptive software upgrade process:

1. Stop any host applications and unmount the file-systems that are using storage that is being managed by the SAN Volume Controller. If your hosts are being shutdown then this will occur as the host is shutdown, otherwise it will be necessary to do this manually on each host. This step will ensure that hosts will stop issuing I/O operations and that any data in the filesystem caches is flushed.
2. Shutdown the cluster by issuing the **svctask stopcluster** command. This command will stop the SAN Volume Controllers from issuing I/O to backend controllers and will flush data from the SAN Volume Controller cache.
3. Rezone the switch so that the SAN Volume Controller nodes are in one zone. Ensure that this zone does not include a host HBA or a backend controller (keep the old switch configuration so it can be restored at step 6). This step isolates the SAN Volume Controller from the rest of the SAN.
4. Power on all the SAN Volume Controller nodes and wait for them to reform a cluster.

**Note:** Because the IBM Total Storage SAN Volume Controller has been isolated from the backend storage you will get some error logs indicating that this has occurred.

5. Perform the software upgrade in the same manner as for a concurrent code upgrade.
6. Restore the original switch configuration.



7. Clear any error logs produced at step 4 on page 242 indicating that backend storage is unavailable. Check that all backend storage is now online and accessible to the SAN Volume Controllers.
8. Remount file-systems and start host applications.

#### **Related tasks**

“Shutting down a cluster or single node using the CLI” on page 228  
You can shut down a cluster using the command-line interface (CLI).

#### **Related reference**

Chapter 6, “Software upgrade strategy,” on page 241  
You can upgrade your software while your day-to-day operations are running.

---

## **Upgrading the SAN Volume Controller firmware using the SAN Volume Controller Console**

You can upgrade the cluster software using the SAN Volume Controller Console.

If you are using Internet Explorer, perform the following:

1. Click on **Tools** in the menu.
2. Select **Internet Options** → **Connections** tab.
3. Click on **LAN Settings...** and ensure that the box marked **Use a proxy server** is unchecked. Click **OK** twice to accept the settings.

If you are using Netscape, perform the following:

1. Click on **Edit** in the menu.
2. Click on **Preferences....** Expand the Advanced section and select **Proxies**.
3. Select the radio button marked **Direct connection to the Internet**. Click **OK** to accept the settings.

**Note:** You cannot download the upgrade. You need to download the file to your local directory so the package can be uploaded in the process.

Software upgrade files can be quite large, if you experience problems when uploading upgrade files to the cluster reliably, you should disable proxies on the Web browser from where you will upload the file. This should also shorten the file upload time.

**Note:** If you disable proxies, you may not be able to connect to external Web sites. It is therefore advised that prior to disabling proxies, you make a record of your existing settings in case you need to restore access to other Web sites.

Perform the following steps to upgrade the software:

1. Click **Service and Maintenance** from the portfolio.
2. Click **Upgrade Software** to check the installed software level or to install a new level of software on the cluster. The Software Upgrade panel is displayed.



Figure 45. Software upgrade panel

3. Click **Upload** to copy a new software level from your host to the cluster. (This action uses the upload feature of the Web browser.) The Software upgrade - file upload panel is displayed.

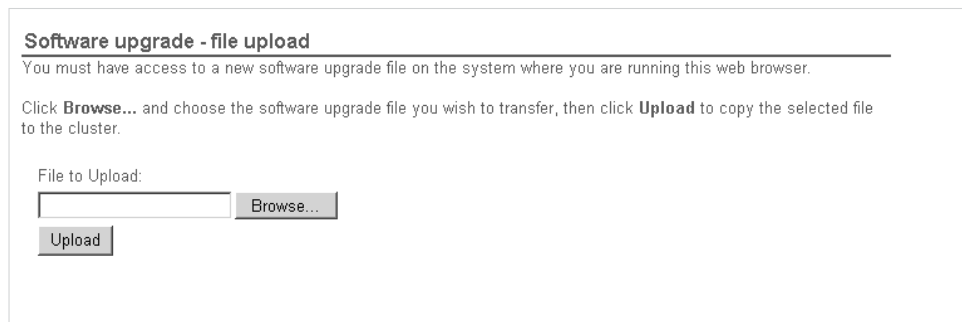

Figure 46. Software upgrade - file upload panel

You can get new software levels from the IBM Product Support Web site, or from an installation CD.

After a successful copy of the file, the install process fails if all the nodes configured into the cluster are not present. This behavior cannot be overridden using the force flag. If any node configured to be a member of the cluster is not present then in order to upgrade the software the node must either be deleted from the cluster or must be brought online. Furthermore, if a node has been deleted from the cluster such that any IO group has only one member then the software upgrade will also fail. This is because the upgrade process will result in loss of access to data. The force flag can be used to override this restriction if you are prepared to loose access to data during the upgrade.

Before you begin the software upgrade, make sure that you are aware of the following:

- The code is distributed to all the nodes in the cluster using fibre channel connections between the nodes.
- Nodes are updated one at a time.
- Nodes will begin executing the new software, concurrently with normal cluster activity.
- The procedure to update a single node takes approximately 5 minutes.
- During the update of a node it does not participate in I/O activity in the I/O group. Thus all I/O activity for the virtual disks in the I/O group is directed to the other node in the I/O group by the host multi-pathing software. During the update of a node the other node in the I/O group will notice that it's partner is

not participating in the cluster and will as a result attempt to flush the writeback cache and set it into write-through mode. This flush is not guaranteed to be successful or to complete and as a result concurrent software update does create a single point of data loss. Should the remaining node in an I/O group experience a failure during a software update of its partner then the only valid copy of dirty data in the writeback cache could be lost.

- All of the nodes connected to one uninterruptible power supply are updated first before any of the nodes connected to the other uninterruptible power supply.
  - A 30 minute delay is inserted into the procedure between updating the nodes connected to one uninterruptible power supply and starting to update the nodes on the other uninterruptible power supply. This allows time for the host mult-ipathing software to rediscover paths to the nodes on the first uninterruptible power supply so that when nodes on the second uninterruptible power supply are updated loss of access does not result.
  - The update is not committed until all nodes in the cluster have been successfully updated to the new code level. If all nodes successfully restart with the new code the new version is committed. When this happens, the cluster VPD is updated to reflect the new level of code. After this point downgrade to a package with a lower major number is no longer possible.
  - New behaviors or functions in the installed software will only be available to be invoked when all member nodes are upgraded and the update is committed.
  - Since the software upgrade process takes some time the install command completes as soon as the software package is verified by the cluster. To determine when the upgrade has completed you must either display the software version in the cluster VPD or look for the Software upgrade complete event in the error/event log. If any node fails to restart with the new code level or fails at any other time during the process the code is backed-off.
  - During a software upgrade the version number of each node is updated when the software has been installed and that node has been restarted. The cluster software version number is updated when the new version of software is committed.
  - When code upgrade starts an entry is made in the error or event log and another entry is made when the upgrade completes or fails.
4. Click **Apply upgrade** to display the Applying Software Upgrade panel. This page enables you to select the upgrade and to apply it to the cluster. This page displays a list of the software levels that you can apply to the cluster.

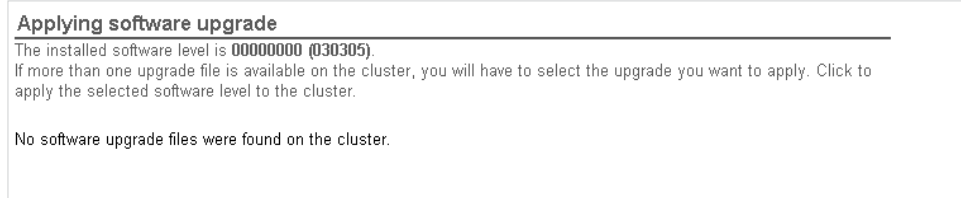

Figure 47. Applying software upgrade panel

When a new code level is applied, it is automatically installed on all the nodes that are in the cluster. Note this process can take up to 30 minutes per node.

#### Related reference

---

## Performing the node rescue

You can follow the step-by-step instructions to perform the node rescue.

If it is necessary to replace the hard disk drive or if the software on the hard disk drive has become corrupted, you can reinstall the software on the SAN Volume Controller by using the node rescue procedure.

To provide an alternate boot device, a minimal operating system is also available in nonvolatile memory on the service controller. If it is necessary to replace the hard disk drive or the software on the hard disk drive has become corrupted, the SAN Volume Controller cannot boot and the Hardware Boot indicator remains on the front panel display or the boot operation hangs.

If this occurs, you can reinstall the software on the SAN Volume Controller by using the node rescue procedure. Node rescue works by booting the operating system from the service controller and running a program that will copy all the node software from any other SAN Volume Controller that can be found on the fibre-channel fabric. The following procedure tells you how to run the node rescue procedure.

Perform the following steps to complete the node rescue:

1. Ensure that the fibre-channel cables are connected.
2. Ensure that at least one other SAN Volume Controller node is connected to the fibre-channel fabric.
3. Turn off the SAN Volume Controller.
4. Press and hold the left and right buttons on the front panel.
5. Press the power button.
6. Continue to hold the left and right buttons until the Node Rescue Request symbol is displayed on the front panel.



*Figure 48. Node-rescue-request display*

The node rescue request symbol displays on the front panel display until the SAN Volume Controller starts to boot from the service controller. If the node rescue request symbol displays for more than two minutes, check the connection between the service controller and the system board. The service display shows the progress or failure of the node rescue operation.

**Note:** If the recovered node was part of a cluster, the node will now be offline. Delete the offline node from the cluster and then add the node back into the cluster. If node recovery was used to recover a node that failed during a software upgrade process, the automatic software downgrade process will start but may not continue until the failed node is deleted from the cluster.

After the failed node is deleted, it is not possible to add the node back into the cluster until the downgrade process has completed. This may take up to two hours.

If the cables are correctly located and the node rescue request symbol still displays, replace the FRUs in the following sequence:

1. System board assembly
2. Service controller

**Related reference**

Chapter 6, “Software upgrade strategy,” on page 241

You can upgrade your software while your day-to-day operations are running.

---

## Automatic upgrade

When new nodes are added to the cluster, the upgrade packages are usually automatically downloaded to them from the SAN Volume Controller cluster. No manual intervention is needed.

New nodes introduced to the cluster normally have software packages downloaded to them from the cluster without any manual intervention. A new node requiring a code version higher than that currently available on the cluster or a node that already contains a code version higher than that on the cluster will not be configured into the cluster. If a node is added to the network that has no code installed, for example because the disk drive has been replaced, or it has such an old code version installed that it cannot advertise itself to the clusters, a reinstall of the software is forced by using the Node Rescue procedure.

If you add a new SAN Volume Controller node that has a code version that is higher than the one that is available on the cluster, that node is *not* configured into the cluster. It will join the cluster, however the node will be downgraded to the cluster level.

**Error counts:** During the SAN Volume Controller software upgrade, you can expect to see either I/O error counts displayed by the data-path query adapter, or an increase in the number of **datapath query device** commands if active I/O operations exist between hosts and the SANs. See the *IBM TotalStorage Subsystem Device Driver: User's Guide* for more information about **datapath query** commands.

During the software upgrade, each SAN Volume Controller node of a working pair is upgraded sequentially. The SAN Volume Controller node that is being upgraded is temporarily unavailable, and all I/O operations to that SAN Volume Controller fail. As a result, I/O error counts increase. However, failed I/O operations are directed to the other SAN Volume Controller node of the working pair, and applications should not see any I/O failures.

**Related reference**

Chapter 6, “Software upgrade strategy,” on page 241

You can upgrade your software while your day-to-day operations are running.

---

## Automatic recovery from upgrade problems

The cluster will automatically terminate the upgrade process if any of the nodes fail to upgrade to the new software level.

In this case, any nodes that have already upgraded to the new software level will downgrade back to the original code level. You should check the error log to determine the reason for the failure before attempting to upgrade the cluster again.

#### Related reference

Chapter 6, “Software upgrade strategy,” on page 241

You can upgrade your software while your day-to-day operations are running.

---

## PuTTY scp

PuTTY scp provides a file transfer mechanism for secure shell (SSH) to copy files either between two directories on the SAN Volume Controller configuration node or between the configuration node and another host.

### Overview

You must have appropriate permissions on the source and destination directories on your respective hosts to be able to use pscp. PuTTY scp is available to you when you install an SSH client on your host system. The pscp application can be accessed through a command line.

To start pscp, ensure that it is on your PATH or in your current directory. To add the directory containing pscp to your PATH environment variable, issue the following:

```
set PATH=C:\path\to\putty\directory;%PATH%
```

Open your console window and issue the following: pscp. This will bring up a usage message. The message provides the version of pscp you're using and gives you a brief summary of how to use pscp.

If you want to use pscp, perform the following:

1. Start a PuTTY session in order to access your SAN Volume Controller Console cluster.
2. Save your configuration. For example, your saved session is called SVCPUTTY.
3. From a Command Prompt window, set up your path by issuing the following commands:

```
set PATH=C:\path\to\putty\directory;%PATH%
set PATH=C:\Program Files\Putty;%PATH%
```

4. Copy the package onto the node where the CLI is running from the Master console. Ensure you are in the software directory called C:\SVC\_Software\_Directory.

```
pscp -load SVCPUTTY svc_code_name admin@
<cluster_ip_address>:/home/admin/upgrade
```

where *<cluster\_ip\_address>* is your cluster IP address. You are notified of copy failures by error messages from the CLI and the SAN Volume Controller Console. If there is insufficient space on the cluster to store the software upgrade package then the copy operation will fail. If this occurs, issue the **svctask cleardumps** command to make space for the upgrade package, then repeat the copy operation.

Alternatively, you can transfer error logs to the master console using pscp. To scp the error logs from the cluster to the master console, issue the following:

```
pscp -unsafe -load SVCPUTTY admin@<cluster_ip_address>:  
/dumps/elog/* c:/svc_directory
```

where <cluster\_ip\_address> is your cluster IP address.

### Related reference

Chapter 6, “Software upgrade strategy,” on page 241

You can upgrade your software while your day-to-day operations are running.

---

## Installing the upgrade using the CLI

You can install upgraded software using the command-line interface (CLI).

You can use either PuTTY scp (pscp) or the SAN Volume Controller Console to copy the upgrade package to each SAN Volume Controller cluster or issue CLI commands.

If you want to use pscp, perform the following:

1. Start a PuTTY session in order to access your SAN Volume Controller Console cluster.
2. Save your configuration. For example, your saved session is called SVCPUTTY.
3. From a Command Prompt window, set up your path by issuing the following commands:

```
set PATH=C:\path\to\putty\directory;%PATH%  
set PATH=C:\Program Files\Putty;%PATH%
```

4. Copy the package onto the node where the CLI is running from the Master console. Ensure you are in the software directory called C:\SVC\_Software\_Directory.

```
pscp -load SVCPUTTY svc_code_name admin@  
<cluster_ip_address>:/home/admin/upgrade
```

where <cluster\_ip\_address> is your cluster IP address. You are notified of copy failures by error messages from the CLI and the SAN Volume Controller Console. If there is insufficient space on the cluster to store the software upgrade package then the copy operation will fail. If this occurs, issue the **svctask clear.dumps** command to make space for the upgrade package, then repeat the copy operation.

Alternatively, you can transfer error logs to the master console using pscp. To scp the error logs from the cluster to the master console, issue the following:

```
pscp -unsafe -load SVCPUTTY admin@<cluster_ip_address>:  
/dumps/elog/* c:/svc_directory
```

where <cluster\_ip\_address> is your cluster IP address.

5. After a successful copy of the file, issue the **svcservicetask applysoftware -file filename** command, where *filename* is the name of the file that you copied the software upgrade package too. This command starts the installation of the code. The installation process will fail if a node is not present and if the node is not paired with another node in an I/O group. You can, however, use the **-force** option to override this restriction if you are prepared to lose access to data during the upgrade.

**Note:** The installation process will *only* fail when some paths between the host systems and the cluster are not available. Data access can be lost

temporarily during the upgrading process. You can prevent this if, before you start the installation, you issue a data-path query device on each host system to ensure that all paths are available. See the *IBM TotalStorage Subsystem Device Driver: User's Guide* for more information about data-path query commands.

**Attention:** The order in which the nodes are upgraded depends on the following:

- The position of the nodes. The code will be transferred to all the nodes in an I/O group.
  - The I/O group ID. The code will be transferred from the lowest I/O group ID that includes nodes on it.
6. To verify that the upgrade was successful, you can perform any one of the following steps:
- The code level is distributed to all the nodes that are in the cluster. The nodes, in turn, are then restarted. If all the nodes successfully restart with the new code level, the new version is committed and the cluster vital product data (VPD) is updated to new level of code.
  - The software upgrade is complete when the cluster verifies the upgrade package. To determine whether the upgrade has completed, you must either display the software version in the cluster VPD, or look for the Software upgrade complete event in the SAN Volume Controller error or event log. If the node does not restart automatically during the upgrade, you should repair or manually delete that node from the cluster to complete the backout process.
  - Alternatively, you can also either perform the following steps:
    - a. Issue the **svctask dumperrlog** command to dump the contents of the error log to a text file. You can also use this command to delete unwanted error log dumps from the cluster.
    - b. Once you have the contents of the error log dumped into a text file, verify that there were no errors in the text file. If there are no errors, you have successfully upgraded the software and output similar to the following is displayed in the log file:

```
Upgrade completed successfully
```
    - c. Issue the **svcinfo lsnodevpd** command for each node. You should see that the software version field has been updated.

#### Related reference

Chapter 6, “Software upgrade strategy,” on page 241

You can upgrade your software while your day-to-day operations are running.

“SAN Volume Controller library and related publications” on page xvi

A list of other publications that are related to this product are provided to you for your reference.

---

## Installing the software

The software is delivered to you as a single package.

### Software package

Cluster software versions comprise a number of software components that are delivered as a single package. Cluster software versions comprise a number of



software components that are delivered as a single package. The size of the software update package depends on the number of components that are being replaced by that upgrade package. The software installation procedure involves copying the new software version to the cluster and then starting an automatic installation process. This installation process might take up to an hour to complete and during the process each of the nodes is restarted in turn. Once all the nodes in the cluster have been successfully restarted with the new software the new software version is automatically committed. While each node is being restarted there might be some degradation in the maximum input/output rate that can be sustained by the cluster.

### Installation operation

The installation operation can normally be performed concurrently with normal user I/O operations. If any restrictions apply to the operations that can be performed during the upgrade, then these restrictions will be documented on the SAN Volume Controller web site from where the upgrade package was obtained. During the upgrade operation, only the following SAN Volume Controller commands will be operational from the time the install process starts to the time that the new software is committed or until the process has been backed-out. All other commands will fail with a message indicating that a software upgrade is in progress. In the following commands, xxxx is the object type.

- **svcinfo lsxxxx**
- **svcinfo lsxxxxcandidate**
- **svcinfo lsxxxxprogress**
- **svcinfo lsxxxxmember**
- **svcinfo lsxxxxextent**
- **svcinfo lsxxxxdumps**
- **svcinfo caterrlog**
- **svcinfo lserrlogbyxxxx**
- **svcinfo caterrlogbyseqnum**
- **svctask rmnode**
- **svcservicetask rmnode**

Because of the operational limitations that occur during the upgrade process the software installation is a customer task.

#### Related reference

Chapter 6, "Software upgrade strategy," on page 241

You can upgrade your software while your day-to-day operations are running.

---

## Manual recovery from software upgrade problems

When a revised version of software is committed, you might not be able to return to a previous software version because some data structures might have been changed such that they cannot be used with the previous software version. Therefore, if you have any problems, you must go forward to a later version of the code.

**Attention:** This procedure causes a loss of *all* data currently configured in the cluster. This is a last resort and should only be done if you have recently backed-up your data.

In extreme conditions where you cannot wait for a software update and you need to return to the previous software version, you can use the following procedure.

**Attention:** This procedure, however, causes the total loss of the SAN Volume Controller cluster. This should only be done as a last resort.

Perform the following steps to reset from software upgrade problems:

1. Power-off all but one of the nodes that are in the cluster.
2. Set the powered-on node to the service access mode.
3. Use the service access functions to force the download of the older software package.
4. Repeat the action for each of the failed nodes.
5. From a node that has the new code, create a new cluster.

**Related reference**

Chapter 6, “Software upgrade strategy,” on page 241

You can upgrade your software while your day-to-day operations are running.

**Related information**

“Resetting a refused SSH key” on page 163

You can reset a refused SSH key relationship between the SAN Volume Controller Console and the SAN Volume Controller cluster.

---

## Chapter 7. Configuring other SAN devices and SAN switches for use with the SAN Volume Controller

Ensure that you are familiar with configuring disk controllers and switches for use with the SAN Volume Controller.

### Related reference

“Configuring and servicing storage subsystems”

Follow the guidelines and procedures outlined in this section to make the most of the performance available from your storage subsystems and to avoid potential I/O problems.

“Configuring the EMC CLARiiON subsystem” on page 273

This part provides information about configuring the EMC CLARiiON storage system for its attachment to a SAN Volume Controller.

“Configuring the EMC Symmetrix subsystem” on page 285

This part provides information about configuring the EMC Symmetrix, for attachment to a SAN Volume Controller.

“Configuring the HP StorageWorks subsystem” on page 328

This part provides information about configuring the HP StorageWorks subsystem, which uses the HSG80 controller, so it can attach to a SAN Volume Controller.

### Related information

“Configuring the Enterprise Storage Server” on page 293

This part provides information about configuring the Enterprise Storage Server (ESS) so it can attach to a SAN Volume Controller.

“Configuring the FAStT subsystem” on page 298

This part provides information about configuring the FAStT subsystem so it can attach to a SAN Volume Controller.

“Configuring the HDS Lightning subsystem” on page 309

This part provides information about configuring the HDS Lightning subsystem so it can attach to a SAN Volume Controller.

“Configuring the HDS Thunder subsystem” on page 317

This part provides information about configuring the HDS Thunder subsystem so it can attach to a SAN Volume Controller.

“Configuring the HPQ Enterprise Virtual Array (EVA) subsystem” on page 346

This part provides information about configuring the HPQ Enterprise Virtual Array (EVA) disk controller system so it can attach to a SAN Volume Controller.

---

## Configuring and servicing storage subsystems

Follow the guidelines and procedures outlined in this section to make the most of the performance available from your storage subsystems and to avoid potential I/O problems.

### Overview

Although virtualization provides many benefits over direct attached or direct SAN attached storage, it is also more liable to and is not restricted by the creation of performance hot-spots. These hot-spots could lead to I/O errors being returned to your hosts, and potentially a loss of access to data may occur.

### Related reference

#### “Configuration guidelines”

Follow the guidelines and procedures outlined in this section to make the most of the performance available from your storage subsystems and to avoid potential I/O problems.

#### Related information

##### “Identifying your storage subsystem”

The serial number presented by the command-line and Web application on the SAN Volume Controller is the serial number of the device.

## Identifying your storage subsystem

The serial number presented by the command-line and Web application on the SAN Volume Controller is the serial number of the device.

The serial numbers can be viewed on your storage subsystem. If the serial numbers are not displayed, the WWNN or WWPN will be displayed. The WWNN or WWPN can be used to identify the different subsystems.

## Configuration guidelines

Follow the guidelines and procedures outlined in this section to make the most of the performance available from your storage subsystems and to avoid potential I/O problems.

### Guidelines

- Avoid splitting arrays into multiple logical disks at the storage subsystem layer. Where possible, create a single logical disk from the entire capacity of the array.
- Depending upon the redundancy required, RAID-5 arrays should be created using between 5 and 8 plus parity components. That is 5 + P, 6 + P, 7 + P or 8 + P.
- Ensure that managed disk groups contain managed disks with similar characteristics and approximately the same capacity. Consider the following factors:
  - the underlying RAID type that the storage subsystem is using to implement the managed disk
  - the number of physical disks in the RAID array and the physical disk type (for example, 10K/15K rpm, FC/SATA).
- Do not mix managed disks of greatly differing performance in the same managed disk group. The overall group performance will be limited by the slowest managed disk in the group. Some disk controllers may be able to sustain much higher I/O bandwidths than others, ensure you do not mix managed disks provided by low-end subsystems with those provided by high-end subsystems.
- Avoid leaving virtual disks in image mode. Only use image mode to import existing data into the cluster. This data should be migrated across the other managed disks in the group as soon as possible to optimize the benefits of virtualization.
- Follow the FlashCopy requirements before setting up the storage. Balance the spread of the FlashCopy virtual disks across the managed disk groups and then the storage subsystems. The I/O characteristics of the application writing to the source virtual disk also effects the impact that FlashCopy operations have on your overall I/O throughput.
- Perform the appropriate calculations to ensure your storage subsystems are configured correctly.

### Related reference

#### “Storage subsystem logical disks”

Most storage subsystems provide some mechanism to create multiple logical disks from a single array. This is useful when the storage subsystem is directly presenting storage to the hosts.

#### “RAID array configuration”

When using virtualization, ensure that the storage devices are configured to provide some type of redundancy against hard disk failures.

#### “Optimal managed disk group configurations” on page 256

A managed disk group provides the pool of storage from which virtual disks will be created. It is therefore necessary to ensure that the entire pool of storage provides the same performance and reliability characteristics.

#### “Considerations for FlashCopy mappings” on page 257

Ensure that you’ve considered the type of I/O and frequency of update before creating the virtual disks that you wish to use in FlashCopy mappings.

#### “Image mode and migrating existing data” on page 257

Image mode virtual disks are provided primarily to enable the importing and subsequent migration of existing data under the SAN Volume Controller.

### **Storage subsystem logical disks**

Most storage subsystems provide some mechanism to create multiple logical disks from a single array. This is useful when the storage subsystem is directly presenting storage to the hosts.

In a virtualized SAN, however, where possible, there should be a one-to-one mapping between arrays and logical disks. Ensuring that the arrays are configured in this way will make the subsequent load calculations and the managed disk and managed disk group configuration tasks a lot easier.

For example, you have two RAID-5 arrays and both contain 5 + P components. Array A has a single logical disk that is being presented to the SAN Volume Controller cluster. This is seen by the cluster as mdisk0. Array B has three logical disks that are being presented to the SAN Volume Controller cluster. These are seen by the cluster as managed disks 1 through 3. All four managed disks are assigned to the same managed disk group, mdisk\_grp0. When a virtual disk is created by striping across this group, what actually takes place is that array A presents the first extent and array B presents the next 3 extents. Therefore, when reading and writing to the virtual disk, the loading is split 25% on the disks in array A and 75% on the disks in array B. The performance of the virtual disk will in general be one third of what array B can sustain.

This example describes the performance degradation and complexity that is introduced by having uneven logical disks in a simple configuration. As stated in the guideline summary, you should aim to create a single logical disk from each array.

### **RAID array configuration**

When using virtualization, ensure that the storage devices are configured to provide some type of redundancy against hard disk failures.

#### **Overview**

A failure of a storage device can affect a larger amount of storage being presented to the hosts. To provide redundancy, storage devices should be configured as RAID arrays which use either mirroring or parity to protect against single failures.

When creating RAID arrays with parity protection (for example, RAID-5 arrays) consider how many component disks you want to use in each array. The larger the number of disks, the fewer disks are required to provide availability for the same total capacity (1 per array). However, more disks means a longer time is taken to rebuild a replacement disk after a disk failure, and during this period a second disk failure will cause a loss of all array data. More data is affected by a disk failure for a larger number of member disks resulting in reduced performance while rebuilding onto a hot spare and more data being exposed if a second disk fails before the rebuild has completed. The smaller the number of disks, the more likely it is that write operations span an entire stripe (strip size x number of members minus one). In this case, write performance is improved. The number of disk drives required to provide availability may be unacceptable if arrays are too small.

**Note:**

1. If in doubt, arrays with between 6 and 8 member disks is recommended.
2. When creating RAID arrays with mirroring, the number of component disks in each array does not affect redundancy or performance.

**Optimal managed disk group configurations**

A managed disk group provides the pool of storage from which virtual disks will be created. It is therefore necessary to ensure that the entire pool of storage provides the same performance and reliability characteristics.

- The performance of a managed disk group will generally be governed by the slowest managed disk in the group.
- The reliability of a managed disk group will generally be governed by the weakest managed disk in the group.
- If a single managed disk in a group fails, access to the entire group will be lost.

These guidelines show that grouping similar disks together is important. The following guidelines should be followed when grouping similar disks:

- Group equally performing managed disks, arrays, in a single group.
- Group similar arrays, for example, all 6 + P RAID-5 arrays, in one group.
- Group managed disks from the same type of storage subsystem in a single group.
- Group managed disks that use the same type of underlying physical disk (for example, fibre-channel, SATA).
- Do not use single disks. Single disks provide no redundancy. Failure of a single disk will result in total data loss of the managed disk group to which it is assigned.

For example, you have two storage subsystems attached behind your SAN Volume Controller. One device is an IBM ESS, which contains ten 6 + P RAID-5 arrays, mdisks 0 through 9. The other device is an IBM FASTT200, which contains a single RAID-1 array, mdisk10, one single JBOD, mdisk11, and a large 15 + P RAID-5 array, mdisk12. If you assigned mdisks 0 through 9 and mdisk11 into a single managed disk group, and the JBOD, mdisk11, fails, you would lose access to all of the ESS arrays, even though they are online. The performance would likely be limited to that available to the JBOD in the FASTT storage subsystem, thus slowing down the ESS arrays.

The ideal configuration with the above components would be to create three groups. One which contained the ESS arrays, MDdisks 0 through 9, another which contained the RAID-1 array, and the third group containing the large RAID-5 array.

### **Related tasks**

“Configuring a balanced storage subsystem” on page 260

The attachment of a storage subsystem to a SAN Volume Controller requires that some specific settings be applied to the device, some limitations are also listed for each storage type.

### **Considerations for FlashCopy mappings**

Ensure that you've considered the type of I/O and frequency of update before creating the virtual disks that you wish to use in FlashCopy mappings.

FlashCopy will perform in direct proportion to the performance of the source and target disks. That is, if you have a fast source disk and slow target disk, the performance of the source disk will be reduced as it has to wait for the write to happen at the target before it can write to the source.

The FlashCopy implementation provided by the SAN Volume Controller copies at least 256K every time a write is made to the source. This means that *any* write will at a minimum involve a read of 256K from the source, write of the same 256K at the target, and then a write of the original change at the target. Therefore, when an application is performing small 4K writes, this is translated into 256K.

Due to this overhead, consider the type of I/O your application will be performing during a FlashCopy. Ensure that you will not be overloading the storage. The calculations contain a heavy weighting when FlashCopy is active. The weighting itself depends on the type of I/O being performed. Random writes have a much higher overhead than sequential writes, for example, as the sequential write would have copied the entire 256K anyway.

You may spread the FlashCopy source virtual disks and the FlashCopy destination virtual disks between as many managed disk groups as possible. This will limit the potential bottle-necking of a single storage subsystem, (assuming that the managed disk groups contain managed disks from different storage subsystems). However, this may still result in potential bottle-necking if you wish to maintain all your target virtual disks on a single storage subsystem. Ensure that you add the appropriate weighting to your calculations.

### **Related tasks**

“Configuring a balanced storage subsystem” on page 260

The attachment of a storage subsystem to a SAN Volume Controller requires that some specific settings be applied to the device, some limitations are also listed for each storage type.

### **Image mode and migrating existing data**

Image mode virtual disks are provided primarily to enable the importing and subsequent migration of existing data under the SAN Volume Controller.

Ensure that you following the guidelines when using image mode virtual disks. This may be difficult as a configuration of logical disks and arrays that performed well in a direct SAN attached environment may contain hot-spots or hot-component disks when connected via the SAN Volume Controller cluster.

If the existing storage subsystems are configured incorrectly, with respect to the guidelines, you may wish to consider stopping I/O at your hosts while migrating the data into the cluster. If I/O is continued and the storage subsystem does not follow the guidelines, I/O may fail at your hosts and ultimately loss of access to the data will occur.

How you proceed when importing many managed disks that contain existing data, depends on how much free capacity you have in the SAN Volume Controller cluster.

- You should have the same amount of free space in the cluster as the data you wish to migrate into the cluster.
- If you do not have this amount of capacity available, you can still migrate the data into the cluster, however, this is not recommended. The resulting managed disk group will have an uneven distribution of data, with some managed disks being much more heavily loaded than others. Further migration operations will be required to ensure an even distribution of data and therefore, subsequent I/O loading.

#### **Related tasks**

“Configuring a balanced storage subsystem” on page 260

The attachment of a storage subsystem to a SAN Volume Controller requires that some specific settings be applied to the device, some limitations are also listed for each storage type.

#### ***Migrating data with an equivalent amount of free capacity:***

To ensure that your free capacity is equivalent to the capacity of the data being imported, complete these tasks.

1. Stop all I/O operations from your hosts. Un-map the logical disks that contain the data from your hosts.
2. Create one or more managed disk groups with free capacity, that is, space where you wish to migrate the data to. Ensure that these groups have enough free capacity to migrate all the existing data and that they are configured in a well balanced manner.
3. Create an empty managed disk group. This will temporarily contain the data being imported.
4. Create an image mode virtual disk from the first managed disk that contains the data to be imported. To do this, perform the following steps:
  - a. Map one logical disk from the storage subsystem to the SAN Volume Controller ports.
  - b. Issue the **svctask detectmdisk** command on the cluster. The new managed disk that is found will correspond with the logical disk mapped in the previous step.
  - c. Create an image mode virtual disk from this managed disk. Assign it to use the empty managed disk group just created.
  - d. Repeat for all logical disks as required.
5. If you have decided to continue the I/O operations while you migrate the data into SAN Volume Controller, map all the image mode virtual disks to the hosts using the SAN Volume Controller and continue accessing the data through the SAN Volume Controller.
6. Migrate the data into the managed disk groups you created in step 2. To do this, perform the following:
  - a. Select the first image mode virtual disk to be migrated.
  - b. Migrate this virtual disk from its current managed disk group into one of the managed disk groups created in step 2 above. This will migrate all the data from the logical disk into the new free space.
  - c. When this completes, select the next image mode virtual disk and repeat the previous step.



7. When all the virtual disks have been migrated you will end up with the managed disk groups created in step 2 on page 258 containing the data that was on the image mode virtual disks. This data will be striped across the new groups and will be virtualized.
8. You should now go back and destroy the temporary managed disk group that contained the original image mode virtual disks.
9. Go back to the storage subsystem and re-configure the old arrays and logical disks according to the guidelines.
10. Add this storage back under the SAN Volume Controller and use the old storage to create new virtual disks.

**Related reference**

“Configuration guidelines” on page 254

Follow the guidelines and procedures outlined in this section to make the most of the performance available from your storage subsystems and to avoid potential I/O problems.

***Migrating data with a smaller amount of free capacity:***

To migrate existing data with a small amount of free capacity, complete these tasks.

A small amount of free capacity is available. The RAID arrays containing the existing data will still contain the data after importing the arrays to the cluster.

**Attention:** This will result in an uneven distribution of data across the managed disks in the managed disk group. The severity of which will depend on how many managed disks there are in the managed disk group, initially, and how many of these have free capacity. For example, you have one managed disk in the destination managed disk group. You bring in image mode LUNs from an array on the storage subsystem. You migrate these LUNs to the destination managed disk group. These LUNs are now striped across the one managed disk. Now you add another LUN to the destination managed disk group. So, it has two managed disks in it now, but all of the data is on the first managed disk. No managed disks are in the second group and once again have very unbalanced storage. There will always a lot more data on the first few managed disks in this managed disk group than in the last managed disks that were added, and once again have very poorly balanced storage with 1 or 2 managed disks being extremely loaded. Some subset of data will have to be migrated from the overloaded managed disks to the under utilized ones.

**Attention:** This procedure may require subsequent migration of data within the managed disk group in order to even out the distribution of data across the managed disks in the group.

1. Select a managed disk group which contains enough free capacity to migrate *all* of the logical disks on the first array to be migrated into the cluster.
2. Create an empty managed disk group this will temporarily contain the data being imported.
3. Stop all I/O operations to the logical disks that are to be migrated first and un-map these disks from their hosts.
4. Create an image mode virtual disk from the first managed disk that contains the data to be imported. To do this, perform the following steps:
  - a. Map one logical disk from the storage subsystem to the SAN Volume Controller ports.

- b. Issue the **svctask detectmdisk** command on the cluster. The new managed disk that is found will correspond with the logical disk mapped in the previous step.
  - c. Create an image mode virtual disk from this managed disk. Assign it to use the empty managed disk group just created.
  - d. Repeat for all logical disks as required.
5. If you have decided to continue the I/O operations while you migrate the data into SAN Volume Controller, map all the image mode virtual disks to the hosts using the SAN Volume Controller and continue accessing the data through the SAN Volume Controller.
6. Migrate the data into the managed disk groups you created in step 1 on page 259. To do this, perform the following:
  - a. Select the first image mode virtual disk to be migrated.
  - b. Migrate this virtual disk from its current managed disk group into one of the managed disk groups created in step 1 on page 259 above. This will migrate all the data from the logical disk into the new free space.
  - c. When this completes, select the next image mode virtual disk and repeat the previous step.
7. The RAID array that contains the logical disks can now be re-configured and added to the managed disk group selected in step 1 on page 259. To do this, perform the following steps:
  - a. Remove the managed disks from the temporary managed disk group.
  - b. At the storage subsystem, the logical disks that have been migrated should be unmapped from the SAN Volume Controller cluster and deleted from the array (if more than one existed).
  - c. Assuming the array meets the guidelines, a single logical disk should be created using the entire array capacity.
  - d. This new logical disk can be mapped to the SAN Volume Controller ports.
  - e. Issue the **svctask detectmdisk** command on the cluster. The new managed disk that is found will correspond with the new logical disk created.
  - f. Add this managed disk to the managed disk group selected in step 1 on page 259.
8. Repeat steps 3 on page 259 through 7 for the next array.

**Related reference**

“Configuration guidelines” on page 254

Follow the guidelines and procedures outlined in this section to make the most of the performance available from your storage subsystems and to avoid potential I/O problems.

## Configuring a balanced storage subsystem

The attachment of a storage subsystem to a SAN Volume Controller requires that some specific settings be applied to the device, some limitations are also listed for each storage type.

There are 2 major steps in this process:

1. Setting the characteristics of the SAN Volume Controller to storage connection(s)
2. Mapping logical unit(s) to these connections such that the SAN Volume Controller can access them.

The virtualization features of the IBM Total Storage SAN Volume Controller enable you to choose how your storage is divided up and presented to hosts. While virtualization provides you with a great deal of flexibility, it also offers the potential for setting up a storage subsystem which can be overloaded. A storage subsystem is overloaded if the quantity of I/O transactions that are being issued by the host systems exceeds the capability of the storage to process those transactions. If a storage subsystem is overloaded, then, at best, it causes delays in the host systems and, at worst, it causes I/O transactions to be timed out in the host which leads to errors being logged by the hosts and I/Os being failed back to applications.

As an extreme example of an overloaded storage subsystem it would be possible to use an IBM Total Storage SAN Volume Controller to virtualize a single RAID array and to divide this storage among 64 host systems. Clearly, if all host systems attempt to access this storage at the same time the single RAID array will be overloaded. The following guidelines are provided to help you configure balanced storage subsystems.

1. Calculate the I/O rate for an array. For each RAID array in the storage subsystem use the following table to calculate the approximate number of I/O operations per second that can be processed by the RAID array. Note that the actual number of I/O operations per second that can be processed will vary depending on the location and length of each I/O, whether the I/O is a read or a write operation and on the specifications of the component disks of the RAID array. For example, a RAID-5 array with eight component disks has an approximate I/O rate of  $150 * 7 = 1050$ .

Table 17. Calculate the I/O rate

Type of RAID Array	Number of component disks in the RAID Array	Approximate I/O rate
RAID-1 (mirrored) arrays	2	300
RAID-3, RAID-4, RAID-5 (striped + parity) arrays	$N + 1$ parity	$150 * N$
RAID-10, RAID 0+1, RAID 1+0 (striped + mirrored) arrays	$N$	$150 * N$

2. Calculate the I/O rate for a managed disk. If there is a one-to-one relationship between backend arrays and managed disks (this is the recommended configuration) then the I/O rate for a managed disk is the same as the I/O rate of the corresponding array. If an array is divided up into multiple managed disks then the I/O rate per managed disk is the I/O rate of the array divided by the number of managed disks that are using that array.
3. Calculate the I/O rate for a managed disk group. The I/O rate for a managed disk group is simply the sum of the I/O rates of the managed disk within that group.  
For example, a managed disk group contains eight managed disks each of which corresponds to a RAID-1 array. From the table above the I/O rate for each managed disks can be calculated as 300. The I/O rate for the managed disk group is therefore  $300 * 8 = 2400$ .
4. Calculate the impact of FlashCopy relationships. If you are using the FlashCopy feature provided by the IBM Total Storage SAN Volume Controller then you need to consider how much additional I/O will be generated by using this feature as this will reduce the rate at which I/O from host systems that can be processed. When a FlashCopy relationship is copying data any write I/Os from host systems to areas of the source or target virtual disk that have not yet been

copied will cause extra I/Os to be generated by the IBM Total Storage SAN Volume Controller to copy the data before the write I/O is actually performed. The effect of using FlashCopy depends on the type of I/O workload being generated by an application:

Table 18. Calculate the impact of FlashCopy relationships

Type of application	Impact to I/O rate	Additional Weighting for FlashCopy
Application is doing no I/O	Insignificant impact	0
Application is only reading data	Insignificant impact	0
Application is only issuing random writes	Up to 50 times as much I/O	49
Application is issuing random reads and writes	Up to 15 times as much I/O	14
Application is issuing sequential reads or writes	Up to 2 times as much I/O	1

For each virtual disk that is either the source or target of an active FlashCopy relationship consider the type of application that will be using that virtual disk and record the additional weighting for that virtual disk.

For example, a FlashCopy relationship is being used to provide point in time backups. During the FlashCopy process, a host application generates an I/O workload of random reads and writes to the source virtual disk. A second host application reads the target virtual disk and writes the data to tape to create a backup. The additional weighting for the source virtual disk is 14. The additional weighting for the destination virtual disk is 0.

- Calculate the I/O rate for virtual disks in a managed disk group. Calculate the number of virtual disks in the managed disk group. Add the additional weighting for each virtual disk that is either the source or a target of an active FlashCopy relationship. Divide the I/O rate of the managed disk group by this number to give an I/O rate per VDisk.

Example 1: A managed disk group has an I/O rate of 2400 and contains 20 virtual disks. There are no FlashCopy relationships. The I/O rate per virtual disk is  $2400 / 20 = 120$ .

Example 2: A managed disk group has an I/O rate of 5000 and contains 20 virtual disks. There are two active FlashCopy relationships which have source virtual disks in this managed disk group. Both source virtual disks are being accessed by applications issuing random reads and write and hence the additional weighting for each of these virtual disks is 14. The I/O rate per virtual disk is  $5000 / ( 20 + 14 + 14 ) = 104$ .

- Determine whether the storage subsystem is overloaded. The figure determined at step 4 on page 261 provides some indication of how many I/O operations per second can be processed by each virtual disk in the managed disk group. If you know how many I/O operations per second your host applications generate you can compare these figures to determine if the system is overloaded. If you do not know how many I/O operations per second your host applications generate then you can either measure this (for example by using the I/O statistics facilities provided by the IBM Total Storage SAN Volume Controller to measure the I/O rate of your virtual disks) or use the following table as a guideline.

Table 19. Determine if the storage subsystem is overloaded

Type of Application	I/O rate per virtual disk
---------------------	---------------------------

Table 19. Determine if the storage subsystem is overloaded (continued)

Applications that generate a high I/O workload	200
Applications that generate a medium I/O workload	80
Applications that generate a low I/O workload	10

7. Interpret the result. If the I/O rate generated by the application exceeds the I/O rate you calculated per virtual disk this indicates that you could be overloading your storage subsystem and you should monitor the system carefully to see if the backend storage is actually limiting the overall performance of your system. It is also possible that the calculation above is too simplistic to model your use of storage, for example the calculation assumes that your applications generate the same I/O workload to all virtual disks.

One method you can use to monitor the performance of your storage subsystem is to use the I/O statistics facilities provided by the IBM Total Storage SAN Volume Controller to measure the I/O rate of your managed disks. Alternatively you could use the performance and I/O statistics facilities provided by your storage subsystems.

If you find your storage subsystem is over loaded there are several actions that can be take to resolve the problem:

- a. Adding more backend storage to the system will allow you to increase the quantity of I/O that can be processed by your storage subsystem. The virtualization and data migration facilities provided by the IBM Total Storage SAN Volume Controller can be used to redistribute the I/O work load of virtual disks across a greater number of managed disks without having to take the storage offline.
- b. Stop any unessential FlashCopy relationships. This will reduce the amount of I/O operations submitted to the backend storage. If you are making many FlashCopy's in parallel then consider starting less FlashCopy relationships in parallel.
- c. The I/O workload generated by a host can often be limited by adjusting the queue depth (for example, the maximum number of I/O operations that are submitted in parallel). Depending on the type of host and type of host bus adapters it may be possible to limit the queue depth per virtual disk and/or limit the queue depth per host bus adapter. An alternative method of limiting the I/O workload generated by a host would be to use the I/O governing features provided by the IBM Total Storage SAN Volume Controller. These techniques may be particularly applicable if using a mixture of different host systems to prevent one host system from saturating an I/O subsystem to the detriment of the other host systems. Note that although these techniques may be used to avoid I/O time-outs it still means the performance of your system is being limited by the amount of storage.

## Expanding a logical unit

A logical unit can be expanded using vendor-specific disk-configuration software.

Some storage subsystems enable you to expand the size of a logical unit (LU) using configuration software that is provided. However, the SAN Volume Controller cannot use extra capacity that is provided in this way. Perform the following task to ensure that this additional capacity is available to the SAN Volume Controller.

The logical unit has increased in size and this additional space must be made available for use.

Perform the following steps to ensure that this additional capacity is available to the SAN Volume Controller:

1. Issue the **svctask migrateexts** command to migrate all the data from the MDisk.

**Note:**

- a. For managed mode MDisks, issue the **svctask rmmdisk** command to remove the MDisk from the MDisk group.
  - b. For image mode MDisks, issue the **svctask chmdisk** to change the mode of the image mode disk to "unmanaged".
2. Issue the **svctask includemdisk <MDisk number>** command. Where *<MDisk number>* is the number of the MDisk that has been expanded.
  3. Issue the **svctask detectmdisk** command to re-scan the fibre-channel network for the new managed disk that you have included. This may take a few minutes.
  4. Issue the **svcinfo lsmdisk** command to display the additional capacity that has been expanded.

The extra capacity is available for use by the SAN Volume Controller.

## Modifying a logical unit mapping

You can modify a logical unit mapping.

The logical unit mapping must be modified, therefore, the logical unit number (LUN) is being changed.

1. Issue the **svctask migrateexts** command to migrate all the data from the MDisk.

**Note:**

- a. For managed mode MDisks, issue the **svctask rmmdisk** command to remove the MDisk from the MDisk group.
  - b. For image mode MDisks, issue the **svctask chmdisk** to change the mode of the image mode disk to "unmanaged".
2. De-configure the mapping on the storage subsystem so that the logical unit is not visible to the SAN Volume Controller.
  3. Issue the **svctask includemdisk <MDisk number>** command. Where *<MDisk number>* is the number of the MDisk that you want to modify.
  4. Issue the **svctask detectmdisk** command to re-scan the fibre-channel network for the managed disk that you want to rediscover. This may take a few minutes.
  5. Issue the **svcinfo lsmdisk** command to verify that the MDisk has been removed. If the MDisk is still displayed, repeat steps 3 and 4. The MDisk should now have been removed from the list of valid candidates.
  6. Configure the mapping of the logical unit to the new logical unit number.
  7. Issue the **svctask detectmdisk** command.
  8. Issue the **svcinfo lsmdisk** command to check that the MDisk candidate(s) now have the correct LUN.

The MDisk candidate(s) now have the correct LUN.

## Storage subsystem tasks using the SAN Volume Controller Console

You can determine the storage subsystem name from the SAN Volume Controller name, rename a storage subsystem, and add and remove a storage subsystem using the SAN Volume Controller Console.

### Related tasks

“Determining a storage subsystem name from its SAN Volume Controller name using the SAN Volume Controller Console”

You can determine a storage subsystem name from its SAN Volume Controller name.

“Renaming a storage subsystem”

You can rename a storage subsystem from the Renaming a Disk Controller System panel.

“Changing a configuration for an existing storage subsystem” on page 266

You must change the configuration for a storage subsystem in order to delete and replace logical units.

“Adding a new storage controller to a running configuration using the SAN Volume Controller Console” on page 266

You can add a new storage controller to your SAN at any time.

“Removing a storage subsystem using the SAN Volume Controller” on page 268

You can replace or decommission an old storage subsystem.

“Removing managed disks that represent de-configured LUs” on page 269

When de-configuring or removing LUs from your storage subsystem, the managed disks (MDisks) that represent those LUs may still exist in the cluster. Use the following procedure to remove the MDisks.

### Determining a storage subsystem name from its SAN Volume Controller name using the SAN Volume Controller Console

You can determine a storage subsystem name from its SAN Volume Controller name.

1. Click **Work with Disk Controllers**.
2. Select the name link for the storage subsystem in question. Write down the WWNN. This can be used to determine the actual storage subsystem by launching the native user interface or using the command line tools it provides to verify the actual storage subsystem that has this WWNN.

### Related information

“Storage subsystem tasks using the SAN Volume Controller Console”

You can determine the storage subsystem name from the SAN Volume Controller name, rename a storage subsystem, and add and remove a storage subsystem using the SAN Volume Controller Console.

### Renaming a storage subsystem

You can rename a storage subsystem from the Renaming a Disk Controller System panel.

Perform the following steps to rename a storage subsystem:

1. Click **Work with Managed Disks** in the portfolio.
2. Click **Disk Controller Systems** in the portfolio. The Disk Controller Systems panel is displayed.
3. Select the storage subsystem that you want to rename and select **Rename a disk controller system** from the list. Click **Go**. The Renaming a Disk Controller System panel is displayed.

### Related concepts

“Storage subsystems” on page 20

A storage subsystem is a device that coordinates and controls the operation of one or more disk drives and synchronizes the operation of the drives with the operation of the system as a whole.

#### **Related information**

“Storage subsystem tasks using the SAN Volume Controller Console” on page 265

You can determine the storage subsystem name from the SAN Volume Controller name, rename a storage subsystem, and add and remove a storage subsystem using the SAN Volume Controller Console.

## **Changing a configuration for an existing storage subsystem**

You must change the configuration for a storage subsystem in order to delete and replace logical units.

Perform the following steps to delete existing logical units (LUs) and replace them with new LUs:

1. Delete the managed disks (MDisks), that are associated with the LUs, from their MDisk groups.
2. Delete the existing LUs using the configuration software of the storage subsystem.
3. Delete the associated MDisks from the cluster by running the **svctask detectmdisk** command.
4. Configure the new LUs using the configuration software of the storage subsystem.
5. Add the new LUs to the cluster by running the **svctask detectmdisk** command.

#### **Related concepts**

“Storage subsystems” on page 20

A storage subsystem is a device that coordinates and controls the operation of one or more disk drives and synchronizes the operation of the drives with the operation of the system as a whole.

“Managed disk groups” on page 24

An *MDisk group* is a collection of MDisks that jointly contain all the data for a specified set of virtual disks (VDisks).

“Managed disks” on page 21

A managed disk (MDisk) is a logical disk (typically a RAID array or partition thereof) that a storage subsystem has exported to the SAN fabric to which the nodes in the cluster are attached.

#### **Related information**

“Storage subsystem tasks using the SAN Volume Controller Console” on page 265

You can determine the storage subsystem name from the SAN Volume Controller name, rename a storage subsystem, and add and remove a storage subsystem using the SAN Volume Controller Console.

## **Adding a new storage controller to a running configuration using the SAN Volume Controller Console**

You can add a new storage controller to your SAN at any time.

Follow the switch zoning guidelines and also ensure the controller is setup correctly for use with the SAN Volume Controller.



You should create one or more arrays on the new controller. It is recommended that you use RAID-5, RAID-1 or RAID-0+1 (sometimes called RAID-10) for maximum redundancy and reliability. Generally 5+P arrays are recommended. If your controller provides array partitioning we recommend that you create a single partition from the entire capacity available in the array, remember the LUN number that you assign to each partition as you will need this later. You should also follow the mapping guidelines (if your storage controller requires LUN mapping) to map the partitions or arrays to the SAN Volume Controller ports. You can determine the SAN Volume Controller ports by following the procedure for determining WWPNs..

1. To ensure that the cluster has detected the new storage (MDisks) click **Work with MDisks** and select the **Detect MDisks** task.
2. The controller itself will have automatically been assigned a default name. If you are unsure which controller is presenting the MDisks click **Work with Disk Controllers**. You should see a new controller listed (the one with the highest numbered default name). You must determine the storage controller name to validate that this is the correct controller.
3. Close and reopen the **Work with MDisks** panel using the filter panel to select a mode of **unmanaged** and a controller name that corresponds with the new controller's name. The MDisks shown should correspond with the RAID arrays or partitions you have created. Remember the field controller LUN number, this corresponds with the LUN number you assigned to each of the arrays or partitions.
4. It is recommended that you create a new managed disk group and add only the RAID arrays that belong to the new controller to this MDisk group. You should also avoid mixing RAID types, so for each set of RAID array types (for example, RAID-5, RAID-1) you should create a new MDisk group. Give this MDisk group an appropriate name, so if your controller is called FAST650-fred, and the MDisk group contains RAID-5 arrays, call it something like F600-fred-R5.
5. Click **Work with MDisk group** from the portfolio. Select the **Create MDisk group** task. On the new panel, enter the name you wish to give this group, select the MDisks you wish to add from the list and click **Add**. Select the extent size you wish this group to have and click **OK**.

#### **Related tasks**

“Exposing LUN's on your existing storage to the cluster via switch zoning” on page 128

You can expose LUN's on your existing storage to the cluster via switch zoning.

“Determining the WWPNs for a node using the SAN Volume Controller Console” on page 138

To determine the WWPNs of a node using the SAN Volume Controller Console, complete these steps.

#### **Related reference**

“Configuring and servicing storage subsystems” on page 253

Follow the guidelines and procedures outlined in this section to make the most of the performance available from your storage subsystems and to avoid potential I/O problems.

“Switch zoning for the SAN Volume Controller” on page 351

Consider these constraints when zoning a switch.

#### **Related information**

“Storage subsystem tasks using the SAN Volume Controller Console” on page 265

You can determine the storage subsystem name from the SAN Volume Controller name, rename a storage subsystem, and add and remove a storage subsystem using the SAN Volume Controller Console.

## Removing a storage subsystem using the SAN Volume Controller

You can replace or decommission an old storage subsystem.

All the MDisks that belong to the storage subsystem that is being decommissioned belong to a single MDisk group. You need to repeat this procedure for each MDisk group in turn before removing the old device.

This procedure takes you through adding the new device, migrating the data off of the old device and removing the old MDisks.

This function can also be performed by migrating all the VDIs that are using storage in this MDisk group to another MDisk group. This procedure has an advantage if you wish to consolidate the VDIs in a single or new group. However, you can only migrate a single VDI at a time. The procedure outlined below will migrate all the data through a single command. If you wish to migrate the VDIs however, follow the procedure for all VDIs that are using this group. You can determine the relationship between VDIs and MDisks by following the procedure.

This procedure can also be used to remove or replace a single MDisk in a group. If an MDisk has suffered a partial failure, such as a degraded array, and you can still read the data from the disk but cannot write to it, you can follow this procedure to replace just one MDisk. In steps 1 and 3, you can add or remove a single MDisk rather than a list of MDisks.

1. Add new storage.
2. Select the MDisk group that contains the old MDisks you are decommissioning. Select the **Add MDisk** task. On the task dialog, select the new MDisks from the list and click **Add**. Click **OK** to complete the task.
3. You should now have an MDisk group that contains the old MDisks (those to be decommissioned) and the new MDisks (those that are replacing them). Ensure that the capacity of the new MDisks is the same or exceeds that of the old MDisks before proceeding.
4. Force delete the old MDisks from the group. This will migrate all the data from the old MDisks to the new MDisks. Select the **Remove MDisks** task. Select the MDisks you wish to remove and click **Add**. Click **OK** to complete the task. When prompted click **Forced Delete**. Depending upon the number and size of the MDisks, and the number and size of the VDIs that are using these MDisks, this operation will take some time to complete although the task will complete immediately.
5. The only way to check progress is by using the command line interface. Issue the following command:

```
svcinfolsmigrate
```

6. When all the migration tasks have completed, for example, the command in step 5 returns no output, you can safely remove the old storage subsystem from the SAN.
7. Once you have removed the old storage subsystem from the SAN, rerun the detect MDisks task to remove the entries for the old MDisks.

### Related tasks

“Adding a new storage controller to a running configuration using the CLI” on page 270

You can add a new disk controller system to your SAN at any time using the using the command-line interface (CLI).

### Related information

“Storage subsystem tasks using the SAN Volume Controller Console” on page 265

You can determine the storage subsystem name from the SAN Volume Controller name, rename a storage subsystem, and add and remove a storage subsystem using the SAN Volume Controller Console.

### **Removing managed disks that represent de-configured LUs**

When de-configuring or removing LUs from your storage subsystem, the managed disks (MDisks) that represent those LUs may still exist in the cluster. Use the following procedure to remove the MDisks.

MDisks exist in the cluster that are no longer accessible to it. That is because the LUs that these MDisks represent have been deconfigured or removed from the storage subsystem. You should remove these MDisks.

1. Run the **svctask includemdisk** command on all the affected MDisks.
2. Run the **svctask rmmdisk** command on all affected MDisks. This puts the MDisks into the unmanaged mode.
3. Run the **svctask detectmdisk** command. The cluster detects that the MDisks no longer exist in the storage subsystem.

All of the MDisks that represent de-configured LUs are removed from the cluster.

#### **Related tasks**

“Discovering MDisks using the CLI” on page 187

You can discover MDisks using the command-line interface (CLI).

#### **Related information**

“Storage subsystem tasks using the SAN Volume Controller Console” on page 265

You can determine the storage subsystem name from the SAN Volume Controller name, rename a storage subsystem, and add and remove a storage subsystem using the SAN Volume Controller Console.

## **Controller tasks using the CLI**

You can determine the storage controller name from the SAN Volume Controller name, add and remove a controller using the command-line interface (CLI).

#### **Related tasks**

“Determining a storage subsystem name from its SAN Volume Controller name using the CLI”

You can determine a storage subsystem name from its SAN Volume Controller name using the command-line interface (CLI).

“Adding a new storage controller to a running configuration using the CLI” on page 270

You can add a new disk controller system to your SAN at any time using the using the command-line interface (CLI).

“Removing a storage subsystem using the CLI” on page 271

You can replace or decommission an old storage subsystem using the command-line interface (CLI).

### **Determining a storage subsystem name from its SAN Volume Controller name using the CLI**

You can determine a storage subsystem name from its SAN Volume Controller name using the command-line interface (CLI).

1. List the storage subsystem by issuing the following command:

```
svcinfolsccontroller
```

Remember the name or ID for the storage subsystem you want to determine.

2. For the device in question, issue the following command:

```
svcinfolsccontroller <controllername/id>
```

where *<controllername/id>* is the name or ID. Remember the WWNN for the device. Make a written record of it. The WWNN can be used to determine the actual storage subsystem by launching the native user interface or using the command line tools it provides to verify the actual storage subsystem that has this WWNN.

## **Adding a new storage controller to a running configuration using the CLI**

You can add a new disk controller system to your SAN at any time using the using the command-line interface (CLI).

You can add a new disk controller system to your SAN at any time. Follow the switch zoning guidelines in the section about switch zoning. Also, ensure the controller is setup correctly for use with the SAN Volume Controller.

You should create one or more arrays on the new controller. It is recommend that you use, RAID-5, RAID-1 or RAID-0+1 (sometimes called RAID-10) for maximum redundancy and reliability. Generally 5+P arrays are recommend. If your controller provides array partitioning we recommend that you create a single partition from the entire capacity available in the array, remember the LUN number that you assign to each partition as you will need this later. You should also follow the mapping guidelines (if your disk controller system requires LUN mapping) to map the partitions or arrays to the SAN Volume Controller ports.

1. To ensure that the cluster has detected the new storage (MDisks) issue the following command:

```
svctask detectmdisk
```

2. The controller itself will have automatically been assigned a default name. If you are unsure which controller is presenting the MDisks, list the controllers by issuing the following command:

```
svcinfolsccontroller
```

You should see a new controller listed (the one with the highest numbered default name). Remember the controller name and follow the instructions in the section about determining a disk controller system name.

3. You should give this controller a name that you can easily use to identify it. Issue the following command:

```
svctask chcontroller -name <newname> <oldname>
```

4. List the unmanaged MDisks by issuing the following command:

```
svcinfolsmdisk -filtervalue mode=unmanaged:controller_name=<new_name>
```

These MDisks should correspond with the RAID arrays or partitions you have created. Remember the field controller LUN number. This corresponds with the LUN number you assigned to each of the arrays or partitions.

5. It is recommended that you create a new managed disk group and add only the RAID arrays that belong to the new controller to this MDisk group. You should also avoid mixing RAID types, so for each set of RAID array types (for example, RAID-5, RAID-1) you should create a new MDisk group. Give this MDisk group an appropriate name, so if your controller is called FAST650-fred, and the MDisk group contains RAID-5 arrays, call it something like F600-fred-R5). Issue the following command:

```
svctask mkmdiskgrp -ext 16 -name <mdisk_grp_name>
-mdisk <colon separated list of RAID-x mdisks returned
in step 4.
```

This will create a new MDisk group with an extent size of 16MB.

#### **Related tasks**

“Determining the WWPNs of a node using the CLI” on page 200  
You can determine the WWPNs of a node using the command-line interface (CLI).

#### **Related reference**

“Configuring and servicing storage subsystems” on page 253  
Follow the guidelines and procedures outlined in this section to make the most of the performance available from your storage subsystems and to avoid potential I/O problems.

“Switch zoning for the SAN Volume Controller” on page 351  
Consider these constraints when zoning a switch.

### **Removing a storage subsystem using the CLI**

You can replace or decommission an old storage subsystem using the command-line interface (CLI).

All the MDisks that belong to the storage subsystem that is being decommissioned belong to a single MDisk group. You need to repeat this procedure for each MDisk group in turn before removing the old device.

This procedure takes you through adding the new device, migrating the data off of the old device and removing the old MDisks.

This function can also be performed by migrating all the VDisks that are using storage in this MDisk group to another MDisk group. This procedure has an advantage if you wish to consolidate the VDisks in a single or new group. However, you can only migrate a single VDisk at a time. The procedure outlined below will migrate all the data through a single command.

This procedure can also be used to remove or replace a single MDisk in a group. If an MDisk has suffered a partial failure, such as a degraded array, and you can still read the data from the disk but cannot write to it, you can follow this procedure to replace just one MDisk. In the following procedure, add or remove a single MDisk rather than a list of MDisks.

1. Add the new storage subsystem to your cluster configuration.
2. Issue the following command:

```
svctask addmdisk -mdisk <colon separated mdisk
list as determined in step 4> <mdisk_grp_name>
```

Where *<mdisk\_grp\_name>* is the name of the MDisk group that contains the MDisks that are being decommissioned.

3. You should now have an MDisk group that contains the old MDisks (those to be decommissioned) and the new MDisks (those that are replacing them). Ensure that the capacity of the new MDisks is the same or exceeds that of the old MDisks before proceeding.
4. Force delete the old MDisks from the group. This will migrate all the data from the old MDisks to the new MDisks. Issue the following command:

```
svctask rmmdisk -force -mdisk <colon separated  
mdisk list of all the old mdisks> <mdisk_grp_name>
```

Depending upon the number and size of the MDisks, and the number and size of the VDIsks that are using these MDisks, this operation will take some time to complete although the command will return immediately.

5. Check progress by issuing the following command:

```
svcinfolsmigrate
```

6. When all the migration tasks have completed, for example, the command in step 4 returns no output, you can safely remove the old device from the SAN.
7. Once you have removed the old device from the SAN, rerun the **svctask detectmdisk** command to remove the entries for the old MDisks.

#### **Related tasks**

“Removing a storage subsystem using the CLI” on page 271

You can replace or decommission an old storage subsystem using the command-line interface (CLI).

“Determining the relationship between VDIsks and MDisks using the CLI” on page 202

You can determine the relationship between VDIsks and MDisks using the command-line interface (CLI).

“Migrating VDIsks between MDisk groups using the CLI” on page 219

You can migrate VDIsks between MDisk groups using the command-line interface (CLI).

## **Creating a quorum disk**

A quorum disk is used to resolve tie-break situations when the “voting set” of nodes disagree on the current cluster state.

### **Quorum disk creation and extent allocation**

During discovery, LUs are assessed to determine their potential for use as a quorum disk. From the set of eligible LUs, three candidates are proposed and one is selected. To be considered eligible as a quorum disk, an LU must meet the following criteria:

- It must be presented by a storage subsystem that is an approved host for quorum disks.
- It must be in managed space mode.
- It must have sufficient free extents to hold the cluster state and the configuration metadata.
- It must be visible to all nodes in the cluster.

When discovery completes, the following takes place:

- If there are no LUs in managed space mode, then there will be no quorum disk candidates and **no error is logged**.
- If there are no LUs in managed space mode, but no quorum disk candidates, then an error will be logged.

If possible, the quorum disk candidates will be presented by different devices. Once the quorum disk has been chosen, no attempt is made to ensure that the other candidates are presented via different devices. The set of quorum disk candidates can be updated by configuration activity, assuming that other eligible LUs are available.

## Manual discovery

When creating or removing LUNs on a storage subsystem, the MDisk view will not be automatically updated. It must be updated manually.

To ensure that the MDisk view is updated, type **svctask detectmdisk** to start a manual discovery.

## Servicing storage subsystems

When servicing your storage subsystems, it is imperative that you follow the service instructions contained in the vendor documentation.

If the instructions state that all I/O operations be stopped for a particular service action, ensure that the SAN Volume Controller has terminated all FlashCopy activity and that all data migration requests are complete.

---

## Configuring the EMC CLARiiON subsystem

This part provides information about configuring the EMC CLARiiON storage system for its attachment to a SAN Volume Controller.

### Related concepts

“Managed disk groups” on page 24

An *MDisk group* is a collection of MDisks that jointly contain all the data for a specified set of virtual disks (VDisks).

### Related tasks

“Configuring the EMC CLARiiON controller with Access Logix installed” on page 274

To configure the EMC CLARiiON controller that has Access Logix installed on it, complete these tasks.

“Configuring the EMC CLARiiON controller (Access Logix not installed)” on page 277

To configure an EMC CLARiiON controller that does not have Access Logix installed, complete these steps.

“Creating managed disk groups” on page 125

You can create a new managed disk (MDisk) group using the Create a Managed Disk Group wizard.

### Related reference

“Access Logix” on page 274

Access Logix is an optional feature of the firmware code. This provides the functionality that is known as LUN Mapping or LUN Virtualization.

“Supported models of the EMC CLARiiON” on page 277

The following table lists the supported models of the EMC CLARiiON.

“Supported firmware levels for the EMC CLARiiON” on page 278  
See the following Web site for specific firmware levels and the latest supported hardware. <http://www-1.ibm.com/servers/storage/support/virtual/2145.html>

“Concurrent maintenance on the EMC CLARiiON” on page 278  
Concurrent maintenance of the EMC CLARiiON is supported with the SAN Volume Controller.

“User interface on CLARiiON” on page 278  
Ensure that you are familiar with the user interface which supports the CLARiiON subsystem.

“Sharing the EMC CLARiiON between a host and the SAN Volume Controller” on page 279  
The EMC CLARiiON can be shared between a host and a SAN Volume Controller.

“Switch zoning limitations for the EMC CLARiiON” on page 279  
There are limitations in switch zoning for the SAN Volume Controller and EMC CLARiiON.

“Quorum disks on the EMC CLARiiON” on page 280  
This topic provides information about quorum disks on the EMC CLARiiON.

“Advanced functions for the EMC CLARiiON” on page 280  
Some EMC CLARiiON advanced functions are not compatible with the SAN Volume Controller.

“Logical unit creation and deletion on the EMC CLARiiON” on page 281  
Binding an LU to a RAID group can take a significant amount of time on the EMC CLARiiON.

“Configuring settings for the EMC CLARiiON” on page 281  
A number of settings and options that are available through the EMC CLARiiON configuration interface.

## Access Logix

Access Logix is an optional feature of the firmware code. This provides the functionality that is known as LUN Mapping or LUN Virtualization.

It is possible to determine whether Access Logix is installed using the SAN Volume Controller Console via the software tab in the storage subsystem properties page. Once Access Logix is installed it can be disabled but not removed. This gives two modes of operation, as follows:

- **Access Logix not installed:** In this mode, all LUNs are accessible from all target ports by any host. Therefore, the SAN fabric must be zoned to ensure that only the SAN Volume Controller can access the target ports.
- **Access Logix enabled:** In this mode of operation, a storage group can be formed from a set of LUNs. Only the hosts assigned to the storage group are allowed access to these LUNs.

## Configuring the EMC CLARiiON controller with Access Logix installed

To configure the EMC CLARiiON controller that has Access Logix installed on it, complete these tasks.

It is assumed at this point that the EMC CLARiiON controller is not connected to the SAN Volume Controller. It is also assumed that you already have a RAID controller with logical units and you've identified which LUs will be presented to the SAN Volume Controller.



With Access Logix installed, the SAN Volume Controller will not have access to the storage controllers LUs. In order to give SAN Volume Controller access to a LU, the SAN Volume Controller and LU must be associated using the EMC CLARiiON configuration tools. The association is formed by creating a Storage Group containing the LU and the SAN Volume Controller.

**Related tasks**

“Configuring your storage groups” on page 276

To allow the SAN Volume Controller to access LUs configured on the EMC CLARiiON controller, complete these steps.

**Registering the SAN Volume Controller Ports with your EMC CLARiiON**

To register SAN Volume Controller ports with an EMC CLARiiON controller that has Access Logix installed, complete these steps.

At this point, the EMC CLARiiON controller is not connected to the SAN Volume Controller. It is assume you already have a RAID controller with logical units (LUs) and you’ve identified which LUs will be presented to the SAN Volume Controller.

Each initiator port (WWPN) must be registered against a host name and against a target port to which access is granted. These associations are listed in the following table.

If a host has multiple initiator ports, there will be multiple table entries with the same host name. If a host is allowed access via multiple target ports, there will be multiple table entries. For SAN Volume Controller hosts, it is recommended that all WWPN entries carry the same host name.

Option	EMC CLARiiON Default Setting	SAN Volume Controller Required Setting
WWPN	n/a	Any
WWN	n/a	Any
Host name	n/a	Any
SP port	n/a	Any
Initiator type	3	3
ArrayCommPath	enable	disable
Failover mode	0	2
Unit Serial Number	array	Any

1. Connect the fibre channel and zone the fabric as required.
2. Issue an **svctask detectmdisk** command .
3. From the Enterprise Storage window, right-click on the storage subsystem.
4. Select **Connectivity Status**. The Connectivity Status window is displayed.
5. Click **New**. The Create Initiator Record window is displayed.
6. Wait for the list of SAN Volume Controller ports to appear in the dialog box. (Identify them from the WWPN.) This can take several minutes.
7. Click **Group Edit**.
8. Select all instances of all the SAN Volume Controller ports in the Available dialog box. Then click the right arrow to move them to the selected box.
9. Fill in the HBA WWN field. You must know the following information:
  - a. WWNN of each SAN Volume Controller in the cluster

- b. WWPN of each port ID for each node on the cluster

The HBA WWN field is made up of the WWNN and the WWPN for the SAN Volume Controller port. The following output shows an example:

```
50:05:07:68:01:00:8B:D8:50:05:07:68:01:20:8B:D8
```

10. Select **A** in the field marked SP and **0** in the SP Port field.
11. For the Initiator Type field, select **CLARiiON Open** in the drop down list.
12. Deselect the ArrayCommPath checkbox if it has been selected.
13. Select **2** from the Failover Mode field drop down list.
- 14.

**Note:** Failure to select failover mode 2 will prevent SVC from being able to failover I/O. Your data may become unavailable in the event of a single failure.

**Note:**

- a. If this is the first time that a port has been registered, ensure that you select the New Host option. Otherwise, select Existing Host.
  - b. Ensure that the same host name is entered for each port that is registered.
15. Assign a host name in the Host Name field.
  16. Click **OK**.
  17. Specify the IP address of your switch. The EMC CLARiiON will not use this IP address. However it must be unique (within the EMC CLARiiON) to prevent errant behavior by Navisphere.
  18. Perform step 10 for all possible combinations. The following example shows the different combinations of a subsystem with four ports:
    - a. SP: A SP Port: 0
    - b. SP: A SP Port: 1
    - c. SP: B SP Port: 0
    - d. SP: B SP Port: 1
  19. Refer to steps 1 on page 275 through 18 to register the rest of your SAN Volume Controller WWPNs.

All your WWPNs are registered against the host name that you specified.

**Related tasks**

“Adding nodes to a cluster using the CLI” on page 181  
You can add nodes to a cluster .

**Configuring your storage groups**

To allow the SAN Volume Controller to access LUs configured on the EMC CLARiiON controller, complete these steps.

LUN mapping is provided by Access Logix in the following manner:

**Note:** Storage groups can only be configured if Access Logix is installed and enabled.

- A subset of LUs can form a storage group.
- An LU can be in multiple storage groups.
- A host can be added to a storage group. This host has access to all LUs in the storage group.

- A host *cannot* be added to a second storage group.
1. From the Enterprise Storage window, right-click on the storage subsystem.
  2. Select **Create Storage Group**. The Create Storage Group window is displayed.
  3. Choose a name for your storage group. Enter this name in the Storage Group Name field.
  4. Select **Dedicated** in the Sharing State field.
  5. Click **OK**. The storage group has been created.
  6. From the Enterprise Storage window, right-click the storage group that was just created.
  7. Select **Properties**. The Storage Group Properties window is displayed.
  8. From the Storage Group Properties window, perform the following steps:
    - a. Select the **LUNs** tab.
    - b. Select the LUNs you want SAN Volume Controller to manage in the Available LUNs table.
 

**Attention:** Ensure that the logical units that you have selected are not used by another storage group.
    - c. Click the forward arrow button.
    - d. Click **Apply**. A Confirmation window is displayed.
    - e. Click **Yes** to continue. A Success window is displayed.
    - f. Click **OK**.
    - g. Select the **Hosts** tab.
    - h. Select the host you created from step 14 on page 276.
 

**Attention:** Ensure only SAN Volume Controller hosts (initiator ports) are in the storage group.
    - i. Click the forward arrow button.
    - j. Click **OK**. The Confirmation window is displayed.
    - k. Click **Yes** to continue. A Success window is displayed.
    - l. Click **OK**.

## Configuring the EMC CLARiiON controller (Access Logix not installed)

To configure an EMC CLARiiON controller that does not have Access Logix installed, complete these steps.

If Access Logix is not installed on an EMC CLARiiON controller, all LUs that were created on the controller may be used by the SAN Volume Controller. No further configuration of the EMC CLARiiON controller is necessary.

Configure the switch zoning such that no hosts can access these LUs.

### Related reference

“Switch zoning for the SAN Volume Controller” on page 351  
Consider these constraints when zoning a switch.

## Supported models of the EMC CLARiiON

The following table lists the supported models of the EMC CLARiiON.

Table 20. Supported models of the EMC CLARiiON

Model
FC4700-1
FC4700-2

Table 20. Supported models of the EMC CLARiiON (continued)

Model
CX200
CX400
CX600

## Supported firmware levels for the EMC CLARiiON

See the following Web site for specific firmware levels and the latest supported hardware. <http://www-1.ibm.com/servers/storage/support/virtual/2145.html>

## Concurrent maintenance on the EMC CLARiiON

Concurrent maintenance of the EMC CLARiiON is supported with the SAN Volume Controller.

Concurrent maintenance is the ability to perform I/O operations to a controller while simultaneously performing maintenance on it. This topic lists the components of the EMC CLARiiON that can be maintained in this way.

The EMC CLARiiON model FC series allows for concurrent replacement of the following components:

- Disk drives
- Controller fans (Fans must be replaced within 2 minutes or controllers will shut down.)
- Disk enclosure fans (Fans must be replaced within 2 minutes or controllers will shut down.)
- Controller (Service Processor: cache must be disabled first)
- Fibre Channel Bypass cards (LCC)
- Power supplies (Fans must be removed first.)
- UPS battery (SPS)

The EMC CLARiiON model CX series allows for concurrent replacement of the following components:

- Disk drives
- Controller (Service processor or drawer controller)
- Power/cooling modules (Modules must be replaced within 2 minutes or controllers will shut down.)
- UPS battery (SPS)

### Note:

1. EMC CLARiiON procedures for concurrent upgrade must be followed in all cases.
2. The CX Series also has a feature called Data In Place Upgrade which allows you to upgrade from one model to another (for example, from the CX200 to the CX600) with no data loss or migration required. This is **not** supported by the SAN Volume Controller.

## User interface on CLARiiON

Ensure that you are familiar with the user interface which supports the CLARiiON subsystem.

## NaviSphere or Navicli

The EMC CLARiiON is configured to either use a Java user interface called NaviSphere or from a CLI tool called Navicli. The user interface is accessible from any Web browser by entering the IP address of either controller into the URL box. The CLI is installed as part of the NaviSphere Agent software (host software).

**Note:** Some options and features are only accessible through the CLI.

Communication with the controller in both cases is out-of-band. Therefore, the host does not need to be connected to the storage over fibre-channel and moreover must not be connected without Access Logix.

## Web Server

A Web server is running on each of the controllers on the subsystem. During normal operation, the user interface only allows basic monitoring of the subsystem and displays an error log. If a controller is put into diagnostic mode by pressing the reset button on the controller, the user interface allows for firmware upgrades and subsystem configuration resets.

## Sharing the EMC CLARiiON between a host and the SAN Volume Controller

The EMC CLARiiON can be shared between a host and a SAN Volume Controller.

- Split controller access is only supported when Access Logix is installed and enabled.
- A host cannot be connected to both the SAN Volume Controller and EMC CLARiiON at the same time.
- LUs must not be shared between a host and a SAN Volume Controller.
- Partitions in a RAID group must not be shared between a host and a SAN Volume Controller.

### Related concepts

“Storage subsystems” on page 51

Follow these rules when planning the configuration of storage subsystems in the SAN fabric.

## Switch zoning limitations for the EMC CLARiiON

There are limitations in switch zoning for the SAN Volume Controller and EMC CLARiiON.

The number of connections (process logins) consumed by the SAN Volume Controller cluster and the EMC CLARiiON must be carefully considered. For a single fabric, the number of connections is:

- Number of SAN Volume Controller nodes \* the number of initiator ports \* the number of target ports

If this exceeds the subsystem capabilities, the solution is to reduce the number of initiator or target ports in the configuration, without introducing a single point of failure.

- When reducing the number of *initiator* ports, use only two of the four ports on each SAN Volume Controller node (one per HBA) and configure two fabrics, or fabric zones, such that these are the only initiator ports visible to each target port.

- When reducing the number of *target* ports, ensure that ports from more than one controller are used.

The EMC CLARiiON CX200 provides 2 ports and supports 30 connections. Using a single SAN fabric, a 4-node cluster requires 32 connections ( $4 * 4 * 2$ ). This exceeds the CX200 capability and exposes the SAN Volume Controller cluster integrity. Since there are only two target ports available, the solution is to reduce the number of initiator ports. This consumes only 16 of the available 30 connections.

**Note:** The EMC CLARiiON CX200 cannot be used in an 8-node cluster configuration because the number of initiator ports cannot be reduced below 16 (2 per node) and the number of target ports cannot be reduced below 2. This consumes 32 connections and still exceeds the subsystem limit.

EMC CLARiiON FC4700 and CX400 systems provide 4 target ports and support 64 connections. Using a single SAN fabric, a 4-node cluster requires 64 connections ( $4 * 4 * 4$ ). This equals the EMC CLARiiON capabilities and is therefore only a problem if split support with other hosts is required. Reducing either the number of initiator ports or target ports consumes 32 of the available 64 connections.

EMC CLARiiON CX600 provides 8 target ports and supports 128 connections. A 4-node cluster consumes all 128 connections ( $4 * 4 * 8$ ). An 8-node cluster exceeds the connection limit and one of the reduction schemes must be used.

**Related reference**

“Switch zoning for the SAN Volume Controller” on page 351  
Consider these constraints when zoning a switch.

## Quorum disks on the EMC CLARiiON

This topic provides information about quorum disks on the EMC CLARiiON.

The EMC CLARiiON supports quorum disks.

A SAN Volume Controller configuration that only includes the EMC CLARiiON is permitted

**Related reference**

“Configuring and servicing storage subsystems” on page 253  
Follow the guidelines and procedures outlined in this section to make the most of the performance available from your storage subsystems and to avoid potential I/O problems.

**Related information**

“Creating a quorum disk” on page 272  
A quorum disk is used to resolve tie-break situations when the “voting set” of nodes disagree on the current cluster state.

## Advanced functions for the EMC CLARiiON

Some EMC CLARiiON advanced functions are not compatible with the SAN Volume Controller.

### **Flash Copy and SnapView**

The EMC CLARiiON's form of FlashCopy called SnapView is not supported by the SAN Volume Controller. In a split controller configuration, SnapView is not supported even for the LUs that are controlled by the host.

### **Remote Copy and MirrorView**

The EMC CLARiiON's form of Remote Copy called MirrorView is not supported by the SAN Volume Controller. In a split controller configuration, MirrorView is not supported even for the LUs that are controlled by the host.

### **SAN Copy**

The EMC CLARiiON provides a form of Flash Copy called SAN Copy which is not supported by the SAN Volume Controller. In a split controller configuration, SAN Copy is not supported even for the LUs that are controlled by the host.

### **MetaLUN**

MetaLUN allows an LU to be expanded using LUs in other RAID groups. The SAN Volume Controller supports MetaLUN for migration purposes in Image Mode only.

## **Logical unit creation and deletion on the EMC CLARiiON**

Binding an LU to a RAID group can take a significant amount of time on the EMC CLARiiON.

The LU must not be added to a storage group until binding is complete. As a safeguard, the SAN Volume Controller will not discover the LU if binding is in progress. A subsequent manual discovery is required.

#### **Related tasks**

“Discovering MDisks using the CLI” on page 187

You can discover MDisks using the command-line interface (CLI).

## **Configuring settings for the EMC CLARiiON**

A number of settings and options that are available through the EMC CLARiiON configuration interface.

Some of the options and settings are supported by the SAN Volume Controller. These options and settings cover the following:

- Subsystem
- Port
- Logical unit

#### **Related reference**

“Global settings for the EMC CLARiiON” on page 282

Global settings apply across an EMC CLARiiON subsystem.

“Controller settings for the EMC CLARiiON” on page 282

Controller settings are settings that apply across one EMC CLARiiON subsystem.

“Port settings for the EMC CLARiiON” on page 283

Port settings are configurable at the port level.

“LU settings for the EMC CLARiiON” on page 283  
 LU settings are configurable at the LU level.

## Global settings for the EMC CLARiiON

Global settings apply across an EMC CLARiiON subsystem.

Table 21. EMC CLARiiON global settings supported by the SAN Volume Controller

Option	EMC CLARiiON Default Setting	SAN Volume Controller Required Setting
Access Controls (Access Logix installed)	Not installed	Either Installed or Not Installed
Subsystem Package Type	3	3
Queue Full Status	Disable	Disable
Recovered Errors	Disable	Disable
Target Negotiate	Displays the state of the target negotiate bit.	Displays the state of the target negotiate bit.
Mode Page 8 Info	Disable	Disable
Base UUID	0	0
Write Cache Enabled	Enabled	Enabled
Mirrored Write Cache	Enabled	Enabled
Write Cache Size	600 MB	Default recommended
Enable Watermarks	Enabled	Enabled
Cache High Watermark	96%	Default
Cache Low Watermark	80%	Default
Cache Page Size	4 Kb	4 Kb
RAID3 Write Buffer Enable	Enable	Default recommended
RAID3 Write Buffer	0 MB	Default recommended

### Related concepts

“Storage subsystems” on page 20

A storage subsystem is a device that coordinates and controls the operation of one or more disk drives and synchronizes the operation of the drives with the operation of the system as a whole.

### Related tasks

“Configuring a balanced storage subsystem” on page 260

The attachment of a storage subsystem to a SAN Volume Controller requires that some specific settings be applied to the device, some limitations are also listed for each storage type.

## Controller settings for the EMC CLARiiON

Controller settings are settings that apply across one EMC CLARiiON subsystem.

Table 22 describes the options that can be set by the EMC CLARiiON.

Table 22. EMC CLARiiON controller settings supported by the SAN Volume Controller

Option	EMC CLARiiON Default Setting	SAN Volume Controller Required Setting
Read Cache Enabled	Enable	Enable
Read Cache Size	200 MB	Enable



Table 22. EMC CLARiiON controller settings supported by the SAN Volume Controller (continued)

Option	EMC CLARiiON Default Setting	SAN Volume Controller Required Setting
Statistics Logging	Disable	Either Enable or Disable

**Note:** The SAN Volume Controller cannot obtain or change the configuration options listed above. It is therefore your responsibility to configure the options as recommended.

#### Related concepts

“Storage subsystems” on page 20

A storage subsystem is a device that coordinates and controls the operation of one or more disk drives and synchronizes the operation of the drives with the operation of the system as a whole.

#### Related tasks

“Configuring a balanced storage subsystem” on page 260

The attachment of a storage subsystem to a SAN Volume Controller requires that some specific settings be applied to the device, some limitations are also listed for each storage type.

## Port settings for the EMC CLARiiON

Port settings are configurable at the port level.

This topic lists port settings, the EMC CLARiiON defaults, and the required settings for the SAN Volume Controller.

Table 23. EMC CLARiiON port settings supported by the SAN Volume Controller

Option	EMC CLARiiON Default Setting	SAN Volume Controller Required Setting
Port speed	2 GB	Either 1 or 2 GB

**Note:** The SAN Volume Controller cannot obtain or change the configuration options listed above. It is therefore your responsibility to configure the options as recommended.

#### Related concepts

“Storage subsystems” on page 20

A storage subsystem is a device that coordinates and controls the operation of one or more disk drives and synchronizes the operation of the drives with the operation of the system as a whole.

“Virtual disk-to-host mapping” on page 30

Virtual disk-to-host mapping is the process of controlling which hosts have access to specific virtual disks (VDisks) within the SAN Volume Controller.

#### Related tasks

“Configuring a balanced storage subsystem” on page 260

The attachment of a storage subsystem to a SAN Volume Controller requires that some specific settings be applied to the device, some limitations are also listed for each storage type.

## LU settings for the EMC CLARiiON

LU settings are configurable at the LU level.

This topic lists EMC CLARiiON defaults and required settings are for the SAN Volume Controller.

Table 24 describes the options that must be set for each logical unit that is accessed by the SAN Volume Controller. LUs that are accessed by hosts can be configured differently.

*Table 24. EMC CLARiiON LU settings supported by the SAN Volume Controller*

<b>Option</b>	<b>EMC CLARiiON Default Setting</b>	<b>SAN Volume Controller Required Setting</b>
LU ID	Auto	N/A
RAID Type	5	Any RAID Group
RAID Group	Any available RAID Group	Any available RAID Group
Offset	0	Any setting
LU Size	ALL LBAs in RAID Group	Any setting
Placement	Best Fit	Either Best Fit or First Fit
UID	N/A	N/A
Default Owner	Auto	N/A
Auto Assignment	Disabled	Disabled
Verify Priority	ASAP	N/A
Rebuild Priority	ASAP	N/A
Strip Element Size	128	N/A
Read Cache Enabled	Enabled	Enabled
Write Cache Enabled	Enabled	Enabled
Idle Threshold	0–254	0–254
Max Prefetch Blocks	0–2048	0–2048
Maximum Prefetch IO	0–100	0–100
Minimum Prefetch Size	0–65534	0–65534
Prefetch Type	0, 1, or 2	0, 1, or 2
Prefetch Multiplier	0 to 2048 or 0 to 324	0 to 2048 or 0 to 324
Retain prefetch	Enabled or Disabled	Enabled or Disabled
Prefetch Segment Size	0 to 2048 or 0 to 32	0 to 2048 or 0 to 32
Idle Delay Time	0 to 254	0 to 254
Verify Priority	ASAP, High, Medium, or Low	Low
Write Aside	16 to 65534	16 to 65534

**Note:** The SAN Volume Controller cannot obtain or change the configuration options listed above. It is therefore your responsibility to configure the options as recommended.

**Related concepts**

“Storage subsystems” on page 20

A storage subsystem is a device that coordinates and controls the operation of one or more disk drives and synchronizes the operation of the drives with the operation of the system as a whole.

**Related tasks**

“Configuring a balanced storage subsystem” on page 260  
The attachment of a storage subsystem to a SAN Volume Controller requires that some specific settings be applied to the device, some limitations are also listed for each storage type.

---

## Configuring the EMC Symmetrix subsystem

This part provides information about configuring the EMC Symmetrix, for attachment to a SAN Volume Controller.

### Related reference

“Supported models of the EMC Symmetrix controller”

The following table lists the supported models of the EMC Symmetrix controller.

“Supported firmware levels for the EMC Symmetrix controller” on page 286

See the following Web site for specific firmware levels and the latest supported hardware. <http://www-1.ibm.com/servers/storage/support/virtual/2145.html>

“Concurrent maintenance on the EMC Symmetrix” on page 286

Concurrent maintenance is the capability to perform I/O operations to an EMC Symmetrix while simultaneously performing maintenance operations on it.

“User interface on Symmetrix” on page 287

Ensure that you are familiar with the user interface which supports the Symmetrix subsystem.

“Sharing the EMC Symmetrix controller between a host and the SAN Volume Controller” on page 287

The EMC Symmetrix can be shared between a host and a SAN Volume Controller.

“Switch zoning limitations for the EMC Symmetrix” on page 288

Consider the following limitations when planning switch zoning and connecting to the SAN.

“Quorum disks on EMC Symmetrix” on page 288

Managed disks presented by the EMC Symmetrix will be chosen by the SAN Volume Controller as quorum disks.

“Advanced functions for EMC Symmetrix” on page 289

Advanced copy functions for Symmetrix (for example, SRDF and TimeFinder) are NOT supported for disks managed by the SAN Volume Controller since the copy does not extend to the SAN Volume Controller cache.

“Logical unit creation and deletion on EMC Symmetrix” on page 289

An LU exported by Symmetrix, meaning it is visible to a host, is either a *Symmetrix device* or a *Meta device*.

“Configuration interface for the EMC Symmetrix” on page 290

EMC Symmetrix provides applications for configuring, monitoring and controlling the Symmetrix system.

“Configuring settings for the EMC Symmetrix” on page 290

A number of settings and options are available through the EMC Symmetrix configuration interface.

## Supported models of the EMC Symmetrix controller

The following table lists the supported models of the EMC Symmetrix controller.

Table 25. Supported models of the EMC Symmetrix

Model
Symmetrix 8000 (Symm 5)-8130

Table 25. Supported models of the EMC Symmetrix (continued)

Model
Symmetrix 8000 (Symm 5)-8230
Symmetrix 8000 (Symm 5)-8430
Symmetrix 8000 (Symm 5)-8530
Symmetrix 8000 (Symm 5)-8730
Symmetrix 8000 (Symm 5)-8830

**Related reference**

“Configuring the EMC Symmetrix subsystem” on page 285  
This part provides information about configuring the EMC Symmetrix, for attachment to a SAN Volume Controller.

## Supported firmware levels for the EMC Symmetrix controller

See the following Web site for specific firmware levels and the latest supported hardware. <http://www-1.ibm.com/servers/storage/support/virtual/2145.html>

**Related reference**

“Configuring the EMC Symmetrix subsystem” on page 285  
This part provides information about configuring the EMC Symmetrix, for attachment to a SAN Volume Controller.

## Concurrent maintenance on the EMC Symmetrix

Concurrent maintenance is the capability to perform I/O operations to an EMC Symmetrix while simultaneously performing maintenance operations on it.

This topic lists the components of the EMC Symmetrix that can be maintained in this way. Symmetrix supports non-disruptive microcode upgrade procedures.

The EMC Symmetrix is an Enterprise class device that supports non-disruptive replacement of the following components:

- Channel Director
- Disk Director
- Cache card
- Disk drive
- Cooling fan
- Comms card
- EPO card
- Operator panel
- PSU
- Service Processor
- Batteries
- Ethernet hub

Service actions and upgrade procedures may only be performed by an EMC Customer Engineer. Consequently, concurrent maintenance of Symmetrix is not supported by the SAN Volume Controller. Concurrent code upgrade under the SAN Volume Controller is also not supported.

**Related reference**

“Configuring the EMC Symmetrix subsystem” on page 285  
This part provides information about configuring the EMC Symmetrix, for attachment to a SAN Volume Controller.

## User interface on Symmetrix

Ensure that you are familiar with the user interface which supports the Symmetrix subsystem.

### EMC Control Center

A basic Symmetrix configuration is performed by an EMC Customer Engineer (CE) via the Symmetrix service processor. The CE defines the storage device types and sets the configurable options. The user is then able to configure and control the exported storage as described below.

The EMC Control Center allows the Symmetrix storage to be managed and monitored.

Volume Logix is a volume configuration management tool. It provides control over access rights to the storage when multiple hosts share target ports.

### Command-line interface

The Symmetrix Command Line Interface (SYMCLI) allows the server to monitor and control Symmetrix.

#### Related reference

“Configuring the EMC Symmetrix subsystem” on page 285  
This part provides information about configuring the EMC Symmetrix, for attachment to a SAN Volume Controller.

## Sharing the EMC Symmetrix controller between a host and the SAN Volume Controller

The EMC Symmetrix can be shared between a host and a SAN Volume Controller.

This topic briefly discusses the restrictions.

- Target ports must not be shared between the SAN Volume Controller and other hosts.
- A single host must not be connected to a SAN Volume Controller and a Symmetrix because the multi-pathing drivers (for example, Subsystem Device Driver (SDD) and PowerPath), do not coexist.
- Other hosts may be connected directly to Symmetrix at the same time as SAN Volume Controller, under the following conditions:
  - The fabric must be zoned such that other hosts cannot access the target ports used by the SAN Volume Controller.
  - Symmetrix must be configured such that other hosts cannot access the LUs that are managed by the SAN Volume Controller.

#### Related concepts

“Storage subsystems” on page 51  
Follow these rules when planning the configuration of storage subsystems in the SAN fabric.

#### Related reference

“Configuring the EMC Symmetrix subsystem” on page 285  
This part provides information about configuring the EMC Symmetrix, for attachment to a SAN Volume Controller.

## Switch zoning limitations for the EMC Symmetrix

Consider the following limitations when planning switch zoning and connecting to the SAN.

### Switch zoning

The SAN Volume Controller switch zone must include at least one target port on two or more fibre-channel adapters (FAs) in order to have no single point of failure.

### Connecting to the SAN

The Symmetrix connects to the SAN via a fibre-channel director. Directors are installed in pairs and each consists of two boards, one of which is a fibre-channel adapter (FA). The FA provides 2 - 12 target ports. Symmetrix assigns a WWNN per target port and SAN Volume Controller can resolve up to four WWNN's per subsystem. In order to connect more than four target ports to a SAN Volume Controller, the following procedure must be performed:

1. Divide the set of target ports into groups of 2 - 4.
2. Define a discrete set of logical units for each group.
3. Map the logical units to each target port in their group.

The SAN Volume Controller views each group of target ports as a separate subsystem. Ensure that no LUs are a member of more than one group.

#### Related reference

“Configuring the EMC Symmetrix subsystem” on page 285  
This part provides information about configuring the EMC Symmetrix, for attachment to a SAN Volume Controller.

“Switch zoning for the SAN Volume Controller” on page 351  
Consider these constraints when zoning a switch.

## Quorum disks on EMC Symmetrix

Managed disks presented by the EMC Symmetrix will be chosen by the SAN Volume Controller as quorum disks.

This topic discusses the implications.

The SAN Volume Controller uses a logical unit (LU) presented by an EMC Symmetrix as a quorum disk. In addition, it will provide a quorum disk, even if the connection is by a single port.

#### Related reference

“Configuring the EMC Symmetrix subsystem” on page 285  
This part provides information about configuring the EMC Symmetrix, for attachment to a SAN Volume Controller.

“Configuring and servicing storage subsystems” on page 253  
Follow the guidelines and procedures outlined in this section to make the most of the performance available from your storage subsystems and to avoid potential I/O problems.

## Advanced functions for EMC Symmetrix

Advanced copy functions for Symmetrix (for example, SRDF and TimeFinder) are NOT supported for disks managed by the SAN Volume Controller since the copy does not extend to the SAN Volume Controller cache.

### Related reference

“Configuring the EMC Symmetrix subsystem” on page 285

This part provides information about configuring the EMC Symmetrix, for attachment to a SAN Volume Controller.

## Logical unit creation and deletion on EMC Symmetrix

An LU exported by Symmetrix, meaning it is visible to a host, is either a *Symmetrix device* or a *Meta device*.

*Symmetrix device* is an EMC term for an LU that is hosted by a Symmetrix. These are all emulated devices and have exactly the same characteristics:

- N cylinders
- 15 tracks per cylinder
- 64 logical blocks per track
- 512 bytes per logical block

Symmetrix devices can be created using the **create dev** command from the Symmetrix Command Line Interface (SYMCLI). The configuration of an LU can be changed using the **convert dev** command from the Symmetrix Command Line Interface (SYMCLI). Each physical storage device in a Symmetrix is partitioned into 1 - 128 hyper-volumes or hypers. Each hyper may be up to 16GB. A Symmetrix device maps to one or more hypers, depending on how it is configured. For example:

- Hypers may be mirrored (2-way, 3-way, 4-way)
- Hypers may be formed into RAID-S groups

*Meta device* is an EMC term for a concatenated chain of Symmetrix devices. This enables Symmetrix to provide logical units that are larger than a hyper. Up to 255 hypers may be concatenated to form a single meta device. Meta devices can be created using the **form meta** and **add dev** commands from the Symmetrix Command Line Interface (SYMCLI).

### Related concepts

“Storage subsystems” on page 20

A storage subsystem is a device that coordinates and controls the operation of one or more disk drives and synchronizes the operation of the drives with the operation of the system as a whole.

### Related tasks

“Configuring a balanced storage subsystem” on page 260

The attachment of a storage subsystem to a SAN Volume Controller requires that some specific settings be applied to the device, some limitations are also listed for each storage type.

### Related reference

“Configuring the EMC Symmetrix subsystem” on page 285

This part provides information about configuring the EMC Symmetrix, for attachment to a SAN Volume Controller.

## Configuration interface for the EMC Symmetrix

EMC Symmetrix provides applications for configuring, monitoring and controlling the Symmetrix system.

A basic Symmetrix configuration is performed by an EMC Customer Engineer (CE) via the Symmetrix service processor. The CE defines the storage device types and sets the configurable options. The user is then able to configure and control the exported storage as described below.

Symmetrix storage is configured and controlled in-band via an external server running one of the following:

- EMC Control Center enables the Symmetrix storage to be managed or monitored.
- Volume Logix is a volume configuration management tool. It provides control over access rights to the storage when multiple hosts share target ports.

Symmetrix Command Line Interface (SYMCLI) enables the server to monitor and control Symmetrix.

### Related reference

“Configuring the EMC Symmetrix subsystem” on page 285

This part provides information about configuring the EMC Symmetrix, for attachment to a SAN Volume Controller.

## Configuring settings for the EMC Symmetrix

A number of settings and options are available through the EMC Symmetrix configuration interface.

These options and settings can have a scope of a:

- Subsystem
- Port
- Logical unit

### Related concepts

“Storage subsystems” on page 20

A storage subsystem is a device that coordinates and controls the operation of one or more disk drives and synchronizes the operation of the drives with the operation of the system as a whole.

### Related tasks

“Configuring a balanced storage subsystem” on page 260

The attachment of a storage subsystem to a SAN Volume Controller requires that some specific settings be applied to the device, some limitations are also listed for each storage type.

### Related reference

“Configuring the EMC Symmetrix subsystem” on page 285

This part provides information about configuring the EMC Symmetrix, for attachment to a SAN Volume Controller.

“Global settings for the EMC Symmetrix” on page 291

Global settings apply across an EMC Symmetrix subsystem.

“Port settings for the EMC Symmetrix” on page 291

Target port characteristics can be set using the **set port** command.

“LU settings for the EMC Symmetrix” on page 292

LU settings are configurable at the LU level.



“Mapping and virtualization settings for the EMC Symmetrix” on page 293  
 LUs can be mapped to a particular director or target port using the **map dev** command from the Symmetrix Command Line Interface (SYMCLI).

**Related information**

“Servicing storage subsystems” on page 273  
 When servicing your storage subsystems, it is imperative that you follow the service instructions contained in the vendor documentation.

**Global settings for the EMC Symmetrix**

Global settings apply across an EMC Symmetrix subsystem.

Subsystem characteristics can be set using the **set Symmetrix** command. The characteristics can be viewed using the **symconfigure** command from the Symmetrix Command Line Interface (SYMCLI).

*Table 26. EMC Symmetrix global settings supported by the SAN Volume Controller*

Option	EMC Symmetrix Default Setting	SAN Volume Controller Required Setting
max_hypers_per_disk		any
dynamic_rdf	disable	disable
fba_multi_access_cache	disable	n/a
Raid_s_support	disable	enable, disable

**Related concepts**

“Storage subsystems” on page 20  
 A storage subsystem is a device that coordinates and controls the operation of one or more disk drives and synchronizes the operation of the drives with the operation of the system as a whole.

**Related tasks**

“Configuring a balanced storage subsystem” on page 260  
 The attachment of a storage subsystem to a SAN Volume Controller requires that some specific settings be applied to the device, some limitations are also listed for each storage type.

**Port settings for the EMC Symmetrix**

Target port characteristics can be set using the **set port** command.

The characteristics can be viewed using the **symcfg** command from the Symmetrix Command Line Interface (SYMCLI).

*Table 27. EMC Symmetrix port settings supported by the SAN Volume Controller*

Option	EMC Symmetrix Default Setting	SAN Volume Controller Required Setting
Disk_Array	enabled	disabled
Volume_Set_Addresssing	enabled	disabled
Hard_Addresssing	enabled	enabled
Non_Participating	disabled	disabled
Global_3rdParty_Logout	enabled	enabled
Tagged_Commands	enabled	enabled
Common_Serial_Number		enabled
Disable_Q_Reset_on_UA	disabled	disabled

Table 27. EMC Symmetrix port settings supported by the SAN Volume Controller (continued)

Option	EMC Symmetrix Default Setting	SAN Volume Controller Required Setting
Return_busy_for_abort	disabled	disabled
SCSI-3	disabled	disabled
Environ_Set	disabled	disabled
Unique_WWN	enabled	enabled
Point_to_Point	disabled	enabled
VCM_State	disabled	either
OpenVMS	disabled	disabled

### Related concepts

“Storage subsystems” on page 20

A storage subsystem is a device that coordinates and controls the operation of one or more disk drives and synchronizes the operation of the drives with the operation of the system as a whole.

“Virtual disk-to-host mapping” on page 30

Virtual disk-to-host mapping is the process of controlling which hosts have access to specific virtual disks (VDisks) within the SAN Volume Controller.

### Related tasks

“Configuring a balanced storage subsystem” on page 260

The attachment of a storage subsystem to a SAN Volume Controller requires that some specific settings be applied to the device, some limitations are also listed for each storage type.

## LU settings for the EMC Symmetrix

LU settings are configurable at the LU level.

This topic lists the LU settings, the EMC Symmetrix defaults settings and the settings that are required for the SAN Volume Controller. LU characteristics can be set using the **set device** command from the Symmetrix Command Line Interface (SYMCLI).

Table 28. EMC Symmetrix LU settings supported by the SAN Volume Controller

Option	EMC Symmetrix Default Setting	SAN Volume Controller Required Setting
emulation		FBA
attribute		RAD

### Related concepts

“Storage subsystems” on page 20

A storage subsystem is a device that coordinates and controls the operation of one or more disk drives and synchronizes the operation of the drives with the operation of the system as a whole.

### Related tasks

“Configuring a balanced storage subsystem” on page 260

The attachment of a storage subsystem to a SAN Volume Controller requires that some specific settings be applied to the device, some limitations are also listed for each storage type.

## Mapping and virtualization settings for the EMC Symmetrix

LUs can be mapped to a particular director or target port using the **map dev** command from the Symmetrix Command Line Interface (SYMCLI).

They can be unmapped using the **unmap dev** command. Mapping a logical unit to a host is a function of the EMC Control Center.

### Related reference

“Switch zoning for the SAN Volume Controller” on page 351  
Consider these constraints when zoning a switch.

---

## Configuring the Enterprise Storage Server

This part provides information about configuring the Enterprise Storage Server (ESS) so it can attach to a SAN Volume Controller.

### Related tasks

“Configuring the Enterprise Storage Server (ESS)”

To configure the Enterprise Storage Server (ESS), perform these steps.

### Related reference

“Supported models of the ESS” on page 295

The following table lists the supported models of the ESS.

“Supported firmware levels for the ESS” on page 295

See the following Web site for specific firmware levels and the latest supported hardware. <http://www-1.ibm.com/servers/storage/support/virtual/2145.html>

“Concurrent maintenance on the ESS” on page 295

Concurrent maintenance is the capability to perform I/O operations to an ESS while simultaneously performing maintenance operations on it.

“User interface on ESS” on page 295

Ensure that you are familiar with the user interface which supports the ESS subsystem.

“Sharing the ESS between a host and the SAN Volume Controller” on page 296

The ESS can be shared between a host and a SAN Volume Controller.

“Switch zoning limitations for the ESS” on page 296

Consider the following limitations when planning switch zoning and connection to the SAN.

“Quorum disks on the ESS” on page 296

Managed disks presented by the ESS will be chosen by the SAN Volume Controller as quorum disks.

“Advanced functions for the ESS” on page 297

ESS provides advanced functions that are not compatible with the SAN Volume Controller.

“Logical unit creation and deletion on the ESS” on page 297

Before creating or deleting a logical unit on the ESS, consider these constraints.

## Configuring the Enterprise Storage Server (ESS)

To configure the Enterprise Storage Server (ESS), perform these steps.

1. Use a Web browser to access the ESS Specialist by entering the IP address of the ESS.
2. Login using the user name and password.
3. Click **ESS Specialist**.
4. Click **Storage Allocation**.

5. Click **Open System Storage**.
6. Click **Modify Host Systems**.
7. Create a host entry for every initiator port on every SAN Volume Controller node in your cluster. Complete the following fields:

**Nickname**

Type a unique name for each port (for example, knode or 1node).

**Host Type**

Select **IBM SAN Volume Controller** or **RS/6000** if that is not available.

**Host Attachment**

Select **Fibre Channel attached**.

**Hostname/IP address**

Leave this field blank.

**WWPN**

Either select the WWPN from the list, or type it manually. A configuration command will fail if you use WWPN 0 in the command string.

8. After you are finished adding all of the ports, click **Perform Configuration Update**.
9. Click **Add Volumes** to add the volumes on which you want the SAN Volume Controller to run.
10. From the Add Volumes window, perform the following actions:
  - a. Select any of the SAN Volume Controller host ports that you created earlier.
  - b. Select the necessary ESS adapter to create the volumes.
  - c. Click **Next**.
  - d. Create volumes using your desired size, placement, and RAID level.
  - e. After you are done creating all the volumes, click **Perform Configuration Update**.
11. Map the volumes to all of your SAN Volume Controller ports by performing the following steps:
  - a. Click **Modify Volume Assignments**.
  - b. Select all of the volumes that you created earlier.
  - c. Click **Assigning selected volumes to target hosts**.
  - d. Select all of the remaining SAN Volume Controller host ports that you created earlier.
  - e. Select the **Use same ID/LUN in source and target** check box.
  - f. Click **Perform Configuration Update**.

**Related tasks**

“Configuring a balanced storage subsystem” on page 260

The attachment of a storage subsystem to a SAN Volume Controller requires that some specific settings be applied to the device, some limitations are also listed for each storage type.

“Expanding a logical unit” on page 263

A logical unit can be expanded using vendor-specific disk-configuration software.

**Related reference**

“Configuring and servicing storage subsystems” on page 253  
Follow the guidelines and procedures outlined in this section to make the most of the performance available from your storage subsystems and to avoid potential I/O problems.

**Related information**

“Configuring the Enterprise Storage Server” on page 293  
This part provides information about configuring the Enterprise Storage Server (ESS) so it can attach to a SAN Volume Controller.

## Supported models of the ESS

The following table lists the supported models of the ESS.

*Table 29. Supported models of the Enterprise Storage Server*

Model
2105-F20
2105-800

**Related information**

“Configuring the Enterprise Storage Server” on page 293  
This part provides information about configuring the Enterprise Storage Server (ESS) so it can attach to a SAN Volume Controller.

## Supported firmware levels for the ESS

See the following Web site for specific firmware levels and the latest supported hardware. <http://www-1.ibm.com/servers/storage/support/virtual/2145.html>

**Related information**

“Configuring the Enterprise Storage Server” on page 293  
This part provides information about configuring the Enterprise Storage Server (ESS) so it can attach to a SAN Volume Controller.

## Concurrent maintenance on the ESS

Concurrent maintenance is the capability to perform I/O operations to an ESS while simultaneously performing maintenance operations on it.

IBM supports all ESS concurrent maintenance procedures.

**Related information**

“Configuring the Enterprise Storage Server” on page 293  
This part provides information about configuring the Enterprise Storage Server (ESS) so it can attach to a SAN Volume Controller.

## User interface on ESS

Ensure that you are familiar with the user interface which supports the ESS subsystem.

### Web Server

A Web server is running on each of the controllers on the subsystem. During normal operation, the user interface only allows basic monitoring of the subsystem and displays an error log. If a controller is put into diagnostic mode by pressing the reset button on the controller, the user interface allows for firmware upgrades and subsystem configuration resets.

### **Related information**

“Configuring the Enterprise Storage Server” on page 293  
This part provides information about configuring the Enterprise Storage Server (ESS) so it can attach to a SAN Volume Controller.

## **Sharing the ESS between a host and the SAN Volume Controller**

The ESS can be shared between a host and a SAN Volume Controller.

IBM supports sharing an ESS between a SAN Volume Controller and other hosts. However, if an ESS port is in the same zone as a SAN Volume Controller port, that same ESS port should not be in the same zone as another host.

A single host can have both ESS direct-attached and SAN Volume Controller virtualized disks configured to it. If a LUN is managed by the SAN Volume Controller, it should never be mapped to another host.

See the following Web site for the latest supported configurations:  
<http://www-1.ibm.com/servers/storage/support/virtual/2145.html>

### **Related concepts**

“Storage subsystems” on page 51  
Follow these rules when planning the configuration of storage subsystems in the SAN fabric.

### **Related information**

“Configuring the Enterprise Storage Server” on page 293  
This part provides information about configuring the Enterprise Storage Server (ESS) so it can attach to a SAN Volume Controller.

## **Switch zoning limitations for the ESS**

Consider the following limitations when planning switch zoning and connection to the SAN.

The minimum number of cables recommended for redundancy is 2 cables from 2 separate adapter bays. Up to 16 cables can be used to connect to an ESS. Only 1 or 2 Gb fibre-channel attached is supported.

**Note:** ESCON, FICON, and Ultra SCSI attachment is not supported with the SAN Volume Controller.

### **Related reference**

“Switch zoning for the SAN Volume Controller” on page 351  
Consider these constraints when zoning a switch.

### **Related information**

“Configuring the Enterprise Storage Server” on page 293  
This part provides information about configuring the Enterprise Storage Server (ESS) so it can attach to a SAN Volume Controller.

## **Quorum disks on the ESS**

Managed disks presented by the ESS will be chosen by the SAN Volume Controller as quorum disks.

### **Related reference**

“Configuring and servicing storage subsystems” on page 253  
Follow the guidelines and procedures outlined in this section to make the most of the performance available from your storage subsystems and to avoid potential I/O problems.

#### **Related information**

“Configuring the Enterprise Storage Server” on page 293

This part provides information about configuring the Enterprise Storage Server (ESS) so it can attach to a SAN Volume Controller.

“Creating a quorum disk” on page 272

A quorum disk is used to resolve tie-break situations when the “voting set” of nodes disagree on the current cluster state.

## **Advanced functions for the ESS**

ESS provides advanced functions that are not compatible with the SAN Volume Controller.

Only open system storage is supported by the SAN Volume Controller.

### **FlashCopy and Concurrent copy**

FlashCopy and Concurrent copy are not supported on any LUN that is managed by the SAN Volume Controller.

### **Remote Copy or extended distance Remote Copy**

Remote Copy or extended distance Remote Copy are not supported on any LUN that is managed by the SAN Volume Controller.

#### **Related information**

“Configuring the Enterprise Storage Server” on page 293

This part provides information about configuring the Enterprise Storage Server (ESS) so it can attach to a SAN Volume Controller.

## **Logical unit creation and deletion on the ESS**

Before creating or deleting a logical unit on the ESS, consider these constraints.

Certain ESS types are supported for use with the SAN Volume Controller.

Before deleting or un-mapping a LUN from the SAN Volume Controller, it must first be removed from the MDisk group it was apart of. The following is supported:

- The supported LUN size is 1GB - 2TB.
- RAID 5 and RAID 10 LUNs are supported.
- LUNs can be added dynamically. When adding a new LUN, the “Use same ID/LUN in source and target” check-box **MUST** be checked.

**Note:** Failure to do this could cause loss in redundancy, or data integrity issues. The detect MDisks action in the SAN Volume Controller Console or the **lsinfo detectmdisks** command must be run in order for the SAN Volume Controller to detect the new disks.

#### **Related concepts**

“Storage subsystems” on page 20

A storage subsystem is a device that coordinates and controls the operation of one or more disk drives and synchronizes the operation of the drives with the operation of the system as a whole.

**Related tasks**

“Configuring a balanced storage subsystem” on page 260

The attachment of a storage subsystem to a SAN Volume Controller requires that some specific settings be applied to the device, some limitations are also listed for each storage type.

**Related information**

“Configuring the Enterprise Storage Server” on page 293

This part provides information about configuring the Enterprise Storage Server (ESS) so it can attach to a SAN Volume Controller.

---

## Configuring the FAStT subsystem

This part provides information about configuring the FAStT subsystem so it can attach to a SAN Volume Controller.

**Related tasks**

“Configuring FAStT disk controllers for the storage server” on page 299

FAStT disk controllers provide functionality that is compatible with the SAN Volume Controller.

“Support actions for the FAStT controller” on page 300

The FAStT disk controllers provide functionality that can be used with the SAN Volume Controller.

**Related reference**

“Supported models of the IBM FAStT controller” on page 302

The following table lists the supported models of the IBM FAStT controller that are supported by the SAN Volume Controller.

“Supported firmware levels for the FAStT” on page 302

See the following Web site for specific firmware levels and the latest supported hardware. It includes the maximum number of LUNs per partition, depending on the firmware level. [http://www-](http://www-1.ibm.com/servers/storage/support/virtual/2145.html)

[1.ibm.com/servers/storage/support/virtual/2145.html](http://www-1.ibm.com/servers/storage/support/virtual/2145.html)

“Concurrent maintenance on the IBM FAStT” on page 302

Concurrent maintenance is the capability to perform I/O operations to an IBM FAStT controller while simultaneously performing maintenance operations on it. Refer to your FAStT documentation for information about concurrent maintenance.

“User interface on FAStT” on page 302

Ensure that you are familiar with the user interface which supports the FAStT subsystem.

“Sharing the IBM FAStT controller between a host and the SAN Volume Controller” on page 303

The IBM FAStT controller can be shared between a host and a SAN Volume Controller.

“Quorum disks on the IBM FAStT” on page 303

Managed disks presented by the IBM FAStT controller will be chosen by the SAN Volume Controller as quorum disks.

“Advanced functions for the IBM FAStT” on page 303

FlashCopy and Remote Copy facilities are provided as advanced functions on



the IBM FAStT controller, however these controller-delivered copy services are not supported by SAN Volume Controller.

“Logical unit creation and deletion on the IBM FAStT” on page 305

To create or delete logical units on the IBM FAStT, complete the following tasks.

“Configuration interface for the IBM FAStT” on page 305

The IBM FAStT provides a configuration application.

“Controller settings for the IBM FAStT” on page 306

Controller settings are settings that apply across one FAStT controller.

## Configuring FAStT disk controllers for the storage server

FAStT disk controllers provide functionality that is compatible with the SAN Volume Controller.

**Attention:** The SAN Volume Controller does not concurrently support I/O operations with the download of ESM (Environmental Services Monitor) firmware. You must quiesce all I/O operations from the hosts that are using storage provided by the FAStT controllers you wish to update before installing new ESM firmware.

The FAStT storage server has many options and actions. The following list provides the supported actions and its impact on the SAN Volume Controller and its configuration.

### 1. host type:

- a. You must set either the default host type of your FAStT or the host type of the chosen partition to:

IBM TS SAN VCE

- 1) Click **Storage Subsystem** → **Change** → **Default Host Type**, or
- 2) For each host port you can specify the host type of that port or modify existing ports.

### 2. WWNN:

- a. Set the subsystem so that both controllers have the same WWNN. Scripts are available from the FAStT support Web site to change the set up of the FAStT if required.

[www.storage.ibm.com](http://www.storage.ibm.com)

### 3. auto volume transfer (AVT):

- a. Make sure the auto volume transfer is enabled. The host type selection should have enabled this function already.
- b. View the storage subsystem profile data to confirm that you have the AVT function enabled. This storage profile is presented as a text view in a separate window.
- c. Scripts are available from the FAStT Web site to enable AVT if required.

[www.storage.ibm.com](http://www.storage.ibm.com)

### 4. limitations:

- a. Only one FAStT storage partition can be created that contains any of the ports of any of the nodes in a single SAN Volume Controller cluster.
- b. You must not map more than one partition to any of the ports on any of the nodes in the same SAN Volume Controller cluster. Otherwise, unexpected

behavior might result. For example, there will not be any warning messages, however, there will be errors logged in the SAN Volume Controller error log and access to storage may be lost.

5. access LUN:
  - a. The access LUN, also known as the Universal Transport Mechanism (UTM) LUN, might not be in a partition that contains the SAN Volume Controller ports. It is not required by the SAN Volume Controller. The UTM LUN is a special LUN that allows the SAN Volume Controller to be configured through suitable software over the Fibre channel connection. However, the SAN Volume Controller does not require the UTM LUN, therefore does not generate errors either way.
  - b. The FASTT *must not* have the Access (UTM) LUN presented as Logical Unit Number 0 (zero).
6. logical unit:
  - a. The SAN Volume Controller attempts to follow the FASTT specified preferred ownership. You can specify which controller (A or B) is used to do I/O operations to a given Logical Unit. If the SAN Volume Controller can see the ports of the preferred controller and no error conditions exist, then it will access that Logical Unit through one of the ports on that controller.
  - b. Under error conditions, the ownership is ignored. Meaning, the SAN Volume Controller has found a given path through the fabric to be errant, or there is no connection to a given port.
7. Copy services (FlashCopy and Remote Copy):
  - a. FASTT copy services *must not* be used when the SAN Volume Controller is attached to the FASTT. Partitioning might allow copy services to be used on other host platforms.

#### **Related tasks**

“Configuring a balanced storage subsystem” on page 260

The attachment of a storage subsystem to a SAN Volume Controller requires that some specific settings be applied to the device, some limitations are also listed for each storage type.

“Configuring the Enterprise Storage Server (ESS)” on page 293

To configure the Enterprise Storage Server (ESS), perform these steps.

“Expanding a logical unit” on page 263

A logical unit can be expanded using vendor-specific disk-configuration software.

#### **Related reference**

“Configuring and servicing storage subsystems” on page 253

Follow the guidelines and procedures outlined in this section to make the most of the performance available from your storage subsystems and to avoid potential I/O problems.

#### **Related information**

“Configuring the FASTT subsystem” on page 298

This part provides information about configuring the FASTT subsystem so it can attach to a SAN Volume Controller.

## **Support actions for the FASTT controller**

The FASTT disk controllers provide functionality that can be used with the SAN Volume Controller.

The FAStT storage manager has many options and actions. The following shows the supported actions and their impact on the SAN Volume Controller and its configuration.

1. controller run diagnostics:
  - a. The diagnostics should be automatically recovered by the SAN Volume Controller software.
  - b. Check your MDisks to make sure that they have not been set to degraded mode after this action.
2. controller disable data transfer:
  - a. This option is not supported when a SAN Volume Controller is attached to the FAStT. Loss of availability and redundancy may occur if data transfer is disabled.
3. setting an array Offline:
  - a. Do not set an array Offline. If you use this setting, you might lose access to the MDisk group.
4. array increase capacity:
  - a. Increasing capacity is supported but the new capacity is not usable until the MDisk is removed from an MDisk group and then added again. You might have to migrate data to increase the capacity.
5. redistribute logical drives or change ownership of the preferred path:
  - a. These actions are supported but might not take effect until a cluster rediscovery is initiated on the SAN Volume Controller cluster. This can be achieved using the **svctask detectmdisk** command.
6. controller reset
  - a. Controller reset should only be performed if directed to do so by service personnel, the alternate controller is functional and available to the SAN. The SAN Volume Controller reset should be automatically recovered by the SAN Volume Controller software.
  - b. Check your MDisks to make sure that they have not been set to degraded state during this operation. You can issue the **svctask includemdisk** to repair degraded MDisks.

#### **Related tasks**

“Configuring a balanced storage subsystem” on page 260

The attachment of a storage subsystem to a SAN Volume Controller requires that some specific settings be applied to the device, some limitations are also listed for each storage type.

“Configuring the Enterprise Storage Server (ESS)” on page 293

To configure the Enterprise Storage Server (ESS), perform these steps.

#### **Related reference**

“Configuring and servicing storage subsystems” on page 253

Follow the guidelines and procedures outlined in this section to make the most of the performance available from your storage subsystems and to avoid potential I/O problems.

#### **Related information**

“Configuring the FAStT subsystem” on page 298

This part provides information about configuring the FAStT subsystem so it can attach to a SAN Volume Controller.

## Supported models of the IBM FAStT controller

The following table lists the supported models of the IBM FAStT controller that are supported by the SAN Volume Controller.

Table 30. Supported models of the IBM FAStT controller

Model
1724 FAStT model 100
3542 FAStT model 200
3552 FAStT model 500
1722 FAStT model 600
1742/1RU FAStT model 700
1742/90U FAStT model 900

**Note:** Some levels of FAStT microcode support a maximum of 32 LUNs per host partition, newer versions allow up to 256 LUNs per host partition.

### Related information

“Configuring the FAStT subsystem” on page 298

This part provides information about configuring the FAStT subsystem so it can attach to a SAN Volume Controller.

## Supported firmware levels for the FAStT

See the following Web site for specific firmware levels and the latest supported hardware. It includes the maximum number of LUNs per partition, depending on the firmware level. <http://www-1.ibm.com/servers/storage/support/virtual/2145.html>

### Related information

“Configuring the FAStT subsystem” on page 298

This part provides information about configuring the FAStT subsystem so it can attach to a SAN Volume Controller.

## Concurrent maintenance on the IBM FAStT

Concurrent maintenance is the capability to perform I/O operations to an IBM FAStT controller while simultaneously performing maintenance operations on it. Refer to your FAStT documentation for information about concurrent maintenance.

### Related information

“Configuring the FAStT subsystem” on page 298

This part provides information about configuring the FAStT subsystem so it can attach to a SAN Volume Controller.

## User interface on FAStT

Ensure that you are familiar with the user interface which supports the FAStT subsystem.

### Web Server

A Web server is running on each of the controllers on the subsystem. During normal operation, the user interface only allows basic monitoring of the subsystem and displays an error log. If a controller is put into diagnostic mode by pressing the reset button on the controller, the user interface allows for firmware upgrades and subsystem configuration resets.

### **Related information**

“Configuring the FASTt subsystem” on page 298

This part provides information about configuring the FASTt subsystem so it can attach to a SAN Volume Controller.

## **Sharing the IBM FASTt controller between a host and the SAN Volume Controller**

The IBM FASTt controller can be shared between a host and a SAN Volume Controller.

**Attention:** The use of the FASTt term “partitioning” does not hold the same meaning as used by IBM.

The FASTt function known as partitioning must be used to separate groups of logical units that are directly attached to hosts or groups of hosts from the SAN Volume Controller accessed logical units.

**Note:** The SAN Volume Controller partition must either contain all the ports of the SAN Volume Controller cluster that are connected to the SAN, or are zoned to have access to the FASTt ports. At least one port from each FASTt controller must be visible by the SAN Volume Controller cluster.

### **Related concepts**

“Storage subsystems” on page 51

Follow these rules when planning the configuration of storage subsystems in the SAN fabric.

### **Related information**

“Configuring the FASTt subsystem” on page 298

This part provides information about configuring the FASTt subsystem so it can attach to a SAN Volume Controller.

## **Quorum disks on the IBM FASTt**

Managed disks presented by the IBM FASTt controller will be chosen by the SAN Volume Controller as quorum disks.

**Note:** The FASTt 200 does not support quorum disks.

### **Related reference**

“Configuring and servicing storage subsystems” on page 253

Follow the guidelines and procedures outlined in this section to make the most of the performance available from your storage subsystems and to avoid potential I/O problems.

### **Related information**

“Configuring the FASTt subsystem” on page 298

This part provides information about configuring the FASTt subsystem so it can attach to a SAN Volume Controller.

“Creating a quorum disk” on page 272

A quorum disk is used to resolve tie-break situations when the “voting set” of nodes disagree on the current cluster state.

## **Advanced functions for the IBM FASTt**

FlashCopy and Remote Copy facilities are provided as advanced functions on the IBM FASTt controller, however these controller-delivered copy services are not supported by SAN Volume Controller.

### **Related concepts**

“Remote Copy” on page 44

Remote Copy enables you to set up a relationship between two virtual disks, so that updates that are made by an application to one virtual disk are mirrored on the other virtual disk.

### **Related reference**

“Data migration on an existing FASTT installation that contains partitions”

You can migrate data on an existing FASTT installation that contains partitions.

### **Related information**

“Configuring the FASTT subsystem” on page 298

This part provides information about configuring the FASTT subsystem so it can attach to a SAN Volume Controller.

## **Data migration on an existing FASTT installation that contains partitions**

You can migrate data on an existing FASTT installation that contains partitions.

You can enable the SAN Volume Controller to be introduced to an existing SAN environment, so that you have the option of utilizing image mode LUNs to import the existing data into the virtualization environment without requiring a backup and restore cycle. For example, each FASTT partition may contain up to 32 LUNs. Each partition can only access a unique set of HBA ports (as defined by WWPNs). That is, for a single host to access multiple partitions, unique host fibre ports (WWPNs) need to be assigned to each partition. All LUNs within a partition are surfaced to assigned host fibre ports (no sub-partition LUN mapping).

Host A is mapped to LUN 0, 1, 2 in Partition 0

Host B is mapped to LUN 0, 1, 2, 3, 4, 5 in Partition 1

Host C is mapped to LUN 0, 1, 2 in Partition 2

To allow Host A to access the LUNs in partition B, it is necessary to remove one of the HBAs (for example, A1) from the access list for partition 0 and add it to partition 1 (A1 cannot be on the access list for more than one partition).

To add a SAN Volume Controller into this configuration without save and restore cycles would require that a set of unique SAN Volume Controller HBA port WWPNs for each partition. This would allow the FASTT to surface the LUNs (with your data) to the SAN Volume Controller, which would then configure these LUNs as image-mode LUNs and surface them to the required hosts. Unfortunately, this violates a requirement that all SAN Volume Controller nodes be able to see all backend storage. To work around this problem, change the FASTT to allow more than 32 LUNs in 1 storage partition, so that you can move all the LUNs from all the other partitions into 1 partition and map to the SAN Volume Controller cluster.

For example, lets say the FASTT has 8 partitions with 30 LUNs in each. Perform the following:

1. Change the mappings for the first 4 partitions on the FASTT such that each partition is mapped to 1 port on each node, this maintains redundancy across the cluster.
2. Create a new partition on the FASTT that is mapped to all 4 ports on all the SAN Volume Controllers (actually not a partition at all)
3. Gradually migrate the data into the MDisks in the target partition, as storage is freed from the source partitions this can be reused as new storage in the target

partition. As partitions are deleted new partitions that need to be migrated can be mapped and migrated in the same way. The host side data access and integrity would be maintained throughout this process.

## Logical unit creation and deletion on the IBM FAStT

To create or delete logical units on the IBM FAStT, complete the following tasks.

Certain IBM FAStT controller types are supported for use with the SAN Volume Controller.

To create a logical disk, you must set either the default host type of your FAStT or the host type of the chosen partition to:

IBM TS SAN VCE

You can set the host type in 2 ways:

1. Click **Storage Subsystem** → **Change** → **Default Host Type**, or
2. For each host port you can specify the host type of that port or modify existing ports.

### Related concepts

“Storage subsystems” on page 20

A storage subsystem is a device that coordinates and controls the operation of one or more disk drives and synchronizes the operation of the drives with the operation of the system as a whole.

### Related tasks

“Configuring a balanced storage subsystem” on page 260

The attachment of a storage subsystem to a SAN Volume Controller requires that some specific settings be applied to the device, some limitations are also listed for each storage type.

### Related information

“Configuring the FAStT subsystem” on page 298

This part provides information about configuring the FAStT subsystem so it can attach to a SAN Volume Controller.

## Configuration interface for the IBM FAStT

The IBM FAStT provides a configuration application.

The access LUN, also known as the Universal Transport Mechanism (UTM) LUN, is the configuration interface for the IBM FAStT controller.

The access LUN might not be in a partition that contains the SAN Volume Controller ports. It is not required by the SAN Volume Controller. The UTM LUN is a special LUN that allows the SAN Volume Controller to be configured through suitable software over the Fibre channel connection. However, the SAN Volume Controller does not require the UTM LUN, therefore does not generate errors either way. The FAStT *must not* have the Access (UTM) LUN presented as Logical Unit Number 0 (zero).

It is possible to use in-band (over fibre-channel) and out-of-band (Ethernet) to allow the FAStT configuration software to communicate with more than one FAStT. If using in-band configuration, the “Access” logical unit will need to be configured in a partition that does not include any logical units being accessed by the SAN Volume Controller cluster.

**Note:** In-band is not supported via access to the LUN while in the SAN Volume Controller partition.

#### **Related information**

“Configuring the FAStT subsystem” on page 298

This part provides information about configuring the FAStT subsystem so it can attach to a SAN Volume Controller.

## **Controller settings for the IBM FAStT**

Controller settings are settings that apply across one FAStT controller.

For restrictions on controller settings, see the following:

- You must set either the default host type of your FAStT or the host type of the chosen partition to:

IBM TS SAN VCE

You can set the host type in 2 ways:

1. Click **Storage Subsystem** → **Change** → **Default Host Type**, or
  2. For each host port you can specify the host type of that port or modify existing ports.
- Set the subsystem so that both controllers have the same WWNN. Scripts are available from the FAStT support Web site to change the set up of the FAStT if required.

[www.storage.ibm.com](http://www.storage.ibm.com)

- Make sure the auto volume transfer is enabled. The host type selection should have enabled this function already. View the storage subsystem profile data to confirm that you have the AVT function enabled. This storage profile is presented as a text view in a separate window. Scripts are available from the FAStT Web site to enable AVT if required.

[www.storage.ibm.com](http://www.storage.ibm.com)

- Ensure that you have the following enabled on any logical units mapped to the :
  - read caching
  - write caching
  - write cache mirroring

Caching without batteries must not be enabled.

#### **Related concepts**

“Storage subsystems” on page 20

A storage subsystem is a device that coordinates and controls the operation of one or more disk drives and synchronizes the operation of the drives with the operation of the system as a whole.

#### **Related tasks**

“Configuring a balanced storage subsystem” on page 260

The attachment of a storage subsystem to a SAN Volume Controller requires that some specific settings be applied to the device, some limitations are also listed for each storage type.

#### **Related reference**

“Configuring settings for the IBM FAStT” on page 307

This topic provides information about configuring settings for the IBM FAStT.



“Global settings for the IBM FAStT” on page 308  
Global settings apply across an IBM FAStT controller.

“LU settings for the IBM FAStT” on page 308  
LU settings are configurable at the LU level.

“Miscellaneous settings for the IBM FAStT” on page 309  
There are options of a miscellaneous nature that must be set properly in order for the IBM FAStT controller to work with the SAN Volume Controller. Refer to your FAStT documentation for information about other settings.

“Mapping and virtualization settings for IBM FAStT” on page 309  
Review the following information to understand LUN mapping (or masking) and virtualization from the point of view of the IBM FAStT controller and their use in a SAN Volume Controller environment.

#### **Related information**

“Configuring the FAStT subsystem” on page 298  
This part provides information about configuring the FAStT subsystem so it can attach to a SAN Volume Controller.

### **Configuring settings for the IBM FAStT**

This topic provides information about configuring settings for the IBM FAStT.

The IBM FAStT controller configuration interface provides configuration settings and options. This topic and its subtopics discusses those options and settings that are supported with the SAN Volume Controller.

These options and settings can have a scope of a:

- Subsystem
- Logical unit, see the following:
  - The SAN Volume Controller attempts to follow the FAStT specified preferred ownership. You can specify which controller (A or B) is used to do I/O operations to a given Logical Unit. If the SAN Volume Controller can see the ports of the preferred controller and no error conditions exist, then it will access that Logical Unit through one of the ports on that controller. Under error conditions, the ownership is ignored. Meaning, the SAN Volume Controller has found a given path through the fabric to be errant, or there is no connection to a given port.
  - Ensure that you have the following enabled on any logical units mapped to the SAN Volume Controller:
    - read caching
    - write caching
    - write cache mirroring

Caching without batteries must not be enabled.

#### **Related concepts**

“Storage subsystems” on page 20  
A storage subsystem is a device that coordinates and controls the operation of one or more disk drives and synchronizes the operation of the drives with the operation of the system as a whole.

#### **Related tasks**

“Configuring a balanced storage subsystem” on page 260  
The attachment of a storage subsystem to a SAN Volume Controller requires that some specific settings be applied to the device, some limitations are also listed for each storage type.

“Configuring FAStT disk controllers for the storage server” on page 299  
FAStT disk controllers provide functionality that is compatible with the SAN Volume Controller.

**Related information**

“Servicing storage subsystems” on page 273  
When servicing your storage subsystems, it is imperative that you follow the service instructions contained in the vendor documentation.

**Global settings for the IBM FAStT**

Global settings apply across an IBM FAStT controller.

*Table 31. IBM FAStT controller global settings supported by the SAN Volume Controller*

Option	FAStT Default Setting
Start flushing	80%
Stop flushing	80%
Cache block size	4 Kb

These settings can be adjusted depending on the performance requirements. Modification of these settings is not recommended unless directed to do so by support personnel.

If partitioning is not being used, meaning all the FAStT logical units are visible to the SAN Volume Controller, then the default host type for the FAStT subsystem can be set. See step 1 on page 299. If partitioning is being used to group SAN Volume Controller ports and host ports apart then the host type for each partition, or group of SAN Volume Controller ports, must be defined. When defining host ports, the host type must be set to:IBM TS SAN VCE

**Related concepts**

“Storage subsystems” on page 20  
A storage subsystem is a device that coordinates and controls the operation of one or more disk drives and synchronizes the operation of the drives with the operation of the system as a whole.

**Related tasks**

“Configuring a balanced storage subsystem” on page 260  
The attachment of a storage subsystem to a SAN Volume Controller requires that some specific settings be applied to the device, some limitations are also listed for each storage type.

**LU settings for the IBM FAStT**

LU settings are configurable at the LU level.

LUs that are accessed by hosts can be configured differently. This topic lists those settings, what the IBM FAStT controller defaults are, and what the required settings are for the SAN Volume Controller.

Read ahead cache multiplier is typically set to 0 or 1. Modification of these settings is not recommended unless directed to do so by support personnel.

Ensure that you have the following enabled on any logical units mapped to the SAN Volume Controller:

- read caching
- write caching

- write cache mirroring

Caching without batteries must not be enabled.

When creating a new logical unit set the host type for that logical unit to the host type IBM TS SAN VCE.

**Note:** IBM TS SAN VCE is set as the default if the default type was already displayed.

**Related concepts**

“Storage subsystems” on page 20

A storage subsystem is a device that coordinates and controls the operation of one or more disk drives and synchronizes the operation of the drives with the operation of the system as a whole.

**Related tasks**

“Configuring a balanced storage subsystem” on page 260

The attachment of a storage subsystem to a SAN Volume Controller requires that some specific settings be applied to the device, some limitations are also listed for each storage type.

### **Miscellaneous settings for the IBM FASTT**

There are options of a miscellaneous nature that must be set properly in order for the IBM FASTT controller to work with the SAN Volume Controller. Refer to your FASTT documentation for information about other settings.

**Related concepts**

“Storage subsystems” on page 20

A storage subsystem is a device that coordinates and controls the operation of one or more disk drives and synchronizes the operation of the drives with the operation of the system as a whole.

**Related tasks**

“Configuring a balanced storage subsystem” on page 260

The attachment of a storage subsystem to a SAN Volume Controller requires that some specific settings be applied to the device, some limitations are also listed for each storage type.

### **Mapping and virtualization settings for IBM FASTT**

Review the following information to understand LUN mapping (or masking) and virtualization from the point of view of the IBM FASTT controller and their use in a SAN Volume Controller environment.

**Related reference**

“Switch zoning for the SAN Volume Controller” on page 351

Consider these constraints when zoning a switch.

---

## **Configuring the HDS Lightning subsystem**

This part provides information about configuring the HDS Lightning subsystem so it can attach to a SAN Volume Controller.

**Related reference**

“Supported models of the HDS Lightning” on page 310

The following table lists the models of the HDS Lightning that are supported by the SAN Volume Controller.

“Supported firmware levels for HDS Lightning” on page 310

See the following Web site for specific HDS Lightning firmware levels and the

latest supported hardware. <http://www-1.ibm.com/servers/storage/support/virtual/2145.html>

“Concurrent maintenance on the HDS Lightning 99xxV” on page 311  
Concurrent upgrade of the HDS Lightning 99xxV firmware is supported with the SAN Volume Controller.

“User interface on Lightning” on page 311  
Ensure that you are familiar with the user interface which supports the Lightning subsystem.

“Sharing the HDS Lightning 99xxV between host and the SAN Volume Controller” on page 311

The HDS Lightning 99xxV can be shared between a host and a SAN Volume Controller according to certain restrictions.

“Quorum disks on HDS Lightning 99xxV” on page 312

HDS Lightning 99xxV is not an approved host for quorum disks. Therefore, configurations with only Lightning are not possible.

“Advanced functions for HDS Lightning” on page 312

The advanced functions of the HDS Lightning 99xxV may or may not be compatible with the SAN Volume Controller. Advanced copy functions are not supported for LUs managed by SAN Volume Controller since they do not extend to the SAN Volume Controller cache.

“LU configuration for Lightning” on page 313

Logical unit configuration for Lightning supports both RAID 1 and RAID 5 arrays.

“Configuring settings for Lightning” on page 315

The Lightning configuration interface provides functionality for configuration.

## Supported models of the HDS Lightning

The following table lists the models of the HDS Lightning that are supported by the SAN Volume Controller.

*Table 32. Supported HDS Lightning models*

Model
Lightning 9910V
Lightning 9960V
Lightning 9970V
Lightning 9980V

### Related information

“Configuring the HDS Lightning subsystem” on page 309

This part provides information about configuring the HDS Lightning subsystem so it can attach to a SAN Volume Controller.

## Supported firmware levels for HDS Lightning

See the following Web site for specific HDS Lightning firmware levels and the latest supported hardware. <http://www-1.ibm.com/servers/storage/support/virtual/2145.html>

**Note:** Concurrent upgrade of the controller firmware is **not** supported with the SAN Volume Controller.

### Related information

“Configuring the HDS Lightning subsystem” on page 309

This part provides information about configuring the HDS Lightning subsystem so it can attach to a SAN Volume Controller.

## Concurrent maintenance on the HDS Lightning 99xxV

Concurrent upgrade of the HDS Lightning 99xxV firmware is supported with the SAN Volume Controller.

### Related information

“Configuring the HDS Lightning subsystem” on page 309

This part provides information about configuring the HDS Lightning subsystem so it can attach to a SAN Volume Controller.

## User interface on Lightning

Ensure that you are familiar with the user interface which supports the Lightning subsystem.

### SVP

Lightning has a laptop in the controller frame. The laptop runs the primary configuration user interface, which is called SVP. Using SVP, it is possible to do almost every configuration task as well as monitor the controller.

### HiCommand

HiCommand is a graphical user interface that allows basic creation of storage and system monitoring. It communicates with Lightning through Ethernet.

### Related information

“Configuring the HDS Lightning subsystem” on page 309

This part provides information about configuring the HDS Lightning subsystem so it can attach to a SAN Volume Controller.

## Sharing the HDS Lightning 99xxV between host and the SAN Volume Controller

The HDS Lightning 99xxV can be shared between a host and a SAN Volume Controller according to certain restrictions.

### Sharing ports

The HDS Lightning 99xxV can be shared between a host and a SAN Volume Controller according to certain restrictions. The following restriction applies:

- The same host cannot be connected to both a SAN Volume Controller and a Lightning at the same time because HDLM and the Subsystem Device Driver do not coexist.
- A controller port cannot be shared between a host and a SAN Volume Controller. In other words, if a controller port is used by a SAN Volume Controller it must not be present in a switch zone which allows a host to access the port.
- Logical units (LUs) cannot be shared between a host and a SAN Volume Controller.

### Supported Topologies

SAN Volume Controller supports connection to the Lightning according to the following restrictions:

- The SAN Volume controller resolves up to four WWNNs per subsystem and allows up to 512 LUs per WWNN. Lightning assigns a WWNN per port, therefore the SAN Volume Controller could be a limitation to both capacity (2048 LUs) and

bandwidth (4 ports). You can use the following procedure for Lightning subsystems with 8 ports if more capacity or bandwidth is required:

1. Divide the set of ports into groups of between 2 and 4.
2. Assign a discreet set of logical units to each group.

SAN Volume Controller then interprets each group as a separate subsystem.

- If a logical unit is mapped to the SAN Volume Controller port as LUNx, it must appear as LUNx to all the SAN Volume Controller ports in the cluster and must also appear as LUNx through all of the controller ports that it is mapped to.
- Command LUNs must not be mapped to the SAN Volume Controller.
- LUN Expansion (LUSE) and Virtual LVI/LUN operations cannot be run on a disk managed by the SAN Volume Controller. LUNs created using LUSE and Virtual LVI/LUN can be mapped to the SAN Volume Controller after they have been created.
- Only disks with open emulation can be mapped to the SAN Volume Controller. S/390 disks cannot be used with the SAN Volume Controller. Only fibre channel connections can be used to connect the SAN Volume Controller to the Lightning.

#### **Related concepts**

“Storage subsystems” on page 51

Follow these rules when planning the configuration of storage subsystems in the SAN fabric.

#### **Related information**

“Configuring the HDS Lightning subsystem” on page 309

This part provides information about configuring the HDS Lightning subsystem so it can attach to a SAN Volume Controller.

## **Quorum disks on HDS Lightning 99xxV**

HDS Lightning 99xxV is not an approved host for quorum disks. Therefore, configurations with only Lightning are not possible.

#### **Related information**

“Configuring the HDS Lightning subsystem” on page 309

This part provides information about configuring the HDS Lightning subsystem so it can attach to a SAN Volume Controller.

“Creating a quorum disk” on page 272

A quorum disk is used to resolve tie-break situations when the “voting set” of nodes disagree on the current cluster state.

## **Advanced functions for HDS Lightning**

The advanced functions of the HDS Lightning 99xxV may or may not be compatible with the SAN Volume Controller. Advanced copy functions are not supported for LUs managed by SAN Volume Controller since they do not extend to the SAN Volume Controller cache.

#### **ShadowImage**

ShadowImage is functionally similar to FlashCopy. ShadowImage is not supported when the disk controller system is being used with the SAN Volume Controller. Even when a Lightning 99xxV is shared between a host and a SAN Volume Controller, ShadowImage is not supported on the ports that are zoned directly with the host.

## LU Expansion

The Lightning 99xxV supports Logical Unit expansion (LUSE). LUSE is a non-concurrent operation. LUSE is accomplished by concatenating between 2 and 26 existing logical units together. Before LUSE can be performed on a logical unit, it must be removed from an mdisk group and unmapped from the SAN Volume Controller.

**Attention:** This procedure will destroy all data that exists on the logical unit, except on a Windows system.

## TrueCopy

TrueCopy is functionally similar to Remote Copy. TrueCopy is not supported when the disk controller system is being used with the SAN Volume Controller. Even when a Lightning 99xxV is shared between a host and a SAN Volume Controller, TrueCopy is not supported on the ports that are zoned directly with the host.

## Virtual LVI

The Lightning 99xxV supports Virtual LVI/LUNs. You can use this method to modify a LUN size that the Lightning uses by dividing it into several smaller virtual LUNs. This is a non-concurrent procedure that requires you to first create existing LUNs into free space, then you must define their own LUNs using that free space. Virtual LVI/LUNs must not be managed or mapped to a SAN Volume Controller.

LUNs that are set up using either LUSE or Virtual LVI/LUNs appear as normal LUNs after they have been created. Therefore, LUNs set up using LUSE or Virtual LVI/LUNs can be used by the SAN Volume Controller after they have been created.

## Write protect

Logical units (LUs) cannot be explicitly set to be write-protected. However, some of the advanced features, such as Remote Copy, can be used to write-protect a LU as part of the function. Remote Copy must not be used for LUs in use by a SAN Volume Controller.

### Related concepts

“FlashCopy” on page 32

FlashCopy is a copy service available with the SAN Volume Controller.

“Remote Copy” on page 44

Remote Copy enables you to set up a relationship between two virtual disks, so that updates that are made by an application to one virtual disk are mirrored on the other virtual disk.

### Related information

“Configuring the HDS Lightning subsystem” on page 309

This part provides information about configuring the HDS Lightning subsystem so it can attach to a SAN Volume Controller.

## LU configuration for Lightning

Logical unit configuration for Lightning supports both RAID 1 and RAID 5 arrays.

The Lightning subsystem can have up to 8192 logical units defined, however, only 256 logical units can be mapped to a single port. Report LUNs is supported by LUN 0, so the SAN Volume Controller can detect all LUNs.

In the event that no LUN 0 is configured, the Lightning subsystem will present a pseudo-LUN at LUN 0. The inquiry data for this pseudo-LUN differs slightly from the inquiry data of normal LUNs, allowing the SAN Volume Controller to recognize it and exclude it from I/O. The pseudo-LUN will accept the report LUNs command.

The Lightning subsystem supports both open-mode attachment and S/390 attachment. The emulation mode is set when the LU is defined. All LUNs presented to an SAN Volume Controller must use open emulation. All LUNs with open emulation use a standard 512 byte block size.

The Lightning subsystem can only have certain sized logical units defined. These logical units can be expanded by merging 2 - 36 of these LUs together using the LU Size Expansion (LUSE) feature. They can also be made into several, smaller "virtual" LUNs by using the Virtual LVI/LUN feature.

### **Special LUs**

When a LU is mapped to a host, there is the option of making it a *command LUN*. These LUNs support in-band configuration commands, but not I/O. Therefore, no LUNs mapped to the SAN Volume Controller can be command LUNs.

#### **Related reference**

"Logical unit creation and deletion on HDS Lightning"

Before you create or delete a logical unit on HDS Lightning, consider the following prerequisites.

#### **Related information**

"Configuring the HDS Lightning subsystem" on page 309

This part provides information about configuring the HDS Lightning subsystem so it can attach to a SAN Volume Controller.

### **Logical unit creation and deletion on HDS Lightning**

Before you create or delete a logical unit on HDS Lightning, consider the following prerequisites.

The SAN Volume Controller supports Logical Unit expansion (called LUSE). LUSE is accomplished by integrating between 2 and 26 existing logical units together.

Before LUSE can be performed on a logical unit, it must be unmounted from a host, and have no available paths. The LUSE procedure will destroy all data that exists on the logical unit, except for logical units on a Windows system. LUSE must not be performed on any disk that is managed by the SAN Volume Controller. If data exists on a disk and you wish to bring in the data via image mode, LUSE should not be used on the disk prior to you importing the data.

#### **Related concepts**

"Storage subsystems" on page 20

A storage subsystem is a device that coordinates and controls the operation of one or more disk drives and synchronizes the operation of the drives with the operation of the system as a whole.

#### **Related tasks**

"Configuring a balanced storage subsystem" on page 260

The attachment of a storage subsystem to a SAN Volume Controller requires that some specific settings be applied to the device, some limitations are also listed for each storage type.



“Configuring FAStT disk controllers for the storage server” on page 299  
FAStT disk controllers provide functionality that is compatible with the SAN  
Volume Controller.

## Configuring settings for Lightning

The Lightning configuration interface provides functionality for configuration.

These options and settings can have a scope of a:

- Subsystem
- Port
- Logical unit

### Related reference

“Global settings for Lightning”

Global settings apply across a Lightning disk controller system.

“Controller settings for Lightning”

Controller settings are settings that apply across the entire Lightning controller.

“Port settings for Lightning” on page 316

Port settings are configurable at the port level.

“LU settings for Lightning” on page 316

Logical unit (LU) settings apply to individual LUs configured in the Lightning controller.

### Related information

“Configuring the HDS Lightning subsystem” on page 309

This part provides information about configuring the HDS Lightning subsystem so it can attach to a SAN Volume Controller.

## Global settings for Lightning

Global settings apply across a Lightning disk controller system.

The following table lists the global settings for Lightning.

*Table 33. Lightning global settings supported by the SAN Volume Controller*

Option	Lightning Default Setting	SAN Volume Controller Required Setting
Spare disk recover	Interleave	Interleave
Disk copy place	Medium	Medium
Copy operation	Correction copy and dynamic sparing	Correction copy and dynamic sparing
Read configuration data mode	Selected	Selected
PS off timer	Not selected	Not selected

### Related reference

“Configuring settings for Lightning”

The Lightning configuration interface provides functionality for configuration.

## Controller settings for Lightning

Controller settings are settings that apply across the entire Lightning controller.

Table 34. Lightning controller settings supported by the SAN Volume Controller

Option	Lightning Default Setting	SAN Volume Controller Required Setting
PCB mode	Standard	Standard

**Related reference**

“Configuring settings for Lightning” on page 315  
 The Lightning configuration interface provides functionality for configuration.

**Port settings for Lightning**

Port settings are configurable at the port level.

This topic lists those per port settings, what the Lightning defaults are, and what the required settings are for the SAN Volume Controller. Port settings for clearing LUN reservations are also listed.

There are no options available with the scope of a single controller.

- The ports are included in switch zones
- The switch zones only present the ports directly to the hosts and not to a SAN Volume Controller.

Table 35. Lightning port settings supported by the SAN Volume Controller

Option	Lightning Default Setting	SAN Volume Controller Required Setting
Address	AL/PA	AL/PA
Fabric	On	On
Connection	Point-to-Point	Point-to-Point
Security switch	On	On or off
Host type	Default	Windows

**Related reference**

“Configuring settings for Lightning” on page 315  
 The Lightning configuration interface provides functionality for configuration.

**LU settings for Lightning**

Logical unit (LU) settings apply to individual LUs configured in the Lightning controller.

Lightning LUs must be configured as described in Table 36 if the Logical Unit Number (LUN) is associated with ports in a switch zone that is accessible to the SAN Volume Controller.

Table 36. Lightning LU settings for the SAN Volume Controller

Option	Required Values	SAN Volume Controller Default Setting
Command device	Off	Off
Command security	Off	Off

**Note:** These settings only apply to LUs accessible by SAN Volume Controller.

**Related reference**

“Configuring settings for Lightning” on page 315  
The Lightning configuration interface provides functionality for configuration.

---

## Configuring the HDS Thunder subsystem

This part provides information about configuring the HDS Thunder subsystem so it can attach to a SAN Volume Controller.

### Related tasks

“Setting up a Thunder with more than four ports” on page 320  
Perform the following steps to set up a Thunder with more than four ports.

### Related reference

“Supported models of the HDS Thunder”  
The following table lists the models of the Thunder that are supported by the SAN Volume Controller.

“Supported firmware levels for HDS Thunder” on page 318  
See the following Web site for specific HDS Thunder firmware levels and the latest supported hardware. <http://www-1.ibm.com/servers/storage/support/virtual/2145.html>

“Concurrent maintenance on the HDS Thunder” on page 318  
Concurrent maintenance of the HDS Thunder 9200 and 9500V is not supported with the SAN Volume Controller.

“User interface on the HDS Thunder” on page 318  
Ensure that you are familiar with the user interface which supports the HDS Thunder subsystem.

“Sharing the HDS Thunder between host and the SAN Volume Controller” on page 319  
The HDS Thunder 9200 and 95xxV can be shared between a host and a SAN Volume Controller according to certain restrictions.

“Quorum disks on HDS Thunder” on page 320  
Managed disks presented by the Thunder 9200 and 95xxV may be chosen by the SAN Volume Controller as quorum disks.

“Advanced functions for HDS Thunder” on page 321  
The HDS Thunder provides advanced functions that may or may not be compatible with the SAN Volume Controller.

“Logical unit creation and deletion on HDS Thunder” on page 322  
Before you create or delete a logical unit on HDS Thunder, consider the following constraints.

“Configuring settings for HDS Thunder” on page 323  
The Thunder configuration interface provides functionality for configuration.

## Supported models of the HDS Thunder

The following table lists the models of the Thunder that are supported by the SAN Volume Controller.

*Table 37. Supported Thunder 9200 models*

Model	Description
Thunder 9200 Rackmount	Up to 100 disks
Thunder 9200 Deskside 20	Maximum of 20 disks
Thunder 9200 Deskside 10	Maximum of 10 disks

Table 38. Supported Thunder 95xxV models

Model	Description
Thunder 9530V Deskside/Rackmount	Supports 2 - 14 disks
Thunder 9531V Deskside	Pre-configured with 5 disks
Thunder 9532V Deskside	Pre-configured with 9 disks
Thunder 9533V Deskside	Pre-configured with 13 disks
Thunder 9570V Deskside/Rackmount	Supports 2 - 224 disks
Thunder 9580V Rackmount	Supports 5 - 449 disks
Thunder 9585V Rackmount	Supports 5 - 449 disks

#### Related information

“Configuring the HDS Thunder subsystem” on page 317

This part provides information about configuring the HDS Thunder subsystem so it can attach to a SAN Volume Controller.

## Supported firmware levels for HDS Thunder

See the following Web site for specific HDS Thunder firmware levels and the latest supported hardware. <http://www-1.ibm.com/servers/storage/support/virtual/2145.html>

**Note:** Concurrent upgrade of the controller firmware is supported with the SAN Volume Controller.

#### Related information

“Configuring the HDS Thunder subsystem” on page 317

This part provides information about configuring the HDS Thunder subsystem so it can attach to a SAN Volume Controller.

## Concurrent maintenance on the HDS Thunder

Concurrent maintenance of the HDS Thunder 9200 and 9500V is not supported with the SAN Volume Controller.

Concurrent upgrade of the controller firmware is supported with the SAN Volume Controller.

#### Related information

“Configuring the HDS Thunder subsystem” on page 317

This part provides information about configuring the HDS Thunder subsystem so it can attach to a SAN Volume Controller.

## User interface on the HDS Thunder

Ensure that you are familiar with the user interface which supports the HDS Thunder subsystem.

### In-band configuration

Ensure that you have the Thunder command LUN disabled when using the Thunder user interface.

## **DAMP**

Disk Array Management Program (DAMP) is the main configuration user interface. DAMP allows firmware upgrades, all settings to be changed, and creation and monitoring of the storage. DAMP is the only way to do the initial configuration of the subsystem.

DAMP supports an Ethernet connection to Thunder. An out-of-band CLI interface is also available with DAMP, which allows the majority of the functions that DAMP has.

## **HiCommand**

Ensure that you have access to DAMP in order to configure the settings using HiCommand.

HiCommand is another configuration user interface available for the Thunder, which also uses Ethernet as a transport. HiCommand is more restricted than DAMP. It allows basic creation of storage and some monitoring features. HiCommand works for both Thunder and Lightning subsystems.

## **Web Server**

A Web server is running on each of the controllers on the subsystem. During normal operation, the user interface only allows basic monitoring of the subsystem and displays an error log. If a controller is put into diagnostic mode by pressing the reset button on the controller, the user interface allows for firmware upgrades and subsystem configuration resets.

### **Related information**

“Configuring the HDS Thunder subsystem” on page 317

This part provides information about configuring the HDS Thunder subsystem so it can attach to a SAN Volume Controller.

## **Sharing the HDS Thunder between host and the SAN Volume Controller**

The HDS Thunder 9200 and 95xxV can be shared between a host and a SAN Volume Controller according to certain restrictions.

- The same host cannot be connected to both a SAN Volume Controller and a Thunder at the same time because Hitachi Dynamic Link Manager (HDLM) and the Subsystem Device Driver do not coexist.
- For Thunder 9200 only, a target port cannot be shared between a host and a SAN Volume Controller. In other words, if a target port is used by a SAN Volume Controller it must not be present in a switch zone which allows a host to access the port.
- Logical units (LUs) cannot be shared between a host and a SAN Volume Controller. Thus, Thunder 9200 must be set into M-TID M-LUN mode and Mapping Mode enabled on Thunder 95xx. No LU can have a LUN Number associated with a port which is zoned for host use while also having a LUN Number associated with a port which is zoned for a SAN Volume Controller.

### **Related concepts**

“Storage subsystems” on page 51

Follow these rules when planning the configuration of storage subsystems in the SAN fabric.

### **Related information**

“Configuring the HDS Thunder subsystem” on page 317

This part provides information about configuring the HDS Thunder subsystem so it can attach to a SAN Volume Controller.

## Setting up a Thunder with more than four ports

Perform the following steps to set up a Thunder with more than four ports.

1. Set the Mapping Mode to **Enabled**.
2. Divide the ports into groups of four (or two). For redundancy, at least one port from each controller should be in each group.
3. Make a note of all of the LUNs currently on the array. Each LUN that you want managed by the San Volume Controller should be in one group.
4. Divide the LUNs into groups: One group of LUNs for each group of ports.
5. From the **Host Groups** view:

- a. Select the first port in the first port group.

- b. Select **Option**

Set the port options.

Select **Logical Unit**.

From the menu, select **Modify Mapping**.

From the Modify Mapping panel:

- 1) Select a LUN from the first LUN group from the “LUN” column

- 2) Select “Host LUN” 0, and click **Add**.

This repositions the mapping to the “reserved configuration” column.

- 3) Select the next LUN from the first group

- 4) Select “Host LUN” 1, and click **Add**.

Repeat the previous step for all ports in the first port group. Ensure that the LUN and Host LUN ids are identical for all ports. Failure to make identical will result in I/O failures.

- 5) Repeat the previous two steps for all port groups.

### Related information

“Configuring the HDS Thunder subsystem” on page 317

This part provides information about configuring the HDS Thunder subsystem so it can attach to a SAN Volume Controller.

## Quorum disks on HDS Thunder

Managed disks presented by the Thunder 9200 and 95xxV may be chosen by the SAN Volume Controller as quorum disks.

Managed disks presented by the Thunder 9200 and 95xxV may be chosen by the SAN Volume Controller as quorum disks during initialization of the cluster. The selection made can be changed by the following methods:

- **Set quorum disk** command
- Setting a Quorum Disk panel

### Related information

“Configuring the HDS Thunder subsystem” on page 317

This part provides information about configuring the HDS Thunder subsystem so it can attach to a SAN Volume Controller.

“Creating a quorum disk” on page 272

A quorum disk is used to resolve tie-break situations when the “voting set” of nodes disagree on the current cluster state.

## Advanced functions for HDS Thunder

The HDS Thunder provides advanced functions that may or may not be compatible with the SAN Volume Controller.

### ShadowImage

ShadowImage is functionally similar to FlashCopy. ShadowImage is not supported when the disk controller system is being used with the SAN Volume Controller. Even when a HDS Thunder is shared between a host and a SAN Volume Controller, ShadowImage is not supported on the ports that are zoned directly with the host.

### TrueCopy

TrueCopy is functionally similar to Remote Copy. TrueCopy is not supported when the disk controller system is being used with the SAN Volume Controller. Even when a HDS Thunder is shared between a host and a SAN Volume Controller, TrueCopy is not supported on the ports that are zoned directly with the host.

### LUN Security

LUN Security enables LUN masking by the WWN of the initiator port. This function is not supported for logical units (LUs) used by the SAN Volume Controller.

### Partitioning

Thunder supports Partitioning. Partitioning is splitting a RAID array into up to 128 smaller LUs, each of which behaves as an independent disk like entity. The SAN Volume Controller fully supports this function.

### Dynamic array expansion

The Thunder allows the last LU defined in a RAID group to be expanded. This function is not supported with the SAN Volume Controller attachment. It must **not** be used for LUs in use by a SAN Volume Controller.

**Note:** Use in this context means that the LU has an LUN number that is associated with a fibre-channel port, and this fibre-channel port is contained in a switch zone that also contains SAN Volume Controller fibre-channel ports.

### Host storage domains (HSD) and virtual fibre-channel ports for Thunder 95xxV

The Thunder 95xxV supports host storage domains (HSD) and virtual fibre-channel ports. Each fibre-channel port may support multiple HSDs. Each host in a given HSD is essentially presented with a virtual target port and a unique set of LUNs.

The Thunder 9200 does not support HSD and virtual fibre-channel ports.

#### Related concepts

“FlashCopy” on page 32

FlashCopy is a copy service available with the SAN Volume Controller.

“Remote Copy” on page 44

Remote Copy enables you to set up a relationship between two virtual disks, so that updates that are made by an application to one virtual disk are mirrored on the other virtual disk.

### **Related information**

“Configuring the HDS Thunder subsystem” on page 317

This part provides information about configuring the HDS Thunder subsystem so it can attach to a SAN Volume Controller.

## **Logical unit creation and deletion on HDS Thunder**

Before you create or delete a logical unit on HDS Thunder, consider the following constraints.

The Thunder configuration interface enables you to create and delete logical unit number (LUNs). You must avoid certain creation and deletion scenarios to prevent data corruption. This topic discusses those scenarios.

### **Creation and deletion scenarios**

The Thunder configuration interface enables you to create and delete LUNs. Certain creation and deletion scenarios must be avoided to prevent data corruption. For example, the configuration interface enables you to create LUN A, delete LUN A, and then create LUN B with the same unique ID as LUN A. Doing this with a SAN Volume Controller attached could cause data corruption because the SAN Volume Controller might not realize that LUN B is different than LUN A.

**Attention:** Before you delete a LUN using the Thunder configuration interface, the LUN must first be removed from the managed disk group that contains it.

### **Dynamic addition of LUNs**

Perform the following procedure to add LUNs dynamically. Using this procedure prevents the existing LUNs from rejecting I/O and returning a status of unavailable during dynamic addition of LUNs.

1. Create the new LUNs using the Disk Array Management Program (DAMP), which is the Thunder configuration tool.
2. Quiesce all I/O.
3. Perform either an offline format or an online format of all new LUNs on the controller using DAMP. Wait for the format to complete.
4. Go into the LUN mapping function of DAMP. Add mapping for the new LUN to all of the controller ports that are available to the SAN Volume Controller on the fabric.
5. Restart the controller. (Model 9200 only)
6. After the controller has restarted, restart I/O.

### **LUN mapping considerations**

If LUN mapping is used as described in the LUN mapping topic, the controller must be restarted to pick up the new LUN mapping configuration. For each managed disk group (MDisk) group that contains an MDisk that is supported by an LU on the Thunder disk controller, all virtual disks in those MDisk groups will go offline.

### **Related concepts**

“Storage subsystems” on page 20

A storage subsystem is a device that coordinates and controls the operation of one or more disk drives and synchronizes the operation of the drives with the operation of the system as a whole.



“Managed disks” on page 21

A managed disk (MDisk) is a logical disk (typically a RAID array or partition thereof) that a storage subsystem has exported to the SAN fabric to which the nodes in the cluster are attached.

**Related reference**

“Mapping and virtualization settings for HDS Thunder” on page 327

Thunder supports different modes of operation. These modes affect LUN mapping or masking and virtualization.

**Related information**

“Configuring the HDS Thunder subsystem” on page 317

This part provides information about configuring the HDS Thunder subsystem so it can attach to a SAN Volume Controller.

## Configuring settings for HDS Thunder

The Thunder configuration interface provides functionality for configuration.

These options and settings can have a scope of a:

- Subsystem
- Port
- Logical unit

**Related concepts**

“Storage subsystems” on page 20

A storage subsystem is a device that coordinates and controls the operation of one or more disk drives and synchronizes the operation of the drives with the operation of the system as a whole.

**Related tasks**

“Configuring a balanced storage subsystem” on page 260

The attachment of a storage subsystem to a SAN Volume Controller requires that some specific settings be applied to the device, some limitations are also listed for each storage type.

**Related reference**

“Global settings for the HDS Thunder” on page 324

Global settings apply across a Thunder disk controller system.

“Controller settings for HDS Thunder” on page 325

Controller settings are settings that apply across the entire HDS Thunder controller. There are no options available with the scope of a single controller.

“Port settings for the HDS Tunder” on page 325

Port settings are configurable at the port level.

“LU settings for the HDS Thunder” on page 326

Logical unit (LU) settings apply to individual LUs configured in the Thunder controller.

“Mapping and virtualization settings for HDS Thunder” on page 327

Thunder supports different modes of operation. These modes affect LUN mapping or masking and virtualization.

**Related information**

“Configuring the HDS Thunder subsystem” on page 317

This part provides information about configuring the HDS Thunder subsystem so it can attach to a SAN Volume Controller.

“Servicing storage subsystems” on page 273

When servicing your storage subsystems, it is imperative that you follow the service instructions contained in the vendor documentation.

## Global settings for the HDS Thunder

Global settings apply across a Thunder disk controller system.

The following table lists the global settings for HDS Thunder.

*Table 39. Thunder global settings supported by the SAN Volume Controller*

Option	Thunder Default Setting	SAN Volume Controller Required Setting
Start attribute	Dual active mode	Dual active mode
SCSI ID/Port takeover mode	N/A	N/A
Default controller	N/A	N/A
Data-share mode	Used	Used
Serial number		Same as the Thunder default setting
Delay planned shutdown	0	0
Drive detach mode	False	False
Multipath controller (Thunder 9200 only)	False	False
PROCOM mode	False	False
Report status	False	False
Multipath (Array unit)	False	False
Turbo LU warning	False	False
NX mode	False	False
Auto reconstruction mode	False	False
Forced write-through mode	False	False
Changing logical unit mode 1	False	False
Multiple stream mode (Thunder 9200 only)	False	False
Multiple stream mode (write) (Thunder 95xxV only)	False	False
Multiple stream mode (read) (Thunder 95xxV only)	False	False
RAID 3 mode (Thunder 9200 only)	False	False
Target ID (9200 only) Mapping mode on 95xx	S-TID, M-LUN	M-TID, M-LUN (if sharing controller, otherwise S-TID, M-LUN)
Data striping size	16K; 32K; 64K	Any (Thunder 9200) 64K (Thunder 95xxV)
Operation if processor failure occurs	Reset the fault	Reset the fault
Command queuing	True	True
ANSI Version	N/A	N/A

Table 39. Thunder global settings supported by the SAN Volume Controller (continued)

Option	Thunder Default Setting	SAN Volume Controller Required Setting
Vendor ID	Hitachi	Hitachi
Product ID (Thunder 9200)	DF500F	DF500F
Product ID (Thunder 95xxV)	DF500F	DF600F
ROM microprogram version	<Empty>	<Empty>
RAM microprogram version	<Empty>	<Empty>
Web title	<Empty>	Any setting supported
Cache mode (Thunder 9200 only)	All off	All off
Link separation (Thunder 9200 only)	False	False
ROM Pseudo-response command processing (Thunder 9200 only)	N/A	N/A
Save data pointer response (Thunder 9200 only)	N/A	N/A
Controller identifier	False	False
RS232C error information outflow mode	Off	Any
Execute write and verify mode	True	True

### Controller settings for HDS Thunder

Controller settings are settings that apply across the entire HDS Thunder controller. There are no options available with the scope of a single controller.

### Port settings for the HDS Tunder

Port settings are configurable at the port level.

This topic lists those per port settings, what the Thunder defaults are, and what the required settings are for the SAN Volume Controller. Port settings for clearing LUN reservations are also listed.

The settings listed in the table Table 40 apply to those HDS Thunder 9200 disk controllers that are in a switch zone that contains SAN Volume Controllers. If the Thunder disk controller is shared between a SAN Volume Controller and another host, you can configure with different settings than shown if both of the following conditions are true:

There are no options available with the scope of a single controller.

- The ports are included in switch zones
- The switch zones only present the ports directly to the hosts and not to a SAN Volume Controller

Table 40. Thunder port settings supported by the SAN Volume Controller

Option	Thunder Default Setting	SAN Volume Controller Required Setting
Host connection mode 1	Standard	Standard

Table 40. Thunder port settings supported by the SAN Volume Controller (continued)

Option	Thunder Default Setting	SAN Volume Controller Required Setting
VxVM DMP mode (Thunder 9200 only)	False	False
HP connection mode	False	False
Report inquiry page 83H (Thunder 9200 only)	True	True
UA (06/2A00) suppress mode	False	False
HISUP mode	False	False
CCHS mode	False	False
Standard inquiry data expand (Thunder 9200 only)	False	False
Host connection mode 2	False	False
Product ID DF400 mode	False	False
HBA WWN report mode (Thunder 9200 only)	False	False
NACA mode	False	False
SUN cluster connection mode	False	False
Persistent RSV cluster mode	False	False
ftServer connection mode 1 (Thunder 9200 only)	False	False
ftServer connection mode 2	False	False
SRC Read Command reject	False	False
Reset/LIP mode (signal)	False	False
Reset/LIP mode (progress)	False	False
Reset ALL LIP port mode	False	False
Reset target (reset bus device mode)	False	True
Reserve mode	False	True
Reset logical unit mode	False	True
Reset logout of third party process mode	False	False
Read Frame minimum 128 byte mode (Thunder 950xxV only)	False	False
Topology	Point-to-point	Fabric

## LU settings for the HDS Thunder

Logical unit (LU) settings apply to individual LUs configured in the Thunder controller.

Logical unit (LU) settings apply to individual LUs configured in the Thunder controller. Thunder LUs must be configured as described in Table 41 on page 327 if the Logical Unit Number (LUN) is associated with ports in a switch zone that is accessible to the SAN Volume Controller.

Table 41. Thunder LU settings for the SAN Volume Controller

Option	Required Values	Default Setting
LUN default controller	Controller 0 or Controller 1	Any

**Note:** These settings only apply to LUs accessible by SAN Volume Controller.

### Data corruption scenarios to avoid

**Scenario 1:** The configuration application enables you to change the serial number for an LU. Changing the serial number also changes the unique user identifier (UID) for the LU. Since the serial number is also used to determine the WWPN of the controller ports, two LUNs cannot have the same unique ID on the same SAN because two controllers cannot have the same WWPN on the same SAN.

**Scenario 2:** The serial number is also used to determine the WWPN of the controller ports. Therefore, two LUNs must not have the same ID on the same SAN, because this results in two controllers having the same WWPN on the same SAN. This is not a valid configuration.

**Attention:** Do not change the serial number for an LU that is managed by a SAN Volume Controller because this could result in data loss or undetected data corruption.

**Scenario 3:** The configuration application enables you to create LUN A, delete LUN A, and create LUN B with the same unique ID as LUN A. Doing this with a LUN managed by a SAN Volume Controller could result in data corruption because the SAN Volume Controller might not recognize that LUN B is different than LUN A.

#### Related concepts

“Storage subsystems” on page 20

A storage subsystem is a device that coordinates and controls the operation of one or more disk drives and synchronizes the operation of the drives with the operation of the system as a whole.

#### Related tasks

“Configuring a balanced storage subsystem” on page 260

The attachment of a storage subsystem to a SAN Volume Controller requires that some specific settings be applied to the device, some limitations are also listed for each storage type.

### Mapping and virtualization settings for HDS Thunder

Thunder supports different modes of operation. These modes affect LUN mapping or masking and virtualization.

SAN Volume Controller supports the S-TID M-LUN and M-TID M-LUN modes on Thunder 9200, and Mapping Mode enabled or disabled on Thunder 95xx.

**Attention:** Thunder does not provide an interface that enables a SAN Volume Controller to detect and ensure that the mapping or masking and virtualization options are set properly. Therefore, you or someone else in your organization must ensure that these options are set as outlined in this topic.

## S-TID M-LUN modes

In S-TID M-LUN mode all LUs are accessible via all ports on Thunder with the same LUN Number on each port. This is the simplest mode and it should be used for all situations, except, where a Thunder subsystem is being shared between a host and a SAN Volume Controller.

## M-TID M-LUN modes

If a Thunder is being shared between a host and a SAN Volume Controller, then you must use M-TID M-LUN mode. Configure your Thunder so that all SAN Volume Controllers accessible LUs have the same LUN Number on all ports through which they can be accessed.

A SAN Volume Controller can access controller ports x and y. The SAN Volume Controller also sees an LU on port x that has LUN number p. In this situation the following conditions must be met:

- The SAN Volume Controller must see either the same LU on port y with LUN number p or it must not see the LU at all on port y.
- The LU should not appear as any other LUN number on port y.
- The LU must not be mapped to any Thunder port which is zoned for use directly by a host in a configuration where the Thunder is shared between a host and a SAN Volume Controller.

M-TID M-LUN mode enables LU virtualization by target port. In this mode, a single LU can be seen as different LUN numbers across all of the controller ports. For example, LU A may be LUN 0 on controller port 1, LUN 3 on controller port 2, and not visible at all on controller ports 3 and 4.

**Note:** The SAN Volume Controller does not support this.

In addition, M-TID M-LUN mode enables a single LU to be seen as multiple LUN numbers on the same controller port. For example, LU B may be LUN 1 and LUN 2 on controller port 1.

**Note:** The SAN Volume Controller does not support this.

**Note:** Thunder 9200 controllers require a reboot in order for changes to LUN mapping to take effect.

### Related concepts

“Storage subsystems” on page 20

A storage subsystem is a device that coordinates and controls the operation of one or more disk drives and synchronizes the operation of the drives with the operation of the system as a whole.

### Related tasks

“Configuring a balanced storage subsystem” on page 260

The attachment of a storage subsystem to a SAN Volume Controller requires that some specific settings be applied to the device, some limitations are also listed for each storage type.

---

## Configuring the HP StorageWorks subsystem

This part provides information about configuring the HP StorageWorks subsystem, which uses the HSG80 controller, so it can attach to a SAN Volume Controller.

Support for HSG80 based products is limited in SAN Volume Controller version 1.1.1 to a single port connection. Version 1.2.0 enables multi-port connection but this introduces some restrictions on LUN partitioning.

### Managed Disk (MDisk) Groups and MDisks

**Attention:** This topic only applies to SAN Volume Controller version 1.1.1 when only a single port connection was supported.

An MDisk group should contain either no HSG80 LUNs or LUNs that are only from a single HSG80 subsystem. **No other configuration is supported.** An MDisk group, that consists of LUNs from HSG80 storage and non-HSG80 storage, would potentially contain a single point of failure, if the HSG80 subsystem was connected to the cluster by a single port. Consequently, any virtual disks created from such a MDisk group would potentially contain a single point of failure.

#### Related concepts

“Managed disk groups” on page 24

An *MDisk group* is a collection of MDisks that jointly contain all the data for a specified set of virtual disks (VDisks).

#### Related tasks

“Configuring the HP StorageWorks controller” on page 332

To configure the HP StorageWorks HSG80 controller, complete these steps.

“Creating managed disk groups” on page 125

You can create a new managed disk (MDisk) group using the Create a Managed Disk Group wizard.

#### Related reference

“Supported models of the HP StorageWorks controller” on page 335

The following table lists the models of the HP StorageWorks controller that are supported by the SAN Volume Controller.

“Supported firmware levels for the HP StorageWorks controller” on page 336

See the following Web site for specific HP StorageWorks firmware levels and the latest supported hardware. <http://www-1.ibm.com/servers/storage/support/virtual/2145.html>

“Concurrent maintenance on the HP StorageWorks” on page 336

Concurrent maintenance is the capability to perform I/O operations to a HP StorageWorks controller while simultaneously performing maintenance operations on it.

“Configuration interface for the HP StorageWorks” on page 337

The Command Console configuration and service utility is the configuration interface for the HSG80 subsystem.

“Sharing the HP StorageWorks controller between a host and the SAN Volume Controller” on page 337

The HP StorageWorks controller can be shared between a host and a SAN Volume Controller.

“Switch zoning limitations for the HP StorageWorks subsystem” on page 338

Consider the following limitations when planning switch zoning and connection to the SAN.

“Quorum disks on HP StorageWorks” on page 338

Managed disks presented by the HP StorageWorks controllers will be chosen by the SAN Volume Controller as quorum disks.

“Support for HP StorageWorks advanced functions” on page 339  
 HP StorageWorks provides advanced functions that may or may not be compatible with the SAN Volume Controller.

“HP StorageWorks advanced functions” on page 340  
 VDisks that are created from MDisks presented by an HSG80 controller may be used in SAN Volume Controller FlashCopy mappings or SAN Volume Controller Remote Copy relationships.

“Logical unit creation and deletion on the HP StorageWorks” on page 340  
 Ensure you are familiar with the HSG80 container types for logical unit configuration.

“Configuring settings for the HP StorageWorks” on page 341  
 The HP StorageWorks HSG80 configuration interface provides configuration settings and options that are supported with the SAN Volume Controller.

**Related information**

“HP StorageWorks definitions”  
 The following terms are used in the IBM and HP documentation and have different meanings.

**HP StorageWorks definitions**

The following terms are used in the IBM and HP documentation and have different meanings.

IBM term	IBM definition	HP term	HP definition
<b>container</b>	A visual user-interface component that holds objects.	<b>container</b>	(1) Any entity that is capable of storing data, whether it is a physical device or a group of physical devices. (2) A virtual, internal controller structure representing either a single disk or a group of disk drives linked as a storageset. Stripesets and mirrorsets are examples of storageset containers that the controller uses to create units.
<b>device</b>	A piece of equipment that is used with the computer. A device does not generally interact directly with the system, but is controlled by a controller.	<b>device</b>	In its physical form, a magnetic disk that can be attached to a SCSI bus. The term is also used to indicate a physical device that has been made part of a controller configuration; that is, a physical device that is known to the controller. Units (virtual disks) can be created from devices, once the devices have been made known to the controller.



<b>just a bunch of disks (JBOD)</b>	See <i>non-RAID</i> .	<b>just a bunch of disks (JBOD)</b>	A group of single-device logical units not configured into any other container type.
<b>mirrorset</b>	See <i>RAID 1</i> .	<b>mirrorset</b>	A RAID storageset of two or more physical disks that maintains a complete and independent copy of the entire virtual disk's data. This type of storageset has the advantage of being highly reliable and extremely tolerant of device failure. Raid level 1 storagesets are referred to as mirrorsets.
<b>non-RAID</b>	Disks that are not in a redundant array of independent disks (RAID).	<b>non-RAID</b>	See <i>just a bunch of disks</i> .
<b>RAID 0</b>	RAID 0 allows a number of disk drives to be combined and presented as one large disk. RAID 0 does not provide any data redundancy. If one drive fails, all data is lost.	<b>RAID 0</b>	A RAID storageset that stripes data across an array of disk drives. A single logical disk spans multiple physical disks, allowing parallel data processing for increased I/O performance. While the performance characteristics of RAID level 0 is excellent, this RAID level is the only one that does not provide redundancy. Raid level 0 storagesets are referred to as stripesets.
<b>RAID 1</b>	A form of storage array in which two or more identical copies of data are maintained on separate media. Also known as mirrorset.	<b>RAID 1</b>	See <i>mirrorset</i> .
<b>RAID 5</b>	A form of parity RAID in which the disks operate independently, the data strip size is no smaller than the exported block size, and parity check data is distributed across the disks in the array.	<b>RAID 5</b>	See <i>RAIDset</i> .

<b>RAIDset</b>	See <i>RAID 5</i> .	<b>RAIDset</b>	A specially developed RAID storage set that stripes data and parity across three or more members in a disk array. A RAIDset combines the best characteristics of RAID level 3 and RAID level 5. A RAIDset is the best choice for most applications with small to medium I/O requests, unless the application is write intensive. A RAIDset is sometimes called parity RAID. RAID level 3/5 storage sets are referred to as RAIDsets.
<b>partition</b>	A logical division of storage on a fixed disk.	<b>partition</b>	A logical division of a container represented to the host as a logical unit.
<b>stripeset</b>	See <i>RAID 0</i> .	<b>stripeset</b>	See <i>RAID 0</i> .

## Configuring the HP StorageWorks controller

To configure the HP StorageWorks HSG80 controller, complete these steps.

Assume that the HP StorageWorks subsystem is not in use.

**Note:** An 8-node SAN Volume Controller cluster cannot be connected to an HSG80-based subsystem via all 4 target ports. This would exceed the limit of 96 process logins. In this type of configuration, only two of the target ports can be in the same switch zone as the SAN Volume Controller initiator ports.

1. Verify that the SAN Volume Controller front panel is clear of errors.
2. Ensure that the HP StorageWorks Operator Control Panel (OCP) on each HSG80 controller is clear of errors. The Operator Control Panel consists of seven green LED's at the rear of each HSG80 controller.
3. Ensure that you can use an HP StorageWorks command-line interface (CLI) to configure the HSG80 controllers.
4. Issue the **SHOW THIS** command and **SHOW OTHER** command to verify the following:
  - a. That the controller software is at the supported level. See <http://www-1.ibm.com/servers/storage/support/virtual/2145.html>.
  - b. Ensure that the controllers are configured for MULTIBUS FAILOVER with each other.
  - c. Ensure that the controllers are running in SCSI-3 mode.
  - d. Ensure that MIRRORING\_CACHE is enabled.
  - e. Ensure that the Host Connection Table is *not* locked.
5. Issue the **SHOW DEVICES FULL** command to verify the following:
  - a. Ensure that none of the LUNs are TRANSPORTABLE.
  - b. Ensure that all LUNs are configured. For example, the LUNs report their serial numbers and TRANSFER\_RATE\_REQUESTED correctly.

6. Issue the **SHOW FAILEDSET** command to verify that there are no failing disks.
 

**Note:** To verify, there should be no orange lights on any disks in the subsystem.
7. Issue the **SHOW UNITS FULL** command to verify the following:
  - a. Ensure that all LUNs are set to RUN and NOWRITEPROTECT
  - b. Ensure that all LUNs are ONLINE to either THIS or OTHER controller.
  - c. Ensure that all LUNs that are to be made available to the SAN Volume Controller have ALL access.
  - d. Ensure that all LUNs have Host Based Logging NOT specified.
8. If you have partitioned LUNs, refer to the HP StorageWorks controllers topic.
9. Issue the **SHOW CONNECTIONS FULL** command to verify that you have enough spare entries for all combinations of SAN Volume Controller ports and HP StorageWorks ports.
10. Connect up to four known good fibre-channel cables between your fibre-channel switches and your HP StorageWorks subsystem.
11. Ensure that your fibre-channel switches are zoned such that the SAN Volume Controller and the HP StorageWorks subsystem are in a zone. Refer to zoning a switch.
12. Issue the **SHOW THIS** command and **SHOW OTHER** command to verify that each connected port is running. Something similar to the following output should be displayed: `PORT_1_TOPOLOGY=FABRIC` (fabric up).
13. Issue the **SHOW CONNECTIONS FULL** command to verify that the new connections have appeared for each SAN Volume Controller port and HP StorageWorks port combination.
14. Verify that No rejected hosts is displayed at the end of the SHOW CONNECTIONS output.
15. On the SAN Volume Controller, issue the **svctask detectmdisk** command to discover the controller.
16. Issue the **svcinfolcontroller** command to verify that the two HSG80 serial numbers appear under the `ctrl s/n`.
17. Issue the **svcinfolmdisk** command to verify that the additional MDisks that correspond to the UNITS shown in the HP StorageWorks subsystem.

You can now use the SAN Volume Controller commands to create an MDisk group. You can also create and map VDIs from these MDisk groups. Check your SAN Volume Controller front panel has no errors. Once you ensure that your host has reloaded its fibre-channel driver then you should be able to perform I/O to the VDIs. See the *IBM TotalStorage SAN Volume Controller: Host Attachment Guide* for detailed information.

#### **Related tasks**

“Creating managed disk (MDisk) groups using the CLI” on page 188  
You can create an MDisk group using the command-line interface (CLI).

“Create virtual disks (VDIs)” on page 191  
You can create a VDisk using the command-line interface (CLI).

#### **Related reference**

“HP StorageWorks controllers” on page 334  
The SAN Volume Controller supports HP StorageWorks Controllers.

“Switch zoning for the SAN Volume Controller” on page 351  
Consider these constraints when zoning a switch.

## HP StorageWorks controllers

The SAN Volume Controller supports HP StorageWorks Controllers.

The SAN Volume Controller version 1.2.0 and later supports up to four fibre-channel connections per HP StorageWorks subsystem. The support for partitioned LUNs is restricted to a single fibre-channel connection.

**Attention:** Before making any changes to your system, consider backing up important data.

If you issue the HP StorageWorks command SHOW UNITS, any units that are partitioned are shown. The following table shows an example.

Table 42. Determining partition usage

HSG80 "SHOW UNITS" LUN	Uses	Used by
D1	R50	
D2	R52	
D3	R53	(partition)
D4	R54	
D5	DISK50000	(partition)
D6	D51	
D7	DISK30300	(partition)
D8	DISK10000	(partition)
D9	R55	

Here *D3*, *D5*, *D7* and *D8* are partitioned units.

### Scenario 1

This scenario assumes that you have no partitioned units on any HP StorageWorks controllers.

If there are no partitions on any of the HP StorageWorks controllers that are or will be connected to the SAN Volume Controller, then simply ensuring that the SAN Volume Controller code, version 1.2.0, is installed on each of the SAN Volume Controller clusters is all that is necessary. Once this code level is present and running correctly, then additional fibre channel connections can be zoned (and physically connected).

### Scenario 2

This scenario assumes that you are using HP StorageWorks controllers on the SAN Volume Controller code, version 1.1.1, with a single fibre channel attached or zoned in. If partitions are present on the HP StorageWorks controllers, then there are two options available:

#### Option 1: Migrate data from the partitioned units

Migrate data residing on partitioned units and then delete the partitioned units. Perform the following steps to migrate your data:

1. Perform a concurrent code load to get the code to version 1.2.0.

2. Migrate data residing on partitioned units. This can be done in two ways:
  - a. Migrate all virtual disks, using the **svctask migratevdisk**, that are in groups that include at least one partitioned unit to groups that contain no partitioned units. You can use the **svcinfolismdisk** command and the "SHOW UNITS FULL" command to correlate which HP StorageWorks units correspond with which MDisks on the SAN Volume Controller by comparing the unit identifiers (UIDs).
  - b. Or, ensure that the managed disks groups have enough unused space on the MDisks that correspond to unpartitioned units for a copy of all the data on MDisks that correspond to the partitioned units. Then, delete the MDisks using the **svctask rmmdisk** command, which may require the use of the force flag.
3. Rezone to take advantage of the extra ports on the HP StorageWorks controller.

### Option 2: Retain partitioned units

Perform a concurrent code load to get the SAN Volume Controller code to version 1.2.0. Retain the partitioned units and continue using a single fibre channel attachment.

**Note:** You must not zone in any additional fibre channel ports on the HP StorageWorks controller because MDisks based on partitioned units will be taken offline. If you have partitioned LUNs that are not allocated to unit numbers and you subsequently add these to your configuration, then these units must be online to the controller that has the zoned in fibre channel port. You can accomplish this by pressing the reset button on the other controller. This is only necessary for unmanaged MDisks.

### Scenario 3

This scenario assumes that you have partitions present on a HP StorageWorks controller that is to be connected to the SAN Volume Controller already running version 1.2.0.

In this case, you must initially zone in a single fibre channel connection to one of the HP StorageWorks controllers, and ensure that all the units are online to this controller. You can accomplish this by pressing the reset button on the other controller. You can then choose from the two options shown in Scenario 2. You won't need to do the concurrent code load as the code is already at version 1.2.0.

## Supported models of the HP StorageWorks controller

The following table lists the models of the HP StorageWorks controller that are supported by the SAN Volume Controller.

**Attention:** The SAN Volume Controller only supports configurations in which the HSG80 cache is enabled in writeback mode. Running with only a single controller in the HSG80 subsystem results in a single point of data loss.

**Note:** Transportable disks are not supported for any models.

Table 43. Supported models of the HP StorageWorks HSG80

Model	Description
MA8000	1 controller enclosure (one or two HSG80 controllers), 3 dual bus 14 bay drive enclosures, 22U modular storage cabinet
EMA12000 D14	3 controller enclosures (each with one or two HSG80 controllers), 9 dual bus 14 bay drive enclosures, 42U modular storage cabinet
EMA12000 S14	1 controller enclosure (with one or two HSG80 controllers), 6 single bus 14 bay drive enclosures, 42U modular storage cabinet
EMA12000 Blue	1 controller enclosure (with one or two HSG80 controllers), 3 dual bus 14 bay drive enclosures, 41U modular storage cabinet
EMA16000 S14	2 controller enclosures with dual HSG80 controllers, 12 single bus 14 bay drive enclosures, wide 41U storage cabinet
EMA16000 D14	4 controller enclosures with dual HSG80 controllers, 12 dual bus 14 bay drive enclosures, wide 41U storage cabinet

## Supported firmware levels for the HP StorageWorks controller

See the following Web site for specific HP StorageWorks firmware levels and the latest supported hardware. <http://www-1.ibm.com/servers/storage/support/virtual/2145.html>

**Note:** Concurrent upgrade of the controller firmware is also not supported with the SAN Volume Controller.

## Concurrent maintenance on the HP StorageWorks

Concurrent maintenance is the capability to perform I/O operations to a HP StorageWorks controller while simultaneously performing maintenance operations on it.

**Note:** HP StorageWorks maintenance documentation uses the phrase 'rolling upgrade' in place of 'concurrent maintenance'. Please refer to this documentation as, in some instances, the level of I/O must be reduced before performing the maintenance procedure.

The HP StorageWorks Controller allows for concurrent replacement of the following components:

- Drive
- EMU
- Blower
- Dual power supply (one unit can be removed and replaced. The fans' speed increases when only one power supply unit is present.)

The following components are hot-pluggable, but maintenance concurrent with the SAN Volume Controller I/O is not supported.

- Controller

The HP StorageWorks Controller does **not** allow for concurrent replacement of the following components:

- Single power supply (in a single power supply configuration, the enclosure is disabled when the power supply fails.)
- SCSI bus cables
- I/O module
- Cache

## Configuration interface for the HP StorageWorks

The Command Console configuration and service utility is the configuration interface for the HSG80 subsystem.

The configuration and service utility can connect to the subsystem in the following ways:

- RS232
- In band over fibre channel
- Over TCP/IP to a proxy agent which then communicates with the HSG80 in band over fibre channel.

### In band

**Attention:** POTENTIAL DATA CORRUPTION

In order for the Command Console to communicate with the HSG80 controllers, the host that runs the service utility must be able to access the HSG80 ports over the SAN. This host could therefore also access LUs that are visible to SVC and cause data corruption. To avoid this, set the UNIT\_OFFSET option to 199 for all connections to this host. This ensures that the host is only able to see the CCL.

#### Related reference

“Connection settings for the HP StorageWorks” on page 344

The HP StorageWorks HSG80 includes options that are configurable at the connection level.

## Sharing the HP StorageWorks controller between a host and the SAN Volume Controller

The HP StorageWorks controller can be shared between a host and a SAN Volume Controller.

- A host must not be connected to both a SAN Volume Controller and a HP StorageWorks HSG80 subsystem at the same time.
- Target ports must not be shared between a host and a SAN Volume Controller. Specifically, if a controller port is being used by a SAN Volume Controller it must not be present in a switch zone which enables a host to access the port.
- LU's and RAID arrays must not be shared between a host and a SAN Volume Controller.
- Partitions in the same container must all be either on the SAN Volume Controller or on hosts.

#### Related concepts

“Storage subsystems” on page 51

Follow these rules when planning the configuration of storage subsystems in the SAN fabric.

## Switch zoning limitations for the HP StorageWorks subsystem

Consider the following limitations when planning switch zoning and connection to the SAN.

**Attention:** HSG80 based subsystems are supported with a single controller or dual controllers in the subsystem. Since the SAN Volume Controller only supports configurations in which the HSG80 cache is enabled in write-back mode, running with only a single controller in the HSG80 subsystem results in a single point of data loss.

### Switch zoning

For code version 1.1.1, regardless of whether the subsystem uses one or two HSG80 controllers, only a single fibre-channel (FC) port attached to the subsystem can be present in a switch zone that contains SAN Volume Controller FC ports. This guarantees that the nodes in the cluster can access at most one port on an HSG80 subsystem.

For code version 1.2.0, switches should be zoned so that ports on the HSG80 are in the switch zone which contains all ports of the SAN Volume Controller nodes.

### Connecting to the SAN

Multiple ports from an HSG80 should be physically connected to the fibre-channel SAN in order to enable servicing of the subsystem. However, switch zoning must be used in the manner outlined in this topic.

**Note:** If the HPQ Command Console is not able to access an FC port on each of the controllers in a two-controller subsystem, there is a risk of an undetected single point of failure.

If you're using partitioned containers then there are restrictions on the way the HSG80 should be connected to the SAN Volume Controller nodes.

#### Related reference

“Switch zoning for the SAN Volume Controller” on page 351

Consider these constraints when zoning a switch.

## Quorum disks on HP StorageWorks

Managed disks presented by the HP StorageWorks controllers will be chosen by the SAN Volume Controller as quorum disks.

The SAN Volume Controller uses a logical unit (LU) presented by an HSG80 controller as a quorum disk. It will provide a quorum disk even if the connection is by a single port, although this is not recommended. If you are connecting the HSG80 subsystem with a single fibre, then you should ensure that you have another subsystem on which to put your quorum disk. Use the command line **svctask setquorum** to move quorum disks to another subsystem.



Managed disks provided by HSG80 may be chosen by the SAN Volume Controller software as quorum disks and can be set as quorum disks using the command-line interface. This means that clusters attached only to the HSG80 controllers are supported.

**Related reference**

“Configuring and servicing storage subsystems” on page 253

Follow the guidelines and procedures outlined in this section to make the most of the performance available from your storage subsystems and to avoid potential I/O problems.

**Related information**

“Creating a quorum disk” on page 272

A quorum disk is used to resolve tie-break situations when the “voting set” of nodes disagree on the current cluster state.

## Support for HP StorageWorks advanced functions

HP StorageWorks provides advanced functions that may or may not be compatible with the SAN Volume Controller.

FlashCopy and Remote Copy facilities are provided as advanced functions on the HSG80 controller, however, these controller-delivered copy services are not supported by SAN Volume Controller.

### Partitioning

HSG80 supports Partitioning. A partition is a logical division of a container, represented to the host as a logical unit (LU). A container can be a RAID array or a JBOD. Any container type is a candidate for partitions. Any non-transportable disk or storage set can be divided into a maximum of 8 partitions.

Use of this feature is subject to the following restrictions:

- Partitioned containers are fully supported if the HSG80 subsystem is connected to the SAN by a single port.
- Partitioned containers will not be configured by the SAN Volume Controller if the HSG80 subsystem is connected to the SAN by multiple ports.
- Partitioned containers will be removed from the configuration if a single port connection becomes a multi-port connection.
- Partitioned containers will be configured if a multi-port connection becomes a single port connection.

It is recommended that containers are partitioned such that no spare capacity exists because there is no way to detect this ‘unused’ partition. With a multi-port connection, subsequent attempts to use this capacity will remove all partitions on the container from the configuration.

### Dynamic array expansion (LU expansion)

HSG80 does not provide this feature.

### Write protection of LUNs

This feature is not supported for use with the SAN Volume Controller.

## HP StorageWorks advanced functions

VDisks that are created from MDisks presented by an HSG80 controller may be used in SAN Volume Controller FlashCopy mappings or SAN Volume Controller Remote Copy relationships.

That is, SAN Volume Controller copy services fully supports the use of MDisks presented by an HSG80 controller.

### Related concepts

“Remote Copy” on page 44

Remote Copy enables you to set up a relationship between two virtual disks, so that updates that are made by an application to one virtual disk are mirrored on the other virtual disk.

## Logical unit creation and deletion on the HP StorageWorks

Ensure you are familiar with the HSG80 container types for logical unit configuration.

Table 44 lists the valid container types.

Table 44. HSG80 container types for logical unit configuration

Container	Number of Members	Maximum Size
JBOD - non-transportable  <b>Attention:</b> Provides no redundancy at the physical disk drive level, that is, a single disk failure may result in the loss of an entire managed disk group and its associated virtual disks.	1	disk size minus metadata
Mirrorset	2 to 6	smallest member
RAIDset	3 to 14	1.024 terabytes
Stripeset	2 to 24	1.024 terabytes
Striped Mirrorset	2 to 48	1.024 terabytes

**Note:** Logical units can be created and deleted on an HSG80 subsystem while I/O operations are performed to other LUs. You do not need to reboot the HSG80 subsystem.

### Related concepts

“Storage subsystems” on page 20

A storage subsystem is a device that coordinates and controls the operation of one or more disk drives and synchronizes the operation of the drives with the operation of the system as a whole.

### Related tasks

“Configuring a balanced storage subsystem” on page 260

The attachment of a storage subsystem to a SAN Volume Controller requires that some specific settings be applied to the device, some limitations are also listed for each storage type.

## Configuring settings for the HP StorageWorks

The HP StorageWorks HSG80 configuration interface provides configuration settings and options that are supported with the SAN Volume Controller.

These options and settings can have a scope of a:

- Subsystem (global)
- Controller
- Port
- Logical unit
- Connection

### Related concepts

“Storage subsystems” on page 20

A storage subsystem is a device that coordinates and controls the operation of one or more disk drives and synchronizes the operation of the drives with the operation of the system as a whole.

### Related tasks

“Configuring a balanced storage subsystem” on page 260

The attachment of a storage subsystem to a SAN Volume Controller requires that some specific settings be applied to the device, some limitations are also listed for each storage type.

### Related reference

“Global settings for the HP StorageWorks”

Global settings apply across a HP StorageWorks HSG80 subsystem.

“Controller settings for the HP StorageWorks” on page 342

Controller settings are settings that apply across one HSG80 controller.

“Port settings for the HP StorageWorks” on page 343

Port settings are configurable at the port level.

“LU settings for the HP StorageWorks” on page 343

LU settings are configurable at the LU level.

“Connection settings for the HP StorageWorks” on page 344

The HP StorageWorks HSG80 includes options that are configurable at the connection level.

“Mapping and virtualization settings for the HP StorageWorks” on page 345

Consider these constraints for LUN mapping or masking and virtualization from the point of view of the HSG80 controller and their use in a SAN Volume Controller environment.

### Related information

“Servicing storage subsystems” on page 273

When servicing your storage subsystems, it is imperative that you follow the service instructions contained in the vendor documentation.

## Global settings for the HP StorageWorks

Global settings apply across a HP StorageWorks HSG80 subsystem.

Table 45. HSG80 global settings supported by the SAN Volume Controller

Option	HSG80 Default Setting	SAN Volume Controller Required Setting
DRIVE_ERROR_THRESHOLD	800	Default
FAILEDSET	Not defined	n/a

### Related concepts

“Storage subsystems” on page 20

A storage subsystem is a device that coordinates and controls the operation of one or more disk drives and synchronizes the operation of the drives with the operation of the system as a whole.

### Related tasks

“Configuring a balanced storage subsystem” on page 260

The attachment of a storage subsystem to a SAN Volume Controller requires that some specific settings be applied to the device, some limitations are also listed for each storage type.

## Controller settings for the HP StorageWorks

Controller settings are settings that apply across one HSG80 controller.

Table 46 describes the options that can be set by HSG80 command-line interface (CLI) commands for each controller.

Table 46. HSG80 controller settings supported by the SAN Volume Controller

Option	HSG80 Default Setting	SAN Volume Controller Required Setting
ALLOCATION_CLASS	0	Any value
CACHE_FLUSH_TIME	10	Any value
COMMMAND_CONSOLE_LUN	Not defined	Any value
CONNECTIONS_UNLOCKED	CONNECTIONS_UNLOCKED	CONNECTIONS_UNLOCKED
NOIDENTIFIER	Not defined	No identifier
MIRRORED_CACHE	Not defined	Mirrored
MULTIBUS_FAILOVER	Not defined	MULTIBUS_FAILOVER
NODE_ID	Worldwide name as on the label	Default
PROMPT	None	Any value
REMOTE_COPY	Not defined	Any value
SCSI_VERSION	SCSI-2	SCSI-3
SMART_ERROR_EJECT	Disabled	Any value
TERMINAL_PARITY	None	Any value
TERMINAL_SPEED	9600	Any value
TIME	Not defined	Any value
UPS	Not defined	Any value

### Related concepts

“Storage subsystems” on page 20

A storage subsystem is a device that coordinates and controls the operation of one or more disk drives and synchronizes the operation of the drives with the operation of the system as a whole.

### Related tasks

“Configuring a balanced storage subsystem” on page 260

The attachment of a storage subsystem to a SAN Volume Controller requires that some specific settings be applied to the device, some limitations are also listed for each storage type.

## Port settings for the HP StorageWorks

Port settings are configurable at the port level.

**Only one port per HSG80 pair may be used with the SAN Volume Controller.**

**Note:** The port settings are set using the following commands:

- SET THIS PORT\_1\_TOPOLOGY=FABRIC
- SET THIS PORT\_2\_TOPOLOGY=FABRIC
- SET OTHER PORT\_1\_TOPOLOGY=FABRIC
- SET OTHER PORT\_2\_TOPOLOGY=FABRIC

These values can be checked using the following commands:

- SHOW THIS
- SHOW OTHER

Table 47. HSG80 port settings supported by the

Option	HSG80 Default Setting	HSG80 SAN Volume Controller Required Setting
PORT_1/2-AL-PA	71 or 72	n/a
PORT_1/2_TOPOLOGY	Not defined	FABRIC

**Note:** The HSG80 supports LUN masking using the "SET <unit number> ENABLE\_ACCESS\_PATH" command. When used with a SAN Volume Controller, ENABLE\_ACCESS\_PATH must be set to all ("SET <unit number> ENABLE\_ACCESS\_PATH=ALL") and all LUN masking handled exclusively by the SAN Volume Controller. The access rights can be checked using the "SHOW CONNECTIONS FULL" and any UNIT\_OFFSETs using the "SHOW CONNECTIONS FULL" command.

### Related concepts

"Storage subsystems" on page 20

A storage subsystem is a device that coordinates and controls the operation of one or more disk drives and synchronizes the operation of the drives with the operation of the system as a whole.

"Virtual disk-to-host mapping" on page 30

Virtual disk-to-host mapping is the process of controlling which hosts have access to specific virtual disks (VDisks) within the SAN Volume Controller.

### Related tasks

"Configuring a balanced storage subsystem" on page 260

The attachment of a storage subsystem to a SAN Volume Controller requires that some specific settings be applied to the device, some limitations are also listed for each storage type.

## LU settings for the HP StorageWorks

LU settings are configurable at the LU level.

Table 48 on page 344 describes the options that must be set for each logical unit that is accessed by the SAN Volume Controller. LUs that are accessed by hosts can be configured differently.

Table 48. HSG80 LU settings supported by the SAN Volume Controller

Option	HSG80 Default Setting	SAN Volume Controller Required Setting
TRANSFER_RATE_REQUESTED	20MHZ	n/a
TRANSPORTABLE/ NOTTRANSPORTABLE	NOTTRANSPORTABLE	NOTTRANSPORTABLE
ENABLE_ACCESS_PATH	ENABLE_ACCESS_PATH=ALL	ENABLE_ACCESS_PATH=ALL
DISABLE_ACCESS_PATH	NO DEFAULT	NO DEFAULT
IDENTIFIER/ NOIDENTIFIER	NOIDENTIFIER	n/a
MAX_READ_CACHE_SIZE	32	n/a
MAX_WRITE_CACHE_SIZE	32	64 or higher
MAX_CACHED_TRANSFER_SIZE	32	n/a
PREFERRED_PATH/ NOPREFERRED_PATH	NOPREFERRED_PATH is set	n/a
READ_CACHE/ NOREAD_CACHE	READ_CACHE	n/a
READAHEAD_CACHE/ NOREADAHEAD_CACHE	READAHEAD_CACHE	n/a
RUN/ NORUN	RUN	RUN
WRITE_LOG/NOWRITE_LOG	NOWRITE_LOG	NOWRITE_LOG
WRITE_PROTECT/ NOWRITE_PROTECT	NOWRITE_PROTECT	NOWRITE_PROTECT
WRITEBACK_CACHE/ NOWRITEBACK_CACHE	WRITEBACK_CACHE	WRITEBACK_CACHE

#### Related concepts

“Storage subsystems” on page 20

A storage subsystem is a device that coordinates and controls the operation of one or more disk drives and synchronizes the operation of the drives with the operation of the system as a whole.

#### Related tasks

“Configuring a balanced storage subsystem” on page 260

The attachment of a storage subsystem to a SAN Volume Controller requires that some specific settings be applied to the device, some limitations are also listed for each storage type.

### Connection settings for the HP StorageWorks

The HP StorageWorks HSG80 includes options that are configurable at the connection level.

Table 49. HSG80 connection options and their required settings for the

Option	HSG80 Default Setting	HSG80 Required Setting
OPERATING_SYSTEM	Not defined	WINNT
RESERVATION_STYLE	CONNECTION_BASED	n/a
UNIT_OFFSET	0	0 or 199

#### Related concepts

“Storage subsystems” on page 20

A storage subsystem is a device that coordinates and controls the operation of one or more disk drives and synchronizes the operation of the drives with the operation of the system as a whole.

#### **Related tasks**

“Configuring a balanced storage subsystem” on page 260

The attachment of a storage subsystem to a SAN Volume Controller requires that some specific settings be applied to the device, some limitations are also listed for each storage type.

#### **Related reference**

“Configuration interface for the HP StorageWorks” on page 337

The Command Console configuration and service utility is the configuration interface for the HSG80 subsystem.

## **Mapping and virtualization settings for the HP StorageWorks**

Consider these constraints for LUN mapping or masking and virtualization from the point of view of the HSG80 controller and their use in a SAN Volume Controller environment.

The HSG80 configuration interface requires you assign a unit number to each logical unit when it is defined. By default the LUN is the unit number. It is therefore possible for gaps to exist in the LUN range if the unit numbers used in the configuration commands are not contiguous. By default, each LUN is visible on all controller ports on both controllers.

### **LUN masking**

The HSG80 supports the concept of connection names. It supports a maximum of 96 connection names which contain the following parameters:

- HOST\_ID
- ADAPTER\_ID
- CONTROLLER
- PORT
- REJECTED\_HOST

**Note:** The SAN Volume Controller ports should not be in the REJECTED\_HOSTS list. This list can be seen with SHOW CONNECTIONS FULL.

LUN masking must not be used on LUs which are in use by the SAN Volume Controller to restrict either the initiator ports or the Target ports which the SAN Volume Controller uses to access the LUs. Configurations that use LUN masking in this way are not supported. LUN masking can be used to prevent other initiators on the SAN from accessing LUs which are in use by the SAN Volume Controller but the preferred method for this is to use SAN zoning.

### **LU Virtualization**

The HSG80 also provides LU virtualization by the port and by the initiator. This is achieved by specifying a UNIT\_OFFSET for the connection. The use of LU Virtualization for connections between the HSG80 target ports and initiator ports on the SAN Volume Controller is not supported.

#### **Related reference**

“Switch zoning for the SAN Volume Controller” on page 351  
Consider these constraints when zoning a switch.

---

## Configuring the HPQ Enterprise Virtual Array (EVA) subsystem

This part provides information about configuring the HPQ Enterprise Virtual Array (EVA) disk controller system so it can attach to a SAN Volume Controller.

### Related reference

“Supported models of the HPQ EVA”

The following table lists the models of the HPQ EVA that are supported by the SAN Volume Controller.

“Supported firmware levels for HPQ EVA” on page 347

See the following Web site for specific HPQ EVA firmware levels and the latest supported hardware. [http://www-](http://www-1.ibm.com/servers/storage/support/virtual/2145.html)

1.ibm.com/servers/storage/support/virtual/2145.html

“User interface on HPQ EVA” on page 347

Ensure that you are familiar with the user interface which supports the HPQ EVA subsystem.

“Sharing the HPQ EVA controller between a host and the SAN Volume Controller” on page 347

The HPQ EVA controller can be shared between a host and a SAN Volume Controller.

“Switch zoning limitations for the HPQ EVA subsystem” on page 348

Consider the following limitations when planning switch zoning and connection to the SAN.

“Quorum disks on HPQ EVA” on page 348

Managed disks presented by the HPQ EVA controllers will be chosen by the SAN Volume Controller as quorum disks.

“Support for HPQ EVA advanced functions” on page 348

HPQ EVA provides advanced functions that may or may not be compatible with the SAN Volume Controller.

“Logical unit configuration on the HPQ EVA” on page 348

An EVA logical unit is referred to as a virtual disk (VDisk). An EVA subsystem can support up to 512 VDIsks. VDIsks are created within a set of physical disk drives, referred to as a disk group. A VDisk is striped across all the drives in the group.

“Logical unit presentation” on page 349

A VDisk must be explicitly presented to a host before it can be used for I/O operations.

“Configuration interface for the HPQ EVA” on page 350

The HPQ EVA systems are configured, managed and monitored via a Storage Management Appliance. The Storage Management Appliance is a server that runs a software agent called Command View EVA. The agent is accessed via a graphical user interface that is provided by a standard Web browser.

“Configuring settings for the HPQ EVA” on page 350

The HPQ EVA configuration interface provides configuration settings and options that are supported with the SAN Volume Controller.

## Supported models of the HPQ EVA

The following table lists the models of the HPQ EVA that are supported by the SAN Volume Controller.



Table 50. Supported HPQ EVA models

Model
EVA 3000
EVA 5000

**Related information**

“Configuring the HPQ Enterprise Virtual Array (EVA) subsystem” on page 346  
This part provides information about configuring the HPQ Enterprise Virtual Array (EVA) disk controller system so it can attach to a SAN Volume Controller.

## Supported firmware levels for HPQ EVA

See the following Web site for specific HPQ EVA firmware levels and the latest supported hardware. <http://www-1.ibm.com/servers/storage/support/virtual/2145.html>

**Note:** Concurrent upgrade of the controller firmware is **not** supported with the SAN Volume Controller.

**Related information**

“Configuring the HPQ Enterprise Virtual Array (EVA) subsystem” on page 346  
This part provides information about configuring the HPQ Enterprise Virtual Array (EVA) disk controller system so it can attach to a SAN Volume Controller.

## User interface on HPQ EVA

Ensure that you are familiar with the user interface which supports the HPQ EVA subsystem.

### Storage Management Appliance

EVA systems are configured, managed and monitored via a Storage Management Appliance. This is a PC server that runs a software agent called Command View EVA. The agent is accessed via a user interface that is provided by a standard web browser.

Command View EVA communicates in-band with the HSV controllers.

**Related information**

“Configuring the HPQ Enterprise Virtual Array (EVA) subsystem” on page 346  
This part provides information about configuring the HPQ Enterprise Virtual Array (EVA) disk controller system so it can attach to a SAN Volume Controller.

## Sharing the HPQ EVA controller between a host and the SAN Volume Controller

The HPQ EVA controller can be shared between a host and a SAN Volume Controller.

- A host must not be connected to both a SAN Volume Controller and a HPQ EVA subsystem at the same time.
- LU's and RAID arrays must not be shared between a host and a SAN Volume Controller.

**Related information**

“Configuring the HPQ Enterprise Virtual Array (EVA) subsystem” on page 346  
This part provides information about configuring the HPQ Enterprise Virtual Array (EVA) disk controller system so it can attach to a SAN Volume Controller.

## Switch zoning limitations for the HPQ EVA subsystem

Consider the following limitations when planning switch zoning and connection to the SAN.

### Fabric zoning

The SAN Volume Controller switch zone must include at least one target port from each HSV controller in order to have no single point of failure.

#### Related information

“Configuring the HPQ Enterprise Virtual Array (EVA) subsystem” on page 346  
This part provides information about configuring the HPQ Enterprise Virtual Array (EVA) disk controller system so it can attach to a SAN Volume Controller.

## Quorum disks on HPQ EVA

Managed disks presented by the HPQ EVA controllers will be chosen by the SAN Volume Controller as quorum disks.

#### Related information

“Configuring the HPQ Enterprise Virtual Array (EVA) subsystem” on page 346  
This part provides information about configuring the HPQ Enterprise Virtual Array (EVA) disk controller system so it can attach to a SAN Volume Controller.

## Support for HPQ EVA advanced functions

HPQ EVA provides advanced functions that may or may not be compatible with the SAN Volume Controller.

FlashCopy and Remote Copy facilities are provided as advanced functions on the HPQ EVA controller, however, these controller-delivered copy services are not supported by SAN Volume Controller.

SAN Volume Controller FlashCopy and Remote Copy functions are fully supported for LUs presented by EVA.

EVA advanced functions VSnap and SnapClone are not supported for LUs managed by the SAN Volume Controller.

#### Related information

“Configuring the HPQ Enterprise Virtual Array (EVA) subsystem” on page 346  
This part provides information about configuring the HPQ Enterprise Virtual Array (EVA) disk controller system so it can attach to a SAN Volume Controller.

## Logical unit configuration on the HPQ EVA

An EVA logical unit is referred to as a virtual disk (VDisk). An EVA subsystem can support up to 512 VDIs. VDIs are created within a set of physical disk drives, referred to as a disk group. A VDisk is striped across all the drives in the group.

The minimum size of a disk group is 8 physical drives. The maximum size of a disk group is all available disk drives.

EVA VDIs are created and deleted using the Command View EVA utility.

**Note:** A VDisk is formatted during the creation process, therefore, the capacity of the VDisk will determine the length of time it takes to be created and formatted. Ensure that you wait until the VDisk is created before you present it to the SAN Volume Controller.

A single VDisk can consume the entire disk group capacity or the disk group may be used for multiple VDIs. The amount of disk group capacity consumed by a VDisk depends on the VDisk capacity and the selected redundancy level. There are three redundancy levels:

- Vraid 1 - High redundancy (mirroring)
- Vraid 5 - Moderate redundancy (parity striping)
- Vraid 0 - No redundancy (striping)

**Related reference**

“Logical unit creation and deletion on the HPQ EVA”  
EVA VDIs are created and deleted using the Command View EVA utility.

**Related information**

“Configuring the HPQ Enterprise Virtual Array (EVA) subsystem” on page 346  
This part provides information about configuring the HPQ Enterprise Virtual Array (EVA) disk controller system so it can attach to a SAN Volume Controller.

### **Logical unit creation and deletion on the HPQ EVA**

EVA VDIs are created and deleted using the Command View EVA utility.

VDIs are formatted during creation. The time it takes to format the VDIs depends on the capacity.

**Note:** Selecting a host for presentation at creation time is not recommended. Ensure that you wait until the VDisk has been created before presenting it to the SAN Volume Controller

## **Logical unit presentation**

A VDisk must be explicitly presented to a host before it can be used for I/O operations.

The SAN Volume Controller supports LUN masking on a EVA controller. When presenting a VDisk, the LUN can be specified or allowed to default to the next available value.

The SAN Volume Controller supports LUN virtualization on a EVA controller. The LUN-host relationship is set on a per-host basis.

**Note:** All nodes and ports in the SAN Volume Controller cluster, must be represented as one host to the EVA.

### **Special LUs**

The Console LU is a special VDisk that represents the SCSI target device. It is presented to all hosts as LUN 0.

**Related information**

“Configuring the HPQ Enterprise Virtual Array (EVA) subsystem” on page 346  
This part provides information about configuring the HPQ Enterprise Virtual Array (EVA) disk controller system so it can attach to a SAN Volume Controller.

## Configuration interface for the HPQ EVA

The HPQ EVA systems are configured, managed and monitored via a Storage Management Appliance. The Storage Management Appliance is a server that runs a software agent called Command View EVA. The agent is accessed via a graphical user interface that is provided by a standard Web browser.

### In band

The Command View EVA subsystem communicates in-band with the HSV controllers.

#### Related information

“Configuring the HPQ Enterprise Virtual Array (EVA) subsystem” on page 346  
This part provides information about configuring the HPQ Enterprise Virtual Array (EVA) disk controller system so it can attach to a SAN Volume Controller.

## Configuring settings for the HPQ EVA

The HPQ EVA configuration interface provides configuration settings and options that are supported with the SAN Volume Controller.

These options and settings can have a scope of a:

- Subsystem (global)
- Logical unit
- Host

#### Related reference

“Global settings for the HPQ EVA”  
Global settings apply across a HPQ EVA subsystem.  
“LU settings for the HPQ EVA”  
LU settings are configurable at the LU level.  
“Host settings for the HPQ EVA” on page 351  
Host settings are configurable.

#### Related information

“Configuring the HPQ Enterprise Virtual Array (EVA) subsystem” on page 346  
This part provides information about configuring the HPQ Enterprise Virtual Array (EVA) disk controller system so it can attach to a SAN Volume Controller.

## Global settings for the HPQ EVA

Global settings apply across a HPQ EVA subsystem.

The following subsystem options can be accessed via the Command View EVA.

Table 51. HPQ EVA global settings supported by the SAN Volume Controller

Option	HPQ EVA Default Setting	SAN Volume Controller Required Setting
Console LUN ID	0	Any
Disk replacement delay	1	Any

## LU settings for the HPQ EVA

LU settings are configurable at the LU level.

Table 52 on page 351 describes the options that must be set for each logical unit that is accessed by other hosts. LUs that are accessed by hosts can be configured

differently.

Table 52. HPQ EVA LU settings supported by the SAN Volume Controller

Option	HPQ EVA Default Setting	SAN Volume Controller Required Setting
Capacity	None	Any
Write cache	Mirrored Write-back	Mirrored
Read cache	On	On
Redundancy	Vraid0	Any
Preferred path	No preference	No preference
Write protect	Off	Off

## Host settings for the HPQ EVA

Host settings are configurable.

The following host options can be accessed via the Command View EVA.

Table 53. HPQ EVA host settings supported by the SAN Volume Controller

Option	HPQ EVA Default Setting	SAN Volume Controller Required Setting
OS type		Windows
Direct eventing	Disabled	Disabled

---

## Switch zoning for the SAN Volume Controller

Consider these constraints when zoning a switch.

### Overview

The number of virtual paths to each virtual disk is limited. Implementation of the following rules will help you achieve the correct number of virtual paths.

- Each host (or partition of a host) can have between one and four fibre-channel ports.
- Switch zoning should be used to ensure that each host fibre-channel port is zoned to exactly one fibre-channel port for each SAN Volume Controller node in a cluster.
- To obtain the best performance from a host with multiple fibre-channel ports, the zoning should ensure that each fibre-channel port of a host is zoned with a different group of SAN Volume Controller ports.
- To obtain the best overall performance of the subsystem, the workload for each SAN Volume Controller port should be equal. This will typically involve zoning roughly the same number of host fibre channel ports to each SAN Volume Controller fibre-channel port.

IBM recommends that you manually set the domain IDs prior to building the multiswitch fabric and prior to zoning for the following reasons:

- When two switches are joined while active, they will determine if the domain ID is already in use as before, but if there is a conflict it cannot be changed in an active switch. This conflict will cause the fabric merging process to fail.

- The domain ID is used to identify switch ports when zoning is implemented using the domain and switch port number. If domain IDs are negotiated at every fabric start up, there is no guarantee that the same switch will have the same ID the next time. Therefore, zoning definitions can become invalid.
- If the domain ID is changed after a SAN is set up, some host systems may have difficulty logging back in with the switch, and it may be necessary to reconfigure the host in order to detect devices on the switch again.

The maximum number of paths from the SAN Volume Controller nodes to a host is eight. The maximum number of host bus adapter (HBA) ports is four (for example, no more than two two-port HBAs or four one-port HBAs).

In the following example, consider the following SAN environment:

- Two SAN Volume Controller nodes, nodes A and B
- Nodes A and B have four ports each
  1. Node A has ports A0, A1, A2, and A3
  2. Node B has ports B0, B1, B2, and B3
- Four hosts called P, Q, R, and S
- Each of the four hosts has four ports, as described in Table 54.

*Table 54. Four hosts and their ports*

<b>P</b>	<b>Q</b>	<b>R</b>	<b>S</b>
P0	Q0	R0	S0
P1	Q1	R1	S1
P2	Q2	R2	S2
P3	Q3	R3	S3

- Two switches called X and Y
- One storage controller
- The storage controller has four ports on it called I0, I1, I2, and I3

An example configuration would be the following:

1. Attach ports 1 (A0, B0, P0, Q0, R0, and S0) and 2 (A1, B1, P1, Q1, R1, and S1) of each node and host to switch X.
2. Attach ports 3 (A2, B2, P2, Q2, R2, and S2) and 4 (A3, B3, P3, Q3, R3, and S3) of each node and host to switch Y.
3. Attach ports 1 and 2 (I0 and I1) of the storage controller to switch X.
4. Attach ports 3 and 4 (I2 and I3) of the storage controller to switch Y.

On switch X we would create the following host zones:

5. Create a host zone containing ports 1 (A0, B0, P0, Q0, R0, and S0) of each node and host.
6. Create a host zone containing ports 2 (A1, B1, P1, Q1, R1, and S1) of each node and host.

Similarly, on switch Y we would create the following host zones:

7. Create a host zone on switch Y containing ports 3 (A2, B2, P2, Q2, R2, and S2) of each node and host.
8. Create a host zone on switch Y containing ports 4 (A3, B3, P3, Q3, R3, and S3) of each node and host.

Last, we would create the following storage zone:

9. Create a storage zone that is configured on each switch. Each storage zone contains all the SAN Volume Controller and storage ports on that switch.

In the following example, the SAN environment is similar to the first example, with two additional hosts with two ports each.

- Two SAN Volume Controller nodes called A and B
- Nodes A and B have four ports each
  1. Node A has ports A0, A1, A2, and A3
  2. Node B has ports B0, B1, B2, and B3
- Six hosts called P, Q, R, S, T and U
- Four hosts have four ports each, and two hosts have two ports each as described in Table 55.

Table 55. Six hosts and their ports

P	Q	R	S	T	U
P0	Q0	R0	S0	T0	U0
P1	Q1	R1	S1	T1	U1
P2	Q2	R2	S2	—	—
P3	Q3	R3	S3	—	—

- Two switches called X and Y
- One storage controller
- The storage controller has four ports on it called I0, I1, I2, and I3

An example configuration would be the following:

1. Attach ports 1 (A0, B0, P0, Q0, R0, S0 and T0) and 2 (A1, B1, P1, Q1, R1, S1 and T1) of each node and host to switch X.
2. Attach ports 3 (A2, B2, P2, Q2, R2, S2 and T2) and 4 (A3, B3, P3, Q3, R3, S3 and T3) of each node and host to switch Y.
3. Attach ports 1 and 2 (I0 and I1) of the storage controller to switch X.
4. Attach ports 3 and 4 (I2 and I3) of the storage controller to switch Y.

**Attention:** Hosts T and U (T0 and U0) and (T1 and U1) are zoned to different SAN Volume Controller ports so that each SAN Volume Controller port is zoned to the same number of host ports.

On switch X we would create the following host zones:

5. Create a host zone containing ports 1 (A0, B0, P0, Q0, R0, S0 and T0) of each node and host.
6. Create a host zone containing ports 2 (A1, B1, P1, Q1, R1, S1 and T1) of each node and host.

Similarly, on switch Y we would create the following host zones:

7. Create a host zone on switch Y containing ports 3 (A2, B2, P2, Q2, R2, S2 and T2) of each node and host.
8. Create a host zone on switch Y containing ports 4 (A3, B3, P3, Q3, R3, S3 and T3) of each node and host.

Last, we would create the following storage zone:

9. Create a storage zone configured on each switch. Each storage zone contains all the SAN Volume Controller and storage ports on that switch.

### Related reference

“Switch zoning limitations for the EMC CLARiiON” on page 279

There are limitations in switch zoning for the SAN Volume Controller and EMC CLARiiON.

“Fibre-channel switches” on page 57

Follow these guidelines for configuring the fibre-channel switches that are supported on the SAN.

## Zoning considerations for Remote Copy

Consider these constraints when zoning a switch to support the Remote Copy service.

SAN configurations that use the Remote Copy feature between two clusters need additional switch zoning considerations. These considerations include:

- Additional zones for remote copy. For Remote Copy operations involving two clusters, these clusters must be zoned so that the nodes in each cluster can see the ports of the nodes in the other cluster.
- Use of extended fabric settings in a switched fabric.
- Use of Inter Switch Link (ISL) trunking in a switched fabric.
- Use of redundant fabrics.

**Note:** These considerations do not apply if the simpler, intracluster mode of Remote Copy operation is in use, when only a single cluster is needed.

For intracluster Remote Copy relationships, no additional switch zones are required. For intercluster Remote Copy relationships, you must:

1. Form a SAN that contains both clusters that are to be used in the Remote Copy relationships. If cluster A is in SAN A originally, and cluster B is in SAN B originally, this means that there must be at least one fibre-channel connection between SAN A and SAN B. This connection will be one or more inter-switch links. The fibre-channel switch ports associated with these inter-switch ports should not appear in any zone.
2. A single SAN can only be formed out of combining SAN A and SAN B if the domain numbers of the switches in each SAN are different, prior to the connection of the two SANs. You should ensure that each switch has a different domain ID before connecting the two SANs.
3. Once the switches in SAN A and SAN B are connected, they should be configured to operate as a single group of switches. Each cluster should retain the same set of zones that were required to operate in the original single SAN configuration.
4. A new zone must be added that contains all the switch ports that are connected to SAN Volume Controller ports. This will contain switch ports that were originally in SAN A and in SAN B.
5. You can adjust the switch zoning so that the hosts originally in SAN A can see cluster B. This allows a host to examine data in both the local and remote cluster if required. This view of both clusters is purely optional and in some cases may complicate the way you operate the overall system, therefore, unless specifically needed, it should not be implemented.
6. You should verify that the switch zoning is such that cluster A cannot see any of the back-end storage owned by cluster B. Two clusters may not share the same back-end storage devices.



The following zones would therefore be needed in a typical intercluster Remote Copy configuration:

1. A zone in the local cluster that contains all the ports in the SAN Volume Controller nodes in that local cluster and the ports on the backend storage associated with that local cluster. These zones would be required whether or not Remote Copy is in use.
2. A zone in the remote cluster that contains all the ports in the SAN Volume Controller nodes in that remote cluster and the ports on the back-end storage associated with that remote cluster. These zones would be required whether or not Remote Copy is in use.
3. A zone that contains all the ports in the SAN Volume Controller nodes in both the local and remote cluster. This zone is required for intercluster communication and is specifically required by Remote Copy.
4. Additional zones that contain ports in host HBAs and selected ports on the SAN Volume Controller nodes in a particular cluster. These are the zones that allow a host to see VDisks presented by an I/O group in a particular cluster. These zones would be required whether or not Remote Copy were in use.

**Note:**

1. While it is normal to zone a server connection so that it is only visible to the local or remote cluster, it is also possible to zone the server so that the host HBA can see nodes in both the local and remote cluster at the same time.
2. Intracluster Remote Copy operation does not require any additional zones, over and above those needed to run the cluster itself.

## Switch operations over long distances

Some SAN switch products provide features that allow the users to tune the performance of I/O traffic in the fabric in a way that can affect Remote Copy performance.

The two most significant features are ISL trunking and extended fabric.

<b>ISL trunking</b>	<p>Trunking enables the switch to use two links in parallel and still maintain frame ordering. It does this by routing all traffic for a given destination over the same route even when there may be more than one route available. Often trunking is limited to certain ports or port groups within a switch. For example, in the IBM 2109-F16 switch, trunking can only be enabled between ports in the same quad (for example, same group of four ports). For more information on trunking with the MDS, refer to "Configuring Trunking" on the Cisco Systems Web site.</p> <p>Some switch types may impose limitations on concurrent use of trunking and extended fabric operation. For example, with the IBM 2109-F16 switch, it is not possible to enable extended fabric for two ports in the same quad. Thus, extended fabric and trunking are effectively mutually exclusive. (Although it is possible, to enable extended fabric operation one link of a trunked pair this does not offer any performance advantages and adds complexity to the configuration setup. This mixed mode of operation is therefore not recommended.)</p>
---------------------	---

<b>Extended fabric</b>	<p>Extended fabric operation allocates extra buffer credits to a port. This is important over long links usually found in inter-cluster remote copy operation because, due to the time it takes for a frame to traverse the link, it is possible to have more frames in transmission at any instant in time than would be possible over a short link. The additional buffering is required to allow for the extra frames.</p> <p>For example, the default license for the IBM 2109-F16 switch has two extended fabric options, Normal and Extended Normal.</p> <ul style="list-style-type: none"><li>• Normal is suitable for short links and Extended Normal is suitable for links up to 10km long. (With the additional Extended fabric license the user gets two extra options, Medium, up to 10-50km and Long, 50-100km.)</li><li>• The Extended Normal setting gives significantly better performance for the links up to 10 km long. Medium and Long settings are not recommended for use in the inter-cluster remote copy links currently supported.</li></ul>
------------------------	---

---

## Reference

This part provides reference information for the SAN Volume Controller.

---

### Installing or upgrading the IBM TotalStorage SAN Volume Controller Console for Windows

This part provides an overview of the installation process and instructions for installing or upgrading and configuring the IBM TotalStorage SAN Volume Controller Console on a Windows 2000 Server operating system.

**Note:** Installing the SAN Volume Controller Console on your host system is optional. The SAN Volume Controller Console comes preinstalled on the master console.

#### Related tasks

“Installing or upgrading the SAN Volume Controller Console in graphical mode” on page 361

If you choose to install or upgrade the IBM TotalStorage SAN Volume Controller Console in unattended mode skip this section. You must satisfy all prerequisites before starting the installation.

“Installing or upgrading the SAN Volume Controller Console in unattended (silent) mode” on page 366

The unattended (silent) mode install or upgrade option enables you to run the installation or upgrade installation unattended.

“Verifying the Windows services associated with the SAN Volume Controller Console” on page 371

To verify that the Windows services associated with your IBM TotalStorage SAN Volume Controller Console are correctly installed and started, complete these steps.

“Post installation tasks” on page 371

To get started using the SAN Volume Controller Console, complete these steps.

“Removing the SAN Volume Controller Console” on page 374

You can remove the IBM TotalStorage SAN Volume Controller Console from your Windows system.

#### Related information

“Installation overview for the SAN Volume Controller Console” on page 358

Before you install or upgrade and configure the IBM TotalStorage SAN Volume Controller Console on a Windows 2000 Server operating system, consider these prerequisites.

“SAN Volume Controller Console hardware installation requirements” on page 359

Before starting the installation, ensure that your system satisfies the following hardware installation prerequisites for installing the IBM TotalStorage SAN Volume Controller Console on a Windows 2000 Server operating system.

“SAN Volume Controller Console workstation space requirements” on page 360

Before starting the installation, ensure that your system satisfies the following workstation space prerequisites for installing the IBM TotalStorage SAN Volume Controller Console on a Windows 2000 Server operating system.

“SAN Volume Controller Console software installation requirements” on page 360

Before starting the installation, ensure that your system satisfies the following

software installation prerequisites for installing the IBM TotalStorage SAN Volume Controller Console on a Windows 2000 Server operating system.

## Installation overview for the SAN Volume Controller Console

Before you install or upgrade and configure the IBM TotalStorage SAN Volume Controller Console on a Windows 2000 Server operating system, consider these prerequisites.

You should have some knowledge of how to administer a Windows 2000 Server operating system. You should also become familiar with the command that you use during the installation or upgrade installation of the SAN Volume Controller Console.

You must be aware of the following list of installation and configuration tasks *before* you install or upgrade the SAN Volume Controller Console:

1. Check the hardware and software requirements.

Because the software is preinstalled, it is not normally necessary to replace the software on a node. However, if the software is lost for some reason, for example if the hard disk drive in the node fails, it is possible to copy all the software from another node connected to the same fibre-channel fabric. This process is known as node rescue.

If the SAN Volume Controller detects software errors an error code is generated. The additional data logged with the error will indicate the source of the software error. The additional data might look like this:

Assert File /build/lodestone/030129\_nd/src/user/vg/vgagentvt.c Line 1234

To view the additional data you will need to access the SAN Volume Controller web pages and select the Analyze error log option for the software error that you are investigating. Report the error code and the additional data to your IBM Product Support Center.

If this problem is known for your version of software, the customer will be advised to upgrade to the latest software level. If the problem is not known to the Support Center you might be asked to provide additional information for this error. In most cases a dump will automatically be taken when the software error is detected.

If requested to do so by your Support Center, you can use the SAN Volume Controller Console application on the master console to list and save dump data. If more than one dump file exists, select the dump file with a time stamp closest to the time stamp on the software error report and save this file for use by the Support Center.

2. If the SSH client software called PuTTY is not yet installed on your system, you must install the SSH client software. You can get more information about PuTTY from the PuTTY Web site home page:

<http://www.chiark.greenend.org.uk/~sgtatham/putty/>

and download PuTTY from the following Web site download page:

<http://www.chiark.greenend.org.uk/~sgtatham/putty/download.html>

**Note:** For your convenience the PuTTY installation program (putty-o.53b-installer.exe) is on the SAN Volume Controller Console installation CD-ROM in the SSHClient/PuTTY directory.

3. Install or upgrade the SAN Volume Controller Console either in graphical mode with the help of an installation wizard or in unattended mode (also known as silent mode), which involves customizing a response file and issuing a command.

Cluster software versions comprise a number of software components that are delivered as a single package. The size of the software update package depends on the number of components that are being replaced by that upgrade package. The software installation procedure involves copying the new software version to the cluster and then starting an automatic installation process. This installation process might take up to an hour to complete and during the process each of the nodes is restarted in turn. Once all the nodes in the cluster have been successfully restarted with the new software the new software version is automatically committed. While each node is being restarted there might be some degradation in the maximum input/output rate that can be sustained by the cluster.

4. Installation or upgrade installation operation. Because of the operational limitations that occur during the software upgrade process, the software installation is a customer task. The installation or upgrade installation operation can normally be performed concurrently with normal user I/O operations. If any restrictions apply to the operations that can be performed during the upgrade, then these restrictions will be documented on the SAN Volume Controller Web site from where the upgrade package was obtained. During the upgrade operation, only the SAN Volume Controller commands will be operational from the time the installation process starts to the time that the new software is committed or until the process has been backed-out. For a complete list of SAN Volume Controller commands, enter the following command: `svcinfo -?`
5. Verify the following Windows services associated with the SAN Volume Controller Console are installed and started:

- Service Location Protocol
- IBM CIM Object Manager - SVC
- IBM Websphere Application Server V5 - SVC

6. Get started using the SAN Volume Controller Console. Use a Web browser to access the SAN Volume Controller Console. You will identify the clusters to be managed to the SAN Volume Controller Console as well as complete the creation (initialization) of the SAN Volume Controller clusters.

To allow nodes to operate as a cluster, you must run all nodes at the same version of software. This rule is enforced by the cluster software itself. When you attempt to add a node to a cluster its software version is examined, and if it is not running the same version of the software as the other nodes in the cluster, the software revisions are automatically copied from one of the other nodes in the cluster before the add operation is completed. If for some reason it is not possible to update the software on the node that you are adding, the operation fails and the cluster logs an error to explain the cause of the failure.

7. Remove the SAN Volume Controller Console. You only need to perform this optional task if you get errors during installation verification.

#### **Related information**

“Installing or upgrading the IBM TotalStorage SAN Volume Controller Console for Windows” on page 357

## **SAN Volume Controller Console hardware installation requirements**

Before starting the installation, ensure that your system satisfies the following hardware installation prerequisites for installing the IBM TotalStorage SAN Volume Controller Console on a Windows 2000 Server operating system.

## Hardware prerequisites

The following hardware is required:

- Any Intel®-based PC running Windows 2000 Server SP 3
- Intel Pentium® processor at 1 GHz, or faster
- Support for a communications adapter
- CD-ROM drive
- Minimum 1 GB RAM recommended

### Related information

“Installing or upgrading the IBM TotalStorage SAN Volume Controller Console for Windows” on page 357

## SAN Volume Controller Console workstation space requirements

Before starting the installation, ensure that your system satisfies the following workstation space prerequisites for installing the IBM TotalStorage SAN Volume Controller Console on a Windows 2000 Server operating system.

### Workstation space

The following space on your workstation is required:

- 350 MB of disk space

**Note:** You might need to increase the total available disk space on your hard drives if the IBM TotalStorage SAN Volume Controller Console and other associated products are split between more than one logical drive. Also, the IBM TotalStorage SAN Volume Controller Console might require additional memory to operate if you configure it to manage many devices or devices with large configurations.

- Up to 65 MB of temporary disk space for installation purposes

### Related information

“Installing or upgrading the IBM TotalStorage SAN Volume Controller Console for Windows” on page 357

## SAN Volume Controller Console software installation requirements

Before starting the installation, ensure that your system satisfies the following software installation prerequisites for installing the IBM TotalStorage SAN Volume Controller Console on a Windows 2000 Server operating system.

### Software

The following software is required:

- Operating systems:
  - Windows 2000 Server SP3
- If the SSH client software called PuTTY is not yet installed on your system, you must install the SSH client software. You can get more information about PuTTY from the PuTTY Web site home page:

<http://www.chiark.greenend.org.uk/~sgtatham/putty/>

and download PuTTY from the following Web site download page:

<http://www.chiark.greenend.org.uk/~sgtatham/putty/download.html>

For your convenience the PuTTY installation program (putty-o.53b-installer.exe) is on the SAN Volume Controller Console installation CD-ROM in the SSHClient/PuTTY directory.

- IBM TotalStorage SAN Volume Controller Console. This is on the IBM TotalStorage SAN Volume Controller Console CD.
- Transmission Control Protocol/Internet Protocol (TCP/IP)
- Adobe Acrobat Reader version 4.0 or later (optional)

You need the Adobe Acrobat Reader to read License Agreement and product information from the SAN Volume Controller Console LaunchPad. You can download the Adobe Acrobat Reader from the following Web site:

– <http://www.adobe.com/support/downloads/main.html>

#### **Related information**

“Installing or upgrading the IBM TotalStorage SAN Volume Controller Console for Windows” on page 357

## **Installing or upgrading the SAN Volume Controller Console in graphical mode**

If you choose to install or upgrade the IBM TotalStorage SAN Volume Controller Console in unattended mode skip this section. You must satisfy all prerequisites before starting the installation.

1. Log onto your system as a local system administrator.
2. Insert the IBM TotalStorage SAN Volume Controller Console CD into the CD drive.

The IBM TotalStorage SAN Volume Controller Console program should start within 15 - 30 seconds if you have **autorun** mode set on your system. If the LaunchPad panel does not open, perform either one of the following steps:

- a. Use a Command Prompt to change to the W2K directory on the CD. Type:  
LaunchPad
- b. Using Windows Explorer, (**Start->Programs->Accessories->Windows Explorer**), go to the W2K directory located on the CD drive. Then double-click on the **LaunchPad.bat** file.

**Note:** If you are viewing the folder using the Windows Explorer with the option selected to *Hide file extensions for known file types*, find the LaunchPad file with the file type of MS-DOS Batch File.

3. The following options are displayed when the LaunchPad panel opens:

#### **SVC Console overview**

Offers information about the IBM TotalStorage SAN Volume Controller Console.

#### **Readme file**

Offers any last minute product information that did not make it into sections concerning the installation of the IBM TotalStorage SAN Volume Controller Console.

#### **Configuration guide**

Contains instructions about how to install the IBM TotalStorage SAN Volume Controller Console (a softcopy of this document).

**License agreement**

Offers information about the license for the IBM TotalStorage SAN Volume Controller Console.

**SAN Volume Controller Web site**

Offers information from the product Web site.

**Installation wizard**

Starts the IBM TotalStorage SAN Volume Controller Console installation program.

**Post installation tasks**

Details information about validating the installation, accessing the SAN Volume Controller Console URL and adding the SAN Volume Controller Console cluster to the SAN Volume Controller Console management facility.

**Exit** Exits the IBM TotalStorage SAN Volume Controller Console LaunchPad program.

- 4. Click **Readme file** from the LaunchPad panel or from the **README.txt** file located in the doc or W2K directory on the IBM TotalStorage SAN Volume Controller Console CD to check for information that might supersede the information in this guide.
- 5. Click **Installation wizard** from the LaunchPad panel to start the installation.

**Note:** The LaunchPad panel remains open behind the installation wizard so that you can access product information during the installation process. Click **Exit** if you want to close the LaunchPad.

- 6. There might be a slight delay while the software loads on your system. After the software loads a DOS prompt window opens to display the following message:

```

Initializing InstallShield Wizard...
Preparing Java <tm> Virtual Machine .....
.....
.....

```

- 7. The Welcome panel opens suggesting what documentation you should review prior to installation. Click **Next** to continue, or click **Cancel** to exit the installation.
- 8. The License Agreement panel opens. Read the license agreement information. Select **I accept the terms of the license agreement**, then click **Next** to accept the license agreement. Otherwise, keep the selection **I do not accept the terms of the license agreement** (it is the default) and click **Cancel** to exit the installation.
- 9. The installation wizard verifies that your workstation meets the installation requirements.
  - a. If you have a Service Location Protocol (SLP) service that is different from the SLP that the IBM TotalStorage SAN Volume Controller Console requires, the installation wizard displays an error and asks you to stop the installation and remove this SLP service from the system.
  - b. The installation wizard checks if the PuTTY SSH client is installed on your workstation.
  - c. The installation wizard determines whether this is a new installation, reinstallation or upgrade installation of the SAN Volume Controller Console. If the installation wizard determines that the SAN Volume Controller Console was previously installed on the system, it does a comparison of



the current version, release, modification, and fix code level with that of the code currently installed on the system. If the level is the same, this is a reinstallation. If the new code has a higher level, it is an upgrade. If the new code level is lower than the level on the system, the installation is invalid. In the case of reinstallation or upgrade installation, the installation wizard performs the following actions:

- 1) Checks if the Service Location Protocol (SLP), the IBM CIM Object Manager (CIMOM) service, and WebSphere Application Server V5 - SVC are started. If any of these services are started, the program asks if you want to continue the installation process by clicking **Next**. If you want to exit the installation program click **Cancel**. If you choose to continue, you must stop all the applications that use these services.
- 2) Presents a panel with the check-box option to Preserve Configuration. If you chose to preserve the existent Configuration, the installation program skips the next steps and goes directly to the Installation Confirmation panel discussed below.

10. The Destination Directory panel opens. Select one of the following options:

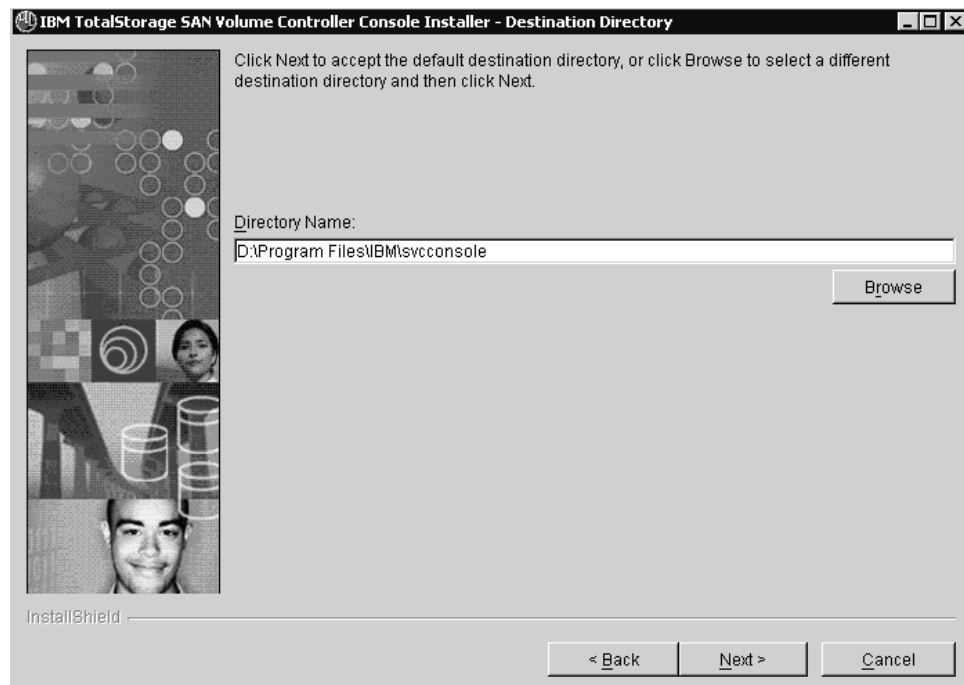

Figure 49. Destination Directory panel

- a. Click **Next** to accept the default directory.
- b. Click **Browse** to select a different directory for installation and then click **Next** to continue the installation process.
- c. Click **Cancel** to exit the installation process.

**Note:**

- a. The directory name, including the drive letter, must be a maximum of 44 characters.
- b. If the program detects insufficient space for the IBM TotalStorage SAN Volume Controller Console installation in the chosen destination, an error message is displayed. You can free some space on the destination drive and then click **Next** or you can stop

the installation program by clicking **Cancel**. You can also go back by clicking **Back**, and choosing another destination directory for the product.

11. The PuTTY configuration panel opens when the product space check is completed.

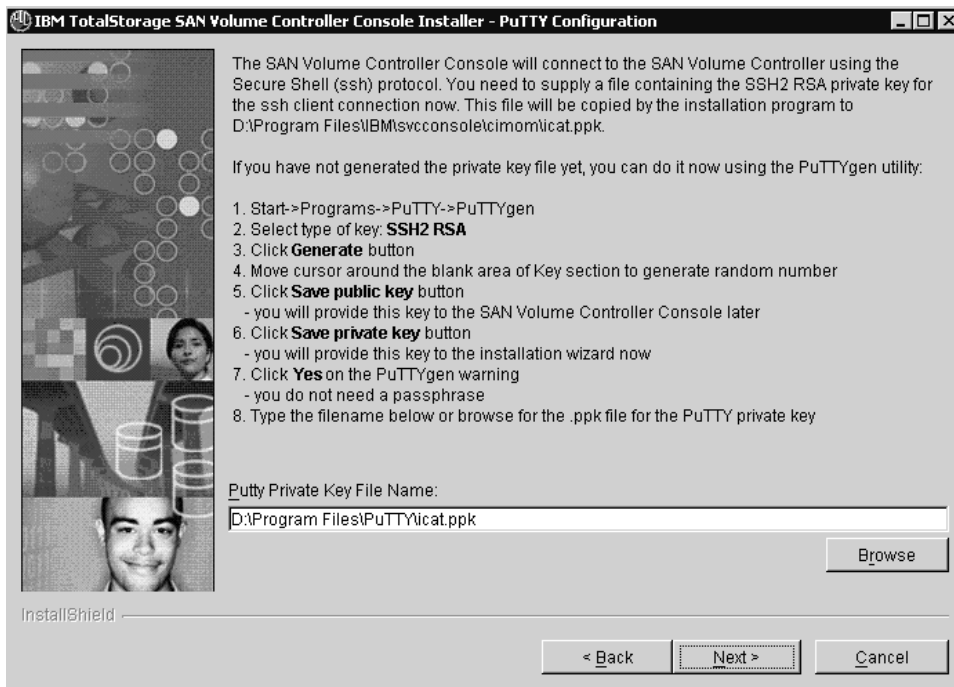

Figure 50. PuTTY Configuration panel

12. Enter the name and location on your system of your PuTTY SSH2 RSA private key file or click **Browse** to select the key file. If you have not prepared a PuTTY private key file yet, the steps on this panel tell you how to generate the PuTTY private and public key. Click **Next** to continue.
13. The Updating Embedded WAS Ports panel is displayed.

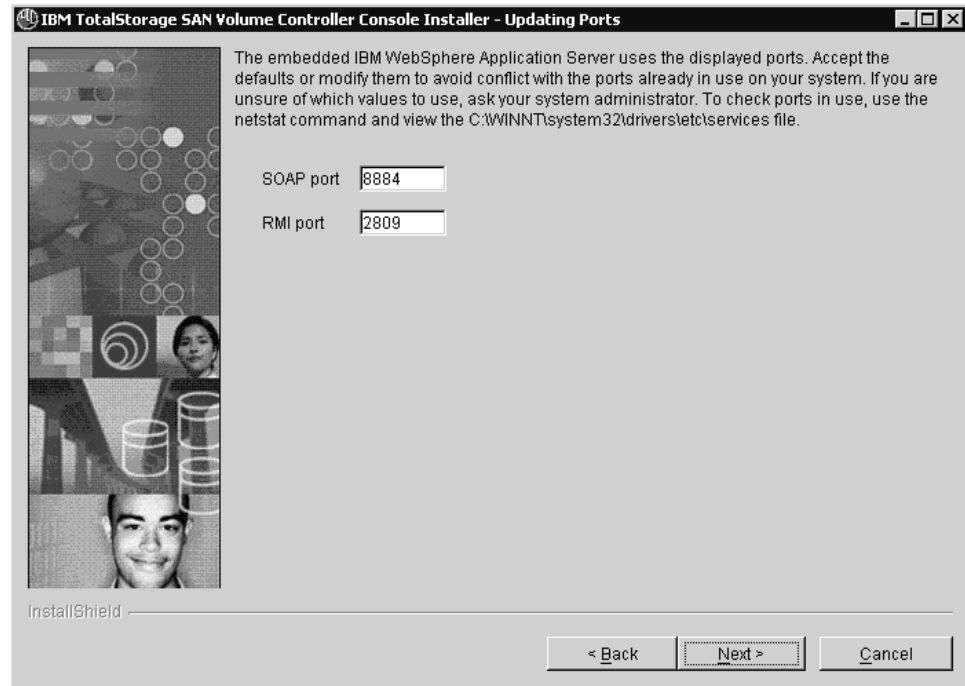

Figure 51. Updating Embedded WAS Ports panel

14. Update the default ports assignments by typing unique port numbers for the products that have been registered on your system. To check ports in use, use the **netstat -a** command and view the C:\WINNT\system32\drivers\etc\services file. Click **Next** to continue.
15. The Updating CIMOM ports panel is displayed. Update the default port assignments and the default communication protocol by typing the unique port numbers and choosing the desired communication protocol for the products that have been registered on your system. To check ports in use, use the **netstat -a** command and view the C:\WINNT\system32\drivers\etc\services file. Click **Next** to continue.
16. The Installation Confirmation panel opens. Click **Install** to confirm the installation location and file size and to start the final installation, reinstallation or upgrade installation. Click **Cancel** to exit the installation wizard or click **Back** to go to the previous panel.
17. The Installation Progress panel opens indicating how much of the installation has been completed. Installation usually takes 3 - 10 minutes depending on the configuration of your workstation.

**Note:** If you click **Cancel** a popup panel opens asking you to confirm the cancellation of the installation wizard: Cancel the current operation?. You may confirm the cancellation by clicking **Yes** or continue the installation by selecting **No**. If you confirm the cancellation, the information you entered or selected in the previous panel is not saved. You must start the installation again from the beginning.

After the completion of the successful installation of the IBM TotalStorage SAN Volume Controller Console, the installer attempts to start the following services:

- Service Location Protocol
- The IBM CIM Object Manager

- The IBM WebSphere Application Server V5 - SVC
18. When the Installation Progress panel closes, the Finish panel opens. Before proceeding, you might want to review the log file for any possible error messages. The log file is located in xxx\logs\install.log, where xxx is the destination directory where the IBM TotalStorage SAN Volume Controller Console for Windows was installed. The install.log contains a trace of the installation actions.
 

**Note:** At the bottom of the Finish panel is a checkbox labeled **View post installation tasks**. If you check this box and then click **Finish**, the wizard will exit and the post installation tasks text file is displayed. The LaunchPad panel Post installation tasks link also displays this same text file. You can avoid the display of the text file by unchecking the **View post installation tasks** box before you click the **Finish** button.
  19. Click **Finish** to exit the installation wizard.
 

**Note:** Ordinarily, you do not need to restart your system during or after the installation of the IBM TotalStorage SAN Volume Controller Console. However, the installation wizard might determine that a restart is necessary. Restart your system if required. After you restart the system, the installation wizard continues with the installation.
  20. If you have not yet reviewed the post-installation tasks from the installation Finish panel, review the post installation tasks from the LaunchPad program.
    - a. Click **Post installation tasks** on the LaunchPad panel which opens the same file available from the Installation Finish panel.
    - b. Continue with the post-installation tasks for the SAN Volume Controller by following the instructions in this file.
  21. Exit the LaunchPad program by clicking **Exit** on the LaunchPad panel.
  22. Verify that the Windows services associated with your SAN Volume Controller Console are correctly installed and started.

**Related information**

“Installing or upgrading the IBM TotalStorage SAN Volume Controller Console for Windows” on page 357

## Installing or upgrading the SAN Volume Controller Console in unattended (silent) mode

The unattended (silent) mode install or upgrade option enables you to run the installation or upgrade installation unattended.

Use this method of installation to customize a response file and issue a command from a command prompt window. The response file is a template on the IBM TotalStorage SAN Volume Controller CD. You can also create a standard response file to ensure that the product is installed consistently on multiple systems. You must satisfy all prerequisites before starting the installation.

The installation wizard determines whether this is a reinstallation or upgrade of the SAN Volume Controller. If the installation wizard determines that the SAN Volume Controller was previously installed on the system, it does a comparison of the current version, release, modification, and fix code level with that of the code currently installed on the system. If the level is the same, this is a reinstallation. If the new code has a higher level, it is an upgrade. If the new code level is lower than the level on the system, the installation is invalid.

1. Log on to the system as a local system administrator.

2. Insert the IBM TotalStorage SAN Volume Controller Console CD into the CD drive.
3. If you have autorun mode set on your system, the IBM TotalStorage SAN Volume Controller Console program will start within 15-30 seconds. Click **Exit** from the LaunchPad.
4. Locate the response file named, responsefile, on your IBM TotalStorage SAN Volume Controller Console CD in the W2K directory.
5. Using Windows Explore or a command prompt, copy the response file to your hard drive.
6. The SAN Volume Controller Console will connect to the SAN Volume Controller using the Secure Shell (SSH) protocol. You need to supply a file containing the SSH2 RSA private key for the SSH client connection. This file will be copied by the installation program to <inst\_dir>\cimom\icat.ppk, for example C:\ProgramFiles\IBM\svconconsole\cimom\icat.ppk. If you have not generated the private key file before, you can do it now using the PuTTYgen utility. To generate the private key using the PuTTYgen utility, perform the following steps:
  - a. Click **Start -> Programs -> PuTTY -> PuTTYgen**.
  - b. Select the type of key: **SSH RSA**.
  - c. Click **Generate**.
  - d. Move the cursor around the blank area of the Key section to generate a random number.
  - e. Click **Save public key**. You will provide this key to the SAN Volume Controller Console later.
  - f. Click **Save private key**. You will provide this key to the installation wizard using the option below in the response file.
  - g. Click **Yes** on the PuTTYgen warning. You do not need a passphrase.
  - h. Ensure that you set the value of the <-W puttyConfiguration.puttyPrivateKeyFile> option in the response file, to the name of the file containing the PuTTY private key.
7. Using a text editor modify the default options in the response file with the values you want to supply to the installation program:
  - a. Remove the # character from the beginning of a line if you do not want to use the default value. Change the default value to the value that you want for that option. You *must* enclose all values in double quotation marks ("").
  - b. Depending on whether you are doing a new installation, reinstallation or upgrade, certain response file lines must be active as detailed below. If a response file line is active but inappropriate to the mode (new, reinstall or upgrade) it will be ignored.

#### **New Installation:**

- The <-P *product.installLocation*> option defines the default directory where the product is to be installed. To specify a destination directory other than the default, remove the # character from the corresponding line and replace the default directory with the desired directory.
- The <-G *checkPrerequisite*> option checks the prerequisites. If you want to disable this option, remove the # character from the corresponding line and change the value of the option to no.
- Change the default ports values for the embedded WebSphere Application Server - V5 SVC using the update ports variables options. If you want to change a specific port used for a particular WebSphere service, remove the

# character from the beginning of the line containing the value of the option and set it to the value you desire. The following are the embedded WebSphere ports options:

- <-W ports.portSOAP="8884">
  - <-W ports.portRMI="2809">
  - <-W ports.portHTTP="9080">
  - <-W ports.portHTTPS="9443">
- Change the default ports values and default server communication type for the IBM CIM Object Manager server using variables options below. If you want to change a specific port or the default server communication type, remove the # character from the beginning of the line containing the option's value and set it to the value you desire. The following are the CIM Object Manager server options:
    - <-W cimObjectManagerPorts.port="5989">
    - <-W cimObjectManagerPorts.indicationPort="5990">
    - <-W cimObjectManagerPorts.serverCommunication="HTTPS">
  - The <-W puttyConfiguration.puttyPrivateKeyFile> options specifies the name and location of the PuTTY private key file that the SAN Volume Controller Console software should use to connect to the SAN Volume Controller clusters. Remove the # character from the corresponding line and add the fully qualified location of the PuTTY private key file. Save the responsefile *without* a file extension such as .txt.

#### Reinstallation or Upgrade:

- The <-G startUpgrade> option must be enabled to permit the new SAN Volume Controller Console to be reinstalled (having the same version) or upgraded (installed at a higher version). Enable this option by removing the # character from the corresponding line and changing the value of the option to yes.
- The <-G stopProcessesResponse> option tells the install program whether or not to automatically stop SLP, IBM CIM Object Manager (CIMOM), and WebSphere Application Server - V5 SAN Volume Controller services when reinstalling or upgrading the product. By default, this option is set to no. If you do not change this default value, the reinstallation or upgrade stops when these services are running. If you want to automatically stop the SLP and IBM CIM Object Manager (CIMOM), remove the # character from the corresponding line and change its value to yes.
- The <-G saveConfiguration> option specifies whether or not to save the configuration files when reinstalling or upgrading the product. If you do not want to save the configuration files when reinstalling or upgrading, remove the # character from the corresponding line and change the value of the option to no. If you do not choose to save the configuration, you will have to make the following active or accept the default values.
  - Change the default ports values for the embedded WebSphere Application Server - V5 SAN Volume Controller using the update ports variables options. If you want to change a specific port used for a particular WebSphere service, remove the # character from the beginning of the line containing the value of the option and set it to the value you desire. The following are the embedded WebSphere ports options:
    - <-W ports.portSOAP="8884">
    - <-W ports.portRMI="2809">
    - <-W ports.portHTTP="9080">

- <-W ports.portHTTPS="9443">
  - Change the default ports values and the default server communication type for the CIM Object Manager server using variables options below. If you want to change a specific port or the default server communication type, remove the # character from the beginning of the line containing the option's value and set it to the value you desire. The following are the CIM Object Manager server options:
    - <-W cimObjectManagerPorts.port="5989">
    - <-W cimObjectManagerPorts.indicationPort="5990">
    - <-W cimObjectManagerPorts.serverCommunication="HTTPS">
  - The <-W *puttyConfiguration.puttyPrivateKeyFile*> options specifies the name and location of the PuTTY private key file that the SAN Volume Controller Console software should use to connect to the SAN Volume Controller clusters. Remove the # character from the corresponding line and add the fully qualified location of the PuTTY private key file. Save the response file without a file extension such as .txt.
8. From a command prompt window, type the following command:
- a. <CD drive path>\W2K\install -options <response file path>\responsefile
- where <CD drive path> is the path of your CD drive. <response file path> is the path of the responsefile file that you copied in step 5 on page 367 and customized in step 7 on page 367.
- Note:** The directory name, including the drive letter, must be a maximum of 44 characters.
9. During the installation, dotted lines are displayed across the screen. When the installation program ends, control returns to the Command Prompt.
10. Check for installation errors in the install.log file. This file is initially created in the system temporary file under the subdirectory named, cimagent. After all the prerequisites checks have been performed, the log file is copied to the <dest-path>\logs directory. The following is an example of an install.log file:

```

(May 15, 2003 9:36:06 AM), This summary log is an overview of the
sequence of the installation of the IBM TotalStorage SAN Volume
Controller Console 1.0.0.12
(May 15, 2003 9:38:22 AM), IBM TotalStorage SAN Volume Controller
Console installation process started with the following install
parameters:
Target Directory: C:\Program Files\IBM\svconconsole
SOAP port: 8884
RMI port: 2809
(May 15, 2003 9:38:28 AM), Copying Service Location Protocol Files ...
(May 15, 2003 9:38:29 AM), Service Location Protocol successfully installed
(May 15, 2003 9:38:29 AM), Copying CIM Object Manager Files ...
(May 15, 2003 9:39:26 AM), The PuTTY private key successfully copied
into file C:\Program Files\IBM\svconconsole\cimom\icat.ppk
(May 15, 2003 9:39:51 AM), The file setupCmdLine.bat successfully updated.
(May 15, 2003 9:39:51 AM), Compile MOF files started ...
(May 15, 2003 9:40:06 AM), MOF files successfully compiled.
(May 15, 2003 9:40:06 AM), Generate a certificate store started ...
(May 15, 2003 9:40:19 AM), Certificate store called truststore
successfully generated.
(May 15, 2003 9:40:20 AM), IBM CIM Object Manager successfully installed
(May 15, 2003 9:40:20 AM), Installing embedded version of IBM WebSphere
Application Server ...
(May 15, 2003 9:41:42 AM), Websphere Application Server - SVC
successfully installed.
(May 15, 2003 9:43:20 AM), Copying SAN Volume Controller Console Ear Files...
(May 15, 2003 9:46:11 AM), The ICAConsole application successfully installed.
(May 15, 2003 9:47:24 AM), The SVCConsole application successfully installed.
(May 15, 2003 9:48:06 AM), The help application successfully installed.
(May 15, 2003 9:48:27 AM), The ""C:\Program Files\IBM\svconconsole\console\
embeddedWAS\bin\expressPorts\UpdateExpressMultiPorts.bat" -soap 8884
-boot 2809 -remove" command updated successfully embedded WAS ports
in configuration files.
(May 15, 2003 9:48:27 AM), Command to be executed : net start cimomsrv
(May 15, 2003 9:48:49 AM), Command to be executed : net start
"IBMWAS5Service - SVC"
(May 15, 2003 9:50:15 AM), The following services started successfully:
Service Location Protocol
IBM CIM Object Manager
IBM WebSphere Application Server V5 - SVC
(May 15, 2003 9:50:15 AM), INSTSUCC: The IBM TotalStorage SAN Volume
Controller Console has been successfully installed.

```

11. Close the command prompt window by entering a command, for example **exit**.
12. After the completion of the successful installation of the IBM TotalStorage SAN Volume Controller Console, the installer attempts to start the following services:
  - a. Service Location Protocol
  - b. The IBM CIM Object Manager
  - c. IBM WebSphere Application Server V5 - SVC
13. Continue with the post installation tasks for the IBM TotalStorage SAN Volume Controller Console using the instructions in the following section. You can also view the post installation tasks using the following option:
  - a. From a Command Prompt, change directory into the W2K directory on the CD drive. Open the LaunchPad by typing:

LaunchPad
  - b. Click **Post installation tasks** on the LaunchPad window. Continue with the post installation tasks for the IBM TotalStorage SAN Volume Controller Console by following the instructions in this file.
14. Verify that the Windows services associated with your SAN Volume Controller Console are correctly installed and started.

#### Related information



“Installing or upgrading the IBM TotalStorage SAN Volume Controller Console for Windows” on page 357

## Verifying the Windows services associated with the SAN Volume Controller Console

To verify that the Windows services associated with your IBM TotalStorage SAN Volume Controller Console are correctly installed and started, complete these steps.

Perform the following steps to verify your Service Location Protocol (SLP), IBM CIM Object Manager (CIMOM), and IBM WebSphere Application Server V5 - SVC services were correctly installed

1. Verify the installation of the Service Location Protocol (SLP).
  - a. Verify that the Service Location Protocol is started. Select **Start -> Settings -> Control Panel**. Double-click the **Administrative Tools** icon. Double-click the **Services** icon.
  - b. Find **Service Location Protocol** in the **Services** list. For this component, the **Status** column should be marked Started.
  - c. If the Service Location Protocol is not started, right-click on **Service Location Protocol** and select **Start** from the pop-up menu. Wait for the **Status** column to change to Started.
  - d. Do not close the Services window because you will also use it to verify the CIM Object Manager (CIMOM) service.
2. Verify the installation of the SAN Volume Controller Console.
  - a. Find the **IBM CIM Object Manager - SVC** in the **Services** list. For this component, the **Status** column should be marked Started.
  - b. If the IBM CIM Object Manager is not started, right click on **IBM CIM Object Manager - SVC** and select **Start** from the pop-up menu. Wait for the **Status** column to change to Started.
  - c. Do not close the Services window because you will also use it to verify the IBM WebSphere Application Server V5 - SVC service.
3. Verify the installation of the IBM WebSphere Application Server V5 - SVC service.
  - a. Find the **IBM WebSphere Application Server V5 - SVC** in the **Services** list. For this component, the **Status** column should be marked Started.
  - b. If the **IBM WebSphere Application Server V5 - SVC** service is not started, right click on **IBM WebSphere Application Server V5 - SVC** and select **Start** from the pop-up menu. Wait for the **Status** column to change to Started.
  - c. Close the Services window.
  - d. Close the Administrative Tools window.

### Related information

“Installing or upgrading the IBM TotalStorage SAN Volume Controller Console for Windows” on page 357

## Post installation tasks

To get started using the SAN Volume Controller Console, complete these steps.

Once you have installed the IBM TotalStorage SAN Volume Controller and the services (IBM CIM Object Manager, IBM WebSphere Application Server V5 - SVC, Service Location Protocol) have started, you will use a browser to access the Web

pages of the Console for purposes of administering the SAN Volume Controller as well as configuring SAN Volume Controller clusters.

Each time you wish to add a SAN Volume Controller cluster to the collection of clusters managed by the IBM TotalStorage SAN Volume Controller, you must store the PuTTY SSH client public key which is located on the SAN Volume Controller system on the SAN Volume Controller cluster.

**Attention:** If you do not store the SSH public key on the SAN Volume Controller cluster, the SAN Volume Controller Console software cannot connect to the cluster.

When you installed the SAN Volume Controller Console, you provided the name and location of the PuTTY SSH client private key. At the time you used PuTTYGen to generate the PuTTY SSH private key, you also generated an SSH public key. Familiarize yourself with the name and location of the PuTTY SSH public key on the SAN Volume Controller Console system.

**Note:** This is a long term administrative task and not just a post-installation task.

To enter config mode:

```
switch#config-t
```

To enable ssh:

```
switch (config)#ssh server enable
```

This document has an overview of the steps necessary to get to the web page where you identify the PuTTY public key to the clusters. These steps are documented in more detail in other sections of this manual and references are included to the relevant section titles.

1. Start your Web browser to access the SAN Volume Controller Console. It is recommended that you log onto the SAN Volume Controller Console system from a browser on which the SAN Volume Controller Console is installed to complete uploading the client public SSH key for each cluster that you want to manage. You can access the SAN Volume Controller Console by typing the following:

```
http://localhost:9080/ica
```

**Note:** 9080 is the default HTTP port. If a different port number for HTTP was assigned during the installation process, then you must substitute that port number in the URL.

2. Log onto the SAN Volume Controller Console using the default super user name and password. The default super user name is superuser and the default super user password is passwd. The first time you log onto the SAN Volume Controller Console using the default super user name and password, you will be prompted to change the default password.
3. Access user assistance. This is an optional step.

You can access help for the specific task on which you are working by clicking the small information icon just below the banner in the upper right section of the Web page. The help assistant panel opens on the right-hand side of the page.

You can also launch a separate user assistance panel by clicking the small question mark icon just below the banner in the upper right section of the Web page. A secondary browser window opens which has icons in the frame labeled **Contents** for you to select to make extensive user assistance information available to you.

4. Identify the SAN Volume Controller clusters to the SAN Volume Controller Console. The steps you might need to perform to add SAN Volume Controller clusters to the SAN Volume Controller Console collection of managed clusters, depends on the current status of the cluster in which you are interested.

Choose one of the following two steps, depending on whether the cluster has completed the cluster creation (initialization) process:

- a. Uninitialized SAN Volume Controller cluster.

If you have not yet created a SAN Volume Controller cluster using the front panel of the SAN Volume Controller cluster, you will need to perform that phase of the cluster creation first. You will be given a special password by the customer engineer (CE) to be used in later steps of initializing the SAN Volume Controller Console.

After you create the SAN Volume Controller cluster using the front panel of cluster, you will need to complete the creation of the cluster by using the SAN Volume Controller Console Web pages.

Enter the IP address of the cluster and check **Create (Initialize) Cluster**. When you click the **OK** button, the Create a Cluster wizard will take over and present you with the panels you need to complete initializing the cluster. The browser will then prompt you to enter the network password. Enter the user name admin and the password provided to you by the customer engineer (CE) during the cluster front panel creation phase which is configured for the cluster.

During the initializing of the cluster, using the SAN Volume Controller Console, you will be taken to a Web page to provide the PuTTY SSH client public key to upload the key to the cluster. Step 5 below continues with the SSH public key input description. This PuTTY SSH client public key is the other key of the key pair you provided to the SAN Volume Controller Console during the installation program.

- b. Previously initialized SAN Volume Controller cluster.

If the SAN Volume Controller cluster has completed the initialization (creation) process but is not yet registered with the SAN Volume Controller Console, click the **Add SAN Volume Controller Cluster** button and then add the cluster IP address but *do not* check **Create (Initialize) Cluster**, which is above the **OK** button. When you click the **OK** button, you will be taken to the Web page to provide the PuTTY SSH client public key to upload to the cluster. Step 5 below continues with the SSH key input description.

The browser will then prompt you to enter the network password. Enter the user name admin and the password which is configured for the cluster. Then Click **OK**.

5. Store the SAN Volume Controller Console system SSH public key on the SAN Volume Controller Console. This PuTTY client SSH public key is the other key in the key pair you provided to the SAN Volume Controller Console during the installation program. Each key is associated with an ID string that you define that can consist of up to 30 characters. Up to 100 keys can be stored on a cluster. You can add keys to provide either *administrator* access or *service* access. Perform the following steps to store the SSH public key on the cluster:
  - a. Enter the SSH public key name and directory location on your local browser system in the field labeled **Public Key (file upload)** or click **Browse** to identify the key on the local system. Alternatively, you can paste the SSH key into the **Public Key (direct input)** field.
  - b. Enter an ID string in the field labeled **ID**. This is a unique ID to distinguish the key and is not related to a user name.

- c. Select the *administrator* **Access Level** radio button.
  - d. Click **Add Key** to store this SSH public key on the cluster.
6. Launch the secondary Web browser window to manage your specific cluster. Once you have identified the SAN Volume Controller clusters to the SAN Volume Controller Console you can see a summary of all of the clusters. From this point, you can select the specific cluster in which you are interested and then launch the browser window specifically for the cluster. Perform the following steps to launch the browser window:
- a. Click **Clusters** in the portfolio section of your browser window in the left-hand frame. A new view will be displayed in the work area.
  - b. Check the small box in the Select column left of the cluster in which you are interested to select that cluster. Select **Launch the SAN Volume Controller application** in the drop down list of the work area and click **Go**. A secondary browser window opens to the SAN Volume Controller Web application. Now you can work with the specific SAN Volume Controller cluster which you selected.

**Note:** The ClusterName parameter in the browser location URL, identifies the cluster with which you are working.

For example:

```
http://9.43.147.38:9080/svc/Console?Console.login
Token=79334064:f46d035f31:-7ff1&Console.
ClusterName=9.43.225.208
```

Select **Manage Cluster** and click **View Cluster Properties** in the portfolio section.

This completes the verification of the connection to the SAN Volume Controller.

#### **Related information**

“Installing or upgrading the IBM TotalStorage SAN Volume Controller Console for Windows” on page 357

## **Removing the SAN Volume Controller Console**

You can remove the IBM TotalStorage SAN Volume Controller Console from your Windows system.

1. Log onto the system as a local system administrator.
2. Stop the IBM CIM Object Manager (CIMOM), IBM WebSphere Application Server V5 - SVC, and the Service Location Protocol (SLP) services if they are started.
  - a. Click **Start -> Settings -> Control Panel**. In the Control Panel window, double-click on the **Administrative Tools** icon and then double-click the **Services** icon. The Services window opens.
  - b. Stop the IBM CIM Object Manager (CIMOM) service:
    - 1) In the Services window, scroll to IBM CIM Object Manager (CIMOM). Click on the service to select it.
    - 2) If the **Status** column shows Started, right-click the service, then click **Stop** on the menu.
  - c. Stop the IBM WebSphere Application Server V5 - SVC service:
    - 1) In the Services window, scroll to IBM WebSphere Application Server V5 - SVC. Click on the service to select it.

- 2) If the **Status** column shows Started, right-click the service, then click **Stop** on the menu.
- 3) Wait for the service to stop.
- d. Stop the Service Location Protocol (SLP) service:

**Note:** You must be careful if you have other applications that use the Service Location Protocol (SLP) service. In this case, you must stop these applications before stopping Service Location Protocol (SLP) service, because during the removal process the Service Location Protocol (SLP) service will be deleted. You must also stop the configuration utilities for the IBM TotalStorage SAN Volume Controller Console, if they are running.

- 1) In the Services window, scroll to Service Location Protocol. Click on this service to select it.
- 2) If it is running (the **Status** column shows Started), right-click the service, then click **Stop** on the menu.  
(If you did not stop the IBM CIM Object Manager (CIMOM) service, the system now asks if you want to stop the IBM CIM Object Manager (CIMOM) . Because the IBM CIM Object Manager (CIMOM) service is dependent on the Service Location Protocol service which you just stopped, you must click **Yes** to stop the IBM CIM Object Manager (CIMOM).)
- 3) Wait for the services to stop.
- 4) Close the Services window.
- 5) Close the Administrative Tools window.
3. Use the Windows Add/Remove Programs facility to remove the IBM TotalStorage SAN Volume Controller Console and the Service Location Protocol components.
  - a. From the Windows menu bar, click **Start -> Settings -> Control Panel**. Double-click **Add/Remove Programs**.
  - b. Click **IBM TotalStorage SAN Volume Controller Console** from the list of currently installed programs and click **Remove** to remove the product.
4. The Welcome panel for the Uninstaller opens. Click **Next** to continue or click **Cancel** to stop the removal of the IBM TotalStorage SAN Volume Controller Console.
5. The program detects whether the Service Location Protocol, IBM CIM Object Manager (CIMOM), and the IBM WebSphere Application Server V5 - SVC services are running.
  - a. If any of these services are found to be running, the uninstaller will stop these services before proceeding with the uninstallation. You should consider at this point whether applications other than the IBM TotalStorage SAN Volume Controller Console are dependent on the services. You can either:
    - Click **Next** to have the program stop the services for you.
    - Click **Cancel** to exit the removal process if you wish to manually stop the services and any dependent applications. Instructions for stopping the services are described in step 2 on page 374. You must then restart the removal process from the Windows Add/Remove facility.
6. The Confirmation panel opens. Click **Remove** to continue or click **Cancel** to stop the removal of the IBM TotalStorage SAN Volume Controller Console. Click **Back** to return to the previous panel.

7. The Uninstallation Progress panel opens. Wait for the program to remove the IBM TotalStorage SAN Volume Controller Console product.
8. The Finish panel for the Uninstaller opens. This panel indicates the result of the removal process (successful or failed). Click **Finish** to complete the removal process and exit the wizard.

**Note:** If the Uninstaller could not remove some information from the system, you will see a **Next** button instead of a **Finish** button. Click **Next** to open the Reboot panel. If the reboot panel opens, you can choose to either restart your computer now or restart your computer at a later time. Then click **Finish** to complete the removal process and exit the wizard.

9. Close the Add/Remove Programs window.

Perform the following steps to complete the removal process:

1. If the system has not been restarted since IBM TotalStorage SAN Volume Controller Console was removed, do so now.
2. Log onto the system as a local system administrator.
3. The removal process saves files uniquely related to the configuration in a backup directory under the destination path where you installed the IBM TotalStorage SAN Volume Controller Console. You may want those files if you intend to reinstall the product. Otherwise you can remove the backup folder and files. An example of the default destination path is: C:\Program Files\IBM\svccconsole.
4. Perform other cleanup tasks:
  - Empty your Windows Recycle Bin to reclaim the disk space that was made available during the removal process.

**Related information**

“Installing or upgrading the IBM TotalStorage SAN Volume Controller Console for Windows” on page 357

## Valid combinations of FlashCopy and Remote Copy functions

The following table outlines the combinations of FlashCopy and Remote Copy functions that are valid for a single virtual disk (VDisk).

*Table 56. Valid combinations of FlashCopy and Remote Copy interactions*

FlashCopy	Remote Copy Primary	Remote Copy Secondary
FlashCopy source	Supported	Supported
FlashCopy target	Not supported	Not supported

## Setting up SNMP traps

You can set up SNMP traps if the master console has been installed on a separate machine.

**Prerequisites**

There are two steps required to enable the Call-Home process:

1. Set up the SAN Volume Controller SNMP Trap destination, a specific machine (IP Address)
2. Set up IBM Director to send a correctly formatted e-mail

## Overview

To set up the SAN Volume Controller SNMP trap destination, the destination is normally set up as part of the SAN Volume Controller Installation process, but can also be done through the SAN Volume Controller Web pages, by using a browser to log on to the SAN Volume Controller cluster and selecting the option Error notification. See *IBM TotalStorage SAN Volume Controller: Installation Guide* for more information.

---

## Configuring IBM Director overview

You can configure IBM Director for Call-Home and e-mail if it has been installed on a separate machine or is reinstalled on the master console.

1. Set up an Event Action Plan
2. Set up a correctly formatted e-mail

### Related tasks

“Setting up an event action plan”

You can set up event action plans if the IBM Director has been installed on a separate machine or is reinstalled on the master console.

“Setting up an e-mail” on page 378

You can set up the e-mails if the IBM Director has been installed on a separate machine or is reinstalled on the master console.

“Setting up an e-mail user notification” on page 379

You can set up the e-mails if the IBM Director has been installed on a separate machine or is reinstalled on the master console.

## Setting up an event action plan

You can set up event action plans if the IBM Director has been installed on a separate machine or is reinstalled on the master console.

In order for IBM Director to present the correct SAN Volume Controller information to enable an action plan to be configured, it has to have received a trap from the SAN Volume Controller.

1. Create a SAN Volume Controller trap by removing the ac power from one of the uninterruptible power supply units that are supplying the cluster. Replace the power after 30 seconds.
2. Click **Event Log (ALL)** from the IBM Director Console and check that the trap from the SAN Volume Controller has been received.
3. Click **Tasks → Event Action Plan Builder** from the IBM Director Console.
4. Right-click **Simple Event Filter**.
5. Click **New**.
6. Click the **Event type** tab from the Simple Event Filter Builder window.
7. Clear the **Any** check box.
8. In the list, select the following items in this sequence:
  - a. SNMP
  - b. 1 (iso)
  - c. 2 (org)
  - d. 6 (dod)
  - e. 1 (internet)
  - f. 4 (private)

- g. 1 (enterprise)
  - h. 2 (ibm)
  - i. 6 (ibmprod)
  - j. 190
  - k. 1
9. Click the **Category** tab.
  10. Clear the **Any** check box.
  11. Click **Alert**.
  12. On the menu bar, click **File** and save the file with the name 2145 Error.
  13. From the Event Filter List, select the newly created **2145 Error** filter, and drag and drop it on to the **Log All Events** icon in the Event Action Plan column. This action causes the **2145 Error** filter to be called upon when any event is logged.
  14. Perform steps 4 through 11 again (do not do step 8k). On the menu bar, click **File** and save the file with the name 2145 Event.
  15. From the Event Filter List, select the newly created **2145 Event** filter, and drag and drop it on to the **Log All Events** icon in the Event Action Plan column. This action causes the **2145 Event** filter to be called upon when any event is logged.

#### **Related tasks**

“Configuring IBM Director overview” on page 377

You can configure IBM Director for Call-Home and e-mail if it has been installed on a separate machine or is reinstalled on the master console.

## **Setting up an e-mail**

You can set up the e-mails if the IBM Director has been installed on a separate machine or is reinstalled on the master console.

1. From the IBM Director Console menu bar, select **Tasks -> Event Action Plan Builder**.
2. In the **Actions** column, right-click on **Send an Internet (SMTP) E-mail** and select **Customize**.
3. In the resulting **Customize Action: Send an Internet (SMTP) E-mail** panel fill-in:

#### **Internet E-mail Address**

- Enter the IBM Retain E-mail address
  - CALLHOME1@de.ibm.com for USA customer’s
  - CALLHOME0@de.ibm.com for customer’s outside of the USA.

#### **Reply to**

- Enter the E-mail address that you require any replies to be directed

#### **SMTP E-mail Server**

- Enter the address of your E-mail server

#### **SMTP Port**

- Change this, if required to your SMTP Server port number

#### **Subject of E-mail Message**

- Fill in 2145 Error Notification.

#### **Body of the E-mail Message**

- Fill in the following information:
  - Contact name.....not required in the E-mail to Admin



**Note:** There is a limitation of 72 characters per field.

- Contact phone number.....not required in the E-mail to Admin
- Offshift phone number.....not required in the E-mail to Admin
- Machine location
- Record Type = 1

&iso.org.dod.internet.private.enterprises.ibm.ibmProd.190.4.1  
&iso.org.dod.internet.private.enterprises.ibm.ibmProd.190.4.2  
&iso.org.dod.internet.private.enterprises.ibm.ibmProd.190.4.3  
&iso.org.dod.internet.private.enterprises.ibm.ibmProd.190.4.4  
&iso.org.dod.internet.private.enterprises.ibm.ibmProd.190.4.5  
&iso.org.dod.internet.private.enterprises.ibm.ibmProd.190.4.6  
&iso.org.dod.internet.private.enterprises.ibm.ibmProd.190.4.7  
&iso.org.dod.internet.private.enterprises.ibm.ibmProd.190.4.8  
&iso.org.dod.internet.private.enterprises.ibm.ibmProd.190.4.9  
&iso.org.dod.internet.private.enterprises.ibm.ibmProd.190.4.10  
&iso.org.dod.internet.private.enterprises.ibm.ibmProd.190.4.11  
&iso.org.dod.internet.private.enterprises.ibm.ibmProd.190.4.12

4. Click **Save** to save the information, using the name **2145CallHome**.
5. From the **Send an Internet (SMTP) E-mail** list select the newly created **2145CallHome** E-mail and Drag and Drop it on to the **2145 Error** action plan icon in the **Event Action Plan** column. This action causes the **2145CallHome** to be call when the **2145 Error** filter is satisfied.

#### **Related tasks**

“Configuring IBM Director overview” on page 377

You can configure IBM Director for Call-Home and e-mail if it has been installed on a separate machine or is reinstalled on the master console.

## **Setting up an e-mail user notification**

You can set up the e-mails if the IBM Director has been installed on a separate machine or is reinstalled on the master console.

1. From the IBM Director Console menu bar, select **Tasks** → **Event Action Plan Builder**.
2. In the **Actions** column, right-click on **Send an Internet (SMTP) E-mail** and select **Customize**.
3. In the resulting **Customize Action: Send an Internet (SMTP) E-mail** panel fill-in :

#### **Internet E-mail Address**

- Enter the E-mail address you require for notification

#### **Reply to**

- Enter the E-mail address that you require any replies to be directed

#### **SMTP E-mail Server**

- Enter the address of your E-mail server

#### **SMTP Port**

- Change this, if required to your SMTP Server port number

#### **Subject of E-mail Message**

- Fill in 2145 Error Notification.

#### **Body of the E-mail Message**

- Fill in the following information:

- # Machine location = xxxx

```
iso.org.dod.internet.private.enterprises.ibm.ibmProd.190.4.1
iso.org.dod.internet.private.enterprises.ibm.ibmProd.190.4.2
iso.org.dod.internet.private.enterprises.ibm.ibmProd.190.4.3
iso.org.dod.internet.private.enterprises.ibm.ibmProd.190.4.4
iso.org.dod.internet.private.enterprises.ibm.ibmProd.190.4.5
iso.org.dod.internet.private.enterprises.ibm.ibmProd.190.4.6
iso.org.dod.internet.private.enterprises.ibm.ibmProd.190.4.7
iso.org.dod.internet.private.enterprises.ibm.ibmProd.190.4.8
iso.org.dod.internet.private.enterprises.ibm.ibmProd.190.4.9
iso.org.dod.internet.private.enterprises.ibm.ibmProd.190.4.10
iso.org.dod.internet.private.enterprises.ibm.ibmProd.190.4.11
iso.org.dod.internet.private.enterprises.ibm.ibmProd.190.4.12
```

Where xxxx is information relevant to your organization.

4. Click **Save** to save the information, using the name **2145ErrorNot**.
5. From the **Send an Internet (SMTP) E-mail** list select the newly created **2145ErrorNot** E-mail and Drag and Drop it on to the **2145 Event** action plan icon in the **Event Action Plan** column. This action causes the **2145ErrorNot** to be call when the **2145 Event** filter is satisfied.

**Related tasks**

“Configuring IBM Director overview” on page 377

You can configure IBM Director for Call-Home and e-mail if it has been installed on a separate machine or is reinstalled on the master console.

## Object types

The following table lists the object codes and corresponding object types.

*Table 57. Object types*

Object code	Object type
0	IC_TYPE_Unknown
1	IC_TYPE_Vlun
2	IC_TYPE_Vlungrp
3	IC_TYPE_Hlun
4	IC_TYPE_Node
5	IC_TYPE_Host
6	IC_TYPE_Hostgrp
7	IC_TYPE_Hws
8	IC_TYPE_Fcgrp
9	IC_TYPE_Rcgrp
10	IC_TYPE_Fcmap
11	IC_TYPE_Rcmap
12	IC_TYPE_Wwpgn
13	IC_TYPE_Cluster
15	IC_TYPE_Hba
16	IC_TYPE_Device
17	IC_TYPE_SCSILun

Table 57. Object types (continued)

Object code	Object type
18	IC_TYPE_Quorum
19	IC_TYPE_TimeSeconds
20	IC_TYPE_ExtSInst
21	IC_TYPE_ExtInst
22	IC_TYPE_Percentage
23	IC_TYPE_VPD_SystemBoard
24	IC_TYPE_VPD_Processor
25	IC_TYPE_VPD_Processor_Cache
26	IC_TYPE_VPD_Memory_Module
27	IC_TYPE_VPD_Fan
28	IC_TYPE_VPD_FC_Card
29	IC_TYPE_VPD_FC_Device
30	IC_TYPE_VPD_Software
31	IC_TYPE_VPD_Front_Panel
32	IC_TYPE_VPD_UPS
33	IC_TYPE_VPD_Port
34	IC_TYPE_FC_Adapter
35	IC_TYPE_Migrate

---

## Event codes

The system generates information and configuration event codes.

There are two different types of event codes:

- Information event codes
- Configuration event codes

Information event codes provide information on the status of an operation. Information event codes are recorded in the error log and an SNMP trap and sometimes an e-mail is generated if the corresponding management flag is set in the Preference cache.

Configuration event codes are generated when configuration parameters are set. Configuration event codes are recorded in a separate log and do not generate SNMP traps or e-mails and their error fixed flags are ignored.

### Related reference

“Information event codes”

The information event codes provide information on the status of a particular operation.

“Configuration event codes” on page 383

Configuration event codes are generated when configuration parameters are set.

## Information event codes

The information event codes provide information on the status of a particular operation.

Information event codes are recorded in the error log and an SNMP trap and sometimes an e-mail is generated if the corresponding management flag is set in the Preference cache.

Information event codes generate information type (I) descriptions or warning type (W) descriptions.

Table 58. Information event codes

Event code	Type	Description
980310	I	Degraded or offline Managed Disk group is now online.
980435	W	Failed to obtain directory listing from remote node
980440	W	Failed to transfer file from remote node
980446	I	Secure Delete complete
980500	W	Featurization Violation
981001	W	Cluster Fabric View has been updated by a multiphase discovery
981007	W	Preferred port is not being used for Managed Disk access
981014	W	LUN Discovery failed. Cluster has a connection to a device through this node but this node cannot discovery the Managed Disks associated LUN correctly.
981020	W	Managed Disk error count warning threshold met.
982003	W	Insufficient Virtual Extents.
982007	W	Migration Stopped.
982009	I	Migrate Complete
982010	W	Copied disk I/O medium error.
983001	I	FlashCopy prepared
983002	I	FlashCopy complete
983003	W	FlashCopy stopped
984001	W	First customer data being pinned in a Virtual Disk working set
984002	I	All customer data in a Virtual Disk working set now unpinned
984003	W	Virtual Disk working set cache mode being changed to synchronous destage because too much pinned data has now been unpinned for that Virtual Disk working set.
984004	I	Virtual Disk working set cache mode now allows asynchronous destage because enough customer data has now been unpinned for that Virtual Disk working set.
985001	I	Remote Copy, background copy complete
985002	I	Remote Copy ready to restart
985003	W	Unable to find path to disk in remote cluster within timeout
987102	W	Node power-off requested from power switch
987103	W	Coldstart
987301	W	Connection to a configured remote cluster has been lost.

Table 58. Information event codes (continued)

Event code	Type	Description
987400	W	The node unexpectedly lost power but has now been restored to the cluster.
988100	W	An overnight maintenance procedure has failed to complete. Resolve any hardware and configuration problems that you are experiencing on the SAN Volume Controller cluster. If the problem persists, contact your IBM service representative for assistance.

#### Related reference

“Event codes” on page 381

The system generates information and configuration event codes.

## Configuration event codes

Configuration event codes are generated when configuration parameters are set.

Configuration event codes are recorded in a separate log and do not generate SNMP traps or e-mails and their error fixed flags are ignored.

Table 59. Configuration event codes

Event code	Description
990101	Modify cluster (attributes in the <b>svctask chcluster</b> command)
990105	Delete node from cluster (attributes in the <b>svctask rmnode</b> command)
990106	Create host (attributes in the <b>svctask mkhost</b> command)
990112	Cluster config dumped to file (attributes in the <b>svctask dumpconfig</b> command)
990117	Create cluster (attributes in the <b>svctask mkcluster</b> command)
990118	Modify node (attributes in the <b>svctask chnode</b> command)
990119	Configure set controller name
990120	Shut down node (attributes in the <b>svctask stopcluster</b> command)
990128	Modify host (attributes in the <b>svctask chhost</b> command)
990129	Delete node (attributes in the <b>svctask rmnode</b> command)
990138	Virtual Disk Modify (attributes in the <b>svctask chvdisk</b> command)
990140	Virtual Disk Delete (attributes in the <b>svctask rmdisk</b> command)
990144	Modify Managed Disk group (attributes in the <b>svctask chmdiskgrp</b> command)
990145	Delete Managed Disk group (attributes in the <b>svctask rmdiskgrp</b> command)
990148	Create Managed Disk group (attributes in the <b>svctask mkmdiskgrp</b> command)
990149	Modify Managed Disk (attributes in the <b>svctask chmdisk</b> command)
990158	VLUN included
990159	Quorum created
990160	Quorum Destroy

Table 59. Configuration event codes (continued)

Event code	Description
990168	Modify the HWS a Virtual Disk is assigned to
990169	Create a new Virtual Disk (attributes in the <b>svctask mkvdisk</b> command)
990173	Add a Managed Disk to Managed Disk group (attributes in the <b>svctask addmdisk</b> command)
990174	Delete a Managed Disk from Managed Disk group (attributes in the <b>svctask rmdmdisk</b> command)
990178	Add a port to a Host (attributes in the <b>svctask addhostport</b> command)
990179	Delete a port from a Host (attributes in the <b>svctask rmhostport</b> command)
990182	Create a Virtual Disk to Host SCSI mapping (attributes in the <b>svctask mkvdiskhostmap</b> command)
990183	Delete an Virtual Disk to Host SCSI mapping (attributes in the <b>svctask rmdiskhostmap</b> command)
990184	Create a FlashCopy mapping (attributes in the <b>svctask mkfcmap</b> command)
990185	Modify a FlashCopy mapping (attributes in the <b>svctask chfcmap</b> command)
990186	Delete a FlashCopy mapping (attributes in the <b>svctask rmfcmap</b> command)
990187	Prepare a FlashCopy mapping (attributes in the <b>svctask prestartfcmap</b> command)
990188	Prepare a FlashCopy consistency group (attributes in the <b>svctask prestartfcconsistgrp</b> command)
990189	Trigger a FlashCopy mapping (attributes in the <b>svctask startfcmap</b> command)
990190	Trigger a FlashCopy consistency group (attributes in the <b>svctask startfcconsistgrp</b> command)
990191	Stop a FlashCopy mapping (attributes in the <b>svctask stopfcmap</b> command)
990192	Stop a FlashCopy consistency group (attributes in the <b>svctask stopfcconsistgrp</b> command)
990193	FlashCopy set name
990194	Delete a list of ports from a Host (attributes in the <b>svctask rmhostport</b> command)
990196	Shrink a Virtual Disk.
990197	Expand a Virtual Disk (attributes in the <b>svctask expandvdisksize</b> command)
990198	Expand single extent a Virtual Disk
990199	Modify govern a Virtual Disk
990203	Initiate manual Managed Disk discovery (attributes in the <b>svctask detectmdisk</b> command)
990204	Create FlashCopy consistency group (attributes in the <b>svctask mkfcconsistgrp</b> command)

Table 59. Configuration event codes (continued)

Event code	Description
990205	Modify FlashCopy consistency group (attributes in the <b>svctask chfcconsistgrp</b> command)
990206	Delete FlashCopy consistency group (attributes in the <b>svctask rmfcconsistgrp</b> command)
990207	Delete a list of Hosts (attributes in the <b>svctask rmhost</b> command)
990213	Change the HWS a node belongs to (attributes in the <b>svctask chiogrp</b> command)
990216	Apply software upgrade (attributes in the <b>svcservicetask applysoftware</b> command)
990219	Analyze error log (attributes in the <b>svctask finderr</b> command)
990220	Dump error log (attributes in the <b>svctask dumperrlog</b> command)
990221	Clear error log (attributes in the <b>svctask clearerrlog</b> command)
990222	Fix error log entry (attributes in the <b>svctask cherrstate</b> command)
990223	Migrate a single extent (attributes in the <b>svctask migrateexts</b> command)
990224	Migrate a number of extents
990225	Create Remote Copy relationship (attributes in the <b>svctask mkrcrelationship</b> command)
990226	Modify Remote Copy relationship (attributes in the <b>svctask chrcrelationship</b> command)
990227	Delete Remote Copy relationship (attributes in the <b>svctask rmrcrelationship</b> command)
990229	Start Remote Copy relationship (attributes in the <b>svctask startrcrelationship</b> command)
990230	Stop Remote Copy relationship (attributes in the <b>svctask stoprcrelationship</b> command)
990231	Switch a Remote Copy relationship (attributes in the <b>svctask switchrcrelationship</b> command)
990232	Start Remote Copy consistency group (attributes in the <b>svctask startrcconsistgrp</b> command)
990233	Stop Remote Copy consistency group (attributes in the <b>svctask stoprcconsistgrp</b> command)
990234	Switch a Remote Copy consistency group (attributes in the <b>svctask switchrcconsistgrp</b> command)
990235	Managed Disk migrated to a Managed Disk group
990236	Virtual Disk migrated to a new Managed Disk
990237	Create partnership with remote cluster (attributes in the <b>svctask mkpartnership</b> command)
990238	Modify partnership with remote cluster (attributes in the <b>svctask chpartnership</b> command)
990239	Delete partnership with remote cluster (attributes in the <b>svctask rmpartnership</b> command)
990240	Create Remote Copy consistency group (attributes in the <b>svctask mkrcconsistgrp</b> command)

Table 59. Configuration event codes (continued)

Event code	Description
990241	Modify Remote Copy consistency group (attributes in <code>svctask chrcconsistgrp</code> )
990242	Delete Remote Copy consistency group (attributes in the <code>svctask rmrcconsistgrp</code> command)
990245	Node pend
990246	Node remove
990247	Node unpend
990380	Time zone changed (attributes in the <code>svctask settimezone</code> command)
990383	Change cluster time (attributes in the <code>svctask setclustertime</code> command)
990385	System time changed
990386	SSH key added (attributes in the <code>svctask addsshkey</code> command)
990387	SSH key removed (attributes in the <code>svctask rmsshkey</code> command)
990388	All SSH keys removed (attributes in the <code>svctask rmallsshkeys</code> command)
990390	Add node to the cluster
990395	Shutdown or reset node
990410	Software Install started
990415	Software Install completed
990420	Software Install failed
990430	Planar Serial Number changed
990501	The featurization has changed. See feature log for details.
991024	IO tracing has finished, trigger occurred for given Managed Disk.

#### Related reference

“Event codes” on page 381

The system generates information and configuration event codes.

---

## Accessibility

Accessibility features help a user who has a physical disability, such as restricted mobility or limited vision, to use software products successfully.

### Features

These are the major accessibility features in the SAN Volume Controller master console:

- You can use screen-reader software and a digital speech synthesizer to hear what is displayed on the screen. The following screen readers have been tested: JAWS v4.5 and IBM Home Page Reader v3.0.
- You can operate all features using the keyboard instead of the mouse.



## Navigating by keyboard

You can use keys or key combinations to perform operations and initiate many menu actions that can also be done through mouse actions. You can navigate the SAN Volume Controller Console and help system from the keyboard by using the following key combinations:

- To traverse to the next link, button, or topic, press Tab inside a frame (page).
- To expand or collapse a tree node, press → or ←, respectively.
- To move to the next topic node, press V or Tab.
- To move to the previous topic node, press ^ or Shift+Tab.
- To scroll all the way up or down, press Home or End, respectively.
- To go back, press Alt+←.
- To go forward, press Alt+→.
- To go to the next frame, press Ctrl+Tab.
- To move to the previous frame, press Shift+Ctrl+Tab.
- To print the current page or active frame, press Ctrl+P.
- To select, press Enter.

## Accessing the publications

You can view the publications for the SAN Volume Controller in Adobe Portable Document Format (PDF) using the Adobe Acrobat Reader. The PDFs are provided on a CD that is packaged with the product or you can access them at the following Web site:

<http://www-1.ibm.com/servers/storage/support/virtual/2145.html>

### Related reference

“SAN Volume Controller library and related publications” on page xvi

A list of other publications that are related to this product are provided to you for your reference.

---

## Notices

This information was developed for products and services offered in the U.S.A.

IBM may not offer the products, services, or features discussed in this document in other countries. Consult your local IBM representative for information on the products and services currently available in your area. Any reference to an IBM product, program, or service is not intended to state or imply that only that IBM product, program, or service may be used. Any functionally equivalent product, program, or service that does not infringe any IBM intellectual property right may be used instead. However, it is the user's responsibility to evaluate and verify the operation of any non-IBM product, program, or service.

IBM may have patents or pending patent applications covering subject matter described in this document. The furnishing of this document does not give you any license to these patents. You can send license inquiries, in writing, to:

*IBM Director of Licensing  
IBM Corporation*

*North Castle Drive  
Armonk, NY 10504-1785  
U.S.A.*

**The following paragraph does not apply to the United Kingdom or any other country where such provisions are inconsistent with local law:**

INTERNATIONAL BUSINESS MACHINES CORPORATION PROVIDES THIS PUBLICATIONS "AS IS" WITHOUT WARRANTY OF ANY KIND, EITHER EXPRESS OR IMPLIED, INCLUDING, BUT NOT LIMITED TO, THE IMPLIED WARRANTIES OF NON-INFRINGEMENT, MERCHANTABILITY OR FITNESS FOR A PARTICULAR PURPOSE. Some states do not allow disclaimer of express or implied warranties in certain transactions, therefore, this statement may not apply to you.

This information could include technical inaccuracies or typographical errors. Changes are periodically made to the information herein; these changes will be incorporated in new editions of the publication. IBM may make improvements and/or changes in the product(s) and/or the program(s) described in this publication at any time without notice.

Any references in this information to non-IBM Web sites are provided for convenience only and do not in any manner serve as an endorsement of those Web sites. The materials at those Web sites are not part of the materials for this IBM product and use of those Web sites is at your own risk.

IBM may use or distribute any of the information you supply in any way it believes appropriate without incurring any obligation to you.

Any performance data contained herein was determined in a controlled environment. Therefore, the results obtained in other operating environments may vary significantly. Some measurements may have been made on development-level systems and there is no guarantee that these measurements will be the same on generally available systems. Furthermore, some measurement may have been estimated through extrapolation. Actual results may vary. Users of this document should verify the applicable data for their specific environment.

Information concerning non-IBM products was obtained from the suppliers of those products, their published announcements or other publicly available sources. IBM has not tested those products and cannot confirm the accuracy of performance, compatibility or any other claims related to non-IBM products. Questions on the capabilities of non-IBM products should be addressed to the suppliers of those products.

All statements regarding IBM's future direction or intent are subject to change or withdrawal without notice, and represent goals and objectives only.

This information is for planning purposes only. The information herein is subject to change before the products described become available.

This information contains examples of data and reports used in daily business operations. To illustrate them as completely as possible, the examples include the names of individuals, companies, brands, and products. All of these names are fictitious and any similarity to the names and addresses used by an actual business enterprise is entirely coincidental.

#### **Related reference**

“Trademarks”

## Trademarks

The following terms are trademarks of the International Business Machines Corporation in the United States, other countries, or both:

- AIX
- e (logo)
- Enterprise Storage Server
- FlashCopy
- IBM
- Tivoli
- TotalStorage
- xSeries

Intel and Pentium are trademarks of Intel Corporation in the United States, other countries, or both.

Java and all Java-based trademarks are trademarks of Sun Microsystems, Inc. in the United States, other countries, or both.

Microsoft and Windows are trademarks of Microsoft Corporation in the United States, other countries, or both.

UNIX is a registered trademark of The Open Group in the United States and other countries.

Linux is a trademark of Linus Torvalds in the United States, other countries, or both.

Other company, product, and service names may be trademarks or service marks of others.

---

## Glossary

Ensure you are familiar with the list of terms and their definitions used in this guide.

### A

#### **application server**

A host that is attached to the storage area network (SAN) and that runs applications.

### C

**cache** A high-speed memory or storage device used to reduce the effective time required to read data from or write data to lower-speed memory or a device. Read cache holds data in anticipation that it will be requested by a client. Write cache holds data written by a client until it can be safely stored on more permanent storage media such as disk or tape.

#### **Call Home**

A communication service that links a machine to a service provider. The machine can use this link to place a call to IBM or to another service provider when service is required. With access to the machine, service

personnel can perform service tasks, such as viewing error and problem logs or initiating trace and dump retrievals.

**cluster**

In SAN Volume Controller, a pair of nodes that provides a single configuration and service interface.

**concurrent maintenance**

Service that is performed on a unit while it is operational.

**configuration node**

A node that acts as the focal point for configuration commands and manages the data that describes the cluster configuration.

**consistency group**

A group of copy relationships between virtual disks that are managed as a single entity.

**consistent copy**

In a Remote Copy relationship, a copy of a secondary virtual disk (VDisk) that is identical to the primary VDisk from the viewpoint of a host system, even if a power failure occurred while I/O activity was in progress.

**container**

- IBM definition: A visual user-interface component that holds objects.
- HP definition:
  1. Any entity that is capable of storing data, whether it is a physical device or a group of physical devices.
  2. A virtual, internal controller structure representing either a single disk or a group of disk drives linked as a storageset. Stripesets and mirrorsets are examples of storageset containers that the controller uses to create units.

**copied**

In a FlashCopy relationship, a state that indicates that a copy has been started after the copy relationship was created. The copy process is complete and the target disk has no further dependence on the source disk.

**copying**

A status condition that describes the state of a pair of virtual disks (VDisks) that have a copy relationship. The copy process has been started but the two virtual disks are not yet synchronized.

**D****data migration**

The movement of data from one physical location to another without disrupting I/O operations.

**degraded**

Pertaining to a valid configuration that has suffered a failure but continues to be supported and legal. Typically, a repair action can be performed on a degraded configuration to restore it to a valid configuration.

**dependent write operations**

A set of write operations that must be applied in the correct order to maintain cross-volume consistency.

**destage**

A write command initiated by the cache to flush data to disk storage.

**device**

- In the CIM Agent, the storage server that processes and hosts client application requests.
- IBM definition: A piece of equipment that is used with the computer and does not generally interact directly with the system, but is controlled by a controller.
- HP definition: In its physical form, a magnetic disk that can be attached to a SCSI bus. The term is also used to indicate a physical device that has been made part of a controller configuration; that is, a physical device that is known to the controller. Units (virtual disks) can be created from devices after the devices have been made known to the controller.

**directed maintenance procedures**

The set of maintenance procedures that can be run for a cluster. These procedures are documented in the service guide.

**disconnected**

In a Remote Copy relationship, pertains to two clusters when they cannot communicate.

**disk controller**

A device that coordinates and controls the operation of one or more disk drives and synchronizes the operation of the drives with the operation of the system as a whole. Disk controllers provide the storage that the cluster detects as managed disks (MDisks).

**disk zone**

A zone defined in the storage area network (SAN) fabric in which the SAN Volume Controller can detect and address the logical units that the disk controllers present.

**E****error code**

A value that identifies an error condition.

**ESS** See *IBM TotalStorage Enterprise Storage Server<sup>®</sup>*.

**IBM TotalStorage Enterprise Storage Server (ESS)**

An IBM product that provides an intelligent disk-storage subsystem across an enterprise.

**exclude**

To remove a managed disk (MDisk) from a cluster because of certain error conditions.

**excluded**

In SAN Volume Controller, the status of a managed disk that the cluster has removed from use after repeated access errors.

**extent** A unit of data that manages the mapping of data between managed disks and virtual disks.

**F****failover**

In SAN Volume Controller, the function that occurs when one redundant part of the system takes over the workload of another part of the system that has failed.

**fibre channel**

A technology for transmitting data between computer devices at a data rate of up to 4 Gbps. It is especially suited for attaching computer servers to shared storage devices and for interconnecting storage controllers and drives.

**fibre-channel extender**

A long-distance communication device that interconnects storage area network (SAN) fabric components.

**FC** See *fibre channel*.

**FlashCopy service**

In SAN Volume Controller, a copy service that duplicates the contents of a source virtual disk (VDisk) to a target VDisk. In the process, the original contents of the target VDisk are lost. See also *point-in-time copy*.

**FlashCopy mapping**

A relationship between two virtual disks.

**FlashCopy relationship**

See *FlashCopy mapping*.

**H**

**HBA** See *host bus adapter*.

**host bus adapter (HBA)**

In SAN Volume Controller, an interface card that connects a host bus, such as a peripheral component interconnect (PCI) bus, to the storage area network.

**host** An open-systems computer that is connected to the SAN Volume Controller through a fibre-channel interface.

**host ID**

In SAN Volume Controller, a numeric identifier assigned to a group of host fibre-channel ports for the purpose of logical unit number (LUN) mapping. For each host ID, there is a separate mapping of Small Computer System Interface (SCSI) IDs to virtual disks (VDisks).

**host zone**

A zone defined in the storage area network (SAN) fabric in which the hosts can address the SAN Volume Controllers.

**I****IBM Subsystem Device Driver (SDD)**

An IBM pseudo device driver designed to support the multipath configuration environments in IBM products.

**idling** The status of a pair of virtual disks (VDisks) that have a defined copy relationship for which no copy activity has yet been started.

**illegal configuration**

A configuration that will not operate and will generate an error code to indicate the cause of the problem.

**image mode**

An access mode that establishes a one-to-one mapping of extents in the managed disk (MDisk) with the extents in the virtual disk (VDisk). See also *managed space mode* and *unconfigured mode*.

**image VDisk**

A virtual disk (VDisk) in which there is a direct block-for-block translation from the managed disk (MDisk) to the VDisk.

**inconsistent**

In a Remote Copy relationship, pertaining to a secondary virtual disk (VDisk) that is being synchronized with the primary VDisk.

**input/output (I/O)**

Pertaining to a functional unit or communication path involved in an input process, an output process, or both, concurrently or not, and to the data involved in such a process.

**integrity**

The ability of a system to either return only correct data or respond that it cannot return correct data.

**Internet Protocol (IP)**

In the Internet suite of protocols, a connectionless protocol that routes data through a network or interconnected networks and acts as an intermediary between the higher protocol layers and the physical network.

**I/O** See *input/output*.

**I/O group**

A collection of virtual disks (VDisks) and node relationships that present a common interface to host systems.

**I/O throttling rate**

The maximum rate at which an I/O transaction is accepted for this virtual disk (VDisk).

**IP** See *Internet Protocol*.

**J****JBOD (just a bunch of disks)**

IBM definition: See *non-RAID*. HP definition: A group of single-device logical units not configured into any other container type.

**L**

**LBA** See *logical block address*.

**local fabric**

In SAN Volume Controller, those storage area network (SAN) components (such as switches and cables) that connect the components (nodes, hosts, switches) of the local cluster together.

**local/remote fabric interconnect**

The storage area network (SAN) components that are used to connect the local and remote fabrics together.

**logical block address (LBA)**

The block number on a disk.

**logical unit (LU)**

An entity to which Small Computer System Interface (SCSI) commands are addressed, such as a virtual disk (VDisk) or managed disk (MDisk).

**logical unit number (LUN)**

The SCSI identifier of a logical unit within a target. (S)

**LU** See *logical unit*.

**LUN** See *logical unit number*.

## M

### **managed disk (MDisk)**

A Small Computer System Interface (SCSI) logical unit that a redundant array of independent disks (RAID) controller provides and a cluster manages. The MDisk is not visible to host systems on the storage area network (SAN).

### **managed disk group**

A collection of managed disks (MDisks) that, as a unit, contain all the data for a specified set of virtual disks (VDisks).

### **mapping**

See *FlashCopy mapping*.

### **master virtual disk**

The virtual disk (VDisk) that contains a production copy of the data and that an application accesses. See also *auxiliary virtual disk*.

**MDisk** See *managed disk*.

### **migration**

See *data migration*.

### **mirrorset**

IBM definition: See *RAID-1*. HP definition: A RAID storage set of two or more physical disks that maintain a complete and independent copy of the data from the virtual disk. This type of storage set has the advantage of being highly reliable and extremely tolerant of device failure. Raid level 1 storage sets are referred to as mirrorsets.

## N

**node** One SAN Volume Controller. Each node provides virtualization, cache, and Copy Services to the storage area network (SAN).

### **node rescue**

In SAN Volume Controller, the process by which a node that has no valid software installed on its hard disk drive can copy the software from another node connected to the same fibre-channel fabric.

### **non-RAID**

Disks that are not in a redundant array of independent disks (RAID). IBM definition: Disks that are not in a redundant array of independent disks (RAID). HP definition: See *JBOD*.

## O

**offline** Pertaining to the operation of a functional unit or device that is not under the continual control of the system or of a host.

**online** Pertaining to the operation of a functional unit or device that is under the continual control of the system or of a host.

## P

### **partition**

- IBM definition: A logical division of storage on a fixed disk.
- HP definition: A logical division of a container represented to the host as a logical unit.



**partnership**

In Remote Copy, the relationship between two clusters. In a cluster partnership, one cluster is defined as the local cluster and the other cluster as the remote cluster.

**paused**

In SAN Volume Controller, the process by which the cache component quiesces all ongoing I/O activity below the cache layer.

**pend** To cause to wait for an event.

**port** The physical entity within a host, SAN Volume Controller, or disk controller system that performs the data communication (transmitting and receiving) over the fibre channel.

**primary virtual disk**

In a Remote Copy relationship, the target of write operations issued by the host application.

**PuTTY**

A free implementation of Telnet and SSH for Windows 32-bit platforms

**Q****quorum disk**

A managed disk (MDisk) that contains quorum data and that a cluster uses to break a tie and achieve a quorum.

**R**

**RAID** See *redundant array of independent disks*.

**RAID 0**

- IBM definition: RAID 0 allows a number of disk drives to be combined and presented as one large disk. RAID 0 does not provide any data redundancy. If one drive fails, all data is lost.
- HP definition: A RAID storage set that stripes data across an array of disk drives. A single logical disk spans multiple physical disks, allowing parallel data processing for increased I/O performance. While the performance characteristics of RAID level 0 is excellent, this RAID level is the only one that does not provide redundancy. RAID level 0 storage sets are referred to as stripesets.

**RAID 1**

SNIA dictionary definition: A form of storage array in which two or more identical copies of data are maintained on separate media. IBM definition: A form of storage array in which two or more identical copies of data are maintained on separate media. Also known as mirrorset. HP definition: See *mirrorset*.

**redundant array of independent disks**

A collection of two or more disk drives that present the image of a single disk drive to the system. In the event of a single device failure, the data can be read or regenerated from the other disk drives in the array.

**RAID 5**

- SNIA definition: A form of parity RAID in which the disks operate independently, the data strip size is no smaller than the exported block size, and parity check data is distributed across the array's disks. (S)
- IBM definition: See above.

- HP definition: A specially developed RAID storageset that stripes data and parity across three or more members in a disk array. A RAIDset combines the best characteristics of RAID level 3 and RAID level 5. A RAIDset is the best choice for most applications with small to medium I/O requests, unless the application is write intensive. A RAIDset is sometimes called parity RAID. RAID level 3/5 storagesets are referred to as RAIDsets.

### **RAID 10**

A type of RAID that optimizes high performance while maintaining fault tolerance for up to two failed disk drives by striping volume data across several disk drives and mirroring the first set of disk drives on an identical set.

### **redundant SAN**

A storage area network (SAN) configuration in which any one single component might fail, but connectivity between the devices within the SAN is maintained, possibly with degraded performance. This configuration is normally achieved by splitting the SAN into two, independent, counterpart SANs. See also *counterpart SAN*.

### **rejected**

A status condition that describes a node that the cluster software has removed from the working set of nodes in the cluster.

### **relationship**

In Remote Copy, the association between a master virtual disk (VDisk) and an auxiliary VDisk. These VDIsks also have the attributes of a primary or secondary VDisk. See also *auxiliary virtual disk*, *master virtual disk*, *primary virtual disk*, and *secondary virtual disk*.

### **Remote Copy**

In SAN Volume Controller, a copy service that enables host data on a particular source virtual disk (VDisk) to be copied to the target VDisk designated in the relationship.

## **S**

**SAN** See *storage area network*.

### **SAN Volume Controller fibre-channel port fan in**

The number of hosts that can see any one SAN Volume Controller port.

**SCSI** See *Small Computer Systems Interface*.

### **sequential VDisk**

A virtual disk that uses extents from a single managed disk.

### **Small Computer System Interface (SCSI)**

A standard hardware interface that enables a variety of peripheral devices to communicate with one another.

### **secondary virtual disk**

In Remote Copy, the virtual disk (VDisk) in a relationship that contains a copy of data written by the host application to the primary VDisk.

### **Simple Network Management Protocol (SNMP)**

In the Internet suite of protocols, a network management protocol that is used to monitor routers and attached networks. SNMP is an application-layer protocol. Information on devices managed is defined and stored in the application's Management Information Base (MIB).

**SNMP** See *Simple Network Management Protocol*.

**stand-alone relationship**

In FlashCopy and Remote Copy, relationships that do not belong to a consistency group and that have a null consistency group attribute.

**stop** A configuration command that is used to stop the activity for all copy relationships in a consistency group.

**stopped**

The status of a pair of virtual disks (VDisks) that have a copy relationship that the user has temporarily broken because of a problem.

**storage area network (SAN)**

A network whose primary purpose is the transfer of data between computer systems and storage elements and among storage elements. A SAN consists of a communication infrastructure, which provides physical connections, and a management layer, which organizes the connections, storage elements, and computer systems so that data transfer is secure and robust. (S)

**stripeset**

See *RAID 0*.

**superuser authority**

The level of access required to add users.

**suspended**

The status of a pair of virtual disks (VDisks) that have a copy relationship that has been temporarily broken because of a problem.

**symmetric virtualization**

A virtualization technique in which the physical storage in the form of Redundant Array of Independent Disks (RAID) is split into smaller chunks of storage known as *extents*. These extents are then concatenated, using various policies, to make virtual disks (VDisks). See also *asymmetric virtualization*.

**synchronized**

In Remote Copy, the status condition that exists when both virtual disks (VDisks) of a pair that has a copy relationship contain the same data.

**T**

**trigger**

To initiate or reinstate copying between a pair of virtual disks (VDisks) that have a copy relationship.

**U**

**unconfigured mode**

A mode in which I/O operations cannot be performed. See also *image mode* and *managed space mode*.

**uninterruptible power supply**

A device connected between a computer and its power source that protects the computer against blackouts, brownouts, and power surges. The uninterruptible power supply contains a power sensor to monitor the supply and a battery to provide power until an orderly shutdown of the system can be performed.

**unit identifiers (UIDs)**

A unit identifier can be one of the following:

1. an integer expression whose value must be zero or positive
2. an \* (asterisk) that corresponds to unit 5 for input or unit 6 for output
3. the name of a character array, character array element, or character substring for an internal file

**V****valid configuration**

A configuration that is supported.

**VDisk** See *virtual disk*.

**virtual disk (VDisk)**

In SAN Volume Controller, a device that host systems attached to the storage area network (SAN) recognize as a Small Computer System Interface (SCSI) disk.

**virtualization**

In the storage industry, a concept in which a pool of storage is created that contains several disk subsystems. The subsystems can be from various vendors. The pool can be split into virtual disks that are visible to the host systems that use them.

**virtualized storage**

Physical storage that has virtualization techniques applied to it by a virtualization engine.

**vital product data (VPD)**

Information that uniquely defines system, hardware, software, and microcode elements of a processing system.

**W****worldwide node name (WWNN)**

An identifier for an object that is globally unique. WWNNs are used by Fibre Channel and other standards.

**WWNN**

See *worldwide node name*.

**WWPN**

See *worldwide port name*.

**worldwide port name (WWPN)**

A unique 64-bit identifier associated with a fibre-channel adapter port. The WWPN is assigned in an implementation- and protocol-independent manner.

---

# Index

## A

- about this guide xiii
- Access Logix 274
- accessibility
  - keyboard 387
  - shortcut keys 387
- adding
  - storage controllers
    - using the 266
    - using the CLI (command-line interface) 270
- advanced functions
  - overview
  - using 152
  - using CLI (command-line interface) 222
  - using SAN Volume Controller Console 137
- Remote Copy
  - using the 152
- analyzing error logs 153, 228
- audience xiii

## B

- book
  - about this xiii

## C

- call-home feature
  - enabling 89
- certificate
  - truststore 74
- Cisco Systems
  - MDS 9000 Caching Services Module 1
  - MDS 9000 switch 1
- CLI (command-line interface)
  - examples 180
  - getting started 169
  - issuing commands from a PuTTY SSH client system 174
  - preparing SSH client systems 171, 172
  - scenarios 180
  - upgrading software 241
  - using to set cluster features 178
- clusters
  - configuring
    - using the 152
    - using the CLI (command-line interface) 222
  - creating
    - from the front panel 69
  - maintaining 157
  - overview 11
  - resetting the SSH fingerprint 164
  - setting
    - features 178
    - time 178
  - setting cluster time 116
  - shutting down 165, 229

- codes
  - configuration events 383
  - events 381
  - information events 382
- command-line interface (CLI)
  - examples 180
  - getting started 169
  - issuing commands from a PuTTY SSH client system 174
  - preparing SSH clients 171, 172
  - scenarios 180
  - upgrading software 241
  - using to set cluster features 178
  - using to set cluster time 178
- commands
  - svcinfo caterlog 250
  - svcinfo caterlogbyseqnum 250
  - svcinfo lserrlogbyxxxx 250
  - svcinfo lsxxxx 250
  - svcinfo lsxxxxcandidate 250
  - svcinfo lsxxxxdumps 250
  - svcinfo lsxxxxextent 250
  - svcinfo lsxxxxmember 250
  - svcinfo lsxxxxprogress 250
  - svcservicetask rmnode 250
  - svctask rmnode 250
- communications
  - determining between hosts and virtual disks 201
- configuration
  - event codes 383
  - maximum sizes 64
  - rules 49
- configuration requirements 62
- configuring
  - clusters 106, 177
    - using the 152
    - using the CLI (command-line interface) 222
  - disk controllers 253, 254, 255, 256, 257
  - Enterprise Storage Server 260, 293
  - FASTt Storage Manager 260, 301
  - FASTt Storage Server 260, 299
  - PuTTY 82
  - remote support 86
  - SAN Volume Controller 75
  - secure shell (SSH) 80
  - SSH (secure shell) 80
  - switches 57
- consistency group, Remote Copy 48
- consistency groups, FlashCopy 39
  - creating 133
  - deleting 137
  - starting 136
  - stopping 136
- console
  - master
    - overview 73
  - SAN Volume Controller
    - portfolio 104

- console *(continued)*
  - SAN Volume Controller *(continued)*
    - starting 102
    - task bar 104
    - work area 104
- controllers
  - adding
    - using the 266
    - using the CLI (command-line interface) 270
  - advanced functions
    - EMC CLARiiON 281
    - EMC Symmetrix 289
    - Enterprise Storage Server 297
    - FASTT 304
    - HDS Lightning 312
    - HDS Thunder 321
    - HP StorageWorks 340
  - concurrent maintenance
    - EMC CLARiiON 278
    - EMC Symmetrix 286
    - Enterprise Storage Server 295
    - FASTT 302
    - HDS Lightning 311
    - HDS Thunder 318
    - HP StorageWorks 336
  - configuration
    - EMC CLARiiON 273, 274, 281
    - EMC Symmetrix 285, 290
    - Enterprise Storage Server 293
    - FASTT 298, 299
    - HDS Lightning 309
    - HDS Thunder 317
    - HP StorageWorks 329, 332, 334, 341, 350
    - HPQ EVA 346
  - controller settings
    - EMC CLARiiON 282
  - firmware
    - EMC CLARiiON 278
    - EMC Symmetrix 286
    - Enterprise Storage Server 295
    - FASTT 302
    - HDS Lightning 310
    - HDS Thunder 318
    - HP StorageWorks 336
    - HPQ EVA 347
  - global settings
    - EMC CLARiiON 282
    - EMC Symmetrix 291
    - FASTT 308
    - HDS Thunder 324
    - Lightning 315
  - host settings
    - HPQ EVA 351
  - interface
    - FASTT 305
    - HP StorageWorks 337, 350
  - logical unit creation and deletion
    - EMC CLARiiON 281
    - EMC Symmetrix 289
    - Enterprise Storage Server 297
    - FASTT 305
  - controllers *(continued)*
    - logical unit creation and deletion *(continued)*
      - HDS Thunder 322
      - HP StorageWorks 340
      - HPQ EVA 348, 349
    - logical unit presentation
      - HPQ EVA 349
    - LU configuration
      - Lightning 313
    - LU settings
      - EMC CLARiiON 284
      - EMC Symmetrix 292
      - FASTT 308
      - HDS Thunder 326
      - HP StorageWorks 343
      - HPQ EVA 350
      - Lightning 316
    - models
      - EMC CLARiiON 277
      - EMC Symmetrix 285
      - Enterprise Storage Server 295
      - FASTT 302
      - HDS Lightning 310
      - HDS Thunder 317
      - HP StorageWorks 335
      - HPQ EVA 347
    - port settings
      - EMC CLARiiON 283
      - EMC Symmetrix 291
      - HDS Thunder 325
      - HP StorageWorks 343
      - Lightning 316
    - quorum disks
      - EMC CLARiiON 280
      - EMC Symmetrix 288
      - Enterprise Storage Server 296
      - FASTT 303
      - HDS Lightning 312
      - HDS Thunder 320
      - HP StorageWorks 338
      - HPQ EVA 348
    - registering
      - EMC CLARiiON 275
    - removing
      - using the 268
      - using the CLI (command-line interface) 271
    - settings
      - FASTT 306, 307
      - HDS Thunder 323, 325
      - HP StorageWorks 342, 345
      - Lightning 315, 316
    - sharing
      - EMC CLARiiON 279
      - EMC Symmetrix 287
      - Enterprise Storage Server 296
      - FASTT 303
      - HDS Lightning 311
      - HDS Thunder 319
      - HP StorageWorks 337
      - HPQ EVA 347

- controllers (*continued*)
  - switch zoning
    - EMC CLARiiON 279
    - EMC Symmetrix 288
    - Enterprise Storage Server 296
    - HP StorageWorks 338
    - HPQ EVA 348
  - user interface
    - CLARiiON 279
    - ESS 295
    - FASTT 302
    - HDS Thunder 318
    - HPQ EVA 347
    - Lightning 311
    - Symmetrix 287
- conventions
  - emphasis in text xv
  - numbering xvi
- creating
  - clusters
    - from the front panel 69
    - from the SAN Volume Controller 105
  - FlashCopy
    - mappings 133, 196, 199
  - SSH keys 81
  - virtual disk-to-host mappings 195

**D**

- data migration
  - FASTT 304
- deleting
  - FlashCopy
    - mappings 135
  - hosts 149
  - nodes 155, 222
- determining
  - communications between hosts and virtual disks 201
- discovering
  - managed disks 187, 190
- disk controller systems
  - renaming 265
- disk controllers
  - overview 20
- disks
  - migrating 219
- disruptive software upgrade
  - using the CLI (command-line interface) 242
- downloading
  - virtual network computing (VNC) server 87
  - VNC (virtual network computing) server 87

**E**

- e-mail
  - setting up 91, 92, 378, 379
- emphasis in text xv
- enabling
  - call-home feature 89
  - cluster maintenance procedure 157

- errors
  - notification settings 154
- events
  - codes 381
  - configuration 383
  - information 382
  - setting up an action plan for 377
- examples
  - using the CLI (command-line interface) 180
  - using the SAN Volume Controller Console 118
- expanding
  - virtual disks 214
- expiration 74
- expired
  - certificate 74
- extents
  - migrating
    - using the CLI (command-line interface) 217

**F**

- features
  - setting
    - using the CLI (command-line interface) 178
  - viewing logs 167
- FlashCopy
  - consistency groups 39
  - mappings 35, 195
  - overview 32

**G**

- general cluster properties
  - viewing 117, 179
- generating new truststore certificate 74
- getting started
  - using 357
  - using the CLI (command-line interface) 169
  - using the command-line interface (CLI) 169
  - using the SAN Volume Controller Console 101
- guide
  - about this xiii
  - who should read xiii

**H**

- HBAs (host bus adapters)
  - configuration 55
- host bus adapters (HBAs)
  - configuration 55
- hosts
  - creating 131
  - deleting 149
  - overview 29

**I**

- I/O groups
  - overview 15

- IBM Director
  - configuring 377
  - overview 88, 377
  - starting 88
- image-mode VDisks
  - converting to managed mode
    - using 151
    - using CLI (command-line interface) 221
- information
  - center xvi
  - event codes 382
- installing
  - SAN Volume Controller Console 361, 366
  - software 250
  - verification 371
- IP addresses
  - modifying 165, 224
- issuing
  - CLI commands 174

## K

- keyboard 387
  - shortcut keys 387

## L

- language 154, 227
- listing
  - dump files 157, 226
  - log files 157, 226

## M

- maintaining
  - passwords 158, 179, 226
  - SSH keys 225
- maintenance procedures
  - clusters 157
- managed disk (MDisk) groups
  - creating 125
- managed disk groups
  - creating using the CLI 189
- managed mode virtual disks
  - converting from image mode
    - using the 151
    - using the CLI (command-line interface) 221
- mappings, FlashCopy
  - creating 133
  - deleting 135
  - starting 135
  - stopping 135
- master console
  - error 74
- measurements xvi
- migrating
  - extents
    - using the CLI (command-line interface) 217
- migration 150, 304
- mkcertificate.bat 74

- monitoring
  - software upgrades, automatic 247, 248

## N

- node status 13
- nodes
  - adding 120, 181
  - configuration 14, 56
  - deleting 155
  - overview 11
  - rescuing 246
  - viewing
    - general details 125, 186
- notices
  - legal 387

## O

- operating over long distances 355
- ordering publications xviii
- overview
  - advanced functions
    - using the 152
    - using the CLI (command-line interface) 222
    - using the SAN Volume Controller Console 137
  - creating a cluster 105
  - IBM Director 88
  - SSH (secure shell) 248
  - zoning 351

## P

- plink utility
  - running 175
- power requirements 57
- preinstalled software
  - recovering from installation failures 251
- preparing
  - SSH client system
    - overview 171
    - to issue CLI commands 171, 172
- public SSH keys
  - storing 160
- publications
  - ordering xviii
- PuTTY 82
  - configuring 82
  - issuing CLI commands from 174
  - running the plink utility 175
- PuTTY scp
  - overview 248

## R

- related information xvi
- relationships, Remote Copy
  - overview 46
- Remote Copy
  - overview 44, 48



- Remote Copy (*continued*)
  - using the 152
  - partnerships 45
  - zoning considerations 354
- remote support
  - configuring 86
- removing
  - nodes 155
  - storage controllers
    - using the 268
    - using the CLI (command-line interface) 271
- renaming
  - disk controller systems 265
- requirements 358, 360
- resetting
  - SSH fingerprint for a cluster 164
- running
  - PuTTY plink utility 175

## S

- SAN Volume Controller
  - configuring 75
  - Console
    - banner area 103
    - examples 118
    - layout 103
    - portfolio 104
    - post installation tasks 371
    - scenarios 118
    - starting 102
    - task bar 104
    - using to create a cluster 105
    - work area 104
  - overview 1
  - removing 374
  - upgrading software 94
- SAN Volume Controller console
  - master
    - upgrading software 94
- SAN Volume Controller Console
  - advanced functions 137
  - banner area 103
  - launching the Web application 115
  - layout 103
  - starting 101
- scenarios
  - using the CLI (command-line interface) 180
  - using the SAN Volume Controller Console 118
- secure shell (SSH) 78
  - client system
    - issuing CLI commands from 174
    - overview 171
    - preparing to issue CLI commands 171, 172
  - configuring 80
  - creating keys 81
  - installing 83
  - keys
    - assigning 83
    - generating 81
    - storing 160

- secure shell (SSH) (*continued*)
  - overview 248
- security
  - overview 78
- servers
  - virtual network computing (VNC) 87
  - VNC (virtual network computing) 87
- setting
  - action plan for events 377
  - cluster features
    - using the CLI (command-line interface) 178
  - cluster time
    - using the CLI (command-line interface) 178
  - e-mail account 91, 92, 378, 379
  - features
    - using the CLI (command-line interface) 178
  - time
    - using the CLI (command-line interface) 178
  - traps 376
- settings
  - error notification 225
- shortcut keys 387
- shrinking
  - VDisks 149
- shutting down
  - clusters 165
- SNMP
  - setting up traps 376
- software
  - description 250, 358
  - installing 250
  - upgrading 243, 249
- software, upgrading
  - disruptive
    - using the CLI (command-line interface) 242
  - SAN Volume Controller 94
  - using the CLI (command-line interface) 241
- SSH (secure shell) 78
  - client system
    - issuing CLI commands from 174
    - overview 171
    - preparing to issue CLI commands 171, 172
  - configuring 80
  - creating 81
  - keys
    - generating 81
    - storing 160
  - resetting fingerprint 164
- starting
  - FlashCopy
    - consistency groups 136
    - mappings 135
  - IBM Director 88
  - Tivoli Storage Manager 85
- status
  - of node 13
- stopping
  - FlashCopy
    - mappings 135
  - Remote Copy
    - consistency groups 136

- storage controllers
  - adding
    - using the 266
    - using the CLI (command-line interface) 270
  - removing
    - using the 268
    - using the CLI (command-line interface) 271
- storing
  - public SSH keys 160
- strategy
  - software upgrade
    - using the CLI (command-line interface) 241
- support
  - configuring remote 86
  - Web sites xviii
- switches
  - operating over long distances 355
- synchronous copy
  - overview 45

## T

- text emphasis xv
- time
  - setting
    - using the CLI (command-line interface) 178
- Tivoli Storage Area Network Manager
  - starting 85
- trademarks 389
- truststore
  - certificate 74
- truststore certificate 74

## U

- uninterruptible power supply
  - overview 17
- upgrading software
  - disruptive
    - using the CLI (command-line interface) 242
  - SAN Volume Controller 94
  - strategy
    - using the CLI (command-line interface) 241
- using
  - object classes and instances 380

## V

- VDisks (virtual disks)
  - converting
    - from image mode to managed mode 151, 221
  - creating 127, 191
  - expanding 214
  - exposing LUNs 128
  - image mode 129
  - migrating 129, 220
  - migrating LUNs 130
  - shrinking 149
- viewing
  - clusters
    - feature logs 167, 228

- virtual disk-to-host mapping
  - description 30
- virtual disks (VDisks)
  - converting
    - from image mode to managed mode 151, 221
  - migrating 150
  - shrinking 149
- virtual network computing (VNC) server
  - downloading 87
- virtualization
  - asymmetric 7
  - overview 4
  - symmetric 8
- VNC (virtual network computing) server
  - downloading 87

## W

- Web sites xviii
- who should read this guide xiii
- Windows 2000
  - resolving boot problems 98

## Z

- zoning
  - considerations for Remote Copy 354
  - overview 351

---

# Readers' Comments — We'd Like to Hear from You

**IBM TotalStorage SAN Volume Controller  
Configuration Guide  
Version 1.2.1**

**Publication No. SC26-7543-03**

We appreciate your comments about this publication. Feel free to comment on specific errors or omissions, accuracy, organisation, subject matter, or completeness of this book. The comments you send should pertain to only the information in this manual and the way in which the information is presented.

For technical questions and information about products and prices, please contact your IBM branch office, your IBM business partner, or your authorized remarketer.

For general questions, please call "Hello IBM" (phone number 01803/313233).

When you send comments to IBM, you grant IBM a nonexclusive right to use or distribute your comments in any way it believes appropriate without incurring any obligation to you.

Comments:

Thank you for your support.

To submit your comments:

- Send your comments to the address on the reverse side of this form.

If you would like a response from IBM, please fill in the following information:

\_\_\_\_\_

Name

\_\_\_\_\_

Address

\_\_\_\_\_

Company or Organization

\_\_\_\_\_

Phone No.

\_\_\_\_\_

E-mail address



Fold and Tape

Please do not staple

Fold and Tape



NO POSTAGE  
NECESSARY  
IF MAILED IN THE  
UNITED STATES

# BUSINESS REPLY MAIL

FIRST-CLASS MAIL PERMIT NO. 40 ARMONK, NEW YORK

POSTAGE WILL BE PAID BY ADDRESSEE

International Business Machines Corporation  
Information Development  
Department 61C  
9032 South Rita Road  
Tucson, Arizona  
USA 85775-4401



Fold and Tape

Please do not staple

Fold and Tape





Part Number: 64P8259

Printed in USA

SC26-7543-03



(1P) P/N: 64P8259



Spine information:



IBM TotalStorage SAN Volume  
Controller

## SAN Volume Controller Configuration Guide

Version 1.2.1