

IBM System Storage SAN Volume Controller



Command-Line Interface User's Guide

Version 4.2.0

IBM System Storage SAN Volume Controller



Command-Line Interface User's Guide

Version 4.2.0

Note:

Before using this information and the product it supports, read the information in **Notices**.

This edition applies to the IBM System Storage SAN Volume Controller, release 4.2.0, and to all subsequent releases and modifications until otherwise indicated in new editions. This edition replaces SC26-7903-00 and all previous versions of SC26-7544.

© Copyright International Business Machines Corporation 2003, 2007. All rights reserved.

US Government Users Restricted Rights – Use, duplication or disclosure restricted by GSA ADP Schedule Contract with IBM Corp.

Contents

Tables	xvii	mkauth.	18
About this guide	xix	rmail.	19
Who should use this guide	xix	lsauth	20
Summary of Changes	xix	Chapter 6. E-Mail and inventory event	
Summary of changes for SC26-7903-01 SAN		notification commands.	23
Volume Controller Command-Line Interface		chemail.	23
Guide	xix	chemailuser	25
Summary of Changes for SC26-7903-00 SAN		lsemailuser	26
Volume Controller Command-Line Interface		mkemailuser	28
Guide	xxi	rmemailuser	29
Emphasis	xxii	sendinventoryemail.	30
SAN Volume Controller library and related		setemail	31
publications	xxii	startemail	32
Related Web sites	xxv	stopemail	32
How to order IBM publications	xxvi	testemail	33
How to send your comments	xxvi	Chapter 7. Cluster commands.	35
Syntax diagrams	xxvi	addnode	35
Terminology	xxviii	chcluster	38
CLI special characters	xxix	chiogrp.	40
Using wildcards in the SAN Volume Controller		chnode	41
CLI	xxix	clearumps	42
Data types and value ranges	xxx	cpdumps	44
CLI parameters	xxxvi	detectmdisk	45
CLI flags	xxxvi	rmnode.	46
CLI messages	xxxvii	setclustertime.	51
Chapter 1. Preparing the SSH client		setpwdreset	52
system	1	settimezone	53
Preparing the SSH client system to issue CLI		startstats	54
commands	2	stopcluster.	56
Chapter 2. Secure Shell	3	stopstats	58
Configuring a Secure Shell client system other than		Chapter 8. Backup and restore	
PuTTY	4	commands	59
Generating an SSH key pair using PuTTY	4	backup	59
Configuring the PuTTY session for the CLI	5	clear.	60
Adding subsequent SSH public keys to the SAN		help	60
Volume Controller	6	restore	61
Adding SSH keys for hosts other than the master		Chapter 9. Cluster diagnostic and	
console	7	service-aid commands	65
Chapter 3. Copying the SAN Volume		addnode	65
Controller software upgrade files using		applysoftware	67
PuTTY scp	9	cherrstate	69
Chapter 4. Audit log commands	11	clearerrlog.	70
catauditlog	11	dumpperlog	70
dumppauditlog	13	finderr	71
lsauditlogdumps.	14	rmnode.	72
Chapter 5. Role-based security		setevent	77
commands	17	setlocale	78
		svqueryclock	79
		writesernum	79

Chapter 10. Host commands	81	stopcrrelationship	156
addhostiogr	81	switchrconsistgrp	158
addhostport	82	switchrrelationship	159
chhost	83		
mkhost	85	Chapter 16. Migration commands . . .	161
rmhost	86	migrateexts	161
rmhostiogr	87	migratetoimage	163
rmhostport	89	migratevdisk	164
Chapter 11. Virtual disk commands . . .	91	Chapter 17. Tracing commands	167
chvdisk	91	setdisktrace	167
expandvdisksize	94	settrace	168
mkvdisk	96	starttrace	170
mkvdiskhostmap	100	stoptrace	171
rmvdisk	103		
rmvdiskhostmap	105	Chapter 18. Attributes of the	
shrinkvdisksize	106	-filtervalue argument	173
Chapter 12. Managed disk group		Chapter 19. Overview of the list dump	
commands	109	commands	179
addmdisk	109		
chmdiskgrp	110	Chapter 20. Information commands	181
mkmdiskgrp	110	caterrlog	181
rmmdisk	112	caterrlogbyseqnum	183
rmmdiskgrp	114	ls2145dumps	184
		lscopystatus	185
Chapter 13. Managed disk commands	117	lscluster	186
chmdisk	117	lsclustercandidate	189
includemdisk	117	lscontroller	191
setquorum	118	lsdiscoverystatus	193
		lserrlogbyfconsistgrp	195
Chapter 14. FlashCopy commands	121	lserrlogbyfcmap	196
chfconsistgrp	121	lserrlogbyhost	197
chfcmap	121	lserrlogbyiogrp	199
mkfconsistgrp	123	lserrlogbymdisk	200
mkfcmap	124	lserrlogbymdiskgroup	202
prestartfconsistgrp	126	lserrlogbynode	203
prestartfcmap	128	lserrlogbyrconsistgrp	205
rmfconsistgrp	129	lserrlogbyrrelationship	206
rmfcmap	130	lserrlogbyvdisk	207
startfconsistgrp	131	lserrlogdumps	209
startfcmap	133	lsfabric	210
stopfconsistgrp	134	lsfconsistgrp	212
stopfcmap	136	lsfcmap	214
		lsfcmapcandidate	217
Chapter 15. Metro Mirror and Global		lsfcmapprogress	218
Mirror commands	139	lsfcmapdependentmaps	219
chpartnership	139	lsfeaturedumps	220
chrconsistgrp	140	lsfreeextents	222
chrrelationship	140	lshbaportcandidate	223
mkpartnership	143	lshost	224
mkrconsistgrp	144	lshostiogr	227
mkrrelationship	145	lshostvdiskmap	228
rmpartnership	148	lsiogr	230
rmrconsistgrp	149	lsiogrphost	232
rmrrelationship	150	lsiogrcandidate	233
starttrconsistgrp	151	lsiostatsdumps	234
starttrrelationship	153	lsiotracedumps	235
stoptrconsistgrp	155	lslicense	236

lsmdisk	237
lsmdiskcandidate	241
lsmdiskextent	243
lsmdiskgrp	245
lsmdiskmember	247
lsmigrate	249
lsnode	250
lsnodecandidate	253
lsnodevpd	254
lsrconsistgrp	258
lsrrelationship	260
lsrrelationshipcandidate	263
lsrrelationshipprogress	265
lssoftware.dumps	266
lsshkeys	267
lstimezones	268
lsvdisk	269
lsvdiskextent	272
lsvdiskfc mappings	274
lsvdiskhostmap	275
lsvdiskmember	276
lsvdiskprogress	278
showtimezone	279

Chapter 21. Error log commands . . . 281

finderr	281
dumperrlog	281
clearerrlog	282
cherrstate	283
setevent	284

Chapter 22. Featurization commands 287

chlicense	287
dumpinternallog	288

Chapter 23. Secure Shell key commands 291

addsshkey	291
rmallsshkeys	292
rmsshkey	293

Chapter 24. Service mode commands 295

applysoftware	295
cleardumps	296
dumperrlog	298
exit	298

Chapter 25. Service mode information commands 301

ls2145dumps	301
lsclustervpd	302
lserrlogdumps	303
lsfeaturedumps	304
lsiostatsdumps	305
lsiotracedumps	306
lsnodes	307
lsnodevpd	308
lssoftware.dumps	311

Chapter 26. Controller command . . . 313

chcontroller	313
------------------------	-----

Chapter 27. Command-line interface messages 315

CMMVC5000I No message was found for major rc <i>MAJOR_RC</i> , minor rc <i>MINOR_RC</i> , for action/view id <i>ACTION_VIEW_ID</i>	315
CMMVC5700E The parameter list is not valid.	315
CMMVC5701E No object ID was specified.	315
CMMVC5702E [%1] is below the minimum level.	315
CMMVC5703E [%1] is above the maximum level.	316
CMMVC5704E [%1] is not divisible by the permitted step level.	316
CMMVC5705E A required parameter is missing.	316
CMMVC5706E An invalid argument has been entered for the [%1] parameter.	316
CMMVC5707E There are required parameters that are missing.	316
CMMVC5708E The %1 parameter is missing its associated arguments.	317
CMMVC5709E [%1] is not a supported parameter.	317
CMMVC5710E No self describing structure for identifier parameter [%1].	317
CMMVC5711E [%1] is not valid data.	317
CMMVC5712E Required data is missing.	317
CMMVC5713E There are some parameters which are mutually exclusive.	318
CMMVC5714E There are no items in the parameter list.	318
CMMVC5715E There is no parameter list.	318
CMMVC5716E Nonnumeric data was entered for a numeric field ([%1]). Enter a numeric value.. . . .	318
CMMVC5717E No match was found for the specified unit.	318
CMMVC5718E An unexpected return code was received.	319
CMMVC5719E A value of %2 requires the parameter %1 to be specified.	319
CMMVC5720E [%1] is not a valid argument for the -o parameter.	319
CMMVC5721E [%1] is not a valid time-stamp format. The valid format is MMDDHHmmYYYY.	319
CMMVC5722E [%1] is not a valid month.	319
CMMVC5723E [%1] is not a valid day.. . . .	320
CMMVC5724E [%1] is not a valid hour.	320
CMMVC5725E [%1] is not a valid minute.	320
CMMVC5726E [%1] are not valid seconds.	320
CMMVC5727E [%1] is not a valid filter.	320
CMMVC5728E [%1] should be in the format minute:hour:day:month:weekday..	321
CMMVC5729E One or more components in the list is not valid.	321
CMMVC5730E %1 is only valid when %2 has a value of %3.	321
CMMVC5731E %1 can only be entered when %2 has been entered.	321
CMMVC5732E The shared-memory interface is not available..	321

CMMVC5733E Enter at least one parameter.	322	CMMVC5762E The operation failed because the timeout period expired.	327
CMMVC5734E A combination of values was entered that is not valid.	322	CMMVC5763E The node failed to go online.	328
CMMVC5735E The name entered is not valid. Enter an alphanumeric string that does not start with a number.	322	CMMVC5764E The specified mode change is not valid..	328
CMMVC5736E -c is not a valid unit.	322	CMMVC5765E The select object is no longer a candidate. A change occurred during the request.	328
CMMVC5737E The parameter %1 has been entered multiple times. Enter the parameter once.	322	CMMVC5767E One or more of the specified parameters is not valid..	328
CMMVC5738E The name contains too many characters. Enter an alphanumeric string of 1 - 15 characters that is composed of any of the following characters: A - Z, a - z, 0 - 9, -, or _. The first character cannot be a number.	323	CMMVC5769E The operation requires that all nodes be online. One or more nodes are not online.	328
CMMVC5739E The argument %1 does not contain enough characters.	323	CMMVC5770E The file for the ssh key is not valid..	329
CMMVC5740E The filter flag %1 is not valid.	323	CMMVC5771E The operation failed because the object contains child objects. To complete the operation, specify the -force flag..	329
CMMVC5741E The filter value %1 is not valid..	323	CMMVC5772E The operation failed because a software upgrade is in progress..	329
CMMVC5742E A specified parameter is out of its valid range.	323	CMMVC5773E The operation failed because the selected object is in the wrong mode.	329
CMMVC5743E A specified parameter does not comply with the step value..	324	CMMVC5774E The userid is not valid..	329
CMMVC5744E Too many objects were specified in the command.	324	CMMVC5775E The directory attribute is not valid..	329
CMMVC5745E Not enough objects were specified in the command.	324	CMMVC5776E The directory listing could not be retrieved.	330
CMMVC5746E The operation that was requested is not valid for the this object.	324	CMMVC5777E The node was not added to the I/O group because the other node in the I/O Group is in the same power domain.	330
CMMVC5747E The operation that was requested is not valid.	324	CMMVC5778E The cluster was not created because one already exists..	330
CMMVC5748E The operation that was requested is not valid.	325	CMMVC5780E The action could not be completed using the Remote Cluster name. Use the Remote Cluster Unique ID instead.	330
CMMVC5749E The dump file name that was specified already exists.	325	CMMVC5781E The cluster ID specified is invalid..	330
CMMVC5750E The dump file was not created. The file system might be full..	325	CMMVC5782E The object is offline.	331
CMMVC5751E The dump file could not be written to disk..	325	CMMVC5783E The information is not available to complete this command.	331
CMMVC5752E The operation failed because the object contains child objects. Delete the child objects and then resubmit the request.	325	CMMVC5784E The cluster name is not unique. Specify the cluster using the cluster ID.	331
CMMVC5753E The specified object does not exist or is not a suitable candidate.	326	CMMVC5785E The filename contains an illegal character.	331
CMMVC5754E The specified object does not exist, or the name does not meet the naming rules..	326	CMMVC5786E The action failed because the cluster is not in a stable state.	331
CMMVC5755E The sizes of the specified objects do not match.	326	CMMVC5787E The cluster was not created because a cluster already exists.	332
CMMVC5756E The operation failed because the object is already mapped.	326	CMMVC5788E The service IP address is not valid..	332
CMMVC5757E The defaults for the self describing structure were not found.	326	CMMVC5789E The cluster was not modified because the IP address, subnet mask, service address, SNMP address, or gateway address is not valid.	332
CMMVC5758E The object filename already exists.	327	CMMVC5790E The node was not added to the cluster because the maximum number of nodes has been reached.	332
CMMVC5759E The memory cannot be allocated.	327	CMMVC5791E The action failed because an entity that was specified in the command does not exist.	333
CMMVC5760E The node could not be added to the cluster.	327		
CMMVC5761E The node could not be deleted from the cluster.	327		

CMMVC5792E The action failed because the I/O group is used for recovery.	333	CMMVC5811E The quorum index number for the managed disk (MDisk) was not set because the quorum disk does not exist.. . . .	338
CMMVC5793E The node was not added to the cluster because the I/O group already contains a pair of nodes.. . . .	333	CMMVC5812E The quorum index number for the managed disk (MDisk) was not set because the MDisk is in the wrong mode. Select an MDisk that has a mode of managed.. . . .	338
CMMVC5794E The action failed because the node is not a member of the cluster.	333	CMMVC5813E The quorum index number for the managed disk (MDisk) was not set because the MDisk has a sector size that is not valid.	338
CMMVC5795E The node was not deleted because a software upgrade is in progress.	333	CMMVC5814E The quorum index number for the managed disk (MDisk) was not set because the unique identifier (UID) type is not valid.	338
CMMVC5796E The action failed because the I/O group that the node belongs to is unstable.	334	CMMVC5815E The managed disk (MDisk) group was not created because an entity that was specified in the command does not exist.. . . .	339
CMMVC5797E The node was not deleted because this is the last node in the I/O group and there are virtual disks (VDisks) associated with the I/O group.. . . .	334	CMMVC5816E The action failed because an entity that was specified in the command does not exist.	339
CMMVC5798E The action failed because the node is offline..	334	CMMVC5817E The managed disk (MDisk) group was not renamed because the name was not valid..	339
CMMVC5799E The shut down was not successful because there is only one online node in the I/O group.	334	CMMVC5818E The managed disk (MDisk) group was not deleted because there is at least one MDisk in the group..	339
CMMVC5800E The action failed because an entity that was specified in the command does not exist.	335	CMMVC5819E The managed disk (MDisk) was not added to the MDisk group because the MDisk is part of another MDisk group.	340
CMMVC5801E The upgrade of the cluster software could not proceed because every node in the cluster must be online. Either delete the node that is offline or bring the node online and resubmit the command	335	CMMVC5820E The managed disk (MDisk) was not added to the MDisk group because an entity that was specified in the command does not exist..	340
CMMVC5802E The upgrade of the cluster software could not proceed because there is an I/O group in the cluster that contains only one node. The software upgrade requires that each node in an I/O group be shut down and restarted. If there is only one node in an I/O group, I/O operations could be lost if I/O operations are not stopped before beginning the software upgrade.	335	CMMVC5821E The managed disk (MDisk) was not added to the MDisk group because not enough MDisks were included in the list.	340
CMMVC5803E The entry in the error log was not marked because the sequence number was not found..	336	CMMVC5822E The managed disk (MDisk) was not added to the MDisk group because too many MDisks were included in the list.	340
CMMVC5804E The action failed because an entity that was specified in the command does not exist.	336	CMMVC5823E The managed disk (MDisk) was not deleted from the MDisk group because the MDisk is part of another MDisk group.	341
CMMVC5805E The progress information was not returned because the FlashCopy statistics are not ready yet..	336	CMMVC5824E The managed disk (MDisk) was not deleted from the MDisk group because it does not belong to the MDisk group..	341
CMMVC5806E The action failed because an entity that was specified in the command does not exist.	336	CMMVC5825E The managed disk (MDisk) was not deleted from the MDisk group because a virtual disk (VDisk) is allocated from one or more of the specified MDisks. A forced deletion is required.	341
CMMVC5807E The action failed because the managed disk (MDisk) cannot be changed to the specified mode.	337	CMMVC5826E The virtual disk (VDisk) was not created because an entity that was specified in the command does not exist..	341
CMMVC5808E The action failed because the managed disk (MDisk) does not exist.	337	CMMVC5827E The command failed as a result of an inconsistency between two or more of the entered parameters..	342
CMMVC5809E The tracing of I/O operations was not started because it is already in progress.	337	CMMVC5828E The virtual disk (VDisk) was not created because the I/O group contains no nodes..	342
CMMVC5810E The quorum index number for the managed disk (MDisk) was not set because the MDisk is offline.	337		

CMMVC5829E The image-mode or sequential-mode virtual disk (VDisk) was not created because more than one managed disk (MDisk) is specified.	342	CMMVC5848E The action failed because the virtual disk (VDisk) does not exist or it is being deleted..	347
CMMVC5830E The image-mode virtual disk (VDisk) was not created because no managed disk (MDisk) was specified in the command.	342	CMMVC5849E The migration failed because some or all of the extents are already being migrated.	347
CMMVC5831E The virtual disk (VDisk) was not created because the preferred node for I/O operations is not part of the I/O group.	343	CMMVC5850E The extent was not migrated because there is a problem with the source extents.	347
CMMVC5832E The property of the virtual disk (VDisk) was not modified because an entity that was specified in the command does not exist..	343	CMMVC5851E The extent was not migrated because there is a problem with the target extents.	347
CMMVC5833E The property of the virtual disk (VDisk) was not modified because there are no nodes in the I/O group.	343	CMMVC5852E The migration failed because there are too many migrations in progress.	348
CMMVC5834E The I/O group for the virtual disk (VDisk) was not modified because the group is a recovery I/O group. To modify the I/O group, use the force option.	343	CMMVC5853E The action failed because there was a problem with the MDisk group.	348
CMMVC5835E The virtual disk (VDisk) was not expanded because an entity that was specified in the command does not exist..	344	CMMVC5854E The extent information was not returned because the extent is not used or does not exist.	348
CMMVC5836E The virtual disk (VDisk) was not shrunk because it is locked.	344	CMMVC5855E The extent information was not returned because the managed disk (MDisk) is not used by any virtual disk (VDisk).	348
CMMVC5837E The action failed because the virtual disk (VDisk) is part of a FlashCopy mapping.	344	CMMVC5856E The action failed because the virtual disk (VDisk) does not belong to the specified managed disk (MDisk) group.	349
CMMVC5838E The action failed because the virtual disk (VDisk) is part of a Metro Mirror mapping.	344	CMMVC5857E The action failed because the managed disk (MDisk) does not exist or it is not a member of the managed disk (MDisk) group..	349
CMMVC5839E The virtual disk (VDisk) was not shrunk because an entity that was specified in the command does not exist..	345	CMMVC5858E The action failed because the virtual disk (VDisk) is in the wrong mode, the managed disk (MDisk) is in the wrong mode, or both are in the wrong mode..	349
CMMVC5840E The virtual disk (VDisk) was not deleted because it is mapped to a host or because it is part of a FlashCopy or Metro Mirror mapping.	345	CMMVC5859E The migration did not complete because an error occurred during the migration of the last extent on an image-mode virtual disk (VDisk).	349
CMMVC5841E The virtual disk (VDisk) was not deleted because it does not exist.	345	CMMVC5860E The action failed because there were not enough extents in the managed disk (MDisk) group..	350
CMMVC5842E The action failed because an entity that was specified in the command does not exist.	345	CMMVC5861E The action failed because there were not enough extents on the managed disk (MDisk)..	350
CMMVC5843E The virtual disk (VDisk)-to-host mapping was not created because the VDisk does not have a capacity greater than zero bytes.	346	CMMVC5862E The action failed because the virtual disk (VDisk) is being formatted.	350
CMMVC5844E The virtual disk (VDisk)-to-host mapping was not created because the SCSI logical unit number (LUN) ID is not valid.	346	CMMVC5863E The migration failed because there are not enough free extents on the target managed disk (MDisk).	350
CMMVC5845E The extent was not migrated because an entity that was specified in the command does not exist.	346	CMMVC5864E The extent information was not returned because the source extent is not used.	351
CMMVC5846E The virtual disk (VDisk) was not migrated because an entity that was specified in the command does not exist..	346	CMMVC5865E The extent information was not returned because the extent is out of range for the managed disk (MDisk) or virtual disk (VDisk)..	351
CMMVC5847E The virtual disk (VDisk) was not migrated because its associated managed disk (MDisk) is already in the MDisk group..	347	CMMVC5866E The extent was not migrated because the extent contains internal data.	351
		CMMVC5867E The action failed because the worldwide port name is already assigned or is not valid.	351

CMMVC5868E The action failed because an entity that was specified in the command does not exist.	352	CMMVC5888E The action failed because an entity that was specified in the command does not exist.	356
CMMVC5869E The host object was not renamed because the host ID or name is not valid.	352	CMMVC5889E The FlashCopy mapping was not deleted because an entity that was specified in the command does not exist..	357
CMMVC5870E The host object was not deleted because an entity that was specified in the command does not exist.	352	CMMVC5890E The FlashCopy mapping or consistency group was not started because starting consistency group 0 is not a valid operation.	357
CMMVC5871E The action failed because one or more of the configured worldwide port names is in a mapping.	352	CMMVC5891E The FlashCopy consistency group was not created because the name is not valid..	357
CMMVC5872E The worldwide port name (WWPN) was not added to the host object because an entity that was specified in the command does not exist.	353	CMMVC5892E The FlashCopy consistency group was not created because it already exists.	357
CMMVC5873E The action failed because there is no matching worldwide port name (WWPN).	353	CMMVC5893E The action failed because an entity that was specified in the command does not exist.	358
CMMVC5874E The action failed because the host does not exist.	353	CMMVC5894E The FlashCopy consistency group was not deleted because you are trying to delete consistency group 0 or the name of the consistency group is not valid.	358
CMMVC5875E The action failed because the virtual disk (VDisk) does not exist.	353	CMMVC5895E The FlashCopy consistency group was not deleted because it contains mappings. To delete this consistency group, a forced deletion is required.	358
CMMVC5876E The virtual disk (VDisk)-to-host mapping was not created because the maximum number of mappings has been reached.	353	CMMVC5896E The FlashCopy mapping was not deleted because the mapping or consistency group is in the preparing state. The mapping or consistency group must be stopped first..	358
CMMVC5877E The virtual disk (VDisk)-to-host mapping was not created because the maximum number of SCSI LUNs has been allocated.	354	CMMVC5897E The FlashCopy mapping was not deleted because the mapping or consistency group is in the prepared state. The mapping or consistency group must be stopped first.	359
CMMVC5878E The virtual disk (VDisk)-to-host mapping was not created because this VDisk is already mapped to this host.	354	CMMVC5898E The FlashCopy mapping was not deleted because the mapping or consistency group is in the copying state. The mapping or consistency group must be stopped first.	359
CMMVC5879E The virtual disk-to-host mapping was not created because this SCSI LUN is already assigned to another mapping.	354	CMMVC5899E The FlashCopy mapping was not deleted because the mapping or consistency group is in the stopped state. To delete the mapping, a forced deletion is required.	359
CMMVC5880E The virtual disk (VDisk)-to-host mapping was not created because the VDisk has a capacity of zero bytes.	354	CMMVC5900E The FlashCopy mapping was not deleted because the mapping or consistency group is in the suspended state. The mapping or consistency group must be stopped first..	359
CMMVC5881E The FlashCopy mapping was not created because an entity that was specified in the command does not exist..	355	CMMVC5901E The FlashCopy mapping was not prepared because the mapping or consistency group is already in the preparing state..	360
CMMVC5882E The FlashCopy mapping was not created because a mapping for the source or target virtual disk (VDisk) already exists..	355	CMMVC5902E The FlashCopy mapping was not prepared because the mapping or consistency group is already in the prepared state.	360
CMMVC5883E The FlashCopy mapping was not created because the recovery I/O group is associated with the source or target virtual disk (VDisk).	355	CMMVC5903E The FlashCopy mapping was not prepared because the mapping or consistency group is already in the copying state..	360
CMMVC5884E The FlashCopy mapping was not created because the source or target virtual disk (VDisk) cannot be a member of a Metro Mirror mapping.	355	CMMVC5904E The FlashCopy mapping was not prepared because the mapping or consistency group is already in the suspended state..	360
CMMVC5885E The FlashCopy mapping was not created because this source or target virtual disk (VDisk) cannot be a member of a FlashCopy mapping.	356		
CMMVC5886E The FlashCopy mapping was not created because the source or target virtual disk (VDisk) is associated with the recovery I/O group.	356		
CMMVC5887E The FlashCopy mapping was not created because the source or target virtual disk (VDisk) must not be in router mode.	356		

CMMVC5905E The FlashCopy mapping or consistency group was not started because the mapping or consistency group is in the idle state. The mapping or consistency group must be prepared first.	361	CMMVC5921E The properties of the FlashCopy mapping were not modified because the consistency group is not idle.. . . .	364
CMMVC5906E The FlashCopy mapping or consistency group was not started because the mapping or consistency group is in the preparing state.. . . .	361	CMMVC5922E The FlashCopy mapping was not created because the destination virtual disk (Vdisk) is too small.. . . .	365
CMMVC5907E The FlashCopy mapping or consistency group was not started because the mapping or consistency group is already in the copying state.. . . .	361	CMMVC5923E The FlashCopy mapping was not created because the I/O group is offline. . . .	365
CMMVC5908E The FlashCopy mapping or consistency group was not started because the mapping or consistency group is in the stopped state. The mapping or consistency group must be prepared first.	361	CMMVC5924E The FlashCopy mapping was not created because the source and target virtual disks (VDisks) are different sizes.. . . .	365
CMMVC5909E The FlashCopy mapping or consistency group was not started because the mapping or consistency group is in the suspended state.. . . .	362	CMMVC5925E The remote cluster partnership was not created because it already exists. . . .	365
CMMVC5910E The FlashCopy mapping or consistency group was not stopped because the mapping or consistency group is in the idle state.. . . .	362	CMMVC5926E The remote cluster partnership was not created because there are too many partnerships.	366
CMMVC5911E The FlashCopy mapping or consistency group was not stopped because the mapping or consistency group is in the preparing state.. . . .	362	CMMVC5927E The action failed because the cluster ID is not valid.. . . .	366
CMMVC5912E The FlashCopy mapping or consistency group was not stopped because the mapping or consistency group is already in the stopped state.. . . .	362	CMMVC5928E The action failed because the cluster name is a duplicate of another cluster.. . . .	366
CMMVC5913E The properties of the FlashCopy mapping were not modified because the mapping or consistency group is in the preparing state.. . . .	363	CMMVC5929E The Metro Mirror partnership was not deleted because it has already been deleted.. . . .	366
CMMVC5914E The properties of the FlashCopy mapping were not modified because the mapping or consistency group is in the prepared state..	363	CMMVC5930E The Metro Mirror relationship was not created because an entity that was specified in the command does not exist.. . . .	366
CMMVC5915E The properties of the FlashCopy mapping were not modified because the mapping or consistency group is in the copying state. . . .	363	CMMVC5931E The Metro Mirror relationship was not created because the master or auxiliary virtual disk (Vdisk) is locked. . . .	367
CMMVC5916E The properties of the FlashCopy mapping were not modified because the mapping or consistency group is in the suspended state.. . . .	363	CMMVC5932E The Metro Mirror relationship was not created because the master or auxiliary virtual disk (Vdisk) is a member of a FlashCopy mapping.	367
CMMVC5917E The FlashCopy mapping was not created because there is no memory to create the bitmap.. . . .	364	CMMVC5933E The Metro Mirror relationship was not created because the master or auxiliary virtual disk (Vdisk) is in the recovery I/O group.. . . .	367
CMMVC5918E The FlashCopy mapping was not prepared because the I/O group is offline. . . .	364	CMMVC5934E The Metro Mirror relationship was not created because the master or auxiliary virtual disk (Vdisk) is in the router mode.	367
CMMVC5919E The FlashCopy mapping or consistency group was not started because the I/O group is offline.	364	CMMVC5935E The action failed because an entity that was specified in the command does not exist.	368
CMMVC5920E The FlashCopy mapping was not created because the consistency group is not idle.	364	CMMVC5936E The action failed because an entity that was specified in the command does not exist.	368
		CMMVC5937E The action failed because an entity that was specified in the command does not exist.	368
		CMMVC5938E The Metro Mirror consistency group was not deleted because the consistency group contains relationships. To delete the consistency group, the force option is required.	368
		CMMVC5939E The action failed because the cluster is not in a stable state.	369
		CMMVC5940E The cluster that contains the auxiliary virtual disk (Vdisk) is unknown. . . .	369

CMMVC5941E The cluster that contains the master virtual disk (Vdisk) has too many consistency groups.	369	CMMVC5969E The Metro Mirror relationship was not created because the I/O group is offline.	375
CMMVC5942E The cluster that contains the auxiliary virtual disk (Vdisk) has too many consistency groups.	369	CMMVC5970E The Metro Mirror relationship was not created because there is not enough memory.	375
CMMVC5943E The specified relationship is not valid.	369	CMMVC5971E The operation was not performed because the consistency group contains no relationships.	375
CMMVC5944E The specified consistency group is not valid.	370	CMMVC5972E The operation was not performed because the consistency group contains relationships.	375
CMMVC5945E The specified master cluster is not valid.	370	CMMVC5973E The operation was not performed because the consistency group is not synchronized.	376
CMMVC5946E The specified auxiliary cluster is not valid.	370	CMMVC5974E The operation was not performed because the consistency group is offline.	376
CMMVC5947E The specified master virtual disk (Vdisk) is not valid.	370	CMMVC5975E The operation was not performed because the cluster partnership is not connected.	376
CMMVC5948E The specified auxiliary virtual disk (Vdisk) is not valid.	370	CMMVC5976E The operation was not performed because the consistency group is in the freezing state.	376
CMMVC5949E The specified relationship is unknown.	371	CMMVC5977E The operation was not performed because it is not valid given the current consistency group state.	376
CMMVC5950E The specified consistency group is unknown.	371	CMMVC5978E The operation was not performed because the relationship is not synchronized.	377
CMMVC5951E The operation cannot be performed because the relationship is not a stand-alone one.	371	CMMVC5980E The operation was not performed because the master and auxiliary clusters are not connected.	377
CMMVC5952E The relationship and consistency group have different master clusters.	371	CMMVC5981E The operation was not performed because the relationship is in the freezing state.	377
CMMVC5953E The relationship and group have different auxiliary clusters.	371	CMMVC5982E The operation was not performed because it is not valid given the current relationship state.	377
CMMVC5954E The master and auxiliary virtual disks (VDisks) are different sizes.	372	CMMVC5983E The dump file was not created. The file system might be full.	378
CMMVC5955E The maximum number of relationships has been reached.	372	CMMVC5984E The dump file was not written to disk. The file system might be full.	378
CMMVC5956E The maximum number of consistency groups has been reached.	372	CMMVC5985E The action failed because the directory that was specified was not one of the following directories: /dumps, /dumps/iostats, /dumps/iotrace, /dumps/feature, /dumps/configs, /dumps/elogs, or /home/admin/upgrade.	378
CMMVC5957E The master virtual disk (Vdisk) is already in a relationship.	372	CMMVC5986E The tracing of I/O operations was not started because the virtual disk (Vdisk) or managed disk (Mdisk) failed to return statistics.	378
CMMVC5958E The auxiliary virtual disk (Vdisk) is already in a relationship.	372	CMMVC5987E Address is not valid.	379
CMMVC5959E There is a relationship that already has this name on the master cluster.	373	CMMVC5988E This command should not be issued if you are logged in with a root user ID. Use the admin userid.	379
CMMVC5960E There is a relationship that already has this name on the auxiliary cluster.	373	CMMVC5989E The operation was not performed because the relationship is offline.	379
CMMVC5961E There is a consistency group that already has this name on the master cluster.	373	CMMVC5990E The FlashCopy consistency group was not stopped as there are no FlashCopy mappings within the group.	379
CMMVC5962E There is a consistency group that already has this name on the auxiliary cluster.	373		
CMMVC5963E No direction has been defined.	373		
CMMVC5964E The copy priority is not valid.	374		
CMMVC5965E The virtual disks (VDisks) are in different I/O groups on the local cluster.	374		
CMMVC5966E The master virtual disk (Vdisk) is unknown.	374		
CMMVC5967E The auxiliary virtual disk (Vdisk) is unknown.	374		
CMMVC5968E The relationship cannot be added because the states of the relationship and the consistency group do not match.	374		

CMMVC5991E The FlashCopy consistency group was not stopped as there are no FlashCopy mappings within the group.	380	CMMVC6015E A delete request is already in progress for this object.	385
CMMVC5992E The Metro Mirror consistency group was not stopped as there are no Metro Mirror relationships within the group.. . . .	380	CMMVC6016E The action failed as there would be, or are, no more disks in the MDisk group.	385
CMMVC5993E The specific upgrade package does not exist.	380	CMMVC6017E A parameter or argument contains invalid characters. Ensure that all characters are ASCII.	386
CMMVC5994E Error in verifying the signature of the upgrade package.	380	CMMVC6018E The software upgrade pre-install process failed.	386
CMMVC5995E An error when the system was unpacking the upgrade package..	381	CMMVC6019E The software upgrade failed as a node pended as the upgrade was in progress.. . . .	386
CMMVC5996E The specific upgrade package cannot be installed over the current version.	381	CMMVC6020E The software upgrade failed as the system was unable to distribute the software package to all nodes..	386
CMMVC5997E The action failed because the capacity of the MDisk is smaller than the extent size of the MDisk group.	381	CMMVC6021E The system is currently busy performing another request. Try again later.	386
CMMVC5998W The virtualized storage capacity exceeds the amount that is licensed. Nevertheless, the requested action was completed.	381	CMMVC6022E The system is currently busy performing another request. Please try again later..	387
CMMVC5999W Featurization for this facility has not been enabled.	382	CMMVC6023E The system is currently busy performing another request. Please try again later..	387
CMMVC6000W Featurization for this facility has not been enabled.	382	CMMVC6024E The auxiliary VDisk entered is invalid.	387
CMMVC6001E The FlashCopy consistency group was not started as there are no FlashCopy mappings within the group.	382	CMMVC6025E The RC consistency group Master cluster is not the local cluster.	387
CMMVC6002E This command can only be run on a node that is in service mode.	382	CMMVC6026E The Metro Mirror consistency group is not in the stopped state.	388
CMMVC6003E This command can not be run on a node that is in service mode.	382	CMMVC6027E The RC consistency group is not the primary master..	388
CMMVC6004E The delimiter value, %1, is invalid.	383	CMMVC6028E This upgrade package cannot be applied to the current software level because it contains changes to the cluster state and there are remote cluster partnership defined.	388
CMMVC6005E The view request failed as the specified object is not a member of an appropriate group.	383	CMMVC6029E All nodes must have identical code level before a concurrent code upgrade can be performed.	388
CMMVC6006E The managed disk (MDisk) was not deleted because the resource was busy.. . . .	383	CMMVC6030E The operation was not preformed because the FlashCopy mapping is part of a consistency group. The action must be performed at the consistency group level.	389
CMMVC6007E The two passwords that were entered do not match.	383	CMMVC6031E The operation was not performed because the FlashCopy consistency group is empty..	389
CMMVC6008E The key already exists.	383	CMMVC6032E The operation was not performed because one or more of the entered parameters is invalid for this operation..	389
CMMVC6009E Unable to malloc a block of memory in which to copy the returned data.	384	CMMVC6033E The action failed due to an internal error.	389
CMMVC6010E Unable to complete the command as there are insufficient free extents.	384	CMMVC6034E The action failed because the maximum number of objects has been reached.. . . .	389
CMMVC6011E At least one remote cluster partnership has been found. This upgrade package cannot be applied to the current code level until all remote cluster partnerships are deleted.	384	CMMVC6035E The action failed as the object already exists.	390
CMMVC6012W The virtualized storage capacity is approaching the amount that is licensed.	384	CMMVC6036E An invalid action was requested.	390
CMMVC6013E The command failed because there is a consistency group mismatch on the aux cluster.	385	CMMVC6037E The action failed as the object is not empty.	390
CMMVC6014E The command failed because the requested object is either unavailable or does not exist.	385	CMMVC6038E The action failed as the object is empty.	390
		CMMVC6039E The action failed as the object is not a member of a group..	390

CMMVC6040E The action failed as the object is not a parent.	391
CMMVC6041E The action failed as the cluster is full.	391
CMMVC6042E The action failed as the object is not a cluster member.	391
CMMVC6043E The action failed as the object is a member of a group.	391
CMMVC6044E The action failed as the object is a parent.	391
CMMVC6045E The action failed, as the -force flag was not entered.	392
CMMVC6046E The action failed as too many candidates were selected.	392
CMMVC6047E The action failed as too few candidates were selected.	392
CMMVC6048E The action failed as the object is busy.	392
CMMVC6049E The action failed as the object is not ready.	392
CMMVC6050E The action failed as the command was busy.	393
CMMVC6051E An unsupported action was selected.	393
CMMVC6052E The action failed as the object is a member of a Flash Copy mapping.	393
CMMVC6053E An invalid WWPN was entered.	393
CMMVC6054E The action failed as not all nodes are online.	393
CMMVC6055E The action failed as an upgrade is in progress.	394
CMMVC6056E The action failed as the object is too small.	394
CMMVC6057E The action failed as the object is the target of a Flash Copy mapping.	394
CMMVC6058E The action failed as the object is in the recovery HWS.	394
CMMVC6059E The action failed as the object is in an invalid mode.	394
CMMVC6060E The action failed as the object is being deleted.	395
CMMVC6061E The action failed as the object is being resized.	395
CMMVC6062E The action failed as the object is being moved between HWS.	395
CMMVC6063E The action failed as there are no more disks in the group.	395
CMMVC6064E The action failed as the object has an invalid name.	395
CMMVC6065E The action failed as the object is not in a group.	396
CMMVC6066E The action failed as the system is running low on memory.	396
CMMVC6067E The action failed as the SSH key was not found.	396
CMMVC6068E The action failed as there are no free SSH keys.	396
CMMVC6069E The action failed as the SSH key is already registered.	396

CMMVC6070E An invalid or duplicated parameter, unaccompanied argument, or incorrect argument sequence has been detected. Ensure that the input is as per the help.	397
CMMVC6071E The virtual disk is already mapped to a host. To create additional virtual disk-to-host mappings, you must use the command-line interface.	397
CMMVC6073E The maximum number of files has been exceeded.	397
CMMVC6074E The command failed as the extent has already been assigned.	397
CMMVC6075E The expand failed as the last extent is not a complete extent.	397
CMMVC6076E The command failed due to an error during the flushing of the VDisk.	398
CMMVC6077E WARNING - Unfixed errors should be fixed before applying software upgrade. Depending on the nature of the errors, they might cause the upgrade process to fail. It is highly recommended to fix these errors before proceeding. If a particular error cannot be fixed, contact the support center.	398
CMMVC6078E The action failed because the object is in an invalid mode.	398
CMMVC6079E Metadata recovery could not complete the operation because a parameter is invalid.	398
CMMVC6081E Metadata Recovery is busy processing the previous operation.	399
CMMVC6082E The attempt to abort metadata recovery failed because the previous operation has completed.	399
CMMVC6083E Metadata recovery could not find a valid dumpfile required for the rebuild operation.	399
CMMVC6084E Metadata recovery could not create/open/write the scan file, the disk might be full.	399
CMMVC6085E Metadata recovery could not create/open/write the dump file, the disk might be full.	399
CMMVC6086E Metadata recovery could not create/open/write the progress file, the disk might be full.	399
CMMVC6087E Metadata recovery could not map the buffers necessary to complete the operation.	400
CMMVC6088E The lba at which metadata recovery was requested does not contain metadata.	400
CMMVC6089E The metadata at the requested lba is flagged as invalid.	400
CMMVC6090E The metadata header checksum verification failed.	400
CMMVC6091E The metadata region checksum verification failed.	400
CMMVC6092E The metadata recovery operation was aborted.	400
CMMVC6093E Metadata recovery internal error - (read only)	400

CMMVC6095E Metadata recovery encountered the end of the disk.	400	CMMVC6132E An object of a given type has a property with an incorrect value. The operation cannot proceed until the property has the correct value. Take administrative action to change the value and try again.	408
CMMVC6096E Metadata recovery encountered an error from a lower layer - (v1 no resource).	401	CMMVC6133E Required type property property not found	408
CMMVC6097E Metadata recovery encountered an error from a lower layer - (v1 failure).	401	CMMVC6134E No argument for -option	408
CMMVC6098E The copy failed as the specified node is the configuration node.	401	CMMVC6135E Argument value for -option is not valid	408
CMMVC6100E -option not consistent with action.	401	CMMVC6136W No SSH key file file-name	408
CMMVC6101E -option not consistent with -option	401	CMMVC6137W No SSH key file file-name; key not restored	409
CMMVC6102E -option and -option are alternatives	401	CMMVC6138E -option is required	409
CMMVC6103E Problem with file-name: details	402	CMMVC6139E Incorrect XML tag nesting in filename	409
CMMVC6104E Action name not run	402	CMMVC6140E No default name for type type	409
CMMVC6105E Different names for source (name) and target (name) clusters	402	CMMVC6141E -option does not contain any argument	409
CMMVC6106W Target cluster has non-default id_alias alias.	402	CMMVC6142E Existing object-type object-name has a non-default name.	410
CMMVC6107E x io_grp objects in target cluster; y are required	402	CMMVC6143E Required configuration file file-name does not exist	410
CMMVC6108I Disk controller system with a WWNN of wwnn found.	403	CMMVC6144W Object with default name name restored as substitute-name.	410
CMMVC6109E Disk controller system with a WWNN of wwnn not available.	403	CMMVC6145I Use the restore -prepare command first	410
CMMVC6110E Bad code level	403	CMMVC6146E Problem parsing object-type data: line	411
CMMVC6111E Cluster code_level could not be determined from level	403	CMMVC6147E type name has a name beginning with prefix.	411
CMMVC6112W object-type object-name has a default name	403	CMMVC6148E Target cluster has n-actual objects of type type instead of n-required	411
CMMVC6113E Command failed with return code: details	404	CMMVC6149E An action is required.	411
CMMVC6114E No help for action action.	404	CMMVC6150E The action, action, is not valid	411
CMMVC6115W Feature property mismatch: value1 expected; value2 found	404	CMMVC6151E The -option option is not valid	412
CMMVC6116I Feature match or property	404	CMMVC6152E vdisk name instance number instance is not valid	412
CMMVC6117E fix-or-feature is not available	404	CMMVC6153E object not consistent with action.	412
CMMVC6118I type with property value [and property value] found	405	CMMVC6154E Required object-type property property-name has a null value.	412
CMMVC6119E type with property value [and property value] not found	405	CMMVC6155I SVCCONFIG processing completed successfully	412
CMMVC6120E Target is not the configuration node	405	CMMVC6156W SVCCONFIG processing completed with errors	413
CMMVC6121E No cluster id or id_alias in backup configuration	405	CMMVC6164E The SVCCONFIG CRON job, which runs overnight on a daily overnight, has failed.	413
CMMVC6122E No type with property value present in table.	405	CMMVC6165E Target is not the original configuration node with WWNN of value.	413
CMMVC6123E No property for type name	406	CMMVC6166E A property of an object has changed during svcconfig restore -execute.	413
CMMVC6124E No type with property value	406	CMMVC6181E The target cluster contains an object that has a counterpart in the configuration to be restored, and has the correct ID.	414
CMMVC6125E No unique ID for type name	406	CMMVC6182W An object that does not contribute to the fabric of the configuration cannot be restored because its configuration does not permit it to be created.	414
CMMVC6126E No type with unique ID value	406		
CMMVC6127I SSH key identifier for user already defined; will not be restored	406		
CMMVC6128W details.	407		
CMMVC6129E vdisk-to-host map objects have vdisk_UID values that are not consistent.	407		
CMMVC6130W Inter-cluster property will not be restored.	407		
CMMVC6131E No location cluster information	407		

CMMVC6186W An IO group was restored with a different ID value.	414	CMMVC6220E The maximum number of hosts for one or more IO groups is already configured.	419
CMMVC6200E The action failed because of incompatible software.	414	CMMVC6221E The maximum number of WWPNs for one or more IO groups is already configured.	419
CMMVC6201E The node could not be added, because of incompatible software: status code <i>STATUS_CODE</i>	415	CMMVC6222E The maximum number of WWPNs for the host is already configured.	420
CMMVC6202E The cluster was not modified because the IP address is not valid.	415	CMMVC6223E The host does not belong to one or more of the IO groups specified or inferred.	420
CMMVC6203E The action failed because the directory that was specified was not one of the following directories: /dumps, /dumps/iostats, /dumps/iotrace, /dumps/feature, /dumps/config, /dumps/elogs, /dumps/ec or /dumps/pl.	415	CMMVC6224E The host already belongs to one or more of the IO groups specified.	420
CMMVC6204E The action failed as the resulting disk size would be less than, or equal to, zero.	415	CMMVC6225E An IO group cannot be removed from a host because of one or more associated vdisks.	420
CMMVC6205E Metadata recovery can not use the provided mdisk id - invalid or destroyed.	416	CMMVC6226E The action was not completed because the cluster has reached the maximum number of extents in MDisk Groups.	421
CMMVC6206E The software upgrade failed as a file containing the software for the specified MCP version was not found.	416	CMMVC6227I The package installed successfully.	421
CMMVC6207E The action failed because the virtual disk (Vdisk) is part of a Metro Mirror mapping.	416	CMMVC6228E The cluster was recovered and the CLI functionality is limited until the cause of the failure is determined and any corrective action taken.	421
CMMVC6208E The action failed because the virtual disk (Vdisk) is part of a FlashCopy mapping.	416	CMMVC6229E The action failed as the SSH key has been revoked.	421
CMMVC6209E The FlashCopy mapping or consistency group could not be started in a reasonable time. The mapping or group is instead being prepared.	416	CMMVC6230E The action failed as the SSH key index (SSH_LABEL_ID) is invalid.	421
CMMVC6210E The command failed as a result of a migrated disk IO medium error.	417	CMMVC6231E The action failed as the audit table is full.	421
CMMVC6211E The command failed as a migrate to image was in progress.	417	CMMVC6232E This operation cannot be performed because the cluster is currently aborting the previous software upgrade command.	422
CMMVC6212E The command failed because data in the cache has not been committed to disk.	417	CMMVC6233E This operation cannot be performed because, either a software upgrade has not been started, or a software upgrade is in progress but is not in a state where it can be aborted.	422
CMMVC6213E You are trying to recover region data that was created by a code level different from the one you are currently running on the node.	417	CMMVC6234E The upgrade cannot be aborted because at least one node has already committed to a new code level.	422
CMMVC6214E Failed to recreate the cluster you are trying to rebuild.	417	CMMVC6235E An invalid response has been entered. The command has not been executed. Input is case sensitive. Enter either yes or no.	422
CMMVC6215E The FlashCopy mapping was not created or modified because the consistency group already contains the maximum number of mappings.	418	CMMVC6236E The command has not completed. A limited availability parameter has been entered without the required environment setting being set.	423
CMMVC6216E The Metro Mirror relationship was not created because the master or auxiliary virtual disk (Vdisk) is a member of a Metro Mirror mapping.	418	CMMVC6237E The command failed as the remote cluster does not support global mirror.	423
CMMVC6217E The maximum number of hosts for the cluster is already configured.	418	CMMVC6238E The copy type differs from other copies already in the consistency group.	423
CMMVC6218E The maximum number of host/IO group pairs for the cluster is already configured.	418	CMMVC6239E The FlashCopy mapping was not prepared because the mapping or consistency group is in the stopping state.	423
CMMVC6219E The maximum number of WWPNs for the cluster is already configured.	419	CMMVC6240E The properties of the FlashCopy mapping were not modified because the mapping or consistency group is in the stopping state.	423

CMMVC6241E The FlashCopy mapping was not deleted because the mapping or consistency group is in the stopping state. The mapping or consistency group must be stopped first.	424
CMMVC6242E The FlashCopy mapping or consistency group was not started because the mapping or consistency group is in the stopping state.	424
CMMVC6243E The FlashCopy mapping or consistency group was not stopped because the mapping or consistency group is already in the stopping state.	424
CMMVC6244E The FlashCopy mapping was not created because the source virtual disk (Vdisk) cannot be the target for a FlashCopy mapping.	425
CMMVC6245E The FlashCopy mapping was not created because the source virtual disk (Vdisk) is already in the maximum number of FlashCopy mappings.	425
CMMVC6246E The FlashCopy mapping was not created because the target virtual disk (Vdisk) is already a source vdisk in a FlashCopy mapping.	425
CMMVC6247E The FlashCopy mapping was not created because the target virtual disk (Vdisk) is already a target vdisk in a FlashCopy mapping.	426
CMMVC6248E The command failed because the authorization table is full.	426
CMMVC6249E The command failed because the authorization record was not found or is already set to the default role.	426
CMMVC6250E The command failed because the authorization record is not set to the default role. Use rmath to set the default role.	426
CMMVC6251E The command failed because the specified role was not found.	426

CMMVC6252E The command failed authorization because the session ssh key is invalid or was deleted.	427
CMMVC6253E The command failed authorization because the session ssh key does not have the requisite role.	427
CMMVC6254E The command failed because the specified ssh key was not found. NOTE This command must specify an admin key.	427
CMMVC6255E The command can not set the authorization record to the default role. Use rmath to set the default role.	427
CMMVC6263E The command failed because the ssh key already exists or there is a duplicate ssh key.	427
CMMVC6500E The action failed because the source and destination vdisk are the same.	428
CMMVC6501E The action failed because the node hardware is incompatible with the current I/O group member.	428
CMMVC6502E The FlashCopy mapping was not prepared because preparing consistency group 0 is not a valid operation.	428
CMMVC6503E The FlashCopy mapping or consistency group was not stopped because starting consistency group 0 is not a valid operation.	428

Accessibility 429

Notices 431

Trademarks 433

Glossary 435

Index 445

Tables

1. Valid filter attributes	173
--------------------------------------	-----

About this guide

The IBM System Storage SAN Volume Controller: Command-Line Interface (CLI) User's Guide provides information that helps you configure and use the IBM System Storage SAN Volume Controller.

Who should use this guide

This guide is intended for system administrators or others who install and use the SAN Volume Controller.

Before using the SAN Volume Controller, you should have an understanding of storage area networks (SANs), the storage requirements of your enterprise, and the capabilities of your storage units.

Before creating or modifying a new Mirror relationship between two virtual disks (VDisks), review this guide and note the details with respect to the copy of the *IBM System Storage SAN Volume Controller: Command-Line Interface User's Guide* that was supplied with your SAN Volume Controller.

Summary of Changes

This document contains terminology, maintenance, and editorial changes.

Technical changes or additions to the text and illustrations are indicated by a vertical line to the left of the change. This summary of changes describes new functions that have been added to this release.

Summary of changes for SC26-7903-01 SAN Volume Controller Command-Line Interface Guide

The Summary of changes provides a list of new, modified, and changed information since the last version of this guide.

New information

This topic describes the changes to this guide since the previous edition, SC26-7903-00. The following sections summarize the changes that have since been implemented from the previous version.

This version includes the following new information:

- Adding the following new SAN Volume Controller topics:
 - Role-based security commands
 - mkauth
 - rmath
 - lsauth
 - E-mail and inventory notification commands
 - chemail
 - chemailuser
 - lsemailuser

- mkemailuser
- sendinventoryemail
- rmailtouser
- setemail
- startemail
- stopemail
- testemail
- lsfcmapdependentmaps

Changed information

This section lists the updates that were made in this document.

The following topics have been updated:

- lsfcmap
- lsfcmapcandidate
- lsfcmapprogress
- lshost
- lsiogrp
- lsmdisk
- lsmdiskgrp
- lsnode
- lsrrconsistgrp
- lsvdisk
- mkhost
- chhost
- mkvdisk
- mkrcrelationship
- addsshkey
- rmsshkey
- rmallsshkeys
- lshbaportcandidate
- cleardumps
- cpdumps
- lscluster
- lscontroller
- lsconsistgrp
- rmmdiskgrpapplysoftware
- lsauditlogdumps
- chcluster

In addition, 140 plus commands were updated for the addition of 2 new messages associated with the role-based security commands.

The *IBM System Storage Master Console for SAN Volume Controller: Installation and User's Guide* and the *IBM System Storage Master Console for SAN Volume Controller*

Information Center are no longer updated and distributed. Instead, all pertinent information from those information units has been incorporated into other SAN Volume Controller publications.

The *IBM System Storage SAN Volume Controller Configuration Guide* is now titled *IBM System Storage SAN Volume Controller: Software Installation and Configuration Guide*.

The *IBM System Storage SAN Volume Controller Installation Guide* is now titled *IBM System Storage SAN Volume Controller: Hardware Installation Guide*.

Summary of Changes for SC26-7903-00 SAN Volume Controller Command-Line Interface Guide

The Summary of Changes provides a list of new, modified, and changed information since the last version of the guide.

New information

This topic describes the changes to this guide since the previous edition, SC26-7544-05. The following sections summarize the changes that have since been implemented from the previous version.

This version includes the following new information:

- Adding the following new SAN Volume Controller topics:
 - enablecli
 - lscopystatus
 - lsdiscoverystatus
 - Audit log commands
 - dumpauditlog
 - lsauditlogdumps
 - catauditlog

Changed information

This section lists the updates that were made in this document.

Note: In this edition, the brand "IBM TotalStorage" has been replaced with "IBM System Storage".

The following topics have been updated:

- chhost (added new parameter)
- mkhost added new parameter)
- lshost (added new parameter)
- startstats (updated description to include new statistics)
- addhostiogr (corrected syntax diagram)
- chfcmap (corrected syntax diagram)
- chrrelationship (corrected syntax diagram)
- chvdisk (corrected syntax diagram)
- lsfabric (corrected syntax diagram)
- rmhostiogr (corrected syntax diagram)

- Configuring the PuTTY session for the CLI
- chcluster (updated descriptions to include new feature)
- stopcluster (updated descriptions to include new statistics)
- applysoftware (added new parameter and messages)
- mkvdisk (corrected syntax diagram)
- mkrcrelationship (added new parameter)
- migratetoimage (updated descriptions)

Emphasis

Different typefaces are used in this guide to show emphasis.

The following typefaces are used to show emphasis:

Boldface	Text in boldface represents menu items and command names.
<i>Italics</i>	Text in <i>italics</i> is used to emphasize a word. In command syntax, it is used for variables for which you supply actual values, such as a default directory or the name of a cluster.
Monospace	Text in monospace identifies the data or commands that you type, samples of command output, examples of program code or messages from the system, or names of command flags, parameters, arguments, and name-value pairs.

SAN Volume Controller library and related publications

A list of other publications that are related to this product are provided to you for your reference.

The tables in this section list and describe the following publications:

- The publications that make up the library for the IBM System Storage SAN Volume Controller
- Other IBM publications that relate to the SAN Volume Controller

SAN Volume Controller library

The following table lists and describes the publications that make up the SAN Volume Controller library. Unless otherwise noted, these publications are available in Adobe portable document format (PDF) from the following Web site:

<http://www.ibm.com/storage/support/2145>

Title	Description	Order number
<i>IBM System Storage SAN Volume Controller: CIM Agent Developer's Reference</i>	This reference guide describes the objects and classes in a Common Information Model (CIM) environment.	SC26-7904

Title	Description	Order number
<i>IBM System Storage SAN Volume Controller: Command-Line Interface User's Guide</i>	This guide describes the commands that you can use from the SAN Volume Controller command-line interface (CLI).	SC26-7903
<i>IBM System Storage SAN Volume Controller: Software Installation and Configuration Guide</i>	This guide provides guidelines for configuring your SAN Volume Controller.	SC23-6628
<i>IBM System Storage SAN Volume Controller: Host Attachment Guide</i>	This guide provides guidelines for attaching the SAN Volume Controller to your host system.	SC26-7905
<i>IBM System Storage SAN Volume Controller: Hardware Installation Guide</i>	This guide includes the instructions that the IBM service representative uses to install the SAN Volume Controller.	GC27-2132
<i>IBM System Storage SAN Volume Controller: Planning Guide</i>	This guide introduces the SAN Volume Controller and lists the features you can order. It also provides guidelines for planning the installation and configuration of the SAN Volume Controller.	GA32-0551
<i>IBM System Storage SAN Volume Controller: Service Guide</i>	This guide includes the instructions that the IBM service representative uses to service the SAN Volume Controller.	GC26-7901
<i>IBM Safety Information</i>	This guide contains translated caution and danger statements. Each caution and danger statement in the SAN Volume Controller documentation has a number that you can use to locate the corresponding statement in your language in the <i>IBM Safety Information</i> document.	N/A

Other IBM publications

The following table lists and describes other IBM publications that contain additional information related to the SAN Volume Controller.

Title	Description	Order number
<i>IBM System Storage Multipath Subsystem Device Driver: User's Guide</i>	This guide describes the IBM System Storage Multipath Subsystem Device Driver Version 1.6 for TotalStorage Products and how to use it with the SAN Volume Controller. This publication is referred to as the <i>IBM System Storage Multipath Subsystem Device Driver: User's Guide</i> .	GC27-2122
<i>IBM TotalStorage DS4300 Fibre Channel Storage Subsystem Installation, User's, and Maintenance Guide</i>	This guide describes how to install and configure the IBM TotalStorage DS4300 Fibre-Channel Storage Subsystem.	GC26-7722
<i>IBM eServer xSeries 306m (Types 8849 and 8491) Installation Guide</i>	This guide describes how to install the IBM eServer xSeries 306m, which is the hardware delivered for some versions of the hardware master console.	MIGR-61615
<i>IBM xSeries 306m (Types 8849 and 8491) User's Guide</i>	This guide describes how to use the IBM eServer xSeries 306m, which is the hardware delivered for some versions of the hardware master console.	MIGR-61901
<i>IBM xSeries 306m (Types 8849 and 8491) Problem Determination and Service Guide</i>	This guide can help you troubleshoot and resolve problems with the IBM eServer xSeries 306m, which is the hardware delivered for some versions of the hardware master console.	MIGR-62594
<i>IBM eServer xSeries 306 (Type 8836) Installation Guide</i>	This guide describes how to install the IBM eServer xSeries 306, which is the hardware delivered for some versions of the hardware master console.	MIGR-55080
<i>IBM eServer xSeries 306 (Type 8836) User's Guide</i>	This guide describes how to use the IBM eServer xSeries 306, which is the hardware delivered for some versions of the hardware master console.	MIGR-55079
<i>IBM eServer xSeries 306 (Types 1878, 8489 and 8836) Hardware Maintenance Manual and Troubleshooting Guide</i>	This guide can help you troubleshoot problems and maintain the IBM eServer xSeries 306, which is the hardware delivered for some versions of the hardware master console.	MIGR-54820

Title	Description	Order number
<i>IBM eServer xSeries 305 (Type 8673) Installation Guide</i>	This guide describes how to install the IBM eServer xSeries 305, which is the hardware delivered for some versions of the hardware master console.	MIGR-44200
<i>IBM eServer xSeries 305 (Type 8673) User's Guide</i>	This guide describes how to use the IBM eServer xSeries 305, which is the hardware delivered for some versions of the hardware master console.	MIGR-44199
<i>IBM eServer xSeries 305 (Type 8673) Hardware Maintenance Manual and Troubleshooting Guide</i>	This guide can help you troubleshoot problems and maintain the IBM eServer xSeries 305, which is the hardware delivered for some versions of the hardware master console.	MIGR-44094
<i>IBM TotalStorage 3534 Model F08 SAN Fibre Channel Switch User's Guide</i>	This guide introduces the IBM TotalStorage SAN Switch 3534 Model F08.	GC26-7454
<i>IBM TotalStorage SAN Switch 2109 Model F16 User's Guide</i>	This guide introduces the IBM TotalStorage SAN Switch 2109 Model F16.	GC26-7439
<i>IBM TotalStorage SAN Switch 2109 Model F32 User's Guide</i>	This guide introduces the IBM TotalStorage SAN Switch 2109 Model F32. It also describes the features of the switch and tells you where to find more information about those features.	GC26-7517

Some related publications are available from the following SAN Volume Controller support Web site:

<http://www.ibm.com/storage/support/2145>

Related Web sites

The following Web sites provide information about the SAN Volume Controller or related products or technologies.

Type of information	Web site
SAN Volume Controller support	http://www.ibm.com/storage/support/2145
Technical support for IBM storage products	http://www.ibm.com/storage/support/

How to order IBM publications

The publications center is a worldwide central repository for IBM product publications and marketing material.

The IBM publications center

The IBM publications center offers customized search functions to help you find the publications that you need. Some publications are available for you to view or download free of charge. You can also order publications. The publications center displays prices in your local currency. You can access the IBM publications center through the following Web site:

<http://www.ibm.com/shop/publications/order/>

How to send your comments

Your feedback is important to help us provide the highest quality information. If you have any comments about this book or any other documentation, you can submit them in one of the following ways:

- e-mail

Submit your comments electronically to the following e-mail address:

starpubs@us.ibm.com

Be sure to include the name and order number of the book and, if applicable, the specific location of the text you are commenting on, such as a page number or table number.

- Mail





Fill out the Readers' Comments form (RCF) at the back of this book. If the RCF has been removed, you can address your comments to:

International Business Machines Corporation
RCF Processing Department
Department 61C
9032 South Rita Road
Tucson, Arizona 85775-4401
U.S.A.

Syntax diagrams

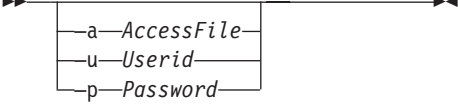
A syntax diagram uses symbols to represent the elements of a command and to specify the rules for using these elements.

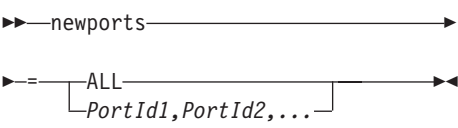
This explains how to read the syntax diagrams that represent the command-line interface (CLI) commands. In doing so, it defines the symbols that represent the CLI command elements.

Element	Syntax	Description
Main path line	>>><>() () ()	>>Begins on the left with double arrowheads (>>) and ends on the right with two arrowheads facing each other (<>). If a diagram is longer than one line, each line to be continued ends with a single> arrowhead (>) and the next line begins with a single arrowhead. Read the diagrams from left-to-right, top-to-bottom, following the main path line.
Keyword		Represents the name of a command, flag, parameter, or argument. A keyword is not in italics. Spell a keyword exactly as it is shown in the syntax diagram.
Required keywords		Indicate the parameters or arguments you must specify for the command. Required keywords appear on the main path line. Mutually exclusive required keywords are stacked vertically.
Optional keywords		Indicate the parameters or arguments you can choose to specify for the command. Optional keywords appear below the main path line. Mutually exclusive optional keywords are stacked vertically.
Default value		Appears above the main path line.
Repeatable keyword or value		Represents a parameter or argument that you can specify more than once. A repeatable keyword or value is represented by an arrow returning to the left above the keyword or value.
Variable		Represents the value you need to supply for a parameter or argument, such as a file name, user name, or password. Variables are in italics.

Element	Syntax	Description
Space separator	▶—u— — <i>Userid</i> — —p— — <i>Password</i> —▶	Adds a blank space on the main path line to separate keywords, parameters, arguments, or variables from each other.
Quotation mark delimiters	▶—d— —"— <i>ess</i> —="— <i>EssId</i> —▶ ▶—host—="—' <i>Host Name</i> ' —▶ ▶—profile—="— <i>ProfileName</i> —"—▶	Indicates the start and end of a parameter or argument that contains multiple values. Enclose one or more name–value pairs in a set of double quotation marks for a particular parameter or argument. If the value of a parameter or name–value pair contains a blank or white space, enclose the entire value in a set of single quotation marks.
Equal-sign operator	▶—"— <i>ess</i> —"= <i>EssId</i> — —profile—▶ ▶="= <i>ProfileName</i> —"—▶	Separates a name from its value in a name–value pair.
Syntax fragment	▶—Fragment Name—▶ Fragment name: —(<i>—fragment details—</i>)—	Breaks up syntax diagrams that are too long, too complex, or repetitious. The fragment name is inserted in the main diagram, and the actual fragment is shown below the main diagram.

Terminology

These are abbreviations that are most commonly used for the command-line interface operations.

The table below shows the abbreviations that are most commonly used for the command-line interface operations.

Name	Object type
Host	host
Virtual disk	vdisk
Managed disk	mdisk
Managed disk group	mdiskgrp
I/O group	iogrp
Node	node
Cluster	cluster
Controller	controller
FlashCopy [®] mapping	fcmap
FlashCopy consistency group	fcconsistgrp
Metro Mirror or Global Mirror relationship	rrelationship

Name	Object type
Metro Mirror or Global Mirror consistency group	rcconsistgrp
Unsupported/unknown object	unknown

CLI special characters

The following special characters are used in the command-line interface (CLI) command examples.

- - (minus) sign. Flags are prefixed with a - (minus) sign. Flags define the action of a command or modify the operation of a command. You can use multiple flags, followed by parameters, when you issue a command. The - character cannot be used as the first character of an object name.
- | vertical bar. A vertical bar signifies that you choose only one value. For example, [a | b] indicates that you can choose a, b, or nothing. Similarly, { a | b } indicates that you must choose either a or b.

Using wildcards in the SAN Volume Controller CLI

You can use wildcards in the SAN Volume Controller Command-Line Interface.

The SAN Volume Controller allows the use of the '*' as a wildcard within the arguments of certain parameters. There are some behavioral issues that must be considered when using wildcards in order to prevent unexpected results. These behavioral issues, and the ways to avoid them, are described below.

1. Running the command while logged onto the node.

The shell will attempt to interpret any of the special characters if they are not escaped. Wildcards will be expanded into a list of files if any files exist that match the wildcards. If no matching files exist, the wildcard is passed to the SAN Volume Controller command untouched.

To prevent expansion, issue the following command in one of its formats:

```
svctask cleardumps -prefix '/dumps/*.txt' in single quotes, or
```

```
svctask cleardumps -prefix /dumps/\*.txt using a backslash, or
```

```
svctask cleardumps -prefix "/dumps/*.txt" in double quotes.
```

2. Running the command through SSH, for example from a host.

This is slightly more complicated since the host shell will process the command line before it is passed through SSH to the shell on the cluster. This means an extra layer of protection is required around the wildcard as the host shell will strip off any protecting quotes and if the wildcard is exposed to the cluster shell, then this will result in the wildcard being expanded in the cluster shell.

To prevent expansion, issue the following command in one of its formats:

```
svctask cleardumps "'/dumps/*.txt'" with single quotes inside double quotes, or
```

```
svctask cleardumps '/dumps/\*.txt' using a backslash inside single quotes, or
```

```
svctask cleardumps "'/dumps/*.txt'"
```

with double quotes inside single quotes.

Data types and value ranges

The maximum length of any single parameter entered into the command line is 2176 bytes.

Note: If you do not specify a name when creating a new object, the cluster will assign a default name. This name is made from the object type as a prefix and the object ID as the suffix. For example, a new virtual disk (VDisk) is created with ID 5. This object will be given the default name of vdisk5. Because the system assigns these names, it will not allow you to create an object and call it vdiskx where *x* is the integer. This is because the cluster reserves these names (for example, object_type_prefix integer) for default.

Data types	Value ranges
filename_arg	<p>This is a (optionally fully qualified) file name. Maximum length is 169 characters. Valid characters consist of the following:</p> <ul style="list-style-type: none">• .• /• -• _• a - z• A - Z• 0 - 9 <p>The field may not contain two consecutive '.', or start with a '.', or end with a '.'.</p>

Data types	Value ranges
directory_or_file_filter	<p>Specifies a directory and or filename filter within the specified directory. Valid directory values consist of the following:</p> <ul style="list-style-type: none"> • /dumps • /dumps/audit • /dumps/configs • /dumps/elogs • /dumps/feature • /dumps/iostats • /dumps/iotrace • /dumps/software <p>The filename filter can be any valid filename with or without the wildcard '*'. The filename filter can be appended to the end of one of the above directory values. Maximum length is 128 characters. Valid characters consist of the following:</p> <ul style="list-style-type: none"> • * • . • / • - • _ • a - z • A - Z • 0 - 9 <p>The field may not contain two consecutive '.', or start with a '.', or end with a '.'.</p>
filename_prefix	<p>This is a prefix to be used when naming a file. Maximum length is 128 characters. Valid characters consist of the following:</p> <ul style="list-style-type: none"> • a - z • A - Z • 0 - 9 • - • _

Data types	Value ranges
name_arg	<p>Names can be specified or changed using the create and modify functions. The view commands allow you to see both the name and ID of an object.</p> <p>A string of 1-15 characters is allowed, composed of characters A-Z, a-z, 0-9, - and -.</p> <p>The first character of a name_arg must not be numeric. The first character of an object name can not be a - as the CLI will interpret it as being the next parameter.</p> <p>When creating a name for an object, the name may not consist of the object type followed only by an integer. The exception is Metro or Global Mirror relationships, which can be named anything as long as the names are unique across the two clusters. This naming convention is used by the system to generate default names. You can not use one of the following reserved words followed by an integer:</p> <ul style="list-style-type: none"> • cluster • controller • fccstgrp • fcmmap • host • io_grp • mdisk • mdiskgrp • node • rccstgrp • rcmap <p>The cluster name is set when the cluster is created.</p>
password	<p>This is a user defined password. A password must meet the following requirements:</p> <ul style="list-style-type: none"> • may use a - z, A - Z, 0 - 9 in any sequence • may use - (dash) but not as the first character • may use _ (underscore) • may contain a maximum of 15 characters
serial_number	<p>The format of this number conforms to IBM® standard C-S 1-1121-018 1999-06 Serial Numbering for IBM products. The serial number is 7 digits, the first two of which define the manufacturing location, leaving 5 digits for the product. The standard defines a way to extend the serial number using letters in the place of numbers in the 5 digit field.</p>

Data types	Value ranges
ip_address_arg	The decimal, dotted quad notation, standard rules.
dns_name	Dotted domain name for the subnet that the cluster is in. For example, <code>ibm.com[®]</code> .
hostname	<p>The hostname assigned to the cluster. This can be different from the cluster name and you can change the hostname at any time.</p> <p>A combination of the hostname and the <code>dns_name</code> that is used to access the cluster, for example:</p> <p><code>https://hostname.ibm.com/</code></p>
capacity_value	<p>A value with a range of 512 bytes up to 2 PetaBytes. The value can be expressed in multiples of 1 MB, ranging from 16 MB to 2 PetaBytes (PB).</p> <p>Note: The capacity can be specified as MB, KB, GB, or PB. When MB is used, the value is specified in multiples of 512 bytes. A capacity of 0 is valid for a striped/sequential vdisk. The smallest number of supported bytes is 512.</p>
delay_arg	Unassigned integer ranging from 1 to 65535 (minutes for battery test).
node_id	<p>Node IDs differ from other IDs as they are a unique node ID that is assigned when the node is initialized. Node IDs are expressed as 64-bit hexadecimal numbers. For example:</p> <p><code>1A2B30C67AFFE47B</code></p> <p>Node IDs, like other IDs, cannot be modified by user commands.</p>

Data types	Value ranges
xxx_id	<p>All objects are referred to by unique integer IDs that are assigned by the system when the objects are created. All IDs are represented internally as 32-bit integers. Node IDs are an exception.</p> <p>IDs in the following ranges are used to identify the various types of objects:</p> <ul style="list-style-type: none"> • node_id: 1 - 32 • mdisk_grp_id: 0 - 127 • io_grp_id: 0 - 3 (See Note.) • mdisk_id: 0 - 4095 • vdisk_id: 0 - 8191 • host_id: 0 - 127 • flash_const_grp_id: 0 - 255 • remote_const_grp_id: 0 - 255 • fcmapi_id: 0 - 4095 • rcrel_id: 0 - 8191 • controller_id: 0-63 <p>Note: io_group 4 exists but is only used in certain error recovery procedures.</p> <p>These IDs, like node IDs, cannot be modified by user commands.</p> <p>Note: IDs are assigned at run-time by the system and cannot be relied upon to be the same after, for example, the configuration restoration. Therefore, wherever possible, object names should be used in preference to IDs when working with objects.</p>
xxx_list	A colon-delimited list of values of type <i>xxx</i> .
wwpn_arg	<p>The Fibre Channel World Wide Port Name (wwpn). This is expressed as a 64-bit hexadecimal number, for example:</p> <p>1A2B30C67AFFE47B</p> <p>These numbers must be composed of the characters 0 - 9, a - f, and A - F. A command will fail if you enter WWPN 0 in the command string.</p>
panel_name	A string of up to 6 characters that correspond to the number on the printed label below the APA display on the front panel of a node in the cluster.
sequence_number	32-bit unsigned integer, expressed in decimal.
csi_num_arg	32-bit unsigned integer, expressed in decimal.
percentage_arg	8-bit unsigned integer, expressed in decimal 0 to 100.

Data types	Value ranges
extent_arg	32-bit unsigned integer, expressed in decimal.
num_extents_arg	32-bit unsigned integer, expressed in decimal.
threads_arg	8-bit unsigned integer, expressed in decimal, valid values, 1, 2, 3, or 4.
velocity_arg	The fabric speed in Giga-bits per second. Valid values are 1 or 2.
timezone_arg	The ID as detailed in the output of the svcinfolstimezones command.
timeout_arg	The command timeout period. An integer from 0 to 600 (seconds).
stats_time_arg	The frequency at which statistics are gathered. 15 up to a max of 60 (minutes) in increments of 1 minute.
directory_arg	<p>Specifies a directory and or filename filter within the specified directory. Valid directory values are:</p> <ul style="list-style-type: none"> • /dumps • /dumps/audit • /dumps/configs • /dumps/elogs • /dumps/feature • /dumps/iostats • /dumps/iotrace • /home/admin/upgrade <p>The filename filter can be any valid filename with or without the wildcard '*'. The filename filter can be appended to the end of one of the above directory values.</p>
locale_arg	<p>The cluster locale setting. Valid values are 0 to 9.</p> <ul style="list-style-type: none"> • 0 US English (default) • 1 Chinese (simplified) • 2 Chinese (traditional) • 3 Japanese • 4 Korean • 5 French • 6 German • 7 Italian • 8 Spanish • 9 Portuguese (Brazilian)
key_arg	A user definable identifier for an SSH key. A string of up to 30 characters.
user_arg	Specifies the user, either admin or service.
copy_rate	A numeric value from 0 to 100.

Data types	Value ranges
copy_type	Specifies the mirror copy type, either metro or global.

The maximum number of values that can be entered into a colon separated list is 128. If more than 128 items are entered into a list an error is returned.

CLI parameters

CLI parameters are found within the syntax diagram.

CLI parameters can be entered in any order except:

1. The first argument following the command name must be the action that is to be performed.
2. Where you are performing an action against a specific object, the object ID or name must be the last argument in the line.

A valid parameter meets the following requirements:

- Parameters can be entered in any order.
- If a parameter has an associated argument, the argument must *always* follow the parameter.
- A parameter *must* start with a '-'; otherwise, it is assumed to be an argument.
- The maximum length of any single parameter that can be entered into the CLI is 128 bytes.
- An argument can contain multiple data items. The maximum number of data items that you can enter into such a list is 128. For a component list, separate the individual items by a colon.

CLI flags

The flags that are listed below are common to all command-line interface (CLI) commands.

- **-?** or **-h**. Print help text. For example, issuing **svcinfo lscluster -h** will provide a list of the actions available with the **svcinfo lscluster** command.
- **-nomsg**. When used, this flag will prevent the display of the successfully created output. For example, if you issue the following:

```
svctask mkmdiskgrp -ext 16
```

it will display:

```
MDisk Group, id [6], successfully created
```

However, if the **-nomsg** parameter had been added, for example:

```
svctask mkmdiskgrp -ext 16 -nomsg
```

then the following would have been displayed:

```
6
```

This parameter can be entered for any command, but is only acted upon by those commands that generate the successfully created outputs. All other commands will ignore this parameter.

CLI messages

Ensure that you are familiar with the command-line interface (CLI) messages.

When some commands complete successfully, textual output is normally provided. However, some commands do not provide any output. The phrase `No feedback` is used to indicate that no output is provided. If the command does not complete successfully, an error is generated. For example, if the command has failed as a result of the cluster being unstable, the following output is provided:

- `CMMVC5786E` The action failed because the cluster is not in a stable state.

Chapter 1. Preparing the SSH client system

Before you can issue command-line interface (CLI) commands from the host to the cluster, you must prepare the Secure Shell (SSH) client system.

Microsoft® Windows® operating systems

The master console for the SAN Volume Controller includes PuTTY, which is a Windows SSH client program. PuTTY can be installed in the following ways on your master console system:

- If you purchased the master console hardware option from IBM, PuTTY has been preinstalled on the hardware.
- You can use the master console software installation CD to install PuTTY. This CD is provided with both the master console hardware option and the software-only master console.
- You can use the separate PuTTY installation wizard, **putty-<version>-installer.exe**, which is included as part of the SAN Volume Controller Console zip file. You can download the SAN Volume Controller Console zip file from the following Web site:

<http://www.ibm.com/storage/support/2145>

Note: Before you install PuTTY, ensure that your Windows system meets the requirements. See the *IBM System Storage SAN Volume Controller: Planning Guide* for system requirements.

If you want to use an SSH client other than PuTTY, the following Web site offers SSH client alternatives for Windows:

<http://www.openssh.org/windows.html>

AIX® operating systems

For AIX 5L™ Power 5.1 and 5.2, you can obtain the OpenSSH client from the Bonus Packs but you also need its prerequisite, OpenSSL, from the AIX toolbox for Linux® applications for Power Systems. For AIX 4.3.3, you can get the software from the AIX toolbox for Linux applications.

You can also get the AIX installation images from IBM DeveloperWorks at the following Web site:

<http://oss.software.ibm.com/developerworks/projects/openssh>

Linux operating systems

The OpenSSH client is installed by default on most Linux distributions. If it is not installed on your system, consult your Linux installation documentation or visit the following Web site:

<http://www.openssh.org/portable.html>

The OpenSSH client is able to run on a wide variety of additional operating systems. For more information, visit the following Web site:

Preparing the SSH client system to issue CLI commands

In order to issue command-line interface (CLI) commands to the cluster from a host, you must prepare the Secure Shell (SSH) client on the host so that the host is accepted by the SSH server on the cluster.

If you want to use a host that requires a different type of SSH client (for example, OpenSSH), follow the instructions for that software.

Perform the following steps to enable your host to issue CLI commands:

1. For the master console and Windows hosts:
 - a. Generate an SSH key pair using the PuTTY key generator.
 - b. Store the SSH clients public key on the cluster (using a browser pointing to the SAN Volume Controller Console).
 - c. Configure the PuTTY session for the CLI.
2. For other types of hosts:
 - a. Follow the instructions specific to the SSH client to generate an SSH key pair.
 - b. Store the SSH clients public key on the cluster (using a browser pointing to the SAN Volume Controller Console or the CLI from an already established host).
 - c. Follow the instructions that are specific to the SSH client to establish an SSH connection to the SAN Volume Controller cluster.

Chapter 2. Secure Shell

Secure Shell (SSH) is a client-server network application.

Overview

The SAN Volume Controller cluster acts as the SSH server in this relationship. The SSH client provides a secure environment in which to connect to a remote machine. It uses the principles of public and private keys for authentication.

SSH keys are generated by the SSH software. This includes a public key, which is uploaded and maintained by the cluster and a private key that is kept private to the host that is running the SSH client. These keys authorize specific users to access the administration and service functions on the cluster. Each key is associated with a user-defined ID string that can consist of up to 40 characters. Up to 100 keys can be stored on the cluster. You can also add new IDs and keys or delete unwanted IDs and keys.

Attention: The SAN Volume Controller does not support running multiple SSH sessions concurrently against a single cluster. This can cause the system to lose access to data and cause data to be lost. To avoid running multiple SSH sessions concurrently against a single cluster, do not run scripts that create child processes that run in the background and invoke SAN Volume Controller commands.

Secure Shell (SSH) is a communication vehicle between the host system and the following components:

- The SAN Volume Controller
- The system on which the SAN Volume Controller Console is installed

Authenticating SSH logins

When you are using AIX hosts, SSH logins are authenticated on the cluster using the RSA-based authentication that is supported in the OpenSSH client available for AIX. This scheme is based on public-key cryptography, using a scheme known commonly as RSA.

Note: The authentication process for non-AIX hosts systems is similar.

With this scheme (as in similar OpenSSH systems on other host types) the encryption and decryption is done using separate keys. This means it is not possible to derive the decryption key from the encryption key.

Because physical possession of the private key allows access to the cluster, the private key must be kept in a protected place, such as the .ssh directory on the AIX host, with restricted access permissions.

When an SSH client (A) attempts to connect to an SSH server (B), the key pair is needed to authenticate the connection. The key consists of two halves: the public and private keys. The SSH client public key is put onto the SSH Server (B) using some means outside of the SSH session. When the SSH client (A) tries to connect, the private key on the SSH client (A) is able to authenticate with its public half on the SSH server (B).

Connecting the SAN Volume Controller Console to additional clusters

The master console also has the SAN Volume Controller Console Web server and Common Information Model (CIM) Object manager software preinstalled. This software depends on the PuTTY Secure Shell (SSH) client function for the SAN Volume Controller Console to programmatically access the SAN Volume Controller cluster. The master console comes with PuTTY SSH keys preinstalled. You can generate new PuTTY SSH keys unique to your master console and copy the private SSH key to the SAN Volume Controller Console directory and store the public SSH key on all clusters to which the SAN Volume Controller Console will connect.

You can also install the SAN Volume Controller Console on a Windows 2000 server system which you provide. If you intend to install the SAN Volume Controller Console on a host which you supply, you must install PuTTY first, which is a prerequisite for the SAN Volume Controller Console.

Configuring a Secure Shell client system other than PuTTY

If you use a Secure Shell (SSH) client system, other than PuTTY, you must configure that client system before you can access the command-line interface (CLI).

Perform the tasks that are equivalent to the following steps to configure your non-PuTTY SSH client system:

1. Install the SSH client software on the computer that will host the master console. This step is not required for a master console that has PuTTY preinstalled.
2. Generate SSH keys on the SSH client system.
3. Configure the PuTTY session, if required, on the SSH client system.
4. If the client system is the master console, copy the private key into the SAN Volume Controller installation directory. If the client system is not the master console, store the private key on the SSH client system.

Attention: Do not run scripts that create child processes that run in the background and invoke SAN Volume Controller commands. This can cause the system to lose access to data and cause data to be lost.

5. Copy the SSH public key to the master console.
6. Store the SSH client public key on the SAN Volume Controller cluster.

You perform step 6 to store the SSH client public key on the SAN Volume Controller when you complete the creation of the SAN Volume Controller cluster. Once you have defined a cluster to the SAN Volume Controller Console and have therefore enabled SSH communication to the cluster, you can store additional SSH client public keys on the cluster. You can store additional keys through the SAN Volume Controller Console or the CLI.

Generating an SSH key pair using PuTTY

You must generate a Secure Shell (SSH) key pair to use the SAN Volume Controller Console and the command-line interface (CLI).

Perform the following steps to generate SSH keys on the master console using the PuTTY key generator (PuTTYgen):

1. Start PuTTYgen by clicking **Start** → **Programs** → **PuTTY** → **PuTTYgen**. The PuTTY Key Generator panel is displayed.
2. Click **SSH-2 RSA** as the type of key to generate.

Note: Leave the number of bits in a generated key value at 1024.

3. Click **Generate** and then move the cursor around the blank area of the Key section to generate the random characters that create a unique key. When the key has been completely generated, the information about the new key is displayed in the Key section.

Attention: Do not modify the Key fingerprint or the Key comment fields because your key can become invalid.

4. (Optional) If you are generating SSH keys for a computer other than the master console, enter a passphrase in the Key passphrase and Confirm passphrase fields. The passphrase encrypts the key on the disk; therefore, it is not possible to use the key without first entering the passphrase.

Attention: If you are generating the key pair for the master console, do not enter anything in the Key passphrase or the Confirm passphrase fields.

5. Save the public key by performing the following steps:
 - a. Click **Save public key**. You are prompted for the name and location of the public key.
 - b. Type `icat.pub` as the name of the public key and specify the location where you want to save the public key.

Note: For AIX, store the key in the `$HOME/.ssh` directory.

- c. Click **Save**.
6. Save the private key by performing the following steps:
 - a. Click **Save private key**. The PuTTYgen Warning panel is displayed.
 - b. Click **Yes** to save the private key without a passphrase. You are prompted for the name and location of the public key.
 - c. Type `icat` as the name of the private key and specify the location where you want to save the private key.
 - d. Click **Save**.
 - e. For AIX, store the key in the `$HOME.ssh/identity` file, which is in the `$HOME/.ssh` directory. In the simplest cases, you can replace the contents of the identity file with the contents of the key file. However, when you are using multiple keys, all of these keys must appear in the identity file.

7. Close the PuTTY Key Generator window.

After the SSH key pair is generated, you must configure the SAN Volume Controller Console to use them. For the private key, you must copy the private key to the directory that is used by the IBM CIM Object Manager. For the public key, you use the Add SSH Public Key panel in the SAN Volume Controller Console when you create the cluster.

Configuring the PuTTY session for the CLI

You must configure the PuTTY session using the Secure Shell (SSH) key pair that you have generated before you can use the command-line interface (CLI).

Attention: Do not run scripts that create child processes that run in the background and invoke SAN Volume Controller commands. This can cause the system to lose access to data and cause data to be lost.

Perform the following steps to configure a PuTTY session for the CLI:

1. Select **Start** → **Programs** → **PuTTY** → **PuTTY**. The PuTTY Configuration window opens.
2. Click **Session** in the Category navigation tree. The Basic options for your PuTTY session are displayed.
3. Click **SSH** as the Protocol option.
4. Click **Only on clean exit** as the Close window on exit option. This ensures that connection errors are displayed.
5. Click **Connection** → **SSH** in the Category navigation tree. The options controlling SSH connections are displayed.
6. Click **2** as the Preferred SSH protocol version.
7. Click **Connection** → **SSH** → **Auth** in the Category navigation tree. The Options controller SSH authentication are displayed.
8. Click **Browse** or type the fully-qualified file name and location of the SSH client and private key in the **Private key file for authentication** field. The file that you specify in this field is the one that you stored in the SAN Volume Controller software (for example, C:\Program Files\IBM\svconconsole\cimom\icat.ppk).
9. Click **Session** in the Category navigation tree. The Basic options for your PuTTY session are displayed.
10. Click **Default Settings** and then click **Save** as the Load, save or delete a stored session option.
11. Type the name or IP address of the SAN Volume Controller cluster in the **Host Name (or IP Address)** field.
12. Type the port of the SAN Volume Controller cluster in the **Port** field.
13. Type the name that you want to use to associate with this session in the **Saved Sessions** field. For example, you can name the session SAN Volume Controller Cluster 1.
14. Click **Save**.

You have now configured a PuTTY session for the CLI.

Adding subsequent SSH public keys to the SAN Volume Controller

You can add subsequent Secure Shell (SSH) public keys to the SAN Volume Controller from the SSH Public Key Maintenance panel.

This task assumes that you are at the Welcome panel for the SAN Volume Controller Console.

The SSH key allows the master console (where the SAN Volume Controller Console is running) to access the cluster.

During the cluster creation wizard, you added a SSH key to the cluster. You can add additional SSH keys to grant SSH access to other servers.

Perform the following steps to add additional SSH keys:

1. Click **Clusters** in the portfolio.
2. Click the cluster whose SSH keys you want to maintain.
3. Select **Maintain SSH Keys** from the task list and click **Go**. The SSH Public Key Maintenance panel is displayed.

4. Follow the instructions that are on the SSH Public Key Maintenance panel.
5. Click Add Key when you have completed the SSH Public Key Maintenance panel.

After the initial configuration of the cluster has been performed using the SAN Volume Controller Console and at least one SSH client key has been added, the remainder of the configuration can either be performed using the SAN Volume Controller Console or the command-line interface.

Adding SSH keys for hosts other than the master console

You can add Secure Shell (SSH) keys on other hosts.

Perform the following steps to add SSH keys on hosts other than the master console:

1. Generate the public private key pair on each host that you want to use the SAN Volume Controller command-line interface. See the information that came with your SSH client for specific details about using the key generation program that comes with your SSH client.
2. Copy the public keys from each of these hosts to the master console.
3. Secure copy these public keys from the master console to the cluster.
4. Repeat for each public key copied onto the master console in step 2.

Chapter 3. Copying the SAN Volume Controller software upgrade files using PuTTY scp

PuTTY scp (pscp) provides a file transfer application for secure shell (SSH) to copy files either between two directories on the configuration node or between the configuration node and another host.

To use pscp, you must have the appropriate permissions on the source and destination directories on your respective hosts.

The pscp application is available when you install an SSH client on your host system. You can access the pscp application through a command prompt.

Perform the following steps to use pscp:

1. Start a PuTTY session.
2. Configure your PuTTY session to access your SAN Volume Controller cluster.
3. Save your PuTTY configuration session. For example, you can name your saved session SVCPUTTY.
4. Open a command prompt.
5. Issue the following command to set the path environment variable to include the PuTTY directory:

```
set path=C:\Program Files\putty;%path%
```

Where *Program Files* is the directory where PuTTY is installed.

6. Issue the following command to copy the package onto the node where the CLI runs:

```
directory_software_upgrade_files pscp -load saved_putty_configuration  
software_upgrade_file_name admin@cluster_ip_address:home/admin/upgrade
```

Where *directory_software_upgrade_files* is the directory that contains the software upgrade files, *saved_putty_configuration* is the name of the PuTTY configuration session, *software_upgrade_file_name* is the name of the software upgrade file and *cluster_ip_address* is the IP address of your cluster.

If there is insufficient space to store the software upgrade file on the cluster, the copy process fails. Perform one of the following steps:

- Issue the **svctask cleardumps** CLI command to free space on the cluster and repeat step 6.
- Issue the following command from the cluster to transfer the error logs to the master console:

```
pscp -unsafe -load saved_putty_configuration  
admin@cluster_ip_address:/dump/elogs/* your_desired_directory
```

Where *saved_putty_configuration* is the name of the PuTTY configuration session, *cluster_ip_address* is the IP address of your cluster and *your_desired_directory* is the directory where you want to transfer to the error logs.

After you have transferred the error logs to the master console, repeat step 6.

Chapter 4. Audit log commands

An audit log keeps track of action commands that are issued through a Secure Shell (SSH) session or the SAN Volume Controller Console.

The audit log entries provide the following information:

- identity of the user who issued the action command
 - if coming from the command-line interface, the user name (administrator or service), and the label associated with the user's public SSH key in the authorized keys file
 - if coming from the native Web pages, the user's identity (admin[web] or service[web]) according to which user name the user authenticated with
 - if coming from the SAN Volume Controller Console, the user's identity (administrator), the label associated with the CIMOM's key in the authorized keys file, and the user name recorded by the CIMOM when the SAN Volume Controller Console user authenticated with the CIMOM
- the name of the actionable command
- the timestamp of when the actionable command was issued configuration node
- the parameters which were issued with the actionable command

The following commands are not documented in the audit log:

- svctask dumpconfig
- svctask cpdumps
- svctask cleardumps
- svctask finderr
- svctask dumperrlog
- svctask dumpinternallog
- svcservicetask dumperrlog
- svcservicetask finderr

The following items are also not documented in the audit log:

- Commands that fail are not logged
- A result code of 0 (success) or 1 (success in progress) is not logged
- Result object ID of node type (for the addnode command) is not logged
- Views are not logged

catauditlog

Use the **catauditlog** command to display the in-memory contents of the audit log.

Syntax

```
▶▶ svcinfo — — catauditlog —————▶  
▶ [ -first — number_of_entries_to_return ] —————▶▶
```

Parameters

-first *number_of_entries_to_return*

Optionally specifies the number of entries in the log. Specify the number of most recent entries that you want to display.

Description

This command lists a specified number of the most recently audited commands.

The in-memory portion of the audit log can hold approximately 1MB of audit information. Depending on the command text size and the number of parameters, 1MB will record approximately 6000 commands.

Once the in-memory audit log has reached its maximum capacity, the log is written to a local file on the configuration node in the /dumps/audit directory. The **svcinfa catauditlog** command only displays the in-memory part of the audit log; the on-disk part of the audit log is in readable text format and does not need any special command to decode it.

The in-memory log entries are then reset and cleared automatically, ready to start accumulating new commands. The on-disk portion of the audit log can then be analyzed at a later date.

The **lsauditlogdumps** command can be used to list the files that are on the disk.

The in-memory portion of the audit log can be transferred to an on-disk file using the **svctask dumpauditlog** command. This action clears the in-memory portion of the log.

Possible failures

- There are no error codes.

In the following example, the user has specified that they want to list the 15 most recent audit log entries.

An invocation example

```
svcinfa catauditlog -delim : -first 15
```

The resulting output

```
audit_seq_no:timestamp:cluster_user:ssh_label:icat_user:result:res_obj_id
:action_cmd
125:060311111800:admin:Joe::0::svctask rmsshkey -key label147 -user admin
126:060311111800:admin:Joe::0::svctask addsshkey -label label148 -file
/home/Joe/id_rsa.pub -user admin
127:060311111800:admin:Joe::0::svctask rmsshkey -key label148 -user admin
128:060311111800:admin:Joe::0::svctask addsshkey -label label149 -file
/home/Joe/id_rsa.pub -user admin
129:060311111800:admin:Joe::0::svctask rmsshkey -key label149 -user admin
130:060311134617:admin:Joe::0::svctask chmdisk -name ca-0 1
131:060311134617:admin:Joe::0::svctask chmdisk -name ca-1 2
132:060311134617:admin:Joe::0::svctask chmdisk -name ca-2 3
133:060311134617:admin:Joe::0::svctask chmdisk -name cb-0 4
134:060311134617:admin:Joe::0::svctask chmdisk -name cb-1 5
135:060311134617:admin:Joe::0::svctask chmdisk -name cb-2 6
136:060311134617:admin:Joe::0::svctask chmdisk -name cc-0 7
```

```
137:060311134617:admin:Joe::0::svctask chmdisk -name cc-1 8
138:060311134617:admin:Joe::0::svctask chmdisk -name cc-2 9
139:060311134632:admin:Joe::0::svctask mkmdiskgrp -name custa-mdisks -ext 512
-mdisk ca-0:ca-1:ca-2
```

dumpauditlog

Use the **dumpauditlog** command to reset or clear the contents of the in-memory audit log. The contents of the audit log are sent to a file in the `/dumps/audit` directory on the current configuration node.

Syntax

►— svctask — — dumpauditlog — —————►

Parameters

There are no parameters.

Description

This command dumps the contents of the audit log to a file on the current configuration node. It will also clear the contents of the audit log. This command is logged as the first entry in the new audit log.

Audit log dumps are automatically maintained in the `/dumps/audit` directory. The local file system space gets utilized by audit log dumps and is limited to 200MB on any node in the cluster. The space limit is maintained automatically by deleting the minimum number of old audit log dump files so that the `/dumps/audit` directory space is reduced below 200MB. This deletion occurs once per day on every node in the cluster. The oldest audit log dump files are considered to be the ones with the lowest audit log sequence number. Also, audit log dump files with a cluster ID number not matching the current one are considered to be older than any files that do match the cluster ID, regardless of sequence number.

Other than by executing dumps (or copying dump files among nodes) you cannot alter the contents of the audit directory. Each dump file name is generated automatically in the following format:

```
auditlog_<firstseq>_<lastseq>_<timestamp>_<clusterid>
```

where

- *<firstseq>* is the audit log sequence number of the first entry in the log
- *<lastseq>* is the audit sequence number of the last entry in the log
- *<timestamp>* is the timestamp of the last entry in the audit log being dumped
- *<clusterid>* is the cluster ID at the time the dump was created

The audit log dump files names cannot be changed.

The audit log entries in the dump files contain the same information as displayed by the **svcinfa catauditlog** command, however, the **svctask dumpauditlog** command displays the information with one field per line. The **svcinfa lsauditlogdumps** command displays a list of the audit log dumps that are available on the nodes in the cluster.

Possible failures

- CMMVC5786E The action failed because the cluster is not in a stable state.
- CMMVC5983E The dump file was not created. The file system might be full.

An invocation example

```
svctask dumpauditlog
```

The resulting output

No feedback

lsauditlogdumps

The **lsauditlogdumps** command generates a list of the audit log dumps that are available on the nodes in the cluster.

Syntax

```
svcinfolsauditlogdumps [-nohdr] [-delim delimiter] [node_id node_name]
```

Parameters

-nohdr

(Optional) By default, headings are displayed for each column of data (in a concise style view) and each item of data (in a detailed style view). The **-nohdr** parameter suppresses the display of these headings.

Note: If there is no data to be displayed (for example, in an empty view), the headings are not displayed.

-delim *delimiter*

(Optional) By default in a concise view, all columns of data are space separated. The width of each column is set to the maximum possible width of each item of data. In a detailed view, each item of data has its own row, and if the headers are displayed the data is separated from the header by a space. The **-delim** parameter overrides this behavior. Valid input for the **-delim** parameter is a one byte character. If you enter `-delim :`, on the command line, a colon separates all items of data in a concise view; the spacing of columns does not occur. In a detailed view, the data is separated from its header by a colon.

node_id | node_name

(Optional) Specifies the node ID or name to list the available dumps of the given type. If you do not specify a node, the files on the current configuration node are displayed.

Description

This command lists the dumps that are in the `/dumps/audit` directory on the specified node, or the configuration node if a node is not specified.

The cluster automatically creates the audit log. The audit log can also be created manually by issuing the **svctask dumpauditlog** command. The audit log comprises the files that are listed by the **svcinfolsauditlogdumps** command. These files are limited to approximately 200 MB on each node in the cluster.

Possible failures

- There are no error messages.

An invocation example

```
svcinfolsauditlogdumps
```

The resulting output

```
id auditlog_filename
0 auditlog_0_229_060311234532_0000020060013d8a
1 auditlog_230_475_060312234529_0000020060013d8a
2 auditlog_476_491_060313234527_0000020060013d8a
```

Audit log dump file contents

```
...
Auditlog Entry:23
Audit Sequence Number :138
Timestamp :Sat Mar 11 13:46:17 2006
:Epoch + 1142084777
SVC User :admin
SSH Label :Joe
ICAT User :
Result Object ID :
Result Code :0
Action Command :svctask chmdisk -name cc-2 9
Auditlog Entry:24
Audit Sequence Number :139
Timestamp :Sat Mar 11 13:46:32 2006
:Epoch + 1142084792
SVC User :admin
SSH Label :Joe
ICAT User :
Result Object ID :
Result Code :0
Action Command :svctask mkmdiskgrp -name custa-mdisks -ext
512 -mdisk ca-0:ca-1:ca-2
...
```

Chapter 5. Role-based security commands

Role-based security commands are used to restrict the administrative abilities of a user. These commands consist of the **mkauth** command (to assign a specific role of CopyOperator or Administrator), the **rmauth** command (to revert the assigned role to the default Monitor role), and the **lsauth** command (to view entries in the Role-based Security authorization table).

The roles that are assigned by the **mkauth** command relate only to SSH sessions established with the SAN Volume Controller cluster using the admin user. The commands that you can initiate in an assigned role are determined by the role that is associated with the SSH key that established the session.

Every user that is designated as an admin user also has a default role of Monitor. As a Monitor, you can initiate the following SAN Volume Controller CLI commands and functions:

svcinfo commands

All **svcinfo** commands can be initiated.

svctask commands

Only the following **svctask** commands can be initiated: **finderr**, **dumperrlog**, and **dumpinternallog**

svcservicetask commands

Only the following **svcservicetask** commands can be initiated: **finderr** and **dumperrlog**,

svcconfig backup and restore tool

A configuration backup can be performed but, a restore function can be performed by only a user that is assigned the Administrator role.

A user who is given the role of Administrator can also have the CopyOperator role assigned to them. If this role is assigned, you can initiate the following SAN Volume Controller CLI commands and functions:

svcinfo commands

All **svcinfo** commands can be initiated.

svctask commands

Only the following **svctask** commands can be initiated: **finderr**, **dumperrlog**, **dumpinternallog**, **prestartfcconsistgrp**, **startfcconsistgrp**, **stopfcconsistgrp**, **chfcconsistgrp**, **prestartfcmap**, **startfcmap**, **stopfcmap**, **chfcmap**, **starttrconsistgrp**, **stoptrconsistgrp**, **switchtrconsistgrp**, **chrconsistgrp**, **starttrrelationship**, **stoptrrelationship**, **switchtrrelationship**, **chrrelationship**, **chpartnership**

svcservicetask commands

Only the following **svcservicetask** commands can be initiated: **finderr** and **dumperrlog**,

svcconfig backup and restore tool

A configuration backup can be performed but, a restore function can be performed only by a user that is assigned the Administrator role.

A user can have the Administrator role assigned to them. If this role is assigned, you can initiate all commands and perform not only the backup function of the `svconfig` backup and restore tool but also the restore function of this tool.

mkauth

The `mkauth` command changes a user's default authorization role from that of Monitor to either CopyOperator or Administrator.

Syntax

```
svctask -- mkauth -- -label ssh_key_label --  
-role role_name
```

Parameters

-label *ssh_key_label*

(Required) Specifies the identifier associated with the secure shell (SSH) key of the user whose role authorization is being created. The SSH key label is the same identifier that you supplied with the `-label` parameter in the `svctask addsshkey` command.

-role *role_name*

(Required) Specifies the name of the role assigned to the user, either CopyOperator or Administrator.

Description

The `mkauth` command allows you to change the default role of monitor to either CopyOperator or Administrator. The roles that are assigned by the `mkauth` command relate only to SSH sessions established with the SAN Volume Controller cluster using the admin user. The commands that you can initiate in an assigned role are determined by the role that is associated with the SSH key that established the session.

Note: Only one nondefault role is supported for each SSH key. If the specified SSH key already has a nondefault role, the `mkauth` command fails.

When you assign the CopyOperator role to a user, you provide them the ability to initiate the following SAN Volume Controller CLI commands and functions:

svcinfo commands

All `svcinfo` commands can be initiated.

svctask commands

Only the following `svctask` commands can be initiated: `finderr`, `dumpperlog`, `dumpinternallog`, `prestartfcconsistgrp`, `startfcconsistgrp`, `stopfcconsistgrp`, `chfcconsistgrp`, `prestartfcmap`, `startfcmap`, `stopfcmap`, `chfcmap`, `starttrconsistgrp`, `stoptrconsistgrp`, `switchtrconsistgrp`, `chrconsistgrp`, `startrelationship`, `stoprelationship`, `switchrelationship`, `chrrelationship`, `chpartnership`

svcservicetask commands

Only the following `svcservicetask` commands can be initiated: `finderr` and `dumpperlog`,

svconfig backup and restore tool

A configuration backup can be performed, but a restore function can be performed only by a user that is assigned the Administrator role.

When you assign the **Administrator** role to a user, you provide the ability to initiate all commands and perform the backup and restore functions of the svconfig backup and restore tool.

Possible failures

- CMMVC6238E The command failed because the authorization table is full.
- CMMVC6241E The command failed because the specified role was not found.
- CMMVC6244E The command failed because the specified SSH key was not found.

Note: This command must specify an admin key.

- CMMVC6245E The command cannot set the authorization record to the default role. Use **rmauth** to set the default role.
- CMMVC6252E The command failed authorization because the session SSH key is not valid or was deleted.
- CMMVC6253E The command failed authorization because the session SSH key does not have the requisite role.

An invocation example

In the following example, the user who uses an SSH key with the label “rob” is assigned the role of CopyOperator.

```
svctask mkauth -label rob -role CopyOperator
```

The resulting output

```
[No feedback]
```

rmauth

The **rmauth** command changes a user’s assigned authorization role from that of CopyOperator or Administrator back to the default authorization of Monitor.

Syntax

```
svctask rmauth -label ssh_key_label
```

Parameters

-label *ssh_key_label*

(Required) Specifies the identifier that is associated with the secure shell (SSH) key of the user whose role authorization is being removed. The SSH key label is the same identifier that you supplied with the **-label** parameter in the **svctask addsshkey** command.

Description

The **rmauth** command allows you to remove the explicit authorization that is associated with the SSH key when you assigned a role of CopyOperator or Administrator. The specified SSH key reverts to the default Monitor authorization.

The Monitor default role allows a user to initiate the following SAN Volume Controller CLI commands and functions:

svcinfo commands

All **svcinfo** commands can be initiated.

svctask commands

Only the following **svctask** commands can be initiated: **finderr**, **dumperrlog**, and **dumpinternallog**

svcservicetask commands

Only the following **svcservicetask** commands can be initiated: **finderr** and **dumperrlog**,

svconfig backup and restore tool

A configuration backup can be performed but, a restore function can be performed only by a user that is assigned the Administrator role.

Possible failures

- CMMVC6239E The command failed because the authorization record was not found or is already set to the default role.
- CMMVC6252E The command failed authorization because the session SSH key is not valid or was deleted.
- CMMVC6253E The command failed authorization because the session SSH key does not have the requisite role.
- CMMVC6244E The command failed because the specified SSH key was not found.

Note: This command must specify an admin key.

An invocation example

In the following example, the authorization user who uses an SSH key with the label “rob” is removed. The authorization level for this user reverts to Monitor.

```
svctask rmath -label rob
```

The resulting output

[No feedback]

lsauth

The **lsauth** command generates a report that lists the default and nondefault authorizations for the admin user SSH keys. A list of these authorizations also reside in the Role Based Security authorization table.

Syntax

```
►► svcinfo -- lsauth [-label ssh_key_label]
                    [-role Administrator CopyOperator Monitor] [-nohdr]
```

└─ `-delim` ─ *delimiter* ─┘

Parameters

-label *ssh_key_label*

(Optional) Specifies the identifier that is associated with the secure shell (SSH) key. The SSH key label is the same identifier that you supplied with the **-label** parameter in the **svctask addsshkey** command.

Note: You cannot use the **-label** and **-role** parameters together.

-role **CopyOperator** | **Administrator** | **Monitor**

(Optional) Specifies that a report be generated that displays a specific role authorization that you want to view. You can only specify one role at a time. The capitalization displayed in the syntax diagram for the designated roles must be applied when you use this parameter.

You cannot use the **-role** and **-label** parameters together.

-nohdr

(Optional) By default, headings are displayed for each column of data (in a concise style view), and for each item of data (in a detailed style view). Using the **-nohdr** parameter suppresses the display of these headings.

Note: If there is no data to be displayed (an empty view is returned), no headings are displayed even if the **-nohdr** parameter was not used.

-delim *delimiter*

(Optional) By default in a concise view, all columns of data are separated with spaces. The width of each column is set to the maximum possible width of each item of data. In a detailed view, each item of data has its own row, and if the headers are displayed, the data is separated from the header by a space. Using the **-delim** parameter overrides this behavior. Valid input for the **-delim** parameter is a one-byte character. If you entered `-delim :`, a colon will separate all items of data in a concise view (the spacing of columns does not occur). In a detailed view, the data is separated from its header by a colon.

Description

The **lsauth** command generates a report that displays the entries that are found in the Role Based Security authorization table. If either the **-label** or the **-role** parameter is specified, the output only consists of entries that match the specified criteria.

Possible failures

- CMMVC6241E The command failed because the specified role was not found.
- CMMVC6244E The command failed because the specified SSH key was not found.

Note: This command must specify an admin key.

An invocation example

```
svcinfo lsauth
```

The resulting output

```
|          id  ssh_label  Role
|          0   key0      Administrator
|          1   key1      CopyOperator
|          2   key2      Monitor
|
```

Chapter 6. E-Mail and inventory event notification commands

This section contains commands that are used to set up your system to enable e-mail and inventory event notification. You can have up to twelve recipients of the notifications. You must supply the IP address of the server that receives the notifications, and you must ensure that the server is up and running (SAN Volume Controller does perform this type of a check).

The following commands are a part of the e-mail and inventory function:

setemail

Enables you to configure your system so that you can use the e-mail notification function.

chemail

Modifies settings that are used by the e-mail notification function.

mkemailuser

Allows you to specify the user, receiving server address, type of e-mail notification, and enable inventory notification in the e-mail notification function.

rmemailuser

Removes an existing e-mail recipient from the e-mail notification function.

chemailuser

Allows you to modify the e-mail recipient's information.

startemail

Starts the e-mail notification function.

stopemail

Disables the e-mail notification function.

testemail

Sends a test e-mail to a specified user or it sends a test e-mail to all users using the e-mail notification function.

lsemailuser

Generates a report that lists the users (by user ID or type of user [local or support]) receiving e-mail and inventory notifications.

lscluster

Provides information about the addition of e-mail notification recipients to the cluster.

chcluster

Enables the inventory notification function by specifying how often notifications are sent to recipients.

chemail

The **chemail** command allows you to modify the settings that are used by the e-mail notification function. To process this command, at least one of the optional parameters must be specified.

Syntax

```
svctask -- chemail [ -serverip server_ip_address ]
[ -port port ] [ -reply reply_email_address ]
[ -contact contact_name ]
[ -primary primary_telephone_number ]
[ -alternate alternate_telephone_number ]
[ -location location ]
```

Parameters

-serverip *server_ip_address*
(Optional) Specifies the IP address of the SMTP e-mail server that is used for the e-mail notification function.

-port *port*
(Optional) The port number that is used for the server IP address.

-reply *reply_email_address*
(Optional) Specifies the e-mail address to which a reply is sent.

-contact *contact_name*
(Optional) Specifies the name of the person to be contacted.

-primary *primary_telephone_number*
(Optional) Specifies the primary contact telephone number to be used.

-alternate *alternate_telephone_number*
(Optional) Specifies the alternate contact telephone number that is used when you cannot reach the primary contact on the primary phone.

-location *location*
(Optional) Specifies the physical location of the system that is reporting the error.

Description

This command modifies the specified settings that are used by the e-mail notification function. This command can be run only if the **setemail** command has been run previously. Issue the **lscluster** command to observe the state of the e-mail notification function. If a state of stopped or running is displayed, you can successfully process the **chemail** command. If a state of invalid is displayed, you cannot process the **chemail** command, but you can use the **setemail** command instead.

Possible failures

- CMMVC5786E The action failed because the cluster is not in a stable state.

- CMMVC6252E The command failed authorization because the session SSH key is wrong or was deleted.
- CMMVC6253E The command failed authorization because the session SSH key does not have the requisite role.

An invocation example

```
svctask chemail -serverip 9.20.153.255 -port 26 -primary 0441234567
-contact 'fred blogs' -reply fblogs@yahoo.com
-location 'room 256, floor 1, Lampoon House'
```

The resulting output

[No feedback]

chemailuser

The **chemailuser** command modifies the settings that are defined for an e-mail recipient. All the parameters are optional, but at least one of the parameters must be specified to process this command successfully.

Syntax

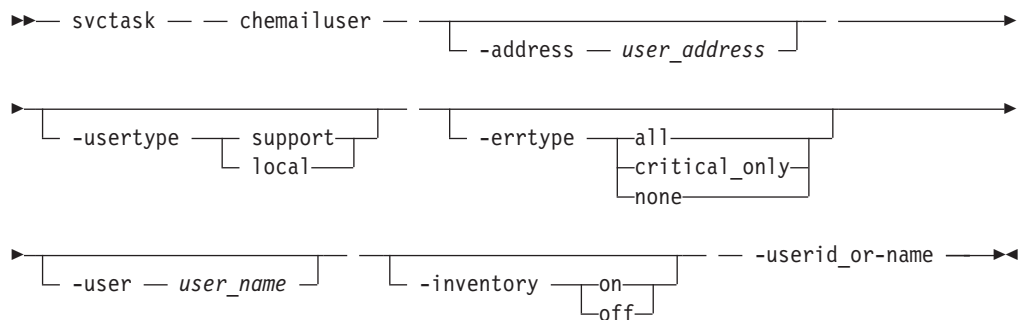

Parameters

-address *user_address*

(Optional) Specifies the e-mail address of the person receiving the e-mail and or inventory notifications.

-usertype **support** | **local**

(Optional) Specifies the type of user, either local or support, based on the following definitions:

support

Address of the support organization that provides vendor support. You cannot specify **support** if the **-errtype** parameter is specified as **all**.

local All other addresses.

-errtype **all** | **critical_only** | **none**

(Optional) Specifies the types of error for which a recipient receives e-mail notification. Recipients can receive the following types of e-mail notifications:

all The recipient receives an e-mail for all errors and events that are logged. You cannot specify this error type if you have specified that the user type is **support**.

critical_only

The recipient receives an e-mail only for critical errors. (Warning and informational errors are not included in the e-mail.)

none No e-mails are to be sent to this recipient.

-user *user_name*

(Optional) Specifies the name of the person that is the recipient of e-mail notifications. The user name must be unique. If you do not specify a user name, the system automatically assigns a user name in the format of emailuser*n* where *n* specifies a number beginning with 1 (that is, emailuser1, emailuser2, and so forth).

The name **emailuser*n*** where *n* is a number, is reserved and cannot be specified as one of your user names.

-inventory

(Optional) Specifies whether this recipient receives inventory e-mail notifications.

-userid_or_name

(Required) Specifies the e-mail recipient for whom you are modifying settings.

Description

This command modifies the settings established for an e-mail recipient. Standard rules regarding names apply; therefore, it is not possible to change a name to emailuser*n* where *n* is a number. Support users must have error type set to critical. If the wrong error type is assigned to a user type, the command fails.

Possible failures

- CMMVC5786E The action failed because the cluster is not in a stable state.
- CMMVC6252E The command failed authorization because the session SSH key is wrong or was deleted.
- CMMVC6253E The command failed authorization because the session SSH key does not have the requisite role.

An invocation example

In the following example, you are modifying e-mail recipient fblogs e-mail settings:
svctask chemailuser -usertype service fblogs

The resulting output

[no feedback]

lsemailer

The **lsemailer** command generates a report that allows you to view the e-mail notification settings for all e-mail recipients, an individual e-mail recipient, or a specified type (local or support) of e-mail recipient.

Syntax

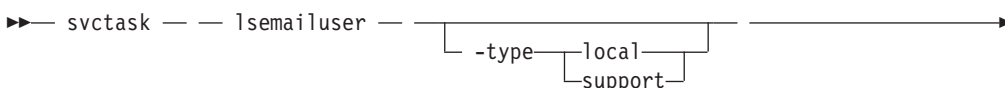

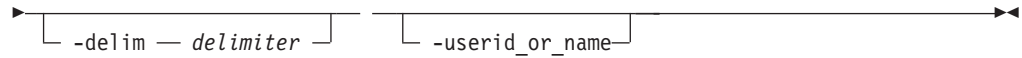

Parameters

-type support | local

(Optional) Specifies the types of e-mail recipients you want to view, either customer or support based as determined by the following definitions:

support

Address of the support organization that provides vendor support. You cannot specify **support** if the **-errtype** parameter is specified as **all**.

local All other addresses.

You cannot use this parameter with the **-userid_or_name** parameter.

-delim delimiter

(Optional) By default in a concise view, all columns of data are space separated. The width of each column is set to the maximum possible width of each item of data. In a detailed view, each item of data has its own row, and if the headers are displayed the data is separated from the header by a space. The **-delim** parameter overrides this behavior. Valid input for the **-delim** parameter is a one-byte character. If you enter `-delim :` on the command line, a colon separates all items of data in a concise view; the spacing of columns does not occur. In a detailed view, the data is separated from its header by a colon.

-userid_or_name

(Optional) Specifies the user ID or user name of the e-mail recipient for whom you want to see the e-mail notification settings. You cannot use this parameter with the **-type** parameter.

Description

When you issue this command, a report is displayed that allows you to view the e-mail notification settings for all e-mail recipients, an individual e-mail recipient, or a specified type (local or support) of e-mail recipient. The concise and detailed view report the same information.

Possible failures

- CMMVC5786E The action failed because the cluster is not in a stable state.
- CMMVC6252E The command failed authorization because the session SSH key is wrong or was deleted.
- CMMVC6253E The command failed authorization because the session SSH key does not have the requisite role.

An invocation example

In the following example, you have requested to see the information for all e-mail recipients using the e-mail notification function:

```
svcinfo lsemailuser -delim :
```

The resulting output

```

id:name:address:err_type:user_type
1:Support:callhome1@de.ibm.com:critical_only:support
2:Fred:fred_house@my_company.co.uk:critical_only:local
3:Log:our_log@my_company.co.uk:all:local
4:Anne:anne@my_company.co.uk:none:local

```

mkemailuser

The **mkemailuser** command allows you to add a recipient of e-mail and inventory notifications to the e-mail notification function. You can add up to twelve recipients, one recipient at a time.

Syntax

```

>>> svctask -- mkemailuser -- [-user user_name]
> -address user_address -- -usertype [support | local]
> -errtype [all | critical_only | none] [-enableinventoryemail]

```

Parameters

-user *user_name*

(Optional) Specifies the name of the person that is the recipient of e-mail notifications. The user name must be unique. If you do not specify a user name, the system automatically assigns a user name in the format of emailuser*n* where *n* is a number beginning with 1 (that is, emailuser1, emailuser2, and so forth).

The name, **emailuser*n*** where *n* is a number, is reserved and cannot be used as one of your user names.

-address *user_address*

(Required) Specifies the e-mail address of the person receiving the e-mail and or inventory notifications.

-usertype **support** | **local**

(Required) Specifies the type of user, either customer or support, based on the following definitions:

support

Address of the support organization that provides vendor support. You cannot specify **support** if the **-errtype** parameter is specified as **all**.

local All other addresses.

-errtype **all** | **critical_only** | **none**

(Required) Specifies the types of error for which a recipient receives e-mail notification. Recipients can receive the following types of e-mail notifications:

all The recipient receives an e-mail for all errors and events that are logged. You cannot specify this error type if you have specified that the user type is **support**.

critical_only

The recipient receives an e-mail only for critical errors. (Warning and informational errors are not included in the e-mail.)

none No e-mails are to be sent to this recipient.

-enableinventoryemail

(Optional) Specifies that this recipient is to receive inventory e-mail notifications.

Description

This command adds e-mail recipients to the e-mail and inventory notification function. You can add up to twelve recipients, one recipient at a time. When an e-mail user is added, if a user name is not specified, a default name is allocated by the system. This default name has the form of emailuser1, emailuser2, and so on. E-mail notification starts when you process the **startemail** command.

Possible failures

- CMMVC5786E The action failed because the cluster is not in a stable state.
- CMMVC6252E The command failed authorization because the session SSH key is wrong or was deleted.
- CMMVC6253E The command failed authorization because the session SSH key does not have the requisite role.

An invocation example

In the following example, you are adding e-mail recipient fblogs and designating that fblogs receive notification e-mails that contain all error types:

```
svctask mkemailuser -address fblogs@yahoo.com -errtype all -usertype local
```

The resulting output

```
email user, id [2], successfully created
```

rmemailuser

The **rmemailuser** command allows you to remove a previously defined e-mail recipient from your system.

Syntax

```
svctask -- rmemailuser -- [ -force ] -- -userid_or_name
```

Parameters

-force *server_ip_address*

(Optional) Specifies that you want to remove the designated user even though the user is the last e-mail recipient in the system. If you try to remove the last recipient using the e-mail notification function and do not use the **-force** parameter, the transaction fails.

-userid_or_name

(Required) Specifies the user ID or user name of the e-mail recipient you want to remove.

Description

This command removes an existing e-mail recipient from the system. You must use the **-force** parameter to remove the last e-mail recipient from the e-mail notification function.

Possible failures

- CMMVC5786E The action failed because the cluster is not in a stable state.
- CMMVC6252E The command failed authorization because the session SSH key is wrong or was deleted.
- CMMVC6253E The command failed authorization because the session SSH key does not have the requisite role.

An invocation example

In the following example, the you have requested the removal of e-mail recipient fblogs:

```
svctask rmemailuser fblogs
```

The resulting output

```
[No feedback]
```

sendinventoryemail

The **sendinventoryemail** command sends an inventory e-mail notification to all e-mail recipients that are enabled to receive inventory e-mail notifications. There are no parameters for this command.

Syntax

```
svctask — — sendinventoryemail
```

Parameters

There are no parameters for this command.

Description

This command sends an inventory e-mail notification to all e-mail recipients that are enabled to receive inventory e-mail notifications. This command fails if the **startemail** command has not been processed and at least one e-mail recipient using the e-mail and inventory notification function has not been set up to receive inventory e-mail notifications. This command will also fail if the email infrastructure has not been set up using the **setemail** command.

Possible failures

- CMMVC5786E The action failed because the cluster is not in a stable state.
- CMMVC6252E The command failed authorization because the session SSH key is wrong or was deleted.
- CMMVC6253E The command failed authorization because the session SSH key does not have the requisite role.

An invocation example

In the following example, you send an inventory e-mail notification to all e-mail recipients that are enabled to receive them:

```
svctask sendinventoryemail
```

The resulting output

```
[No feedback]
```

setemail

The **setemail** command allows you to configure your system to use the e-mail notification function. It also allows you to specify the data to be included in the header section of all e-mail messages, as well as the details of the server that sends the e-mail.

Syntax

```
svctask -- setemail -- -serverip -- server_ip_address --  
-port -- port -- -reply -- reply_email_address --  
-contact -- contact_name -- -primary -- primary_telephone_number --  
-alternate -- alternate_telephone_number -- -location -- location --
```

Parameters

-serverip *server_ip_address*

(Required) Specifies the IP address of the SMTP e-mail server that is used for the e-mail notification.

-port *port*

(Required) Specifies the port number that is used for the server IP address.

-reply *reply_email_address*

(Required) Specifies the e-mail address to which a reply is sent.

-contact *contact_name*

(Required) Specifies the name of the person to be contacted.

-primary *primary_telephone_number*

(Required) Specifies the primary contact telephone number.

-alternate *alternate_telephone_number*

(Optional) Specifies the alternate contact telephone number that is used when you cannot reach your primary contact on the primary phone.

-location *location*

(Required) Specifies the physical location of the system that is reporting the error.

Description

This command initializes the settings that are used by the e-mail notification function. These settings are used to define the SMTP server which is used to initiate the e-mail notification and the header information that is included in all e-mail. You must use this command to configure the system before you can start the e-mail notification function.

Possible failures

- CMMVC5786E The action failed because the cluster is not in a stable state.
- CMMVC6252E The command failed authorization because the session SSH key is wrong or was deleted.
- CMMVC6253E The command failed authorization because the session SSH key does not have the requisite role.

An invocation example

```
svctask setemail -serverip 9.20.153.255 -port 26 -primary 01234567890  
-contact 'fred blogs' -reply fblogs@yahoo.com  
-location 'room 256, floor 1, Lampoon House'
```

The resulting output

[No feedback]

startemail

The **startemail** command activates the e-mail and inventory notification function. There are no parameters for this command.

Syntax

```
▶— svctask — — startemail —————▶
```

Parameters

There are no parameters for this command.

Description

This command enables the e-mail error notification service. No e-mails are sent to users until the **startemail** command has been run and at least one user has been defined to the system.

Possible failures

- CMMVC5786E The action failed because the cluster is not in a stable state.
- CMMVC6252E The command failed authorization because the session SSH key is wrong or was deleted.
- CMMVC6253E The command failed authorization because the session SSH key does not have the requisite role.

An invocation example

In the following example, you are starting the e-mail error notification service.

```
svctask startemail
```

The resulting output

[No feedback]

stopemail

The **stopemail** command stops the e-mail and inventory notification function. There are no parameters for this command.

Syntax

```
►— svctask — — stopemail —————▶
```

Parameters

There are no parameters for this command.

Description

This command stops the e-mail error notification function. No e-mails are sent to users until the **startemail** command is reissued.

Possible failures

- CMMVC5786E The action failed because the cluster is not in a stable state.
- CMMVC6252E The command failed authorization because the session SSH key is wrong or was deleted.
- CMMVC6253E The command failed authorization because the session SSH key does not have the requisite role.

An invocation example

In the following example, you have stopped the e-mail and inventory notification function:

```
svctask stopemail
```

The resulting output

```
[No feedback]
```

testemail

The **testemail** command allows you to send an e-mail notification to one user of the e-mail notification function or to all users of the e-mail notification function to ensure that the function is operating correctly.

Syntax

```
►— svctask — — testemail —-userid_or_name————▶  
└──all──────────┘
```

Parameters

-userid_or_name

(Required if you do not specify **-all**) Specifies the user ID or user name of the e-mail recipient that you want to send a test e-mail to. You cannot use this parameter with the **-all** parameter.

all (Required if you do not specify **-userid_or_name**) Specifies that you want the system to send a test e-mail to all the e-mail recipients who are not assigned an error type of none and who are assigned the use of the e-mail notification function. You cannot use this parameter with the **-userid_or_name** parameter.

Description

This command sends test e-mails to the specified e-mail users. The e-mail recipient expects to receive the test e-mail within a specified service time. If the e-mail is not received within the expected time period, the recipient must contact the administrator to ensure that the e-mail settings for the user are correct. If there is still a problem, the IBM Support Center must be contacted

The e-mail recipient uses the test e-mail to check that the SMTP name, the IP address, the SMTP port, and the user address are valid.

Possible failures

- CMMVC5786E The action failed because the cluster is not in a stable state.
- CMMVC6252E The command failed authorization because the session SSH key is wrong or was deleted.
- CMMVC6253E The command failed authorization because the session SSH key does not have the requisite role.

An invocation example

In the following example, you have sent a test e-mail to fblogs:

```
svctask testemail fblogs
```

The resulting output

```
[No feedback]
```

Chapter 7. Cluster commands

Cluster commands are used to monitor and modify clusters.

There are a number of cluster commands used for various tasks. A cluster is a pair of nodes that provide a single configuration and service interface.

addnode

You can use the **addnode** command to add a new (candidate) node to an existing cluster. You can enter this command any time after a cluster has been created. If you are adding a new node to a cluster, you must ensure that the model type of the new node is supported by the SAN Volume Controller software version of the cluster. If the model type is not supported by the cluster software, you must upgrade the cluster to a software version that supports the new node's model type.

Syntax

```
svctask -- addnode -- [-panelname -- panel_name] -- [-wwnodename -- wwnn_arg] -- [-name -- new_name_arg] -- [-iogrp -- [iogroup_name | iogroup_id]]
```

Parameters

-panelname *panel_name*

(Required if you do not specify the **-wwnodename** parameter) Specifies the node that you want to add to a cluster by the name that is displayed on the display panel. You cannot use this parameter with the **-wwnodename** parameter.

-wwnodename *wwnn_arg*

(Required if you do not specify the **-panelname** parameter) Specifies the node that you want to add to the cluster by the worldwide node name (WWNN) of the node. You cannot use this parameter with the **-panelname** parameter.

-name *new_name_arg*

(Optional) Specifies a name for the node that you want to add to the cluster.

-iogrp *iogroup_name* | *iogroup_id*

(Required) Specifies the I/O group to which you want to add this node.

Description

This command adds a new node to the cluster. You can obtain a list of candidate nodes (those that are not already assigned to a cluster) by typing `svcinfo lsnodecandidate`.

Before you add a node to the cluster, you must check to see if any of the following conditions are true. If the following conditions exist, failure to follow the procedures documented here might result in the corruption of all data managed by the cluster.

- Does the node being added to the cluster use physical node hardware or a slot which has previously been used for a node in the cluster?
- Does the node being added to the cluster use physical node hardware that has been used as a node in another cluster and both clusters have the visibility of the same hosts?

If any of the previous conditions are true, you must take the following actions:

1. Add the node to the same I/O group that it was previously in. You can use the command-line interface (CLI) command **svcinfolnode** or the SAN Volume Controller Console to determine the WWNN of the cluster nodes.
2. Shut down all of the hosts using the cluster, before you add the node back into the cluster.
3. Add the node back to the cluster before the hosts are restarted. If the I/O group information is unavailable or it is inconvenient to shut down and restart all of the hosts using the cluster, you can do the following:
 - On all of the hosts connected to the cluster, unconfigure the fibre-channel adapter device driver, the disk device driver and multipathing driver before you add the node to the cluster.
 - Add the node to the cluster and then reconfigure the fibre-channel adapter device driver, the disk device driver, and multipathing driver.

If you are adding a new node to a cluster, take the following actions:

- Ensure that the model type of the new node is supported by the SAN Volume Controller software version of the cluster. If the model type is not supported by the cluster software, you must upgrade the cluster to a software version that supports the new node's model type.
- Record the node serial number, the WWNN, all WWPNN's, and the I/O group to which the node has been added. You might need to use this information later and having it available can prevent possible data corruption if the node must be removed from and re-added to the cluster.

Node addition completes asynchronously. This means while the node is in the adding state, the WWPNN is not known and will display as zeroes.

If the compatibility check fails, the following message displays:

```
CMMVC6201E The node could not be added, because incompatible
software: status code [%1].
```

Other considerations when adding a node to a cluster:

When a node is added to the cluster using the **svctask addnode** command or the cluster GUI, you must confirm whether the node has previously been a member of the cluster. If it has, follow one of these two procedures:

- the node must be added back to the same I/O group that it was previously in. The WWNN of the nodes in the cluster can be determined using the **svcinfolnode** command. Or,
- if this information is not available, call the support team to add the node back into the cluster without corrupting the data.

When a node is added to a cluster, it displays a state of adding. It can take as much as 30 minutes for the node to be added to the cluster, particularly if the software version of the node has changed.

| **Attention:** If the node remains in the adding state for more than 30 minutes,
| contact your support representative to assist you in resolving this issue.

| Optionally, you can assign a name to the new node. You can use this name in
| subsequent commands to refer to the node, instead of using the node ID. If you
| assign a label, this label is displayed as the node name from then on. If you do not
| assign a label, the default label is nodeX, where X is the node ID.

| Applications on a host system direct I/O operations to filesystems or logical
| volumes which are mapped by the operating system to vpaths, which are pseudo
| disk objects supported by the SDD driver. See the *Multipath Subsystem Device
| Driver: User's Guide* for more information.

| The SDD driver maintains an association between a vpath and a VDisk. This
| association uses an identifier (UID), which is unique to the VDisk and is not
| reused. This enables the SDD driver to unambiguously associate vpaths with
| VDIsks.

| The SDD device driver operates within a protocol stack, which also contains disk
| and fibre-channel device drivers that enable it to communicate with the cluster
| using the SCSI protocol over fibre-channel as defined by the ANSI FCS standard.
| The addressing scheme provided by these SCSI and fibre-channel device drivers
| uses a combination of a SCSI logical unit number (LUN) and the world wide name
| for the fibre-channel node and ports.

| In the event of errors occurring, error recovery procedures (ERPs) operate at
| various tiers in the protocol stack. Some of these ERPs cause I/O to be redriven
| using the same WWNN and LUN numbers which were previously used.

| The SDD device driver does not check the association of the VDisk with the vpath
| on every I/O operation that it performs.

Possible failures

- CMMVC5707E Required parameters are missing.
- CMMVC5786E The action failed because the cluster is not in a stable state.
- CMMVC5790E The node was not added to the cluster because the maximum number of nodes has been reached.
- CMMVC5791E The action failed because an entity that was specified in the command does not exist.
- CMMVC5792E The action failed because the I/O group is used for recovery.
- CMMVC5793E The node was not added to the cluster because the I/O group already contains a pair of nodes.
- CMMVC5777E The node was not added to the I/O group because the other node in the I/O group is in the same power domain.
- CMMVC6201E The node could not be added, because incompatible software: status code [%1].

An invocation example

```
svctask addnode -wwnodename 210000e08b053564 -iogrp io_grp0
```

The resulting output

```
Node, id [6], successfully added
```

chcluster

The **chcluster** command modifies the attributes of an existing cluster. You can enter this command any time after a cluster has been created. All the parameters that are associated with this command are optional. If you do not specify a parameter and attempt to process this command, nothing happens.

Syntax

```
svctask -- chcluster [-clusterip cluster_ip_address]
                  [-serviceip service_ip_address] [-name cluster_name]
                  [-admpwd password] [-servicepwd password]
                  [-gw default_gateway] [-mask subnet_mask]
                  [-speed fabric_speed] [-alias id_alias]
                  [-icatip icat_console_ip_address]
                  [-invemailinterval interval]
                  [-gmlinktolerance link_tolerance]
                  [-gminterdelaysimulation inter_cluster_delay_simulation]
                  [-gmintradelaysimulation intra_cluster_delay_simulation]
```

Parameters

-clusterip *cluster_ip_address*

(Optional) Specifies the new cluster IP address.

Note: After the cluster IP address is changed, you lose the open shell connection to the cluster. You must reconnect with the newly specified IP address.

-serviceip *service_ip_address*

(Optional) Specifies the new service IP address. This address is the address to use if the node must be started after it has been released from the cluster. You can specify this parameter with either a fixed IP address, or if you want to use a dynamic IP address, DHCP.

-name *cluster_name*

(Optional) Specifies a new name for the cluster.

-admpwd *password*

(Optional) Specifies a new administrator password. You can specify this parameter with or without the password. If this parameter is not followed by a password, you are prompted for the password. When you type the password in response to the prompt, the password is not displayed.

Note: Only a person with administrator authority can change the password.

-servicepwd *password*

(Optional) Specifies a new service user password. You can specify this parameter with or without the password. If the parameter is not followed by a password, you are prompted for the password. When you type the password in response to the prompt, the password is not displayed.

Note: Only a person with administrator authority can change the password.

-gw *default_gateway*

(Optional) Specifies the new default gateway IP address of the cluster.

-mask *subnet_mask*

(Optional) Specifies the new subnet mask of the cluster.

-speed *fabric_speed*

(Optional) Specifies the speed of the fabric to which this cluster is attached. Valid values are 1 or 2 (Gb).

Attention: Changing the speed on a running cluster breaks I/O service to the attached hosts. Before changing the fabric speed, stop I/O from active hosts and force these hosts to flush any cached data by demounting volumes (for UNIX host types) or removing drive letters (for Windows host types). Some hosts might need to be rebooted to detect the new fabric speed.

The fabric speed setting applies only to the 4F2 and 8F2 model nodes in a cluster. The 8F4 nodes automatically negotiate the fabric speed on a per-port basis.

-alias *id_alias*

(Optional) Does not change the basic ID for the cluster, but does influence the VDisk_UID of every **vdiskhostmap**, both existing and new. These objects appear to have been created for a cluster whose ID matches the alias.

-icatip *icat_console_ip_address*

(Optional) Specifies the new IP address used by this cluster. The format of this IP address must be a dotted decimal notation with the port (for example, 255.255.255.255:8080).

-invemailinterval *interval*

(Optional) Specifies the interval at which inventory e-mails are sent to the designated e-mail recipients. The interval range is 0 to 15. The interval is measured in days. Setting the value to 0 turns the inventory e-mail notification function off.

-gmlinktolerance *link_tolerance*

(Optional) Specifies the length of time, in seconds, for which an inadequate intercluster link is tolerated for a Global Mirror operation. The parameter accepts values from 60 to 86 400 seconds in steps of 10 seconds. The default is 300 seconds. You can disable the link tolerance by entering a value of zero (0) for this parameter.

-gminterdelaysimulation *inter_cluster_delay_simulation*

(Optional) Specifies the intercluster delay simulation, which simulates the

Global Mirror round trip delay between two clusters, in milliseconds. The default is 0; the valid range is 0 to 100 milliseconds.

-gmintradelaysimulation *intra_cluster_delay_simulation*
(Optional) Intracluster delay simulation, which simulates the Global Mirror round trip delay in milliseconds. The default is 0; the valid range is 0 to 100 milliseconds.

Description

This command modifies specific features of a cluster. Multiple features can be changed by issuing a single command.

If the cluster IP address is changed, the open command-line shell closes during the processing of the command. You must reconnect to the new IP address.

The service IP address is not used until a node is expelled from the cluster. If this node cannot rejoin the cluster, you can bring the node up in service mode. In this mode, the node can be accessed as a stand-alone node using the service IP address.

If you do not specify any of the optional parameters, the command does nothing.

Modifying a password: To change the administrator user password, issue the **svtask chcluster -admpwd *password*** command. To change the service user password, issue the **svtask chcluster -admpwd *password*** command.

Note: If you do not want the password displayed as you enter the command line, omit the new password. The command line tool then prompts you to enter and confirm the password without the password being displayed.

Modifying an IP address: List the IP address of the cluster, by issuing the **svinfo lscluster** command. Modify the IP address, by issuing the **svtask chcluster** command. You can either specify a static IP address or have a dynamic IP address assigned.

Possible failures

- CMMVC5786E The action failed because the cluster is not in a stable state.
- CMMVC5789E The cluster was not modified because the IP address, subnet mask, service address, SNMP address, or gateway address is not valid.
- CMMVC6252E The command failed authorization because the session SSH key is wrong or was deleted.
- CMMVC6253E The command failed authorization because the session SSH key does not have the requisite role.

An invocation example

```
svtask chcluster -clusterip 9.20.165.16 -servicepwd myownpassw0rd -gw 9.13.56.87
```

The resulting output

No feedback

chiogrp

The **chiogrp** command allows you to assign a name to an I/O group or to change the name that is assigned to an I/O group.

Syntax

```
svctask -- chiogrp -- -name -- new_name_arg --  
└─┬─ io_group_id ─┬─  
  │ io_group_name ─┘
```

Parameters

-name *new_name_arg*

(Required) Specifies the name to assign to the I/O group.

-io_group_id | **io_group_name**

(Required) Specifies the I/O group that you want to modify by assigning a new name.

Description

This command assigns a name to an I/O group or changes the name of a specified I/O group.

The I/O groups already exist by default when a cluster is created, but they do not contain any nodes. The first node in the cluster is always assigned to I/O group zero.

Possible failures

- CMMVC5786E The action failed because the cluster is not in a stable state.
- CMMVC5800E The action failed because an entity that was specified in the command does not exist.
- CMMVC5792E The action failed because the I/O group is used for recovery.
- CMMVC6252E The command failed authorization because the session SSH key is wrong or was deleted.
- CMMVC6253E The command failed authorization because the session SSH key does not have the requisite role.

An invocation example

```
svctask chiogrp -name testiogrpone io_grp0
```

The resulting output

No feedback

chnode

You can use the **chnode** command to change the name, or label, assigned to a node. The name can then be used from then on for subsequent command line tools.

Syntax

```
svctask -- chnode -- -name -- new_node_name -- ┌─ node_name ─┐  
└─┬─ node_name ─┬─┘ ┌─ node_id ─┐
```

Parameters

-name *new_node_name*

Specifies the name to assign to the node.

node_name | node_id

Specifies the node to be modified. The argument that follows the flag is either:

- The node name, that is, the label that you assigned when you added the node to the cluster.
- The node ID that is assigned to the node [not the worldwide node name (WWNN)].

Description

This command changes the name, or label, assigned to the node in question. The name can be used from then on in subsequent command-line tools.

Possible failures

- CMMVC5786E The action failed because the cluster is not in a stable state.
- CMMVC5798E The action failed because the node is offline.

An invocation example

```
svctask chnode -name testnodeone nodeone
```

The resulting output

No feedback

cleardumps

The **cleardumps** command cleans the various dump directories on a specified node.

Syntax

```
svctask --cleardumps -- -prefix -- directory_or_file_filter --
```

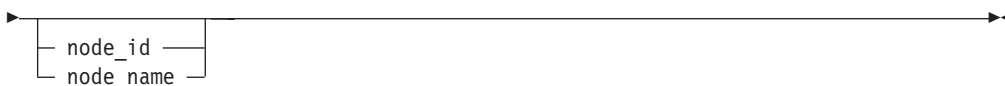

Parameters

-prefix *directory_or_file_filter*

(Required) Specifies the directory, files, or both to be cleaned. If a directory is specified, with no file filter, all relevant dump or log files in that directory are cleaned. The directory arguments include:

- /dumps (cleans all files in all subdirectories)
- /dumps/audit
- /dumps/configs
- /dumps/elogs
- /dumps/feature
- /dumps/iostats
- /dumps/iotrace

- /home/admin/upgrade

In addition to the directory, a file filter can be specified. For example, if you specified /dumps/elogs/*.txt all files in the /dumps/elogs directory that end in .txt will be cleaned.

Note: The following rules apply to the use of wildcards with the SAN Volume Controller CLI:

- The wildcard character is an asterisk (*).
- The command can contain a maximum of one wildcard.
- With a wildcard, you must use double quotation marks around the filter entry, such as in the following entry:

```
>svctask cleardumps -prefix "/dumps/elogs/*.txt"
```

node_id | node_name

(Optional) Specifies the node to be cleaned. The argument that follows the flag is either:

- The node name, that is, the label that you assigned when you added the node to the cluster
- The node ID that is assigned to the node [not the worldwide node name (WWNN)].

Description

This command deletes all the files that match the directory/file_filter argument on the specified node. If no node is specified, the configuration node is cleaned.

You can clean all the dumps directories by specifying /dumps as the directory argument.

You can clean all the files in a single directory by specifying one of the directory arguments.

You can list the contents of these directories on the given node by using the **svcinfolxxxxdumps** commands.

You can use this command to clean specific files in a given directory by specifying a directory or file name. The wildcard character can be used as part of the file name.

Note: In order to preserve the configuration and trace files, any files that match the following wildcard patterns are not cleaned:

- *svc.config*
- *.trc
- *.trc.old

Possible failures

- CMMVC5985E The action failed because the directory that was specified was not one of the following directories: /dumps, /dumps/iostats, /dumps/iotrace, /dumps/feature, /dumps/configs, /dumps/elogs, or /home/admin/upgrade.

An invocation example

```
svctask cleardumps -prefix /dumps/configs
```

The resulting output

No feedback

cpdumps

The **cpdumps** command copies dump files from a nonconfiguration node onto the configuration node.

Note: In the rare event that the /dumps directory on the configuration node is full, the copy action ends when the directory is full and provides no indicator of a failure. It is therefore advisable to clear the /dumps directory after the desired data has been migrated off the configuration node.

Syntax

```
svctask -- cpdumps -- -prefix [directory | file_filter]
node_name
node_id
```

Parameters

-prefix *directory* | *file_filter*

(Required) Specifies the directory, or files, or both to be retrieved. If a directory is specified with no file filter, all relevant dump or log files in that directory are retrieved. The directory arguments include:

- /dumps (retrieves all files in all subdirectories)
- /dumps/audit
- /dumps/configs
- /dumps/elogs
- /dumps/feature
- /dumps/iostats
- /dumps/iotrace
- /home/admin/upgrade

In addition to the directory, you can specify a file filter. For example, if you specified /dumps/elogs/*.txt all files in the /dumps/elogs directory that end in .txt will be copied.

Note: The following rules apply to the use of wildcards with the SAN Volume Controller CLI:

- The wildcard character is an asterisk (*).
- The command can contain a maximum of one wildcard.
- When using a wildcard, it is important to surround that filter entry with double quotes like the following display:

```
>svctask cleardumps -prefix "/dumps/elogs/*.txt"
```

node_id | **node_name**

(Required) Specifies the node from which to retrieve the dumps. The argument that follows the flag is either:

- The node name, that is, the label that you assigned when you added the node to the cluster

- The node ID that is assigned to the node [not the worldwide node name (WWNN)].

If the node specified is the current configuration node, no file will be copied.

Description

This command copies any dumps that match the directory or file criteria from the given node to the current configuration node.

You can retrieve dumps that were saved to an old configuration node. When the old configuration node failed over to another node, the dumps that were on the old configuration node are not automatically copied. Because access from the CLI is only provided to the configuration node, files can only be copied off the cluster from the configuration node. This command enables you to retrieve files and place them on the configuration node so that you can then copy them off of the cluster.

You can view the contents of the directories by using the `svcinfolsxdddumps` commands.

Possible failures

- CMMVC5985E The action failed because the directory that was specified was not one of the following directories: `/dumps`, `/dumps/iostats`, `/dumps/iotrace`, `/dumps/feature`, `/dumps/configs`, `/dumps/elogs`, or `/home/admin/upgrade`.

An invocation example

```
svctask cpdumps -prefix /dumps/configs nodeone
```

The resulting output

No feedback

detectmdisk

The **detectmdisk** command allows you to manually rescan the fibre-channel network for any new managed disks (MDisks) that might have been added and to rebalance MDisk access across the available controller device ports.

Syntax

```
▶— svctask — — detectmdisk —————▶
```

Description

This command causes the cluster to rescan the fibre-channel network. The rescan discovers any new MDisks that might have been added to the cluster and rebalances MDisk access across the available controller device ports. This command also detects if a controller is being decommissioned.

Note: Although it might appear that the **detectmdisk** command has completed, some extra time might be required for it to run. The **detectmdisk** is asynchronous and returns a prompt while the command continues to run in the background.

In general, the cluster automatically detects disks when they appear on the network. However, some fibre-channel controllers do not send the required SCSI primitives that are necessary to automatically discover the new disks.

If you have attached new storage and the cluster has not detected it, you might need to run this command before the cluster detects the new disks.

When back-end controllers are added to the fibre-channel SAN and are included in the same switch zone as a cluster, the cluster automatically discovers the back-end controller and integrates the controller to determine what storage is presented to it. The SCSI LUs that are presented by the back-end controller are displayed as unmanaged MDisks. However, if the configuration of the back-end controller is modified after this has occurred, the cluster might be unaware of these configuration changes. This task allows a user to request the cluster to rescan the fibre-channel SAN to update the list of unmanaged MDisks.

Note: The automatic discovery that is performed by the cluster does not write anything to an unmanaged MDisk. It is only when a user instructs the cluster to add an MDisk to an MDisk group or use an MDisk to create an image mode virtual disk that the storage is actually used.

Discovering MDisks: Check to see which MDisks are available by issuing the `svctask detectmdisk` command to manually scan the fibre-channel network for any MDisks. Issue the `svcinfolsmdiskcandidate` command to show the unmanaged MDisks. These MDisks have not been assigned to an MDisk group. Alternatively, you can issue the `svcinfolsmdisk` command to view all of the MDisks.

Possible failures

- CMMVC5786E The action failed because the cluster is not in a stable state.
- CMMVC6252E The command failed authorization because the session SSH key is wrong or was deleted.
- CMMVC6253E The command failed authorization because the session SSH key does not have the requisite role.

An invocation example

```
svctask detectmdisk
```

The resulting output

```
No feedback
```

rmnode

The `rmnode` command deletes a node from the cluster. You can enter this command any time after a cluster has been created.

Syntax

```
svctask -- rmnode -- node_name | node_id
```

Parameters

`node_name` | `node_id`

Specifies the node to be deleted. The value for this parameter is either:

- The node name, that is, the label that you assigned when you added the node to the cluster
- The node ID that is assigned to the node [not the worldwide node name (WWNN)].

Description

This command removes a node from the cluster. This makes the node a candidate to be added back into this cluster or into another cluster. After the node is deleted, the other node in the I/O group destages the contents of its cache and goes into write-through mode until another node is added back into the I/O group.

Prerequisites:

Before you issue the **rmnode** command, perform the following tasks and read the following Attention notices to avoid losing access to data:

1. Determine which virtual disks (VDisks) are still assigned to this I/O group by issuing the following command. The command requests a filtered view of the VDisks, where the filter attribute is the I/O group.

```
svcinfolsvdisk -filtervalue IO_group_name=<name>
```

where <name> is the name of the I/O group in question.

Note: Any VDisks that are assigned to the I/O group that this node belongs to, are assigned to the other node in the I/O group; that is, the preferred node is changed. You cannot change this setting back.

2. Determine the hosts that the VDisks are mapped to by issuing the **svcinfolsvdiskhostmap** command.
3. Determine if any of the VDisks assigned to this I/O group contain data that you need to maintain access to:
 - If you *do not* want to maintain access to these VDisks, go to step 5.
 - If you *do* want to maintain access to some or all of the VDisks, back up the data or migrate the data to a different (online) I/O group.
4. Determine if you need to turn the power off to the node:
 - If this is the last node in the cluster, you do not need to turn the power off to the node. Go to step 5.
 - If this is *not* the last node in the cluster, turn the power off to the node that you intend to remove. This step ensures that the Subsystem Device Driver (SDD) does not rediscover the paths that are manually removed before you issue the delete node request.
If you plan to add the node back into the cluster, see **Adding a node back into the cluster:** below.
5. Update the SDD configuration for each virtual path (vpath) that is presented by the VDisks that you intend to remove. Updating the SDD configuration removes the vpaths from the VDisks. Failure to update the configuration can result in data corruption. See the *Multipath Subsystem Device Driver: User's Guide* for details about how to dynamically reconfigure SDD for the given host operating system.
6. Quiesce all I/O operations that are destined for the node you are deleting. Failure to quiesce the operations could result in failed I/O operations being reported to your host operating systems.

Attention: Removing the last node in the cluster destroys the cluster. Before you delete the last node in the cluster, ensure that you want to destroy the cluster.

Attention: If you are deleting a single node and the other node in the I/O group is online, the cache on the partner node changes into the write-through mode, causing the data to be exposed to a single point of failure if the partner node fails.

Note:

1. If the node you are removing is the configuration node, it can take one or two minutes to complete the command.
2. If the node you are removing is the last node in the cluster, the cluster might seem to hang for up to 3 minutes because you have removed the last access point to the cluster.

Deleting a node from a cluster:

Note:

1. If this is the last node in the I/O group or the last node in the cluster, you are asked to force the deletion.
2. If this is the last node in the cluster or if it is currently assigned as the configuration node, all connections to the cluster are lost. The user interface and any open CLI sessions are lost if the last node in the cluster is deleted. Deleting the configuration node results in the CLI failing over to another node. A time-out might occur if a command cannot be completed before the node is deleted.

Issue the **svctask rmnode** command to delete a node from the cluster. You can enter this command any time after a cluster has been created.

Adding a node back into the cluster:

If you turn the power back on to the node that has been removed while it is still connected to the same fabric or zone, the following actions occur:

1. The node attempts to join the cluster again.
2. The cluster signals the node to remove itself from the cluster.
3. The node becomes a candidate for addition to this cluster or another cluster.

If you intend to add this node back into the cluster, ensure that you add it back to the same I/O group from which you are deleting it. Otherwise, data corruption might occur.

Before you add a node back into the cluster, you need to know the following information, which should have been recorded when the node was originally added to the cluster.

- Node serial number
- WWNN
- All worldwide port names (WWPNs)
- I/O group that contains the node

If you do not have access to this information, call the service team to add the node back into the cluster without corrupting the data.

Replacing a faulty node:

You can replace a failed node with a “spare” or replacement node. This would be necessary if the node fails. The cluster continues to operate with degraded performance until the failed node is repaired. To enhance availability, you might choose to replace the failed node with a “spare”, then repair the node offline. However, various procedures must be followed and precautions taken, to replace a failed node without interrupting I/O and without risk to data integrity when the repaired node is reconnected to the SAN fabric. The procedure involves changing the World Wide Node Name (WWNN) of the replacement node. This procedure must be followed with care to avoid duplicate WWNNs which are illegal and can cause data corruption.

Prerequisites:

Before replacing the failed node you must:

- Ensure that the GUI that is used to access the cluster and spare node is running at least version 1.1.1 of the software.
- Know the cluster name that contains the failing node.
- Confirm that a spare node is in the same rack as the cluster containing the failed node.
- Make a record of the last five characters of the original WWNN. This identification is needed if you decide in the future to designate the spare node as a normal node that can be assigned to any cluster. Use the `svcinfo lsnode` command to see the WWNN.

Additional Information

When you replace a node, the following process takes place:

- The node Front Panel ID changes. This is the number printed on the front of the node and it is used to select the node that is to be added to a cluster.
- The node name might change. If you permit the cluster to assign default names when adding nodes to the cluster it creates a new name each time a node is added. If you choose to assign your own names, then you must type in the node name that you want to use. If you are using scripts to perform management tasks on the cluster and those scripts use the node name, then by assigning the original name to a replacement node you avoid the need to make changes to the scripts following service activity on the cluster.
- The Node ID changes. A new Node ID is assigned each time a node is added to a cluster. The Node ID or the node name can be used when performing management tasks on the cluster but, if scripts are being used to perform those tasks, it is recommended that the node name is used in preference to the Node ID since the node name remains unchanged following service activity on the cluster.
- The World Wide Node Name (WWNN) does not change. The WWNN is used to uniquely identify the node and the fiber channel ports. The node replacement procedure changes the WWNN of the spare node to match that of the failed node. The node replacement procedures must be followed exactly to avoid any duplication of WWNNs.
- The World Wide Port Name (WWPN) of each fiber channel port do not change. The WWPNs are derived from the WWNN that is written to the replacement node as part of this procedure.

Perform the following steps to replace a node:

1. Use the command **svcinfo lsnode** to display the node name. This command, when implemented, prints a detailed list report containing information about all the nodes on a cluster. The failed node is offline. Record the nodes' name so that you can use it later.
2. Use the **svcinfo lsnode** command to display the I/O Group name. Record the name of the group for later use.
3. Use the **svcinfo lsnodevpd** command to display the front panel ID. Record the ID number for later use.
4. Use the **svcinfo lsnodevpd** command to record the UPS serial number. Record this number for later use.
5. Use the Front Panel ID to locate the failed node. Disconnect all four fiber channel cables from the node.
Important: The cables must not be reconnected until the node is repaired and the node number has been changed to the default spare node number.
6. Connect the power/signal cable from the spare node to the UPS and use the serial number you recorded in in step 1. The signal cable can be plugged into any vacant position on the top row of serial connectors on the UPS. If no spare serial connectors are available on the UPS, disconnect the cables from the failed node. Power-on the spare node. Display the node status on the service panel.

Perform these steps to change the WWNN of the node and add the replacement node:

1. With the node status displayed on the front panel, press and hold the Down button; press and release the Select button; release the Down button. The text "WWNN" is displayed on line-1 of the display. Line-2 of the display contains the last five characters of the WWNN.
2. With the WWNN displayed on the service panel, press and hold the Down button, press and release the Select button, release the Down button. This switches the display into edit mode.
3. Change the displayed number to match the WWNN recorded in step1. To edit the displayed number use the Up and Down buttons to increase or decrease the numbers displayed. Use the left and right buttons to move between fields. When the five characters match the number recorded in step1, press the select button twice to accept the number.
4. Connect the four fiber channel cables that were disconnected from the failed node to the spare node. Delete the offline node.
5. Add the spare node into the cluster. See "Adding a node back into the cluster".
6. Use the Subsystem Device Drive (SSD) management tool on the host systems to verify all paths are now online. See the *IBM System Storage SAN Volume Controller: Service Guide* menu options for further information.

When the failed node is repaired, do not connect the fibre channel cables to it. Connecting the cables might cause data corruption. Perform these steps after the failed node is repaired:

1. Display the node status on the service panel.
2. With the status displayed on the front panel, press and hold the Down button; press and release the Select button; release the Down button. The text "WWNN" is displayed on line-1 of the display; line-2 of the display contains the last five characters of the WWNN.
3. With the WWNN displayed on the service panel, press and hold the Down button, press and release the Select button, release the Down button. This switches the display into edit mode.

4. Change the displayed number to "00000". To edit the displayed number use the Up and Down buttons to increase or decrease the numbers displayed. Use the left and right buttons to move between fields. When the number is set to "00000", press the select button twice to accept the number. Never connect a node with a WWNN of "00000" to the cluster.

This error should not be marked as fixed in the error log until the failed node has been repaired and returned to the customer. If this is not done, the service technician will not be able to easily find the front panel ID of the failed node.

This node can now be used as a spare node. If this node is no longer required as a spare and is to be used for normal attachment to a cluster you must first use the procedure described above to change the WWNN to the number saved when a spare was being created. See "Prerequisites" above. Using any other number might cause data corruption.

Possible failures

- CMMVC5786E The action failed because the cluster is not in a stable state.
- CMMVC5791E The action failed because an entity that was specified in the command does not exist.
- CMMVC5794E The action failed because the node is not a member of the cluster.
- CMMVC5795E The node was not deleted because a software upgrade is in progress.
- CMMVC5796E The action failed because the I/O group that the node belongs to is unstable.
- CMMVC5797E The node was not deleted because this is the last node in the I/O group and there are virtual disks (VDisks) associated with the I/O group.
- CMMVC6252E The command failed authorization because the session SSH key is wrong or was deleted.
- CMMVC6253E The command failed authorization because the session SSH key does not have the requisite role.

An invocation example

```
svctask rmnode 1
```

The resulting output

```
No feedback
```

setclustertime

The **setclustertime** command allows you to set the time for the cluster.

Syntax

```
►► svctask — — setclustertime — — -time — time_value —————►►
```

Parameters

-time *time_value*

(Required) Specifies the time to which the cluster must be set. This must be in the following format:

```
MMDDHHmmYYYY
```

Description

This command sets the time for the cluster.

Possible failures

- CMMVC5786E The action failed because the cluster is not in a stable state.
- CMMVC6252E The command failed authorization because the session SSH key is wrong or was deleted.
- CMMVC6253E The command failed authorization because the session SSH key does not have the requisite role.

An invocation example

```
svctask setclustertime -time 040509142003
```

The resulting output

No feedback

setpwdreset

Use the **setpwdreset** command to view and change the status of the password-reset feature for the display panel.

Syntax

```
svctask setpwdreset [-disable | -enable | -show]
```

Parameters

-disable

Disables the password-reset feature that is available through the front panel menu system.

-enable

Enables the password-reset feature that is available through the front panel menu system.

-show

Displays the status of the password-reset feature, which is either enabled or disabled.

Description

The front panel menu system provides an option to reset the administrator password. This option resets the password to a random string that is displayed on the front panel. You can then use this password to access the system. You should change the password at the next login.

Issue the **svctask setpwdreset** command to view and change the status of the password-reset feature for the display panel. Passwords can consist of A - Z, a - z, 0 - 9, and underscore. Make a careful note of the admin password, because without it, you cannot access the cluster.

This command allows you access in case the administrator password is forgotten. If you leave this feature enabled, you should ensure adequate physical security to the cluster hardware.

You can view or change the status of this feature.

Possible failures

- There are no error codes.

An invocation example

```
svctask setpwdreset -show
```

The resulting output

```
Password status: [1]
```

This outcome means that the password or reset feature that is available through the front panel menu system is enabled. If the password status displayed an outcome of [0], this would mean that this feature is disabled.

settimezone

Use the **settimezone** command to set the time zone for the cluster.

Syntax

```
▶— svctask — — settimezone — — -timezone — timezone_arg —————▶
```

Parameters

-timezone *timezone_arg*

Specifies the time zone to set for the cluster.

Description

This command sets the time zone for the cluster. Use the **-timezone** parameter to specify the numeric ID of the time zone you want to set. Issue the **svcinfo lstimezones** command to list the time-zones available on the cluster. A list of valid time-zones settings are displayed in a list.

The time zone that this command sets will be used when formatting the error log produced by typing:

```
svctask dumperrlog
```

Note: If you have changed the timezone, you must clear the error log dump directory before viewing the error log through the Web application.

Issue the **svcinfo showtimezone** command to display the current time-zone settings for the cluster. The cluster ID and its associated time-zone are displayed. Issue the **svctask setclustertime** command to set the time for the cluster.

Possible failures

- CMMVC5786E The action failed because the cluster is not in a stable state.

An invocation example

```
svctask settimezone -timezone 5
```

The resulting output

```
No feedback
```

startstats

Use the **startstats** command to start the collection of statistics for both virtual disks (VDisks) and managed disks (MDisks).

Syntax

```
▶▶ svctask — — startstats — — -interval — time_in_minutes —————▶▶
```

Parameters

-interval *time_in_minutes*

Specifies the time in minutes. This is the time interval between the gathering of statistics, between 1 and 60 minutes in increments of 1.

Description

Statistics are collected at the end of each sampling period (as specified by the **-interval** parameter). These statistics are written to a file. A new file is created at the end of each sampling period. Separate files are created for MDisks, VDIsks and node statistics.

The files generated are written to the /dumps/iostats directory.

A maximum of 16 files are stored in the directory at any one time for each statistics file type, for example:

```
Nm_stats_nodepanelname_date_time  
Nv_stats_nodepanelname_date_time  
Nn_stats_nodepanelname_date_time  
m_stats_nodepanelname_date_time  
v_stats_nodepanelname_date_time
```

Statistics files beginning with **m_stats_*** and **v_stats_*** will not be written if the specified time interval is less than 15 minutes. Statistics files beginning with **Nm_stats_***, **Nv_stats_*** and **Nn_stats_*** will be written for all time intervals.

Before the 17th file (for each type) is created, the oldest file of that type is deleted.

These files can be listed by using the **svcinfolsiostatsdumps** command.

The following naming convention is used for these files:

```
stats_type_stats_nodepanelname_date_time
```

Where *stats_type* is m or Nm for MDisk, v or Nv for VDisk, and Nn for node statistics. *nodepanelname* is the current configuration node panel name, *date* is in the format of yymmdd, and *time* is in the format of hhmmss.

The following are examples of MDisk file names:

```
m_stats_000229_031123_072426
Nm_stats_000229_031123_072426
```

The following are examples of VDisk file names:

```
v_stats_000229_031123_072426
Nv_stats_000229_031123_072426
```

The following is an example of a node statistics file name:

```
Nn_stats_000229_031123_072426
```

The statistics that are collected for each MDisk and VDisk are reported in the files named *m_stats_nodepanelname_date_time* and *v_stats_nodepanelname_date_time* include the following statistical information:

- The number of SCSI read and write commands that are processed during the sample period
- The number of blocks of data that are read and written during the sample period

The statistics that are collected for each MDisk are reported in the file named *Nm_stats_nodepanelname_date_time* include the following statistical information:

- The number of SCSI read and write commands that are processed during the sample period
- The number of blocks of data that are read and written during the sample period
- Per MDisk cumulative read and write external response times in milliseconds
- Per MDisk cumulative read and write queued response times

The statistics that are collected for each VDisk are reported in the file named *Nv_stats_nodepanelname_date_time* include the following statistical information:

- The total number of SCSI read and write commands processed
- The total amount of data read and written
- Cumulative read and write response time in milliseconds
- Statistical information about the read/write cache usage
- Global Mirror statistics including latency

The statistics that are collected for the node from which the statistics file originated and are reported in the file named *Nn_stats_nodepanelname_date_time* include the following statistical information:

- Utilization figure for the node from which the statistic file was obtained
- The amount of data transferred to and received from each port on the node to other devices on the SAN.
- Statistical information about communication to other nodes on the fabric

Note: The *v_** and *m_** statistics are per-cluster statistics that are only collected on the configuration node. The *Nm_**, *Nn_** and *Nv_** files are per-node statistics that are generated on each node.

Possible failures

- There are no error codes.

An invocation example

```
svctask startstats -interval 25
```

The resulting output

```
No feedback
```

stopcluster

The **stopcluster** command allows you to shut down a single node or the entire cluster in a controlled manner. When you issue this command, you are prompted with a confirmation of intent to process the command.

Syntax

```
svctask -- stopcluster [-force] [-node node_name | node_id]
```

Parameters

-force

(Optional) This parameter must be specified if the node being shut down is the last online node in a given I/O group.

-node *node_name* | *node_id*

(Optional) Specifies the node that you want to shut down. The value that must be associated with this parameter is as follows:

- The node name, that is, the label that you assigned when you added the node to the cluster
- The node ID that is assigned to the node [not the worldwide node name.

If you supply the node ID or the name, only that node is shut down; otherwise, the entire cluster is shut down.

Description

When you enter this command without any parameters, the entire cluster is shutdown. All data is flushed to disk before the power is removed.

Attention: Ensure that you have stopped all FlashCopy, Metro or Global Mirror, and data migration operations before you attempt to shutdown a node or cluster. You should also ensure that all asynchronous deletion operations have completed prior to a shutdown operation.

When you enter this command with either a node ID or node name, the node in question is shut down. After the command completes, the other node in the I/O group destages the contents of its cache and goes into write-through mode until the power to the node is returned and the node rejoins the cluster.

If all input power to a cluster is to be removed for more than a few minutes, (for example, if the machine room power is to be shutdown for maintenance), it is important that the cluster is shutdown before the power is removed. The reason for this is that if the input power is removed from the uninterruptible power supply units without first shutting down the cluster and the uninterruptible power supplies, the uninterruptible power supply units remain operational and eventually become drained of power.

When input power is restored to the uninterruptible power supplies they begin to recharge but the nodes do not permit any I/O activity on the virtual disks until the uninterruptible power supply is charged enough to enable all the data on the nodes to be saved in the event of an unexpected power loss. This might take as long as three hours. Shutting down the cluster prior to removing input power to the uninterruptible power supply units prevents the draining of battery power and makes it possible for I/O activity to resume as soon as input power is restored.

Attention: Before shutting down a node or the cluster you should quiesce all I/O operations that are destined for this node or cluster. Failure to quiesce can result in failed I/O operations being reported to your host operating systems.

Begin the process of quiescing all I/O to the cluster by stopping the applications on your hosts that are using the VDisks provided by the cluster.

1. If you are unsure which hosts are using the VDisks provided by the cluster, follow the procedure called, Determining the hosts that a VDisk is mapped to.
2. Repeat the previous step for all VDisks.

Attention: If you are shutting down the entire cluster, you lose access to all VDisks being provided by this cluster.

When all I/O has been stopped, issue the **svctask stopcluster** to shut down a single node or the entire cluster in a controller manner. If you specify the node ID or node name, you can shut down a single node. After the command completes, the other node in the I/O group destages the contents of its cache and goes into write-through mode until the power to the node is returned and the node rejoins the cluster.

Attention: If this is the last node in an I/O group, you must specify the **-force** parameter. You will lose all access to the virtual disks in the I/O group. Before you enter this command, ensure that this is what you want to do.

If a shutdown command has been sent to the cluster and both cluster and uninterruptible power supply units have powered off, when input power is restored it will be necessary to restart the uninterruptible power supply units by pressing the power button on the uninterruptible power supply front panel.

Ensure that you have stopped all FlashCopy mappings and Metro or Global Mirror relationships. In addition, ensure that all data migration operations and forced deletions have completed before continuing. Entering **y** to the confirmation message processes the command. No feedback is then displayed. Entering anything other than **y** or **Y** results in the command not processing. No feedback is displayed.

Shutting down a single node:

Attention: If you are shutting down a single node and the other node in the I/O group is online, be aware that the cache on the partner node goes into the write-through mode and that you are exposed to a single point of failure if the partner node fails while the node is shut down. You also lose access to all VDIs being served by this I/O group.

Possible failures

- CMMVC5786E The action failed because the cluster is not in a stable state.
- CMMVC5798E The action failed because the node is offline.
- CMMVC5791E The action failed because an entity that was specified in the command does not exist.
- CMMVC5796E The action failed because the I/O group that the node belongs to is unstable.
- CMMVC5799E The shutdown was not successful because there is only one online node in the I/O group.
- CMMVC6252E The command failed authorization because the session SSH key is wrong or was deleted.
- CMMVC6253E The command failed authorization because the session SSH key does not have the requisite role.

An invocation example

```
svctask stopcluster
```

The resulting output You will be presented with the following warning:

```
Are you sure that you want to continue with the shut down?
```

stopstats

You can use the **stopstats** command to stop the collection of statistics for both VDIs and MDIs.

Syntax

```
svctask stopstats
```

Description

This command turns off the statistics generation, until you start them again (with **svctask startstats**).

Possible failures

- There are no error codes.

An invocation example

```
svctask stopstats
```

The resulting output

```
No feedback
```

Chapter 8. Backup and restore commands

The following commands are used for backing up and restoring configuration information with the SAN Volume Controller.

backup

Use the **backup** command to backup your configuration. You can enter this command any time after a cluster has been created.

Syntax

```
svsconfig -- backup [-quiet] [-v on | off]
```

Parameters

-quiet

Suppresses standard output (STDOUT) messages from the console.

-v on | off

On means verbose messages will be displayed. Off means normal messages (the default) will be displayed.

Description

The **backup** command extracts configuration data from the cluster and saves it to "svc.config.backup.xml" in "/tmp". A file "svc.config.backup.sh" is also produced. This can be studied to see what other commands have been issued to extract information. A log "svc.config.backup.log" is also produced. This can be studied for detail as to what has been done and when. This log also includes information on the other commands issued.

Any preexisting file "svc.config.backup.xml" is archived as "svc.config.backup.bak". (Only one such archive is kept.)

It is recommended that the ".xml" file and related ".key" files (see limitations below) be immediately moved off-cluster for archiving, and then the files erased from "/tmp" using the **clear** command. It is strongly recommended that all objects having default names be changed to have non-default names, as objects with default names cannot be restored faithfully.

The prefix "_" (underscore) is reserved for backup and restore command usage, and should not be used in any object names.

The **backup** command has the following limitations:

- ".key" SSH public key value files are not produced to go along with the ".xml" file in "/tmp". Warnings will nevertheless be issued for the missing file or files that should be supplied by the user. These will conform to the template "svc.config.identifier.user.key" where *identifier* and *user* are as specified for the **addsshkey** command. You are requested to supply these files if they were used with the **addsshkey** command. If they are not available, then it will be necessary

to install a new set of keys during the cluster restoration process, assuming that cluster restoration is necessary at some time in the future.

Possible failures

- CMMVC6112W *object-type object-name* has a default name
- CMMVC6136W No SSH key file *file-name*
- CMMVC6147E *object-type object-name* has a name beginning with *prefix*

An invocation example

```
svcconfig backup
```

The resulting output

```
No feedback
```

clear

Use the **clear** command to erase files in the `/tmp` directory previously produced by other `svcconfig` commands. You can enter this command any time after a cluster has been created.

Syntax

```
▶▶ svcconfig -- clear -- -all ▶▶
```

Parameters

-all

Includes `.key`, `.bak` and `.xml` files in file clearance; otherwise, clears just `.log` and `.sh` files. The `.key`, `.bak` and `.xml` files contain configuration information, whereas the others do not.

Description

This command clears some or all files in the `/tmp` directory produced by `svcconfig`. Files conform to the template `svc.config.*`.

Possible failures

- CMMVC6103E Problem file *file-name*: *details*

An invocation example

```
svcconfig clear -all
```

The resulting output

```
No feedback
```

help

Use the **help** command to obtain summary information about the syntax of `svcconfig`. You can enter this command any time after a cluster has been created.

Syntax

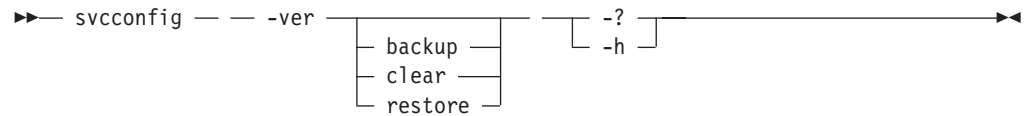

Parameters

-h | -?

Provides general help.

(action) -h | -?

Provides command help: the possible values for (action) are backup, clear, and restore.

-ver

Returns the version number for the **svcconfig** command.

Description

This command provides syntax help for **svcconfig**.

Possible failures

- CMMVC6100E *-option* not consistent with *action*
- CMMVC6101E *-option* not consistent with *-option*
- CMMVC6102E *-option* and *-option* are alternatives
- CMMVC6114E No help for action *action*
- CMMVC6134E No argument for *-option*
- CMMVC6135E Argument *value* for *-option* is not valid
- CMMVC6138E *-option* is required
- CMMVC6141E *-option* does not contain any argument
- CMMVC6149E An action is required
- CMMVC6150E The action *action* is not valid
- CMMVC6151E The option *-option* is not valid
- CMMVC6153E *object* not consistent with *action*

An invocation example

```
svcconfig -ver  
svcconfig -?  
svcconfig backup -h
```

The resulting output

Help text.

restore

Use the **restore** command to take information from configuration files in the `"/tmp"` directory and restore the cluster to that configuration. You can only enter this command immediately after a cluster has been created.

Syntax

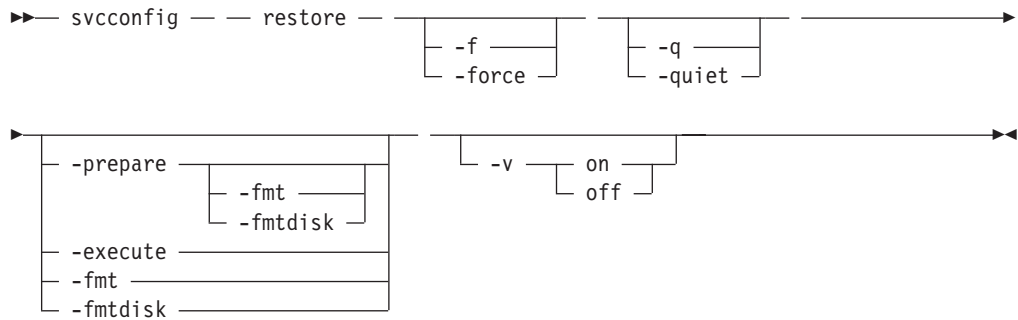

Parameters

-f | force

Forces continued execution where possible.

-q | quiet

Suppresses console output (STDOUT).

-prepare

Checks the current configuration against the information held in "svc.config.backup.xml" on the configuration to be restored. Prepares commands for execution in "svc.config.restore.sh", and produces a log of events in "svc.config.restore.prepare.log".

-fmt | fmtdisk

Includes the -fmtdisk option on all **mkvdisk** commands to be issued.

-execute

Executes the command script "svc.config.restore.sh". Produces a log of events in "svc.config.restore.execute.log".

-v on | off

Produces verbose output (on); the default is regular output (off).

Description

This command restores the target cluster configuration from the "svc.config.backup.xml" file, and associated ".key" files (if present) in the configuration files directory. If neither the "prepare" nor "-execute" option is specified, then only a single event log "svc.config.restore.log" is produced.

This command will pause for 5 minutes if any nodes are added during this process. You will be informed of this at run-time.

After restoration, a VDisk will comprise a specific list of MDisk. If the relevant MDisk group comprises a larger list, either now or in the future, the restored VDisk will not be able to exploit any MDisk that are not presently in its own list.

The configuration files directory is "/tmp."

Possible failures

- CMMVC6105E Different names for source *name* and target *name* clusters
- CMMVC6106E Target cluster has non-default *id_alias value*
- CMMVC6107E *x* *io_grp* objects in target cluster; *y* are required

- CMMVC6109E Disk controller system with WWNN of *value* not available
- CMMVC6120E Target is not the configuration node
- CMMVC6139E Incorrect XML tag nesting in *file-name*
- CMMVC6142E Existing *object-type object-name* has a non-default name
- CMMVC6143E Required configuration file *file-name* does not exist
- CMMVC6146E Problem parsing *object-type* data: *line*
- CMMVC6147E *object-type object-name* has a name beginning with *prefix*
- CMMVC6148E Target cluster has *actual* object(s) of type *object-type* instead of *required*
- CMMVC6152E vdisk *name* instance number *value* is not valid
- CMMVC6155I SVCCONFIG processing completed successfully
- CMMVC6156W SVCCONFIG processing completed with errors
- CMMVC6165E Target is not the original configuration node with WWNN of *value*

Note: Messages 6155 and 6156 are only shown with "-v on".

An invocation example

```
svcconfig restore -prepare  
svcconfig restore -execute
```

The resulting output

No feedback

Chapter 9. Cluster diagnostic and service-aid commands

Cluster diagnostic and service-aid commands are designed to diagnose and find cluster problems.

The SAN Volume Controller enables service activity to be performed with a limited set of command-line tools. When you are logged in under the administrator role, all command-line activities are permitted. When you are logged in under the service role, only those commands required for service are enabled. All of these commands apply under the service role. The service commands permit problem determination and repair activities to be performed.

addnode

The **addnode** command allows you to add a new (candidate) node to an existing cluster. You can enter this command any time after a cluster has been created.

Syntax

```
▶▶▶ svc servicetask — — addnode — — [ -panelname — — panel_name ] — —▶▶▶
                                     [ -wwnodename — — wwnn_arg ]
▶ [ -name — — new_name_arg ] — — -iogrp — — [ iogroup_name ] — —▶▶▶
                                     [ iogroup_id ]
```

Parameters

-panelname *panel_name*

(Required) Specifies the node that you want to add to the cluster, by its name, that appears on the display panel.

Note: You cannot use the **-panelname** parameter with the **-wwnodename** parameter. However, you must use one of these parameters with the **addnode** command.

-wwnodename *wwnn_arg*

(Required) Specifies the node you want to add to the cluster by the worldwide node name (WWNN) of the node.

Note: You cannot use the **-wwnodename** parameter with the **-panelname** parameter. However, you must use one of these parameters with the **addnode** command.

-name *new_name_arg*

(Optional) Specifies a name for the designated node.

-iogrp *iogroup_name* | *iogroup_id*

(Required) Specifies the I/O group to which you want to add this node.

Description

This command adds a new node to the cluster. You can obtain a list of candidate nodes (those that are not already assigned to a cluster) by issuing the **svcinfo lsnodecandidate** command.

The process of adding a node completes asynchronously. This means that while the node is in adding state, the WWPN is not known and displays as zeroes.

If the compatibility check fails, the following message displays:

```
CMMVC6201E The node could not be added, because incompatible
software: status code [%1].
```

Prerequisites: Before you can add a node to the cluster, check the following:

- The cluster has more than one I/O group.
- The node being added to the cluster uses physical node hardware that has previously been used as a node in the cluster.
- The node being added to the cluster uses physical node hardware which has previously been used as a node in another cluster and both clusters have visibility of the same hosts.

Attention: If the conditions listed above apply, then failure to follow the procedures documented here, can result in the corruption of all data managed by the cluster.

Adding a node: If you are adding the node into the cluster for the first time, you must record the node serial number, the WWNN, all WWPN's, and the I/O group to which it has been added. This can prevent possible data corruption if the node must be removed from and re-added to the cluster.

When a node is added to the cluster using the `svctask addnode` command or the cluster GUI, confirm that the node has previously been a member of the cluster. If it has, follow one of these two procedures:

- The node must be added back to the same I/O group that it was previously in. The WWNN of the nodes in the cluster can be determined using the `svcinfolsnode` command. Or,
- If this information is not available, call the support team to add the node back into the cluster without corrupting the data.

Optionally, you can assign a name to the new node. You can use this name in subsequent commands to refer to the node, instead of using the node ID. If you assign a label, this label is displayed as the node name from then on. If you do not assign a label, the default label is nodeX, where X is the node ID.

Applications on a host system direct I/O operations to file systems or logical volumes that are mapped by the operating system to vpaths. Vpaths are pseudo disk objects supported by the SDD driver. See the *Multipath Subsystem Device Driver: User's Guide* for more information.

The SDD driver maintains an association between a vpath and a VDisk. This association uses an identifier (UID), which is unique to the VDisk and is not reused. This enables the SDD driver to unambiguously associate vpaths with VDisks.

The SDD device driver operates within a protocol stack, which also contains disk and fibre-channel device drivers that enable it to communicate with the cluster using the SCSI protocol over fibre-channel as defined by the ANSI FCS standard. The addressing scheme provided by these SCSI and fibre-channel device drivers uses a combination of a SCSI logical unit number (LUN) and the worldwide name for the fibre-channel node and ports.

In the event that errors occur, error recovery procedures (ERPs) operate at various tiers in the protocol stack. Some of these ERPs cause I/O to be redriven using the same WWNN and LUN numbers that were previously used.

The SDD device driver does not check the association of the VDisk with the vpath on every I/O operation that it performs.

Possible failures

- CMMVC5707E Required parameters are missing.
- CMMVC5786E The action failed because the cluster is not in a stable state.
- CMMVC5790E The node was not added to the cluster because the maximum number of nodes has been reached.
- CMMVC5791E The action failed because an entity that was specified in the command does not exist.
- CMMVC5792E The action failed because the I/O group is used for recovery.
- CMMVC5793E The node was not added to the cluster because the I/O group already contains a pair of nodes.
- CMMVC5777E The node was not added to the I/O group because the other node in the I/O group is in the same power domain.
- CMMVC6201E The node could not be added, because incompatible software: status code [%1].
- CMMVC6252E The command failed authorization because the session SSH key is wrong or was deleted.
- CMMVC6253E The command failed authorization because the session SSH key does not have the requisite role.

An invocation example

```
svcservicetask addnode -wwnodename 210000e08b053564 -iogrp io_grp0
```

The resulting output

```
Node, id [6], successfully added
```

applysoftware

The **applysoftware** command upgrades the cluster to a new level of software.

Syntax

```
▶▶— svcservicetask — — applysoftware — [ -force ] —————▶▶
▶— -file — filename_arg — [ -abort ] —————▶▶
```

Parameters

-force

(Optional) Specifies that the upgrade continue even if there is a node in the I/O group that is not paired. The upgrade process forces the first node in each I/O group to shut down and upgrade.

Note: If the first node in the I/O group is not paired, the cluster becomes degraded and the data is lost even with the use of the **-force** parameter.

| **-file filename_arg | -abort**

| (Required) Specifies that if you are doing an upgrade, you must designate the
| file name of the new software package.

| To stop the upgrade and back out to where the application was before you
| started the upgrade, you must specify the **-abort** parameter.

| **Note:** The **-force** parameter can be used with the **-abort** parameter. If one or
| more nodes are offline, processing the **-abort** parameter fails unless the
| **-force** parameter is used.

Description

This command starts the upgrade process of the cluster to a new level of software and applies to **svcservicetask** and **svcservicemodetask**. The **applysoftware** command can be used to apply a level of software to the node in both service and nonservice modes. In service mode, the **applysoftware** command is applied to the specific node. In nonservice mode, the **applysoftware** command is applied to the entire cluster.

The software package as specified by the file name must first be copied on to the current configuration node in the `/home/admin/upgrade` directory. You can use PuTTY secure copy (`scp`) to copy the file. See “PuTTY scp” for detailed information on this procedure.

The actual upgrade completes asynchronously.

The **svcinfolsoftwareumps** command allows you to view the contents of the `/home/admin/upgrade` directory.

Internally, the new package will be moved from the `/home/admin/upgrade` directory and checksummed. If the package fails the checksum, it is deleted and the upgrade fails. Otherwise, the package is extracted from the directory and the software upgrade begins.

Possible failures

- CMMVC5801E The upgrade of the cluster software could not proceed because every node in the cluster must be online. Either delete the node that is offline or bring the node online and resubmit the command.
- CMMVC5802E The upgrade of the cluster software could not proceed because there is an I/O group in the cluster that contains only one node. The software upgrade requires that each node in an I/O group be shut down and restarted. If there is only one node in an I/O group, I/O operations could be lost if I/O operations are not stopped before beginning the software upgrade. To upgrade the cluster, the force parameter is required.
- CMMVC5993E The specific upgrade package does not exist.
- CMMVC5994E Error in verifying the signature of the upgrade package.
- CMMVC5995E Error in unpacking the upgrade package.
- CMMVC5996E The specific upgrade package cannot be installed over the current version.
- CMMVC6011E At least one remote cluster partnership has been found. This upgrade package cannot be applied to the current code level until all remote cluster partnerships are deleted.
- CMMVC6054E The action failed as not all nodes are online.

- CMMVC6206E The software upgrade failed as a file containing the software for the specified version was not found.
- CMMVC6232E This operation cannot be performed because the cluster is currently aborting the previous software upgrade command.
- CMMVC6233E This operation cannot be performed because the software upgrade is making progress.

An invocation example

```
svcservicetask applysoftware -file softwareupdate
```

The resulting output

No feedback

cherrstate

The **cherrstate** command marks an unfixed error as fixed. You can also use it to mark a fixed error as unfixed.

Syntax

```
svctask — cherrstate — -sequencenumber — sequence_number —  
└─ -unfix ─┘
```

Parameters

-sequencenumber *sequence_number*

(Required) Specifies the error log sequence numbers to fix or to mark as unfixed.

-unfix

(Optional) Specifies that the sequence numbers be marked as unfixed. Use this parameter when you have marked the wrong sequence number as fixed.

Description

The error log entries that the sequence numbers that you entered are marked as fixed. Use this command as a manual confirmation step that you have performed a maintenance procedure on the cluster, fabric, or subsystems.

This step is performed as part of the directed maintenance procedures (DMPs).

Optionally, if you have wrongly marked a sequence number as fixed, you can use the **-unfix** parameter to change the entry to unfixed.

Possible failures

- CMMVC5786E The action failed because the cluster is not in a stable state.
- CMMVC5803E The entry in the error log was not marked because the sequence number was not found.
- CMMVC6252E The command failed authorization because the session SSH key is wrong or was deleted.
- CMMVC6253E The command failed authorization because the session SSH key does not have the requisite role.

An invocation example

```
svctask cherrstate -sequencenumber 2019
```

The resulting output

No feedback

clearerrlog

The **clearerrlog** command clears all entries from the error log including status events and any unfixed errors.

Syntax

```
svctask -- clearerrlog -- [-force]
```

Parameters

-force

(Optional) Specifies that the **clearerrlog** command be processed without confirmation requests. If the **-force** parameter is not supplied, you are prompted to confirm that you want to clear the log.

Description

This command clears all entries from the error log. The entries are cleared even if there are unfixed errors in the log. It also clears any status events that are in the log.

Attention: This command is destructive. Use it only use when you have either rebuilt the cluster or have fixed a major problem that has caused entries in the error log that you do not want to manually fix.

Possible failures

- CMMVC5786E The action failed because the cluster is not in a stable state.
- CMMVC6252E The command failed authorization because the session SSH key is wrong or was deleted.
- CMMVC6253E The command failed authorization because the session SSH key does not have the requisite role.

An invocation example

```
svctask clearerrlog -force
```

The resulting output

No feedback

dumperrlog

The **dumperrlog** command dumps the contents of the error log to a text file.

Syntax

►► svctask — — dumperrlog — — [-prefix — filename_prefix]

Parameters

-prefix *filename_prefix*

A file name is created from the prefix and a time stamp, and has the following format:

<prefix>_NNNNNN_YMMDD_HHMMSS

where *NNNNNN* is the node front panel name.

Note: If the `-prefix` parameter is not supplied, the dump will be directed to a file with a system-defined prefix of "errlog".

Description

When executed with no arguments, this command dumps the cluster error log to a file using a system-supplied prefix of "errlog", which includes the node ID and time stamp. When a file name prefix is provided, the same operation is performed but the details are stored in the dumps directory within a file with a name that starts with the specified prefix.

A maximum of ten error-log dump files are kept on the cluster. When the 11th dump is made, the oldest existing dump file is overwritten.

Error log dump files are written to `/dumps/elogs`. The contents of this directory can be viewed using the `svcinfolerrlogdumps` command.

Files **will not** be deleted from other nodes until you issue the `cleardumps` command.

Possible failures

- CMMVC5983E The dump file was not created. The file system might be full.
- CMMVC5984E The dump file was not written to disk. The file system might be full.

An invocation example

```
svcservicetask dumperrlog -prefix testerrorlog
```

The resulting output

No feedback

finderr

The `finderr` command analyzes the error log for the highest severity unfixed error.

Syntax

►► svctask — — finderr — —

Description

The command scans the error log for any unfixed errors. Given a priority ordering defined within the code, the highest priority unfixed error is returned to stdout.

You can use this command to determine the order in which to fix the logged errors.

The Web-based directed maintenance procedures (DMPs) also use this command.

Possible failures

- There are no error codes.

An invocation example

```
svctask finderr
```

The resulting output

```
Highest priority unfixed error code is [1010]
```

rmnode

The **rmnode** command deletes a node from the cluster. You can enter this command any time after a cluster has been created.

Syntax

```
▶▶— svcservicetask — — rmnode — — node_name —————▶▶  
                                └── node_id ───┘
```

Parameters

node_name | node_id

Specifies the node to be deleted. The argument is either:

- The node name, that is, the label that you assigned when you added the node to the cluster
- The node ID that is assigned to the node [not the worldwide node name (WWNN)].

Description

This command removes a node from the cluster. This makes the node a candidate to be added back into this cluster or into another cluster. After the node is deleted, the other node in the I/O group destages the contents of its cache and goes into write-through mode until another node is added back into the I/O group.

Prerequisites:

Before you issue the **rmnode** command, perform the following tasks and read the following Attention notices to avoid losing access to data:

1. Determine which virtual disks (VDisks) are still assigned to this I/O group by issuing the following command. The command requests a filtered view of the VDisks, where the filter attribute is the I/O group.

```
svcinfolsvdisk -filtervalue IO_group_name=<name>
```

where <name> is the name of the I/O group in question.

Note: Any VDIsks that are assigned to the I/O group that this node belongs to, will be assigned to the other node in the I/O group; that is, the preferred node will be changed. You cannot change this setting back.

2. Determine the hosts that the VDIsks are mapped to by issuing the **svcinfolsvdiskhostmap** command.
3. Determine if any of the VDIsks assigned to this I/O group contain data that you need to maintain access to:
 - If you *do not* want to maintain access to these VDIsks, go to step 5.
 - If you *do* want to maintain access to some or all of the VDIsks, back up the data or migrate the data to a different (online) I/O group.
4. Determine if you need to turn the power off to the node:
 - If this is the last node in the cluster, you do not need to turn the power off to the node. Go to step 5.
 - If this is *not* the last node in the cluster, turn the power off to the node that you intend to remove. This step ensures that the Subsystem Device Driver (SDD) does not rediscover the paths that are manually removed before you issue the delete node request.
If you plan to add the node back into the cluster, see **Adding a node back into the cluster:** below.
5. Update the SDD configuration for each virtual path (vpath) that is presented by the VDIsks that you intend to remove. Updating the SDD configuration removes the vpaths from the VDIsks. Failure to update the configuration can result in data corruption. See the *Multipath Subsystem Device Driver: User's Guide* for details about how to dynamically reconfigure SDD for the given host operating system.
6. Quiesce all I/O operations that are destined for the node you are deleting. Failure to quiesce the operations could result in failed I/O operations being reported to your host operating systems.

Attention: Removing the last node in the cluster destroys the cluster. Before you delete the last node in the cluster, ensure that you want to destroy the cluster.

Attention: If you are deleting a single node and the other node in the I/O group is online, the cache on the partner node will go into write-through mode, causing the data to be exposed to a single point of failure if the partner node fails.

Note:

1. If the node you are removing is the configuration node, it may take one or two minutes to complete the command.
2. If the node you are removing is the last node in the cluster, the cluster might seem to hang for up to 3 minutes because you have removed the last access point to the cluster.

Deleting a node from a cluster:

Note:

1. If this is the last node in the I/O group or the last node in the cluster, you will be asked to force the deletion.
2. If this is the last node in the cluster or if it is currently assigned as the configuration node, all connections to the cluster will be lost. The user

interface and any open CLI sessions will be lost if last node in the cluster is deleted. Deleting the configuration node results in the CLI failing over to another node. A time-out might occur if a command cannot be completed before the node is deleted.

Issue the **svctask rmnode** command to delete a node from the cluster. You can enter this command any time after a cluster has been created.

Adding a node back into the cluster:

If you turn the power back on to the node that has been removed while it is still connected to the same fabric or zone, the following actions occur:

1. The node attempts to join the cluster again.
2. The cluster signals the node to remove itself from the cluster.
3. The node becomes a candidate for addition to this cluster or another cluster.

If you intend to add this node back into the cluster, ensure that you add it back to the same I/O group from which you are deleting it. Otherwise, data corruption might occur.

Before you add a node back into the cluster, you need to know the following information, which should have been recorded when the node was originally added to the cluster.

- Node serial number
- WWNN
- All worldwide port names (WWPNs)
- I/O group that contains the node

If you do not have access to this information, call the service team to add the node back into the cluster without corrupting the data.

Replacing a faulty node:

You can replace a failed node with a “spare” or replacement node. This would be necessary if the node fails. The cluster will continue to operate with degraded performance until the failed node is repaired. To enhance availability, you might choose to replace the failed node with a “spare”, then repair the node offline. However, various procedures must be followed and precautions taken, to replace a failed node without interrupting I/O and without risk to data integrity when the repaired node is reconnected to the SAN fabric. The procedure involves changing the WWNN of the replacement node. This procedure must be followed with care to avoid duplicate WWNNs which are illegal and can cause data corruption.

Prerequisites:

Before replacing the failed node you must:

- Ensure that the GUI that is used to access the cluster and spare node is running at least version 1.1.1 of the software.
- Know the cluster name that contains the failing node.
- Confirm that a spare node is in the same rack as the cluster containing the failed node.
- Make a record of the last five characters of the original WWNN. This identification is needed if you decide in the future to designate the spare node as a normal node that can be assigned to any cluster. Use the **svcinfolnode** command to see the WWNN.

Additional Information

When you replace a node, the following process takes place:

- The node Front Panel ID will change. This is the number printed on the front of the node, used to select the node that is to be added to a cluster.
- The Node Name might change. If you permit the cluster to assign default names when adding nodes to the cluster it will create a new name each time a node is added. If you choose to assign your own names then you must type in the node name that you want to use. If you are using scripts to perform management tasks on the cluster and those scripts use the Node Name then by assigning the original name to a replacement node you will avoid the need to make changes to the scripts following service activity on the cluster.
- The Node ID will change. A new Node ID is assigned each time a node is added to a cluster. The Node ID or the Node Name can be used when performing management tasks on the cluster but if scripts are being used to perform those tasks it is recommended that the Node Name is used in preference to the Node ID since the Node Name will remain unchanged following service activity on the cluster.
- The World Wide Node Name (WWNN) will not change. The WWNN is used to uniquely identify the node and the fiber channel ports. The node replacement procedure changes the WWNN of the spare node to match that of the failed node. The node replacement procedures must be followed exactly to avoid any duplication of WWNNs.
- The World Wide Port Name (WWPN) of each fiber channel port will not change. The WWPNs are derived from the WWNN that is written to the replacement node as part of this procedure.

Perform the following steps to replace a node:

1. Use the command **svcinfo lsnode** to display the node name. This command, when implemented, prints a detailed list report containing information about all the nodes on a cluster. The failed node will be offline. Note the nodes' name.
2. Again use **svcinfo lsnode** to display the I/O Group name. Note the name of the group.
3. Use the command **svcinfo lsnodevpd** to display the front panel id. Note the id number.
4. Again use the command **svcinfo lsnodevpd** to record the UPS serial number. Note this number.
5. Use the Front Panel ID to locate the failed node. Disconnect all four fiber channel cables from the node.
Important: The cables must not be reconnected until the node is repaired and the node number has been changed to the default spare node number.
6. Connect the power/signal cable from the spare node to the UPS with the serial number noted in step 1. The signal cable can be plugged into any vacant position on the top row of serial connectors on the UPS. If no spare serial connectors are available on the UPS, disconnect the cables from the failed node. Power-on the spare node. Display the node status on the service panel.

Perform these steps to change the WWNN of the node and add the replacement node:

1. With the node status displayed on the front panel, press and hold the Down button; press and release the Select button; release the Down button. The text “WWNN” is displayed on line-1 of the display. Line-2 of the display contains the last five characters of the WWNN.
2. With the WWNN displayed on the service panel, press and hold the Down button, press and release the Select button, release the Down button. This switches the display into edit mode.
3. Change the displayed number to match the WWNN recorded in step 1. To edit the displayed number use the Up and Down buttons to increase or decrease the numbers displayed. Use the left and right buttons to move between fields. When the five characters match the number recorded in step 1, press the select button twice to accept the number.
4. Connect the four fiber channel cables that were disconnected from the failed node to the spare node. Delete the offline node.
5. Add the spare node into the cluster. See “Adding a node back into the cluster”.
6. Use the Subsystem Device Drive (SSD) management tool on the host systems to verify all paths are now online. See the *IBM System Storage SAN Volume Controller: Service Guide* menu options for further information.

When the failed node is repaired do not connect the fibre channel cables to it. Connecting the cables might cause data corruption. Perform these steps after the failed node is repaired:

1. Display the node status on the service panel.
2. With the status displayed on the front panel, press and hold the Down button; press and release the Select button; release the Down button. The text “WWNN” is displayed on line-1 of the display; line-2 of the display contains the last five characters of the WWNN.
3. With the WWNN displayed on the service panel, press and hold the Down button, press and release the Select button, release the Down button. This switches the display into edit mode.
4. Change the displayed number to “00000”. To edit the displayed number use the Up and Down buttons to increase or decrease the numbers displayed. Use the left and right buttons to move between fields. When the number is set to “00000”, press the select button twice to accept the number. Never connect a node with a WWNN of “00000” to the cluster.

This error should not be marked as fixed in the error log until the failed node has been repaired and returned to the customer. If this is not done, the service technician will not be able to easily find the front panel ID of the failed node.

This node can now be used as a spare node. If this node is no longer required as a spare and is to be used for normal attachment to a cluster you must first use the procedure described above to change the WWNN to the number saved when a spare was being created. See “Prerequisites” above. Using any other number might cause data corruption.

Possible failures

- CMMVC5786E The action failed because the cluster is not in a stable state.
- CMMVC5791E The action failed because an entity that was specified in the command does not exist.
- CMMVC5794E The action failed because the node is not a member of the cluster.
- CMMVC5795E The node was not deleted because a software upgrade is in progress.

- CMMVC5796E The action failed because the I/O group that the node belongs to is unstable.
- CMMVC5797E The node was not deleted because this is the last node in the I/O group and there are virtual disks (VDisks) associated with the I/O group.

An invocation example

```
svcservicetask rmnode 1
```

The resulting output

No feedback

setevent

The **setevent** command specifies what happens when an error or event is logged to the error log.

Syntax

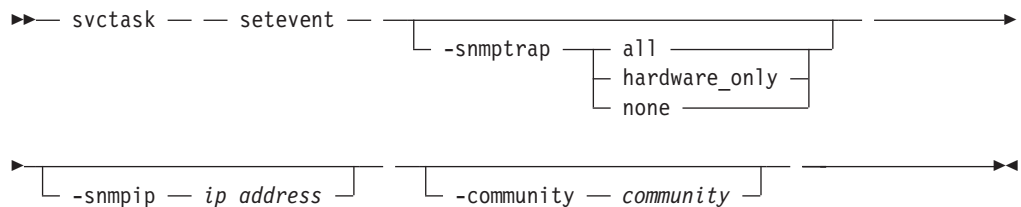

Parameters

-snmptrap *all | hardware_only | none*

(Optional) Specifies the SNMP trap setting, that is, when to raise a trap. You can set the following values for this parameter:

all Sends an SNMP trap for all errors and state changes that are logged.

hardware_only

Sends an SNMP trap for all errors, but not for object state changes.

none Does not send any SNMP traps or errors. This is the default setting for a new cluster.

-snmpip *ip_address*

(Optional) Specifies the IP address of the host system that is running the SNMP manager software. This is a colon-separated list of values with up to six items per list.

-community *community*

(Optional) Specifies the SNMP community string. This is a colon-separated list of values with up to six items per list. The maximum length of the community string that is used in SNMP trap generation cannot be more than 60 characters.

Description

This command sets or modifies the settings that you want to apply to the error log. These settings define what to do when errors and events are logged.

You can use this command to setup SNMP traps. For SNMP, you must supply the following information:

- When to raise a trap.
- The IP address of the SNMP manager
- The SNMP community

Possible failures

- CMMVC5786E The action failed because the cluster is not in a stable state.
- CMMVC6252E The command failed authorization because the session SSH key is wrong or was deleted.
- CMMVC6253E The command failed authorization because the session SSH key does not have the requisite role.

An invocation example

```
svctask setevent -snmptrap all -snmpip 1.2.3.4
-community mysancommunity
```

The resulting output

No feedback

setlocale

The **setlocale** command changes the locale setting for the cluster. It also changes all interfaces output to the chosen language.

Syntax

```
▶▶ svcservicetask — — setlocale — — -locale — locale_id —————▶▶
```

Parameters

-locale *locale_id*
Specifies the locale ID.

Description

This command changes the language in which error messages are displayed as output from the command-line interface. After this, all error messages from the command-line tools will be generated in the chosen language. This command is executed when you request a change of language (locale) and is generally executed from the Web page. Issue the **svcservicetask setlocale** command to change the locale setting for the cluster. It changes all interfaces output to the chosen language. For example, if you wanted to change the English default language to Japanese, type the following:

```
svcservicetask setlocale -locale 3
```

where 3 is the argument that stands for Japanese. The arguments are:

- 0 US English (default)
- 1 Chinese (simplified)
- 2 Chinese (traditional)
- 3 Japanese
- 4 Korean
- 5 French

- 6 German
- 7 Italian
- 8 Spanish
- 9 Portuguese (Brazilian)

Note: This command does not change the front panel display panel settings.

Possible failures

- There are no error codes.

An invocation example

```
svcservicetask setlocale -locale 3
```

The resulting output

No feedback

svqueryclock

The **svqueryclock** command returns the date, time, and current time-zone of the cluster.

Syntax

```
▶▶ svqueryclock ◀◀
```

Description

This command returns the date, time and current time-zone of the cluster.

Possible failures

- There are no error codes.

An invocation example

```
svqueryclock
```

The resulting output

```
Mon Nov 25 14:59:28 GMT 2002
```

writesernum

Use the **writesernum** command to write the node serial number into the planar NVRAM.

Syntax

```
▶▶ svcservicetask — — writesernum — — -sernum — serial_number — —▶▶
  └─┬─ node_id ─┬───▶▶
    │   node_name
```

Parameters

-sernum *serial_number*

Specifies the serial number you want to write to the nonvolatile memory of the system planar.

node_id | node_name

Specifies the node where the system planar is located. The serial number will be written to this system planar. This name is not the worldwide node name (WWNN).

Description

This command writes the node serial number into the planar NVRAM and then reboots the system. You can find the serial number at the front of the node without having to remove it from the rack. The serial number is located to the left of the right-side thumbscrew that holds the node into the rack. This serial number will usually be seven digits.

Note: Once you have written the serial number to the planar NVRAM, you can issue the **svcinfo lsnodevpd** command to verify that the number is correct. The `system_serial_number` field contains the serial number.

Possible failures

- CMMVC5786E The action failed because the cluster is not in a stable state.
- CMMVC5791E The action failed because an entity that was specified in the command does not exist.
- CMMVC5794E The action failed because the node is not a member of the cluster.

An invocation example

```
svcservicetask writesernum -sernum 1300027 node1
```

The resulting output

No feedback

Chapter 10. Host commands

The following commands enable you to work with host options with the SAN Volume Controller.

addhostiogr

The **addhostiogr** command enables you to map I/O groups to an existing host object.

Syntax

```
svctask -- addhostiogr -- [-iogrp -- iogrp_list] -- host_id_or_name
```

The diagram shows the command structure: `svctask` followed by a long dash, then `addhostiogr` followed by a long dash. A bracket groups the optional parameters `-iogrp` and `-iogrpall`, with `iogrp_list` as the value for `-iogrp`. This is followed by another long dash and the required parameter `host_id_or_name`.

Parameters

-iogrp *iogrp_list*

(Required if you do not use **-iogrpall**) Specifies a colon-separated list of one or more I/O groups that must be mapped to the host. You cannot use this parameter with the **-iogrpall** parameter.

-iogrpall

(Required if you do not use **-iogrp**) Specifies that all the I/O groups must be mapped to the specified host. You cannot use this parameter with the **-iogrp** parameter.

host_id_or_name

(Required) Specifies the host either by ID or by name to which the I/O groups must be mapped.

Description

This command allows you to map the list of I/O groups to the specified host object.

Possible failures

- CMMVC5786E The action failed because the cluster is not in a stable state.
- CMMVC5874E The action failed because the host does not exist.
- CMMVC6218E The maximum number of host I/O group pairs for the cluster is already configured.
- CMMVC6220E The maximum number of hosts for one or more I/O groups is already configured.
- CMMVC6224E The host already belongs to one or more of the I/O groups specified.
- CMMVC6252E The command failed authorization because the session SSH key is wrong or was deleted.
- CMMVC6253E The command failed authorization because the session SSH key does not have the requisite role.

An invocation example

```
svctask addhostiogrp -iogrpall testhost
```

The resulting output

No feedback

addhostport

The **addhostport** command adds worldwide port names (WWPNs) to an existing host object.

Syntax

```
svctask -- addhostport -- -hbawwpn -- wwpn_list -- [ -force ]
host_name | host_id
```

Parameters

-hbawwpn *wwpn_list*

(Required) Specifies the list of ports to add to the host.

-force

(Optional) Specifies that the list of ports be added to the host without the validation of any WWPNs.

host_id | host_name

(Required) Specifies the host object to add ports to, either by ID or by name.

Description

This command adds the list of HBA WWPNs to the specified host object. Only logged-in unconfigured WWPNs can be added. For a list of candidate WWPNs, see the **svcinfo lshbaportcandidate** command.

Some HBA device drivers do not log in to the fabric until they can see target LUNs. Because they do not log in, their WWPNs are not be recognized as candidate ports. You can specify the **-force** parameter with the **svctask addhostport** command to stop the validation of the WWPN list.

Any virtual disks that are mapped to this host object automatically map to the new ports.

Replacing an HBA in a host: List the candidate HBA ports by issuing the **svcinfo lshbaportcandidate** command. This command generates a list of the HBA ports that are available for addition to host objects. One or more of these ports should correspond with the one or more WWPNs that belong to the new HBA. Locate the host object that corresponds with the host in which you have replaced the HBA. The following command lists all the defined host objects:

```
svcinfo lshost
```

To list the WWPNs that are currently assigned to the host, issue the following command:

```
svcinfo lshost <hostobjectname>
```

where *<hostobjectname>* is the name of the host object.

Add the new ports to the existing host object by issuing the following command:

```
svctask addhostport -hbawwpn <one or more existing WWPNS  
separated by :> <hostobjectname/ID>
```

where *<one or more existing WWPNS separated by :>* and *<hostobjectname/id>* correspond with those listed in the previous steps.

Remove the old ports from the host object by issuing the following command:

```
svctask rmhostport -hbawwpn <one or more existing WWPNS  
separated by :> <hostobjectname/ID>
```

where *<one or more existing WWPNS separated by :>* corresponds with those that are listed in the previous step that belong to the old HBA that has been replaced. Any mappings that exist between the host object and VDisks are automatically applied to the new WWPNS. Therefore, the host should see the VDisks as the same SCSI LUNs as before. See the host multipathing device driver documentation for additional information about dynamic reconfiguration.

Possible failures

- CMMVC5786E The action failed because the cluster is not in a stable state.
- CMMVC5867E The action failed because the worldwide port name is already assigned or is not valid.
- CMMVC5872E The port (WWPN) was not added to the host object because an entity that was specified in the command does not exist.
- CMMVC5874E The action failed because the host does not exist.
- CMMVC5753E The object specified does not exist.
- CMMVC6252E The command failed authorization because the session SSH key is wrong or was deleted.
- CMMVC6253E The command failed authorization because the session SSH key does not have the requisite role.

An invocation example

```
svctask addhostport -hbawwpn 210100E08B251DD4 host_one
```

The resulting output

No feedback

chhost

The **chhost** command changes the name or type of a host object. This does not affect any current virtual disk-to-host mappings.

Syntax

```
▶▶ svctask — — chhost — —————▶  
└── -type ┌── hpx ───┐  
          ├── tpgs ───┐  
          └── generic ─┘
```

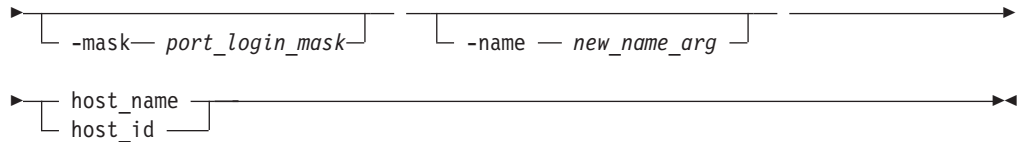

Parameters

-type *hpux | tpgs | generic*

(Optional) Specifies the type of host. Valid entries are *hpux*, *tpgs*, or *generic*. The default is *generic*.

-name *new_name_arg*

(Optional) Specifies the new name that you want to assign to the host object.

-mask *port_login_mask*

(Optional) Specifies which node target ports that a host can access. The port mask is four binary bits, and is made up of a combination of 0's or 1's. 0 indicates that the corresponding target port cannot be used, 1 indicates that it can be used. The right-most bit in the mask corresponds to the lowest numbered target port (1 not 4) on a node. Valid mask values range from 0000 (no ports enabled) to 1111 (all ports enabled). For example, a mask of 0011 enables port 1 and port 2. The default value is 1111 (that is, all ports are enabled).

host_name | host_id

(Required) Specifies the host object to modify, either by ID or by current name.

Description

This command can change the name of the specified host to a new name, or can change the type of host. This command does not affect any of the current virtual disk-to-host mappings.

The port mask applies to logins from the host initiator port that are associated with the host object. For each login between a host HBA port and node port, the node examines the port mask that is associated with the host object for which the host HBA is a member and determines if access is allowed or denied. If access is denied, the node responds to SCSI commands as if the HBA port is unknown.

Possible failures

- CMMVC5786E The action failed because the cluster is not in a stable state.
- CMMVC5868E The action failed because an entity that was specified in the command does not exist.
- CMMVC5869E The host object was not renamed because the host ID or name is not valid.
- CMMVC5874E The action failed because the host does not exist.
- CMMVC6252E The command failed authorization because the session SSH key is wrong or was deleted.
- CMMVC6253E The command failed authorization because the session SSH key does not have the requisite role.

An invocation example

```
svctask chhost -name testhostlode -mask 0011 hostone
```

The resulting output

mkhost

The **mkhost** command creates a logical host object.

Syntax

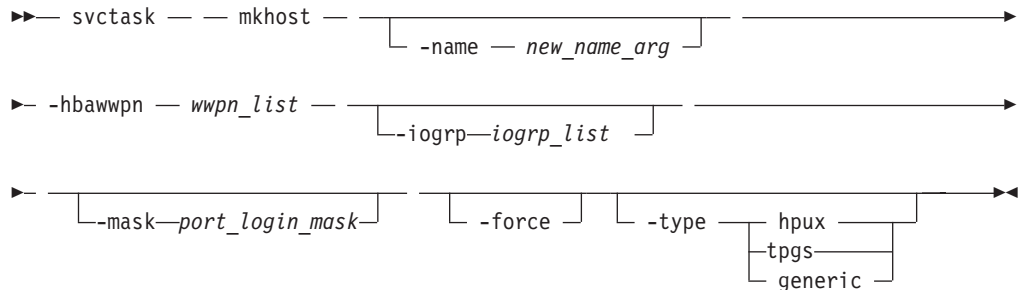

Parameters

-name *new_name_arg*

(Optional) Specifies a name or label for the new host object.

-hbawwpn *wwpn_list*

(Required) Specifies a list of host bus adapter (HBA) worldwide port names (WWPNs) to add to the specified host object.

-iogrp *iogrp_list*

(Optional) Specifies a set of one or more I/O groups that the host access the VDisks from. I/O groups are specified using their names or IDs, separated by a colon. Names and IDs can be mixed in the list. If this parameter is not specified, the host is associated with all I/O groups.

-mask *port_login_mask*

(Optional) Specifies which node target ports that a host can access. The port mask is four binary bits, and is made up of a combination of 0's or 1's. 0 indicates that the corresponding target port cannot be used, 1 indicates that it can be used. The right-most bit in the mask corresponds to the lowest numbered target port (1 not 4) on a node. Valid mask values range from 0000 (no ports enabled) to 1111 (all ports enabled). For example, a mask of 0011 enables port 1 and port 2. The default value is 1111 (that is, all ports are enabled).

-force

(Optional) Specifies that a logical host object be created without validation of the WWPNs.

-type *hpux | tpgs | generic*

(Optional) Specifies the type of host. Valid entries are *hpux*, *tpgs*, or *generic*. The default is *generic*.

Description

This command associates one or more HBA WWPNs with a logical host object. This command creates a new host. The ID is displayed when the command completes. You can subsequently use this object when mapping virtual disks to hosts by using the **mkvdiskhostmap** command.

You need to issue this command only once. The cluster scans the fabric for WWPNs in the host zone. The cluster itself cannot filter into the hosts to determine which WWPNs are in which hosts. Therefore, you must use the **svctask mkhost** command to identify the hosts.

After you identify the hosts, mappings are created between hosts and virtual disks. These mappings effectively present the virtual disks to the hosts to which they are mapped. All WWPNs in the host object are mapped to the virtual disks.

Some HBA device drivers do not log in to the fabric until they can see target logical unit numbers (LUNs). Because they do not log in, their WWPNs are not recognized as candidate ports. You can specify the **-force** parameter with this command to stop the validation of the WWPN list.

This command fails if you add the host to an I/O group that is associated with more host ports or host objects than is allowed by the limits within the cluster.

For additional information, see the **svctask mkvdiskhostmap** and **svcinfo lshbaportcandidate** commands.

Possible failures

- CMMVC5786E The action failed because the cluster is not in a stable state.
- CMMVC5867E The action failed because the worldwide port name is already assigned or is not valid.
- CMMVC5868E The action failed because an entity that was specified in the command does not exist.
- CMMVC5729E One or more components in the list is not valid.
- CMMVC6217E The maximum number of hosts for the cluster is already configured.
- CMMVC6218E The maximum number of host I/O group pairs for the cluster is already configured.
- CMMVC6219E The maximum number of WWPNs for the cluster is already configured.
- CMMVC6220E The maximum number of hosts for one or more I/O groups is already configured.
- CMMVC6221E The maximum number of WWPNs for one or more I/O groups is already configured.
- CMMVC6222E The maximum number of WWPNs for the host is already configured.
- CMMVC6252E The command failed authorization because the session SSH key is wrong or was deleted.
- CMMVC6253E The command failed authorization because the session SSH key does not have the requisite role.

An invocation example

```
svctask mkhost -name hostone -hbawwn 210100E08B251DD4 -force -mask 1001
```

The resulting output

```
Host id [1] successfully created.
```

rmhost

The **rmhost** command deletes a host object.

Syntax

```
svctask - - rmhost - [-force] - [host_name | host_id]
```

Parameters

-force

(Optional) Specifies that you want the system to delete the host object even if mappings still exist between this host and virtual disks (VDisks). When the **-force** parameter is specified, the mappings are deleted before the host object is deleted.

host_name | host_id

(Required) Specifies the host object to delete, either by ID or by name.

Description

The **rmhost** command deletes the logical host object. The WWPNs that were contained by this host object (if it is still connected and logged in to the fabric) are returned to the unconfigured state. When you issue the **svcinfo lshbaportcandidate** command, the host objects are listed as candidate ports.

If any mappings still exist between this host and virtual disks, the command fails unless you specify the **-force** parameter. When the **-force** parameter is specified, the **rmhost** command deletes the mappings before the host object is deleted.

Possible failures

- CMMVC5786E The action failed because the cluster is not in a stable state.
- CMMVC5870E The host object was not deleted because an entity that was specified in the command does not exist.
- CMMVC5871E The action failed because one or more of the configured worldwide port names is in a mapping.
- CMMVC5874E The action failed because the host does not exist.
- CMMVC5871E The host object was not deleted because there are virtual disk to host mappings for this host. To delete this host, a forced deletion is required.
- CMMVC6252E The command failed authorization because the session SSH key is wrong or was deleted.
- CMMVC6253E The command failed authorization because the session SSH key does not have the requisite role.

An invocation example

```
svctask rmhost host_one
```

The resulting output

```
No feedback
```

rmhostiogr

The **rmhostiogr** command enables you to delete mappings between one or more I/O groups and a specified host object.

Syntax

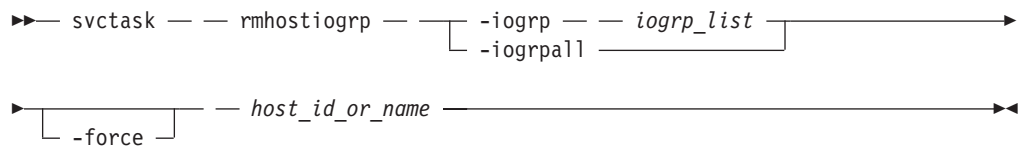

Parameters

-iogrps *iogrp_list*

(Required) Specifies a set of one or more I/O group mappings that will be deleted from the host. You cannot use this parameter with the **-iogrpsall** parameter.

-iogrpsall

(Optional) Specifies that all the I/O group mappings that are associated with the specified host must be deleted from the host. You cannot use this parameter with the **-iogrps** parameter.

-force

(Optional) Specifies that you want the system to remove the specified I/O group mappings on the host even if the removal of a host to I/O group mapping results in the loss of VDisk to host mappings.

host_id_or_name

(Required) Specifies the identity of the host either by ID or name from which the I/O group mappings must be deleted.

Description

The **rmhostiogrps** command deletes the mappings between the list of I/O groups and the specified host object.

This command fails if any of the I/O groups that are deleted from the host contain Vdisks that have host mappings to the host. To resolve this problem, do one of the following:

- Delete the Vdisk to host mappings that is causing the error.
- Delete the Vdisks or the host.
- Issue the **rmhostiogrps** command with the **-force** parameter.

Possible failures

- CMMVC5786E The action failed because the cluster is not in a stable state.
- CMMVC5874E The action failed because the host does not exist.
- CMMVC6223E The host does not belong to one or more of the I/O groups specified or inferred
- CMMVC6252E The command failed authorization because the session SSH key is wrong or was deleted.
- CMMVC6253E The command failed authorization because the session SSH key does not have the requisite role.

An invocation example

```
svctask rmhostiogrps -iogrps 1:2 host0
```

The resulting output

rmhostport

The **rmhostport** command deletes worldwide port names (WWPNs) from an existing host object.

Syntax

```

▶— svctask — — rmhostport — — -hbawwpn — wwpn_list — — [ -force ] — —▶
|
| host_name
| host_id
|
▶—————▶

```

Parameters

-hbawwpn *wwpn_list*

(Required) Specifies the list of ports that you can delete from the host.

-force

(Optional) Specifies that you want the system to delete the ports that you have specified without performing the validation check. The validation check ensures that the list of ports that you want to delete are actually mapped to the specified host. When the ports are deleted, they become unconfigured WWPNs.

host_name | host_id

(Required) Specifies the host name or the host ID.

Description

This command deletes the list of HBA WWPNs from the specified host object. If these ports are still logged in to the fabric, they become unconfigured and are listed as candidate WWPNs. See also the **svcinfo lshbaportcandidate** command.

Any virtual disks that are mapped to this host object are automatically unmapped from the ports.

Replacing an HBA in a host: List the candidate HBA ports by issuing the **svcinfo lshbaportcandidate** command. A list of the HBA ports that are available to be added to host objects is displayed. One or more of these ports corresponds with one or more WWPNs that belong to the new HBA. Locate the host object that corresponds with the host in which you have replaced the HBA. The following command lists all the defined host objects:

```
svcinfo lshost
```

To list the WWPNs that are currently assigned to the host, issue the following:

```
svcinfo lshost <hostobjectname>
```

where *<hostobjectname>* is the name of the host object.

Add the new ports to the existing host object by issuing the following command:

```
svctask addhostport -hbawwpn <one or more existing WWPNS  
separated by :> <hostobjectname/ID>
```

where <one or more existing WWPNS separated by :> and <hostobjectname/id> correspond with those listed in the previous steps.

Remove the old ports from the host object by issuing the following command:

```
svctask rmhostport -hbawwpn <one or more existing WWPNS  
separated by :> <hostobjectname/ID>
```

where <one or more existing WWPNS separated by :> corresponds with those WWPNS that are listed in the previous step that belong to the old HBA that has been replaced. Any mappings that exist between the host object and VDisks are automatically applied to the new WWPNS. Therefore, the host recognizes that the VDisks are the same SCSI LUNs as before. See the *Multipath Subsystem Device Driver: User's Guide* for additional information about dynamic reconfiguration.

Possible failures

- CMMVC5786E The action failed because the cluster is not in a stable state.
- CMMVC5867E The action failed because the worldwide port name is already assigned or is not valid.
- CMMVC5871E The action failed because one or more of the configured worldwide port names is in a mapping.
- CMMVC5872E The port (WWPN) was not added to the host object because an entity that was specified in the command does not exist.
- CMMVC5873E The action failed because there is no matching worldwide port name.
- CMMVC5874E The action failed because the host does not exist.
- CMMVC6252E The command failed authorization because the session SSH key is wrong or was deleted.
- CMMVC6253E The command failed authorization because the session SSH key does not have the requisite role.

An invocation example

```
svctask rmhostport -hbawwpn 210100E08B251DD4 host_one
```

The resulting output

No feedback

Chapter 11. Virtual disk commands

The following commands enable you to work with virtual disk options with the SAN Volume Controller.

chvdisk

The **chvdisk** command allows you to modify some of the properties (one property at a time) of a virtual disk including the name, the I/O group, the I/O governing rate, or the unit number (udid).

Syntax

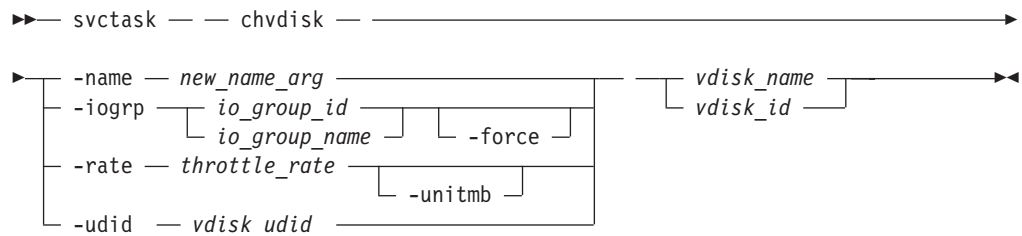

Parameters

-name *new_name_arg*

(Optional) Specifies a new name to assign to the virtual disk. You cannot use this parameter with the **-iogrp**, **-rate**, or **-udid** parameters.

Note: This parameter is required if you do not use the **-iogrp**, **-rate**, or **-udid** parameter.

-iogrp *io_group_id* | *io_group_name*

(Optional) Specifies a new I/O group to move the virtual disk to, either by ID or name. You can use the **-force** parameter with the **-iogrp** parameter to force the removal of the VDisk to the I/O group.

If the VDisk has a mapping to any hosts, it is not possible to move the VDisk to an I/O group that does not include any of those hosts.

You cannot use this parameter with the **-name**, **-rate**, or **-udid** parameters.

-force

(Optional) Specifies that you want to force the VDisk to be removed from an I/O group. This parameter can only be used with the **-iogrp** parameter.

Attention: The **-force** parameter can corrupt the contents of the VDisk. If the **-force** parameter is used and if the cluster is unable to destage all write data from the cache, the contents of the VDisk are corrupted by the loss of the cached data.

-rate *throttle_rate* [*-unitmb*]

(Optional) Specifies the I/O governing rate (essentially a cap on the amount of IO that will be accepted) for the virtual disk. The default units are I/Os, but they can be used in conjunction with the *-unitmb* argument to specify in terms of mega bytes per second.

You cannot use this parameter with the **-name**, **-iogrp**, or **-udid** parameters.

-udid *vdisk_udid*

(Optional) Specifies the udid for the disk. The udid is an identifier that is required to support OpenVMS hosts, no other systems use this parameter. Valid options are a decimal number from 0 to 32 767, or a hexadecimal number from 0 to 0x7FFF. A hexadecimal number must be preceded by '0x' (for example, 0x1234). If you do not use the **-udid** parameter, the default udid is 0.

You cannot use this parameter with the **-name**, **-iogrp**, or **-rate** parameters.

vdisk_name | **vdisk_id**

(Required) Specifies the virtual disk to modify, either by ID or by name.

Description

This command modifies a single property of a virtual disk. You can modify one property at a time. Therefore, to change the name and modify the I/O group, you must issue the command twice.

You can specify a new name or label. You can use the new name subsequently to refer to the virtual disk.

You can change the I/O group with which this virtual disk is associated. However, to change the I/O group, you must first flush the cache within the nodes in the current I/O group to ensure that all data is written to disk. Ensure that you suspend I/O operations at the host level before performing this operation.

Attention: Do not move a VDisk to an offline I/O group under any circumstance. You must ensure that the I/O group is online before moving the VDIsks to avoid any data loss.

You can set a limit on the amount of I/O transactions that is accepted for this virtual disk. It is set in terms of I/Os per second or MBs per second. By default, no I/O governing rate is set when a virtual disk is created.

Attention: All capacities, including changes must be in multiples of 512 bytes. An error occurs if you specify a capacity that is not a multiple of 512, which can only happen when byte units (-b) are used. However, an entire extent is reserved even if it is only partially used. The default capacity is in MB.

When the virtual disk is created, there is no throttling applied to it. Using the **-rate** parameter can change this. To change the virtual disk back to an unthrottled state, specify 0 (zero) with the **-rate** parameter.

You can migrate a VDisk to a new I/O group to manually balance the workload across the nodes in the cluster. You might end up with a pair of nodes that are overworked and another pair that are underworked. Use the following procedure to migrate a single VDisk to a new I/O group. Repeat for other VDIsks as required.

Attention: This is a disruptive procedure, access to the VDisk is lost while you follow this procedure.

Ensure that when you migrate a VDisk to a new I/O group, you quiesce all I/O operations for the VDisk. Determine the hosts that are using this VDisk. Stop or delete any FlashCopy mappings or Metro or Global Mirror relationships that use

this VDisk. To check if the VDisk is part of a relationship or mapping, issue the **svcinfo lsvdisk <vdiskname/id>** command, where <vdiskname/id> is the name or ID of the VDisk.

Look for the **FC_id** and **RC_id** fields. If these are not blank, the VDisk is part of a mapping or relationship. See “Managed disk commands” for details on how to stop or delete the mapping or relationship. Issue the following command to migrate the VDisk:

```
svctask chvdisk -iogrp <newiogrpname/id> <vdiskname/id>
```

Follow the procedure to discover the new vpaths and to check that each vpath is presenting the correct number of paths. See the *Multipath Subsystem Device Driver: User's Guide* for details on how to dynamically reconfigure SDD for the given host operating system.

Possible failures

- CMMVC5756E Cannot perform the request as the object is already mapped.
- CMMVC5786E The action failed because the cluster is not in a stable state.
- CMMVC5832E The property of the virtual disk (VDisk) was not modified because an entity that was specified in the command does not exist.
- CMMVC5833E The property of the virtual disk (VDisk) was not modified because there are no nodes in the I/O group.
- CMMVC5834E The I/O group for the virtual disk (VDisk) was not modified because the group is a recovery I/O group. To modify the I/O group, use the force option.
- CMMVC5848E The action failed because the virtual disk (VDisk) does not exist or it is being deleted.
- CMMVC5853E The action failed because there was a problem with the group.
- CMMVC5856E The action failed because the virtual disk (VDisk) does not belong to the specified managed disk (MDisk) group.
- CMMVC5857E The action failed because the managed disk (MDisk) does not exist or it is not a member of the managed disk (MDisk) group.
- CMMVC5858E The action failed because the virtual disk (VDisk) is in the wrong mode, the managed disk (MDisk) is in the wrong mode, or both are in the wrong mode.
- CMMVC5860E The action failed because there were not enough extents in the managed disk (MDisk) group.
- CMMVC5861E The action failed because there were not enough extents on the managed disk (MDisk).
- CMMVC5862E The action failed because the virtual disk (VDisk) is being formatted.
- CMMVC6076E The VDisk cache is not empty. Wait for the cache to flush or use the force flag to discard contents of the cache.
- CMMVC6032E The operation was not performed because one or more of the entered parameters is invalid for this operation.
- CMMVC6223E The host does not belong to one or more of the I/O groups specified or inferred.
- CMMVC6252E The command failed authorization because the session SSH key is wrong or was deleted.

- CMMVC6253E The command failed authorization because the session SSH key does not have the requisite role.

An invocation example

```
svctask chvdisk -rate 2040 -unitmb 6
```

The resulting output

No feedback

expandvdisksize

The **expandvdisksize** command expands the size of a VDisk by a given capacity.

Syntax

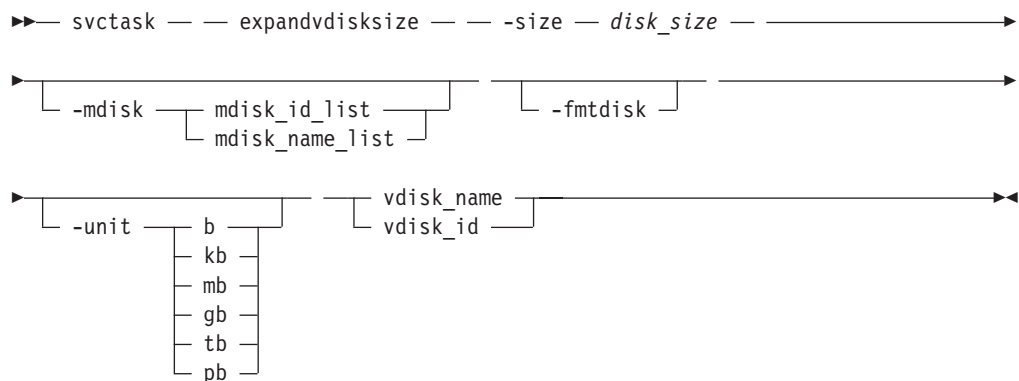

Parameters

-size *disk_size*

(Required) Specifies the capacity by which the virtual disk is expanded. Disk size is used in conjunction with the value of the unit. All capacities, including changes must be in multiples of 512 bytes. An error occurs if you specify a capacity that is not a multiple of 512, which can only happen when byte units (-b) are used. However, an entire extent is reserved even if it is only partially used. The default capacity is in MB.

-mdisk *mdisk_id_list* | *mdisk_name_list*

(Optional) Specifies the list of one or more MDisks to be used as the stripe set. The extents that expand the VDisk come from the specified list of MDisks. All MDisks in the list must be part of the same MDisk group.

-fmtdisk

(Optional) Specifies that the VDisk be formatted before use. This parameter formats (all zeros) the new extents that have been added to the VDisk as a result of the **expandvdisksize** command. The **expandvdisksize** command completes asynchronously if you use this parameter.

-unit *b* | *kb* | *mb* | *gb* | *tb* | *pb*

(Optional) Specifies the data units that are used in conjunction with the capacity (-size).

vdisk_name | **vdisk_id**

(Required) Specifies the virtual disk to modify, either by ID or by name.

Description

This command expands the capacity that is allocated to the particular virtual disk by the given amount. The default capacity is in MB.

When a VDisk is expanded, the virtualization policy can change. Its mode becomes striped even if it was previously sequential. See the `svctask mkvdisk` command for details of the virtualization policies.

Possible failures

- CMMVC5756E Cannot perform the request as the object is already mapped to another object or is the subject of an FC or RC relationship.
- CMMVC5786E The action failed because the cluster is not in a stable state.
- CMMVC5808E The action failed because the managed disk (MDisk) does not exist.
- CMMVC5835E The virtual disk (VDisk) was not expanded because an object that was specified in the command does not exist.
- CMMVC5837E The action failed because the virtual disk (VDisk) is part of a FlashCopy mapping.
- CMMVC5838E The action failed because the virtual disk (VDisk) is part of a Remote Copy mapping.
- CMMVC5848E The action failed because the virtual disk (VDisk) does not exist or it is being deleted.
- CMMVC5853E The action failed because there was a problem with the group.
- CMMVC5856E The action failed because the virtual disk (VDisk) does not belong to the specified managed disk (MDisk) group.
- CMMVC5857E The action failed because the managed disk (MDisk) does not exist or it is not a member of the managed disk (MDisk) group.
- CMMVC5858E The action failed because the virtual disk (VDisk) is in the wrong mode, the managed disk (MDisk) is in the wrong mode, or both are in the wrong mode.
- CMMVC5860E The action failed because there were not enough extents in the managed disk (MDisk) group.
- CMMVC5861E The action failed because there were not enough extents on the managed disk (MDisk).
- CMMVC5862E The action failed because the virtual disk (VDisk) is being formatted.
- CMMVC5998W The virtualized storage capacity exceeds the amount that you are licensed to use.
- CMMVC6036E An invalid action was requested
- CMMVC6252E The command failed authorization because the session SSH key is wrong or was deleted.
- CMMVC6253E The command failed authorization because the session SSH key does not have the requisite role.

An invocation example

```
svctask expandvdisksize -size 2048 -unit b -mdisk  
mdisk0:mdisk1 -fmt disk vdisk1
```

The resulting output

No feedback

mkvdisk

The **mkvdisk** command creates sequential, striped, or image mode virtual disk objects. When they are mapped to a host object, these objects are seen as disk drives with which the host can perform I/O operations.

Note: The first syntax diagram depicts the creation of a sequential or striped mode virtual disk. The second syntax diagram depicts the creation of an image mode virtual disk.

Syntax

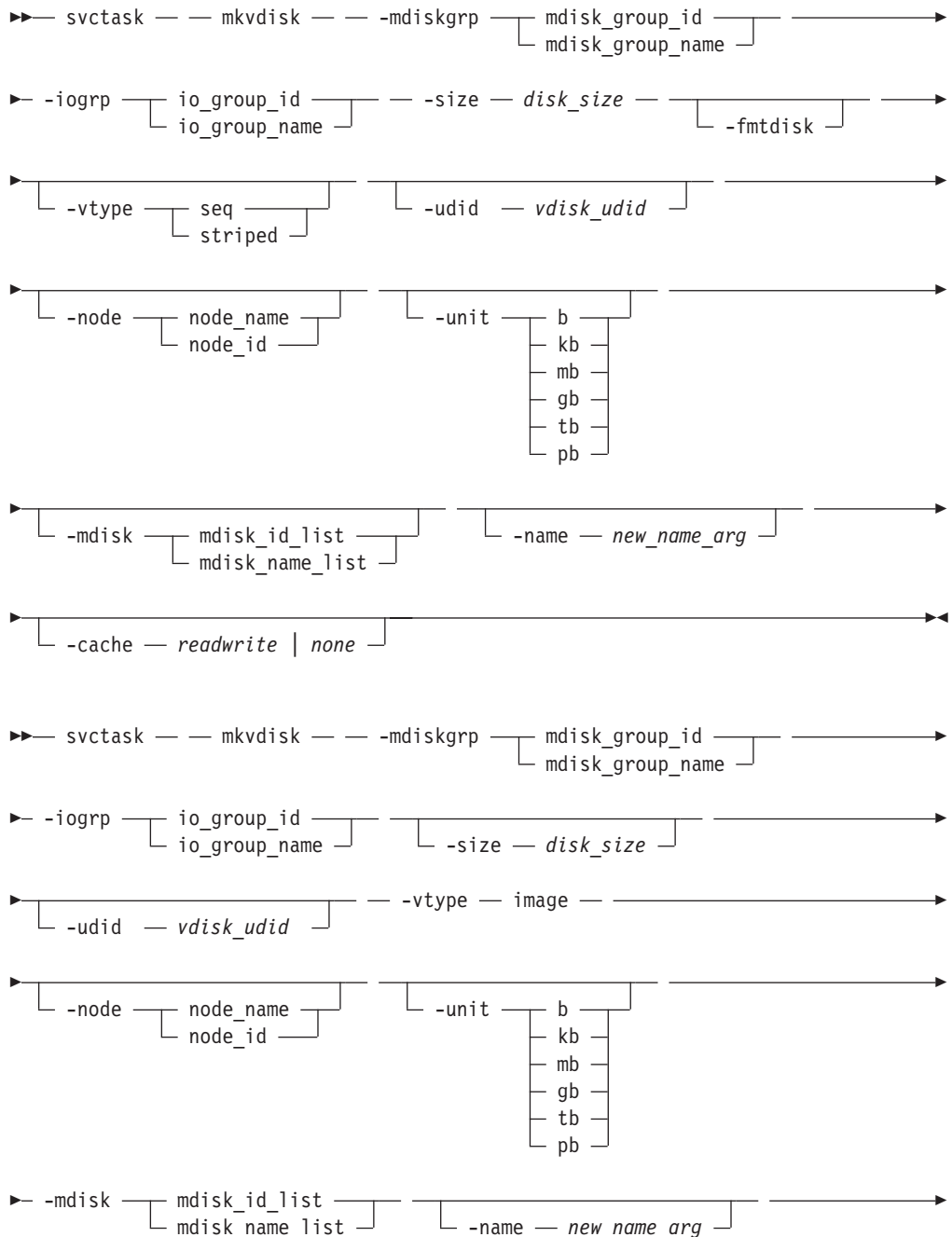

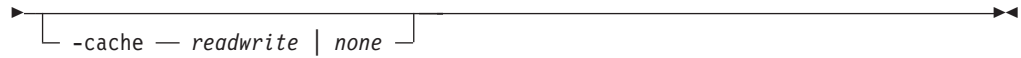

Parameters

-mdiskgrp *mdisk_group_id* | *mdisk_group_name*

(Required) Specifies the managed disk group to use when you are creating this virtual disk.

-iogrp *io_group_id* | *io_group_name*

(Required) Specifies the I/O group (node pair) with which to associate this virtual disk.

-udid *vdisk_udid*

(Optional) Specifies the udid for the disk. The udid is an identifier that is required to support OpenVMS hosts, no other systems use this parameter. Valid options are a decimal number from 0 to 32 767, or a hexadecimal number from 0 to 0x7FFF. A hexadecimal number must be preceded by '0x' (for example, 0x1234). If you do not use the **-udid** parameter, the default udid is 0.

-size *disk_size*

(Required for sequential or striped VDisk creation; Optional for image VDisk creation) Specifies the capacity of the virtual disk, which is used in conjunction with the unit's value. All capacities, including changes, must be in multiples of 512 bytes. An error occurs if you specify a capacity that is not a multiple of 512, which can only happen when byte units (-b) are used. However, an entire extent is reserved even if it is only partially used. The default capacity is in MB. You can specify a capacity of 0. Specify the size in bytes in multiples of logical block address (LBA) sizes.

Note: If you do not specify the **-size** parameter when you create an image mode disk, the entire MDisk capacity is used.

-fmtdisk

(Optional; does not apply when you create an image mode VDisk) Specifies that the virtual disk be formatted before it can be used. The **-fmtdisk** parameter formats (sets to all zeros) the extents that make up this VDisk after it is created. If this parameter is used, the command completes asynchronously and you can query the status with the **svcinfolsvdiskprogress** command.

-vtype *seq* | *striped* | *image*

(Optional for sequential or striped VDisk creation; Required for image VDisk creation) Specifies the virtualization policy. The default virtualization type is striped when you are creating a nonimage VDisk. Refer to the notes below for more information.

-node *node_id* | *node_name*

(Optional) Specifies the preferred node ID or the name for I/O operations to this virtual disk. You can use the **-node** parameter to specify the preferred access node.

Note: This parameter is required for the subsystem device driver (SDD) and the cluster chooses a default if you do not supply this parameter.

-unit *b* | *kb* | *mb* | *gb* | *tb* | *pb*

(Optional) Specifies the data units to use in conjunction with the capacity that is specified by the **-size** parameter.

-mdisk *mdisk_id_list* | *mdisk_name_list*

(Optional for sequential or striped VDisk creation; Required for image VDisk

creation) Specifies a list of one or more managed disks. This parameter is used in conjunction with the **-vtype** parameter and has different uses depending upon the policy that you chose. The following notes within the Description section provide additional information.

-name *new_name_arg*

(Optional) Specifies a name to assign to the new virtual disk.

-cache *readwrite | none*

(Optional) Specifies the caching options for the VDisk. Valid entries are *readwrite* or *none*. The default is *readwrite*. If you do not specify the **-cache** parameter, the default value (*readwrite*) is used.

Description

This command creates a new virtual disk object. You can use the command to create a variety of types of virtual disk objects and, as such, it is one of the most complex commands.

You must decide which managed disk group provides the storage for the VDisk. Use the **svcinfolsmdiskgrp** command to list the available managed disk groups and the amount of free storage in each group.

Decide which I/O group that the VDisk should be assigned to. This determines which nodes in the cluster process the I/O requests from the host systems. If you have more than one I/O group, ensure that you distribute the VDIsks between the I/O groups so that the I/O workload is shared evenly between all nodes. Use the **svcinfolsiogrp** command to show the I/O groups and the number of virtual disks that are assigned to each I/O group.

Note: It is normal for clusters with more than one I/O group to have MDisk groups that have VDIsks in different I/O groups. FlashCopy processing can make copies of VDIsks regardless of whether the source and destination VDIsks are in the same I/O group. If, however, you plan to use intracluster Metro or Global Mirror operations, ensure that both the master and auxiliary VDisk are in the same I/O group.

The virtualization policy controls the type of virtual disk to create. These policies include striped and seq(uential) and image:

Striped

This is the default policy. If the **-vtype** parameter is not specified, this policy is used in its default form. That is, all managed disks in the managed disk group are used to create the virtual disk. The striping is at an extent level, in a circular fashion, one extent from each managed disk in the group is used. For example, a managed disk group with 10 managed disks uses one extent from each managed disk, then it uses the 11th extent from the first managed disk, and so on.

If the **-mdisk** parameter is also specified, you can supply a list of managed disks to use as the stripe set. This can be two or more managed disks from the same managed disk group. The same circular algorithm is used across the striped set. However, a single managed disk can be specified more than once in the list. For example, if you enter **-m 0:1:2:1**, the extents are from the following maintenance disks: 0, 1, 2, 1, 0, 1, 2, and so forth. All MDIsks specified in the **-mdisk** parameter must be in the managed mode.

A capacity of 0 is allowed.

Seq (Sequential)

This policy requires the **-mdisk** parameter with a single managed disk as its argument. This MDisk must be in the managed mode.

It creates the virtual disk using extents from the given managed disk (assuming there are enough free extents on the managed disk).

Image Image mode virtual disks can be created when a managed disk already has data on it, perhaps from a previrtualized subsystem. When an image mode virtual disk is created, it directly corresponds to the (previously unmanaged) managed disk that it was created from; therefore, virtual disk logical block address (LBA) x equals managed disk LBA x . You can use this command to bring a nonvirtualized disk under the control of the cluster. After it is under the control of the cluster, you can migrate the virtual disk from the single managed disk. When it is migrated, the virtual disk is no longer an image mode virtual disk.

You can add image mode VDIs to an already populated MDisk group with other types of VDIs, such as a striped or sequential.

Note: An image mode VDisk must be at least 512 bytes (capacity cannot be 0). That is, the minimum size that can be specified for an image mode VDisk must be the same as the MDisk group extent size that it is added to, with the minimum being 16 Mb.

You must use the **-mdisk** parameter to specify an MDisk that has a mode of unmanaged. The **-fmtmdisk** parameter cannot be used to create an image mode VDisk.

The command returns the IDs of the newly created VDisk.

Attention:

1. Do not create a VDisk in an offline I/O group. You must ensure that the I/O group is online before you create a VDisk to avoid any data loss. This applies in particular to recreating VDIs that are assigned the same object ID.
2. To create an image mode disk, you must already have a quorum disk in the cluster because an image mode disk cannot be used to hold quorum data. See “Creating a quorum disk” in the *IBM System Storage SAN Volume Controller: Software Installation and Configuration Guide* for more details.

Possible failures

Note: If you receive an error for this command that indicates that the licensed virtualization capacity has been exceeded, then the command was still effective. However, the return code will indicate the license violation.

- CMMVC5786E The action failed because the cluster is not in a stable state.
- CMMVC5807E The action failed because the managed disk (MDisk) cannot be changed to the specified mode.
- CMMVC5808E The action failed because the managed disk (MDisk) does not exist.
- CMMVC5826E The virtual disk (VDisk) was not created because an entity that was specified in the command does not exist.
- CMMVC5827E The command failed as a result of an inconsistency between two or more of the entered parameters.

- CMMVC5828E The virtual disk (VDisk) was not created because the I/O group contains no nodes.
- CMMVC5829E The image-mode virtual disk (VDisk) was not created because the number of managed disks (MDisks) specified is greater than one.
- CMMVC5830E The image-mode virtual disk (VDisk) was not created because no managed disk (MDisk) was specified in the command.
- CMMVC5831E The virtual disk (VDisk) was not created because the preferred node for I/O operations is not part of the I/O group.
- CMMVC5857E The action failed because the managed disk (MDisk) does not exist or it is not a member of the managed disk (MDisk) group.
- CMMVC5858E The action failed because the virtual disk (VDisk) is in the wrong mode, the managed disk (MDisk) is in the wrong mode, or both are in the wrong mode.
- CMMVC5860E The action failed because there were not enough extents in the managed disk (MDisk) group.

Note: This error is also returned if a stripe set of MDisks has been specified and one or more of these MDisks does not contain enough free extents to complete the creation of the VDisk. In this case, the MDisk group will be reporting that it has enough free capacity to create the VDisk. You can check the free capacity on each MDisk by issuing the **svcinfo lsfreeextents <mdiskname/ID>** command. Alternatively, do not specify a stripe set and let the system choose the free extents automatically.

- CMMVC5861E The action failed because there were not enough extents on the managed disk (MDisk).
- CMMVC6226E (Possible for image creation only) The action was not completed because the cluster has reached the maximum number of extents in MDisk Groups.
- CMMVC6252E The command failed authorization because the session SSH key is wrong or was deleted.
- CMMVC6253E The command failed authorization because the session SSH key does not have the requisite role.
-

An invocation example

```
svctask mkvdisk -mdiskgrp Group0 -size 0
-iogrp 0 -vtype striped -mdisk mdisk1 -node 1
```

The resulting output

```
Virtual Disk, id [1], successfully created
```

An invocation example for creating an image mode VDisk

```
svctask mkvdisk -mdiskgrp Group0
-iogrp 0 -vtype image -mdisk mdisk2 -node 1
```

The resulting output

```
Virtual Disk, id [2], successfully created
```

mkvdiskhostmap

The **mkvdiskhostmap** command creates a new mapping between a virtual disk and a host. That is, the virtual disk is now accessible for I/O operations to the specified host.

Syntax

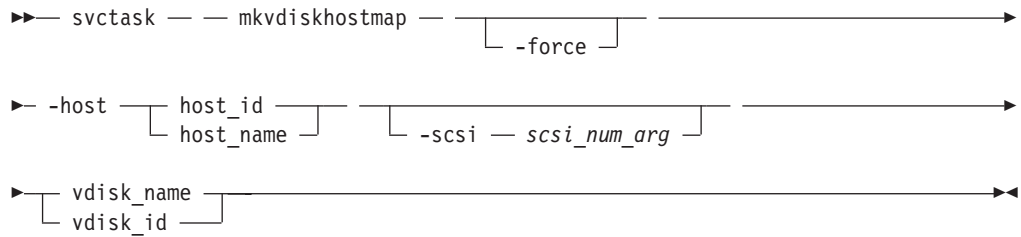

Parameters

-force

(Optional) Specifies that you want the system to allow multiple VDisk-to-host assignments, which are not normally allowed.

-host *host_id* | *host_name*

(Required) Specifies the host that you want to map the virtual disk to, either by ID or by name.

-scsi *scsi_num_arg*

(Optional) Specifies the SCSI LUN ID to assign to this virtual disk on the given host. The *scsi_num_arg* parameter contains the SCSI LUN ID that is assigned to the VDisk on the given host. You must check your host system for the next available SCSI LUN ID on the given HBA. If you do not specify the **-scsi** parameter, the next available SCSI LUN ID is provided to the host.

vdisk_name | **vdisk_id**

(Required) Specifies the name of the virtual disk that you want to map to the host, either by ID or by name.

Description

This command creates a new mapping between the virtual disk and the specified host. The virtual disk is presented to the host as if the disk is directly attached to the host. It is only after this command is processed, that the host can perform I/O transactions to the virtual disk.

Optionally, you can assign a SCSI LUN ID to the mapping. When the HBA in the host scans for devices that are attached to it, it discovers all virtual disks that are mapped to its fibre-channel ports. When the devices are found, each one is allocated an identifier (SCSI LUN ID). For example, the first disk found is usually SCSI LUN 1, and so on. You can control the order in which the HBA discovers virtual disks by assigning the SCSI LUN ID, as required. If you do not specify a SCSI LUN ID, the cluster automatically assigns the next available SCSI LUN ID, given any mappings that already exist with that host.

Some HBA device drivers will stop when they find a gap in the SCSI LUN IDs. For example:

- Virtual Disk 1 is mapped to Host 1 with SCSI LUN ID 1
- Virtual Disk 2 is mapped to Host 1 with SCSI LUN ID 2
- Virtual Disk 3 is mapped to Host 1 with SCSI LUN ID 4

When the device driver scans the HBA, it must stop after identifying virtual disks 1 and 2, because there is no SCSI LUN that is mapped with ID 3. For optimal performance, ensure that the SCSI LUN ID allocation is contiguous.

You can create multiple VDisk assignments. Normally, multiple VDisk-to-host assignments are not used because corruption is likely to occur if more than one host can access a disk. However, in *certain* multiple path environments, such as that found in the IBM SAN File System, a VDisk **must** be mapped to more than one host. To map to more than one host, you must use the **mkvdiskhostmap** command with the **-force** parameter. For example:

```
svctask mkvdiskhostmap -host host1 -force 4
```

```
svctask mkvdiskhostmap -host host2 -force 4
```

The above commands create two host-to-VDisk mappings for VDisk 4 that map to host1 and host2. Note that omitting the **-force** parameter causes the mapping to fail if that VDisk is already mapped to a host.

The command fails if the host object (to which this mapping is being made) is not associated with the I/O group containing the VDisk.

Possible failures

- CMMVC5786E The action failed because the cluster is not in a stable state.
- CMMVC5842E The action failed because an entity that was specified in the command does not exist.
- CMMVC5843E The virtual disk (VDisk)-to-host mapping was not created because the VDisk does not have a capacity greater than zero bytes.
- CMMVC5844E The virtual disk (VDisk)-to-host mapping was not created because the SCSI logical unit number (LUN) ID is not valid.
- CMMVC5862E The action failed because the virtual disk (VDisk) is being formatted.
- CMMVC5874E The action failed because the host does not exist.
- CMMVC5875E The action failed because the virtual disk (VDisk) does not exist.
- CMMVC5876E The virtual disk (VDisk)-to-host mapping was not created because the maximum number of mappings has been reached.
- CMMVC5877E The virtual disk (VDisk)-to-host mapping was not created because the maximum number of SCSI LUNs has been allocated.
- CMMVC5878E The virtual disk (VDisk)-to-host mapping was not created because this VDisk is already mapped to this host.
- CMMVC5879E The virtual disk (VDisk)-to-host mapping was not created because this VDisk is already mapped to this host with this SCSI LUN.
- CMMVC5880E The virtual disk (VDisk)-to-host mapping was not created because the VDisk has a capacity of zero bytes.
- CMMVC6071E This action will result in the creation of multiple mappings. Use the **-force** flag if you are sure that this is what you wish to do.
- CMMVC6252E The command failed authorization because the session SSH key is wrong or was deleted.
- CMMVC6253E The command failed authorization because the session SSH key does not have the requisite role.

An invocation example

```
svctask mkvdiskhostmap -host host1 -scsi 1 5
```

The resulting output

```
Virtual Disk to Host map, id [1], successfully created
```

rmvdisk

The **rmvdisk** command deletes a virtual disk (VDisk). The command fails if there are mappings between the virtual disk and hosts and if you do not specify the **-force** parameter.

Syntax

```
svctask -- rmvdisk [-force] vdisk_id | vdisk_name
```

Parameters

-force

(Optional) Specifies that you want the system to delete the VDisk even if mappings still exist between this virtual disk and hosts. This parameter deletes any host-to-VDisk mappings and any FlashCopy mappings that exist for this VDisk. Data that was on the virtual disk is lost. Before you issue this command, ensure that the virtual disk (and any data that resides on it) is no longer required.

vdisk_id | vdisk_name

Specifies the name of the virtual disk to delete, either by ID or by name.

Description

This command deletes an existing managed mode virtual disk or an existing image mode virtual disk. The extents that made up this virtual disk are returned to the pool of free extents that are available on the managed disk group, if the VDisk is in managed mode.

Attention: Any data that was on the virtual disk is lost. Before you issue this command, ensure that the virtual disk (and any data that resides on it) is no longer required.

Deleting a managed mode virtual disk

When you use this command to delete a managed mode virtual disk, all the data on the virtual disk is deleted. The extents that make up the virtual disk are returned to the pool of free extents that are available in the managed disk group.

If FlashCopy mappings or host mappings exist for the virtual disk, the deletion fails. You can use the **-force** parameter to force the deletion. If you use the **-force** parameter, mappings are deleted, and then the virtual disk is deleted.

If the virtual disk is in the process of migrating to an image mode virtual disk (using the **svctask migratetoimage** command), the deletion fails unless you use the **-force** parameter. If you use the **-force** parameter, the migration is halted and then the virtual disk is deleted. Before you issue this command, ensure that the virtual disk (and any data that resides on it) is no longer required.

Deleting an image mode virtual disk

When you use this command to delete an image mode virtual disk, the data on the controller logical unit is consistent with the data that had been available on the image mode virtual disk before it was deleted. In other words, the fast write data

is moved to the controller logical unit. If the **-force** parameter is used, then the data is not moved to the controller logical unit.

If there are any virtual medium errors on the virtual disk, the command fails. You can force the deletion by using the **-force** parameter; however, this can cause data integrity issues.

Note: A virtual medium error occurs when you copy data from one disk (the source) to another (the target). If you read the source, you should detect that there is a medium error. At that moment you have to have two identical copies of data and you then have to simulate a medium error on the target disk. You can simulate that medium error on the target disk by creating a virtual medium error on the target disk.

If FlashCopy mappings or host mappings exist for the virtual disk, the deletion fails unless you use the **-force** parameter. If you use the **-force** parameter, mappings are deleted, and the virtual disk is deleted. If there is any data that is not staged in the fast write cache for this virtual disk, the deletion of the virtual disk fails. When the **-force** parameter is specified, any data that is not staged in the fast write cache is deleted. Deleting an image mode virtual disk causes the managed disk that is associated with the virtual disk to be removed from the managed disk group. The mode of the managed disk is returned to “unmanaged.”

Possible failures

- CMMVC5786E The action failed because the cluster is not in a stable state.
- CMMVC5807E The action failed because the managed disk (MDisk) cannot be changed to the specified mode.
- CMMVC5840E The virtual disk (VDisk) was not deleted because it is mapped to a host or because it is part of a Remote Copy mapping.
- CMMVC5841E The virtual disk (VDisk) was not deleted because it does not exist.
- CMMVC5848E The action failed because the virtual disk (VDisk) does not exist or it is being deleted.
- CMMVC5858E The action failed because the virtual disk (VDisk) is in the wrong mode, the managed disk (MDisk) is in the wrong mode, or both are in the wrong mode.
- CMMVC5862E The action failed because the virtual disk (VDisk) is being formatted.
- CMMVC6252E The command failed authorization because the session SSH key is wrong or was deleted.
- CMMVC6253E The command failed authorization because the session SSH key does not have the requisite role.

An invocation example

```
svctask rmvdisk -force vdisk5
```

The resulting output

```
No feedback
```

rmvdiskhostmap

The **rmvdiskhostmap** command deletes an existing virtual disk-to-host mapping. That is, the virtual disk is no longer accessible for I/O transactions on the given host.

Syntax

```
svctask -- rmvdiskhostmap -- -host [ host_id | host_name ]
[ vdisk_id | vdisk_name ]
```

Parameters

-host *host_id* | *host_name*

(Required) Specifies the host that you want to remove from the map with the virtual disk, either by ID or by name.

vdisk_id | **vdisk_name**

(Required) Specifies the name of the virtual disk that you want to remove from the host mapping, either by ID or by name.

Description

This command deletes an existing mapping between the specified virtual disk and the host. This effectively stops the virtual disk from being available for I/O transactions on the given host.

This command also deletes a SCSI or persistent reservation that a host has on a VDisk. Once the reservation is removed, a new host is allowed to access the VDisk in the future because the original host no longer has access.

Care should be taken when processing this command because to the host it seems as if the virtual disk has been deleted or is offline.

Possible failures

- CMMVC5786E The action failed because the cluster is not in a stable state.
- CMMVC5842E The action failed because an entity that was specified in the command does not exist.
- CMMVC5874E The action failed because the host does not exist.
- CMMVC5875E The action failed because the virtual disk (VDisk) does not exist.
- CMMVC6252E The command failed authorization because the session SSH key is wrong or was deleted.
- CMMVC6253E The command failed authorization because the session SSH key does not have the requisite role.

An invocation example

```
svctask rmvdiskhostmap -host host1 vdisk8
```

The resulting output

```
No feedback
```

shrinkvdisksize

The **shrinkvdisksize** command allows you to shrink a VDisk by a given capacity.

Syntax

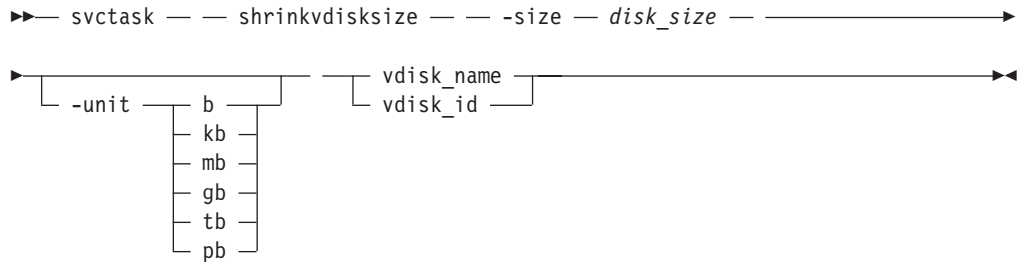

Parameters

-size *disk_size*

(Required) Specifies the size reduction for the designated virtual disk.

-unit *b | kb | mb | gb | tb | pb*

(Optional) Specifies the data units to be used in conjunction with the value specified by the **-size** parameter.

vdisk_name | vdisk_id

(Required) Specifies the virtual disk that you want to modify, either by ID or by name.

Description

This command reduces the capacity that is allocated to the particular virtual disk by the given amount. All capacities, including changes must be in multiples of 512 bytes. An error occurs if you specify a capacity that is not a multiple of 512, which can only happen when byte units (-b) are used. However, an entire extent is reserved even if it is only partially used. The default capacity is in MB.

VDisks can be reduced in size should it be required. However, if the VDisk contains data that is being used, **under no circumstances should you attempt to shrink a VDisk without first backing up your data**. The cluster arbitrarily reduces the capacity of the VDisk by removing a partial, one or more extents from those allocated to the VDisk. You cannot control which extents are removed and so you cannot assume that it is unused space that is removed.

Attention:

1. This feature should *only* be used to make a target or auxiliary VDisk the same size as the source or master VDisk when you create FlashCopy mappings or Metro or Global Mirror relationships. You must also ensure that the target VDisk is not mapped to any hosts prior to performing this operation.
2. If the virtual disk contains data, you should not shrink the disk.
3. Some operating systems or file systems use what they consider to be the outer edge of the disk for performance reasons. This command is provided to shrink FlashCopy target virtual disks to the same capacity as the source.
4. Validate that the VDisk is not mapped to any host objects. If the VDisk is mapped, data is displayed. You can determine the exact capacity of the source or master VDisk by issuing the `svcinfo lsvdisk -bytes <vdiskname>` command. Shrink the VDisk by the required amount by issuing the `svctask shrinkvdisksize -size <capacitytoshrinkby> -unit <unitsforreduction> <vdiskname/ID>` command.

Possible failures

- CMMVC5786E The action failed because the cluster is not in a stable state.
- CMMVC5836E The virtual disk (VDisk) was not shrunk because it is locked.
- CMMVC5837E The action failed because the virtual disk (VDisk) is part of a FlashCopy mapping.
- CMMVC5838E The action failed because the virtual disk (VDisk) is part of a Remote Copy mapping.
- CMMVC5839E The virtual disk (VDisk) was not shrunk because an entity that was specified in the command does not exist.
- CMMVC5848E The action failed because the virtual disk (VDisk) does not exist or it is being deleted.
- CMMVC5862E The action failed because the virtual disk (VDisk) is being formatted.
- CMMVC6010E Unable to complete the command as there are insufficient free extents.
- CMMVC6252E The command failed authorization because the session SSH key is wrong or was deleted.
- CMMVC6253E The command failed authorization because the session SSH key does not have the requisite role.

An invocation example

```
svctask shrinkvdisksize -size 2048 -unit b vdisk1
```

The resulting output

No feedback

Chapter 12. Managed disk group commands

The following commands enable you to work with managed disk group options with the SAN Volume Controller.

addmdisk

You can use the **addmdisk** command to add one or more managed disks to an existing managed disk group.

Syntax

```
svctask -- addmdisk -- -mdisk [mdisk_id_list | mdisk_name_list]
[mdisk_group_id | mdisk_group_name]
```

Parameters

-mdisk *mdisk_id_list* | *mdisk_name_list*

Specifies one or more managed disk IDs or names to add to the group.

mdisk_group_id | **mdisk_group_name**

Specifies the ID or name of the managed disk group to add the disks to.

Description

This command adds the managed disks that you specify to the group. The disks can be specified in terms of managed disk ID or managed disk name.

The managed disks must be in unmanaged mode. Disks that already belong to a group cannot be added to another group until they have been deleted from their current group. You can delete a managed disk from a group under the following circumstances:

- If the managed disk does not contain any extents in use by a virtual disk
- If you can first migrate the extents in use onto other free extents within the group.

Possible failures

- CMMVC5786E The action failed because the cluster is not in a stable state.
- CMMVC5819E The managed disk (MDisk) was not added to the MDisk group because the MDisk is part of another MDisk group.
- CMMVC5820E The managed disk (MDisk) was not added to the MDisk group because an entity that was specified in the command does not exist.
- CMMVC5821E The managed disk (MDisk) was not added to the MDisk group because not enough MDisks were included in the list.
- CMMVC5822E The managed disk (MDisk) was not added to the MDisk group because too many MDisks were included in the list.
- CMMVC5807E The action failed because the managed disk (MDisk) cannot be changed to the specified mode.

- CMMVC5808E The action failed because the managed disk (MDisk) does not exist.

An invocation example

```
svctask addmdisk -mdisk mdisk13:mdisk14 Group0
```

The resulting output

No feedback

chmdiskgrp

Use the **chmdiskgrp** command to modify the name, or label, assigned to a managed disk group.

Syntax

```
svctask -- chmdiskgrp -- -name -- new_name_arg --  
├── mdisk_group_id ───┐  
└── mdisk_group_name ─┘
```

Parameters

-name *new_name_arg*

Specifies the new name of the managed disk group.

mdisk_group_id | mdisk_group_name

Specifies the ID or name of the managed disk group to modify.

Description

This command modifies the name, or label, assigned to a given managed disk group. Subsequently, you can use the new name to refer to the managed disk group.

Possible failures

- CMMVC5786E The action failed because the cluster is not in a stable state.
- CMMVC5816E The action failed because an entity that was specified in the command does not exist.
- CMMVC5817E The managed disk (MDisk) group was not renamed because the name was not valid.

An invocation example

```
svctask chmdiskgrp -name testmdiskgrp Group0
```

The resulting output

No feedback

mkmdiskgrp

You can use the **mkmdiskgrp** command to create a new managed disk group. Managed disk groups are collections of managed disks. Each group is divided into chunks, called extents. These extents are then used to create virtual disks.

Syntax

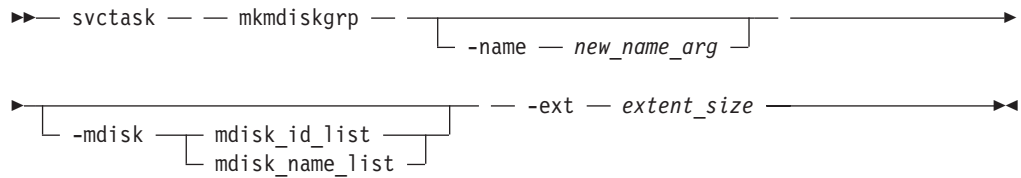

Parameters

-name *new_name_arg*

Optionally specifies a name to assign to the new group.

-mdisk *mdisk_id_list* | *mdisk_name_list*

Optionally specifies the name of the managed disk IDs or names to add to the group. You can create an empty MDisk group by not specifying the **-mdisk** flag.

-ext *extent_size*

Specifies the size of the extents for this group in MB. The **-ext** argument can have values of: 16, 32, 64, 128, 256, or 512 (MB).

Description

This command creates a new group, assigning the name (if given). The ID of the new group is returned if the command is successful.

Optionally, you can specify a list of managed disks that will be added to this group. These managed disks cannot belong to another group, and they must have a mode of unmanaged. Use the **svcinfolsmdiskcandidate** command to get a list of suitable candidates.

Each managed disk that is a member of this group will be split into extents. The storage available on these disks will be added to a pool of extents available in this group. When a virtual disk is created from this group, free extents from the pool will be used, in accordance with the policy chosen when creating the virtual disk.

All managed disks subsequently added to this group will be split into extents of the same size as assigned to the group.

When choosing an extent size, take into account the amount of storage you want to virtualize in this group. The system maintains a mapping of extents between virtual disks and managed disks. The cluster can only manage a finite number of extents (4 194 304). One cluster can virtualize the following number of extents:

- 64 TB If all managed disk groups have extent sizes of 16 MB.
- 2 PB If all managed disk groups have extent sizes of 512 MB.

Note: When an image mode VDisk is created, the MDisk group will increase in capacity by the size of the image mode VDisk (not the MDisk capacity) as the image mode VDisk may be smaller than the MDisk itself. If an extent is migrated from the image mode VDisk or MDisk to elsewhere in the group then the VDisk becomes a striped VDisk (no longer image mode) and at this point the available capacity may increase, as the extra capacity available on the MDisk (for example, that which was not part of the image mode VDisk) becomes available.

Possible failures

- CMMVC5786E The action failed because the cluster is not in a stable state.
- CMMVC5815E The managed disk (MDisk) group was not created because an entity that was specified in the command does not exist.
- CMMVC5807E The action failed because the managed disk (MDisk) cannot be changed to the specified mode.
- CMMVC5808E The action failed because the managed disk (MDisk) does not exist.
- CMMVC5858E The action failed because the virtual disk (VDisk) is in the wrong mode, the managed disk (MDisk) is in the wrong mode, or both are in the wrong mode.

An invocation example

```
svctask mkmdiskgrp -mdisk mdisk13 -ext 512
```

The resulting output

```
MDisk Group, id [1], successfully created
```

rmmdisk

The **rmmdisk** command deletes a managed disk from a managed disk group. There are some constraints on this command.

Syntax

```
▶▶ svctask — — rmmdisk — — -mdisk ———— [ mdisk_id_list ] —————▶
                                     [ mdisk_name_list ]
▶ [ -force ] [ mdisk_group_id ] —————▶
  [ mdisk_group_name ]
```

Parameters

-mdisk *mdisk_id_list* | *mdisk_name_list*

Specifies one or more managed disk IDs or names to delete from the group.

-force

Optionally specifies the force flag. If you do not supply the **-force** flag and virtual disks exist that are made from extents on one or more of the managed disks specified, the command will fail. If you do supply the force flag, and virtual disks exist that are made from extents on one or more of the managed disks specified, any data on the disks will be migrated to other disks in the group if there are enough free extents in the group. This operation might take some time.

mdisk_group_id | **mdisk_group_name**

Specifies the ID or name of the managed disk group to delete the disk, or disks, from.

Description

This command attempts to remove the managed disk or disks from the group.

Deleting a managed disk from a group can only be done if the managed disk does not contain any extents in use by a virtual disk. If there are extents in use and you do not supply the force flag, the command will fail.

Attention: If this disk being removed has already been powered down, removed, or is suffering a power outage, the migrate will be pending and will not complete until the MDisk comes back online. This also means that the MDisk will not be removed from the list of MDisks contained in the group.

If the disk has been deliberately removed, the only method of removing the MDisk is to remove the entire group itself.

You should ensure that you do not destroy any controller LUNs until you have deleted them from the MDisk group they belong to.

The **rmmdisk** command will fail if there are insufficient free extents on other disks in the mdisk group for the duration of the command. To avoid this problem, do not issue new commands that use extents until **rmmdisk** is completed.

If you do specify the force flag, an attempt will be made to migrate the extents that are in use onto other free extents within the group. If there are not enough free extents in the group, the command will fail even if the force flag is specified.

If you still want to delete the disks from the group, you have the following options:

1. Delete the virtual disk that is using the extents specified on the managed disk.
2. Add more managed disks to the group, rerun the command and specify the -force flag.

When data is being migrated off the managed disk, it might take some time for the command to be completed. The command itself will return with a success code, notifying you that migration is in progress. An event will be logged when the migration is complete and the disk will be deleted from the group at this time. You can also check the progress of any active migrations by running the **svcinfolsmigrate** command.

Possible failures

- CMMVC5786E The action failed because the cluster is not in a stable state.
- CMMVC5823E The managed disk (MDisk) was not deleted from the MDisk group because the MDisk is part of another MDisk group.
- CMMVC5824E The managed disk (MDisk) was not deleted from the MDisk group because it does not belong to the MDisk group.
- CMMVC5825E The managed disk (MDisk) was not deleted from the MDisk group because a virtual disk (VDisk) is allocated from one or more of the specified MDisks. A forced deletion is required.
- CMMVC5807E The action failed because the managed disk (MDisk) cannot be changed to the specified mode.
- CMMVC5808E The action failed because the managed disk (MDisk) does not exist.
- CMMVC6006E The managed disk (MDisk) was not deleted because the resource was busy.
- CMMVC6015E A delete request is already in progress.

An invocation example

```
svctask rmdisk -mdisk mdisk12 -force Group3
```

The resulting output

No feedback

rmdiskgrp

The **rmdiskgrp** command deletes a managed disk group so that there is no possibility to recover it.

Syntax

```
svctask -- rmdiskgrp -- [-force] [mdisk_group_id | mdisk_group_name]
```

Parameters

-force

(Optional) Specifies that all virtual disks and virtual disk-to-host mappings be deleted.

Attention: Use this parameter with extreme caution. When you use this parameter, all managed disks in the group are removed and the group itself is deleted.

mdisk_group_id | mdisk_group_name

(Required) Specifies the ID or name of the managed disk group that is to be deleted.

Description

This command completely deletes the specified managed disk group. The **-force** parameter is required if there are virtual disks created from this group or if there are managed disks in the group. Otherwise, the command fails.

Deleting a managed disk group is essentially the same as deleting a cluster or part of a cluster, because the managed disk group is the central point of control of virtualization. Because virtual disks are created using available extents in the group, mapping between virtual disk extents and managed disk extents is controlled based on the group.

Attention:

1. This command partially completes asynchronously. All virtual disks, host mappings, and copy services are deleted before the command completes. The deletion of the managed disk group then completes asynchronously.
2. Before you issue the command, ensure that you really want to delete all mapping information. Data contained on virtual disks cannot be recovered after the managed disk group has been deleted.

In detail, if you specify the **-force** parameter, and the virtual disks are still using extents in this group, the following actions are initiated or occur:

- The mappings between that disk and any host objects and the associated Copy Services relationships are deleted.
- If the virtual disk is a part of a FlashCopy mapping, the mapping is deleted.

| **Note:** If the mapping is not in the `idle_or_copied` or `stopped` states, the mapping
| is force-stopped and then deleted. Force-stopping the mapping might
| cause other FlashCopy mappings in the cluster to also be stopped. See the
| description for the `-force` parameter in the `stopfcmap` command for
| additional information.

- Any virtual disk that is in the process of being migrated into or out of the managed disk group is deleted. This frees up any extents that the virtual disk was using in another managed disk group.
- Virtual disks are deleted without first flushing the cache. Therefore, the storage controller LUNs that underlie any image mode MDisk might not contain the same data as the image mode VDisk prior to the deletion.
- If there are managed disks in the group, all disks are deleted from the group. They are returned to the unmanaged state.
- The group is deleted.

Attention: If you use the `-force` parameter to delete all the managed disk groups in your cluster, you are returned to the processing state where you were after you added nodes to the cluster. All data that is contained on the virtual disks is lost and not able to be recovered.

Possible failures

- CMMVC5786E The action failed because the cluster is not in a stable state.
- CMMVC5816E The action failed because an entity that was specified in the command does not exist.
- CMMVC5818E The managed disk (MDisk) group was not deleted because there is at least one MDisk in the group.
- CMMVC6252E The command failed authorization because the session SSH key is invalid or was deleted.
- CMMVC6253E The command failed authorization because the session SSH key does not have the requisite role.

An invocation example

```
svctask rmmdiskgrp -force Group3
```

The resulting output

No feedback

Chapter 13. Managed disk commands

The following commands enable you to work with managed disk options with the SAN Volume Controller.

When the cluster detects MDisks, it will automatically add the MDisk to the clusters list of known MDisks. If you subsequently delete the RAID that corresponds to this MDisk, the cluster will only delete this MDisk from the list if:

- the MDisk has a mode of unmanaged, that is, it does not belong to a MDisk group
- and the MDisk is offline.

chmdisk

Use the **chmdisk** command to modify the name of a managed disk.

Syntax

```
svctask -- chmdisk -- -name -- new_name_arg -- 

|  |            |   |
|--|------------|---|
|  | mdisk_id   | → |
|  | mdisk_name | → |

```

Parameters

-name *new_name_arg*

Specifies the new name to be applied to the managed disk.

mdisk_id_list | **mdisk_name_list**

Specifies the ID or name of the managed disk to modify.

Description

This command modifies the name, or label, assigned to a given managed disk. You can subsequently use the new name to refer to the managed disk.

Possible failures

- CMMVC5786E The action failed because the cluster is not in a stable state.
- CMMVC5806E The action failed because an entity that was specified in the command does not exist.
- CMMVC5808E The action failed because the managed disk (MDisk) does not exist.

An invocation example

```
svctask chmdisk -name testmdisk mdisk0
```

The resulting output

No feedback

includemdisk

Use the **includemdisk** command to include a disk that has been excluded by the cluster.

Syntax

```
svctask -- includemdisk -- [mdisk_id | mdisk_name]
```

Parameters

mdisk_id | mdisk_name

Specifies the ID or name of the managed disk to add back into the cluster.

Description

The managed disk specified is included in the cluster.

A disk might be excluded from the cluster because of multiple I/O failures. These failures might be caused by noisy links. Once a fabric-related problem has been fixed, the excluded disk can be added back into the cluster.

Executing this command against an MDisk may change its state, regardless of whether the state is reported as excluded.

Note: If an MDisk is in the excluded state, is offline and does not belong to an MDisk group, issuing an include for this MDisk will result in the MDisk record being deleted from the cluster.

Possible failures

- CMMVC5786E The action failed because the cluster is not in a stable state.
- CMMVC5806E The action failed because an entity that was specified in the command does not exist.
- CMMVC5808E The action failed because the managed disk (MDisk) does not exist.

An invocation example

```
svctask includemdisk mdisk5
```

The resulting output

```
No feedback
```

setquorum

Use the **setquorum** command to change the managed disks (MDisks) that are assigned as quorum candidate disks.

Syntax

```
svctask -- setquorum -- -quorum [0 | 1 | 2] [mdisk_id | mdisk_name]
```

Parameters

-quorum 0 | 1 | 2

Specifies the quorum index.

mdisk_id | mdisk_name

Specifies the ID or name of the managed disk to assign as a quorum disk.

Description

This command sets the managed disk to the specified quorum index.

The quorum disk is used by the cluster as a tie breaker when exactly half of the nodes that were previously a member of the cluster are now present. The use of a quorum disk prevents the cluster from being split exactly in half. Both halves either continue to operate or both halves stop. There is only *one* quorum disk; however, the cluster uses three disks as quorum candidate disks. The cluster will select the actual quorum disk from the pool of quorum candidate disks. The quorum candidate disks also hold a copy of important cluster metadata. 256 MB of contiguous space is reserved for this purpose on each quorum candidate disk.

When you issue this command, the MDisk that currently is assigned the quorum index number is set to a non-quorum disk. The cluster will automatically assign quorum indexes.

This command can be used if you want to ensure that a particular set of MDisks continue to be accessible given a cluster split.

Possible failures

- CMMVC5786E The action failed because the cluster is not in a stable state.
- CMMVC5806E The action failed because an entity that was specified in the command does not exist.
- CMMVC5810E The quorum index number for the managed disk (MDisk) was not set because the MDisk is offline.
- CMMVC5811E The quorum index number for the managed disk (MDisk) was not set because the quorum disk does not exist.
- CMMVC5812E The quorum index number for the managed disk (MDisk) was not set because the MDisk is in the wrong mode.
- CMMVC5814E The quorum index number for the managed disk (MDisk) was not set because the unique identifier (UID) type is not valid.

An invocation example

```
svctask setquorum -quorum 2 mdisk7
```

The resulting output

No feedback

Chapter 14. FlashCopy commands

The following commands enable you to work with FlashCopy methods and functions with the SAN Volume Controller.

chfcconsistgrp

Use the **chfcconsistgrp** command to modify the name of an existing consistency group.

Syntax

```
svctask -- chfcconsistgrp -- -name -- new_name_arg --  
└── fc_consist_group_id ───┬──  
    └── fc_consist_group_name ───┘
```

Parameters

-name *new_name_arg*

(Required) Specifies the new name to assign to the consistency group.

fc_consist_group_id | **fc_consist_group_name**

(Required) Specifies the ID or existing name of the consistency group that you want to modify.

Description

This command changes the name of the specified consistency group.

Possible failures

- CMMVC5786E The action failed because the cluster is not in a stable state.
- CMMVC5891E The name of the FlashCopy consistency group was not modified because the name is not valid.
- CMMVC5893E The action failed because an entity that was specified in the command does not exist.
- CMMVC6252E The command failed authorization because the session SSH key is wrong or was deleted.
- CMMVC6253E The command failed authorization because the session SSH key does not have the requisite role.

An invocation example

```
svctask chfcconsistgrp -name testgrp1 fcconsistgrp1
```

The resulting output

```
No feedback
```

chfcmap

The **chfcmap** command modifies certain attributes of an existing mapping, one attribute at a time.

Syntax

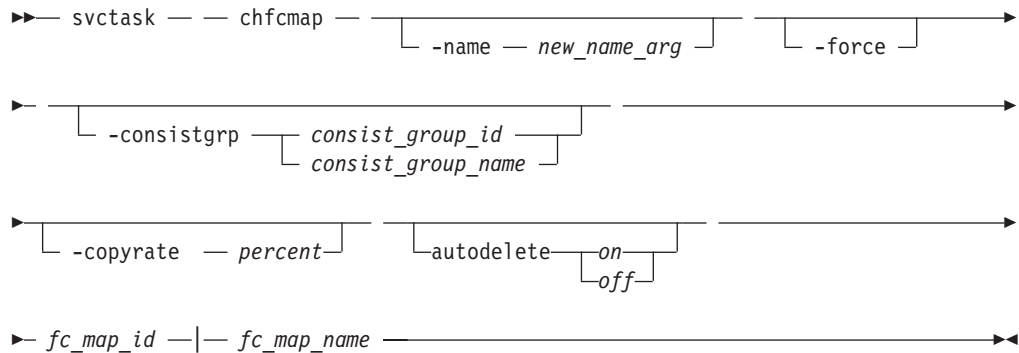

Parameters

-name *new_name_arg*

(Optional) Specifies the new name to assign to the mapping. This parameter is mutually exclusive with the other optional parameters.

-force

(Optional) Specifies that the mapping be modified to a stand-alone mapping (equivalent to creating the mapping without a consistency group ID). You cannot use the **-force** parameter with the **-name**, **-consistgrp** or **-autodelete** parameters.

Note: The mapping cannot be removed from the consistency group while the group is active.

-consistgrp *consist_group_id | consist_group_name*

(Optional) Specifies the consistency group for which you want to modify the mapping. You cannot use the **-consistgrp** parameter with the **-name**, **-force**, or **-autodelete** parameters.

Note: The consistency group cannot be modified while a copy is active or while the target consistency group is active.

-copyrate *percent*

(Optional) Specifies the priority of the background copy rate, expressed as a percentage. You cannot use the **-copyrate** parameter with the **-name** parameter.

-autodelete *on | off*

(Optional) Specifies that the deletion function be turned on or off for the specified mapping. When you specify the **-autodelete on** parameter, you are directing the system to delete a mapping when the background copy completes. If the background copy is already complete, the mapping is deleted immediately. You cannot use the **-autodelete** parameter with the **-name**, **-force**, or **-consistgrp** parameters.

fc_map_id | fc_map_name

(Required) Specifies the ID or name of the mapping to modify.

Description

This command modifies the attributes of an existing mapping. You can only modify the consistency group attribute when the mapping is in the `idle_or_copied` or `stopped` states. If you are adding the mapping to a consistency group, that consistency group must be in the `idle_or_copied` or `stopped` state. If you have

created several FlashCopy mappings for a group of VDisks that contain elements of data for the same application, you might find it convenient to assign these mappings to a single FlashCopy consistency group. Then you can issue a single prepare or start command for the whole group, so that, for example, all the files for a particular database are copied at the same time.

Possible failures

- CMMVC5753E The object specified does not exist
- CMMVC5786E The action failed because the cluster is not in a stable state.
- CMMVC5888E The action failed because an entity that was specified in the command does not exist.
- CMMVC5913E The properties of the FlashCopy mapping were not modified because the mapping or consistency group is in the preparing state.
- CMMVC5914E The properties of the FlashCopy mapping were not modified because the mapping or consistency group is in the prepared state.
- CMMVC5915E The properties of the FlashCopy mapping were not modified because the mapping or consistency group is in the copying state.
- CMMVC5916E The properties of the FlashCopy mapping were not modified because the mapping or consistency group is in the suspended state.
- CMMVC5921E The properties of the FlashCopy mapping were not modified because the consistency group is not idle.
- CMMVC6215E The FlashCopy mapping was not created or modified because the consistency group already contains the maximum number of mappings.
- CMMVC6252E The command failed authorization because the session SSH key is wrong or was deleted.
- CMMVC6253E The command failed authorization because the session SSH key does not have the requisite role.
- CMMVC6240E The properties of the FlashCopy mapping were not modified because the mapping or consistency group is in the stopping state.

An invocation example

```
svctask chfcmap -name testmap 1
```

The resulting output

No feedback

mkfcconsistgrp

The **mkfcconsistgrp** command creates a new FlashCopy consistency group and identification name.

Syntax

```
svctask -- mkfcconsistgrp -- [-name consist_group_name]
```

Parameters

-name *consist_group_name*

(Optional) Specifies a name for the consistency group. If you do not specify a

consistency group name, a name is automatically assigned to the consistency group. For example, if the next available consistency group ID is id=2, the consistency group name is fcstgrp2.

Description

This command creates a new consistency group and identification name. The ID of the new group is displayed when the command process completes.

If you have created several FlashCopy mappings for a group of VDisks that contain elements of data for the same application, you might find it convenient to assign these mappings to a single FlashCopy consistency group. You can then issue a single prepare or start command for the whole group, so that, for example, all the files for a particular database are copied at the same time.

Possible failures

- CMMVC5786E The action failed because the cluster is not in a stable state.
- CMMVC5891E The FlashCopy consistency group was not created because the name is not valid.
- CMMVC5892E The FlashCopy consistency group was not created because it already exists.
- CMMVC6252E The command failed authorization because the session SSH key is wrong or was deleted.
- CMMVC6253E The command failed authorization because the session SSH key does not have the requisite role.

An invocation example

```
svctask mkfcconsistgrp
```

The resulting output

```
FlashCopy Consistency Group, id [1], successfully created
```

mkfcmap

The **mkfcmap** command creates a new FlashCopy mapping, which maps a source virtual disk to a target virtual disk for subsequent copying.

Syntax

```

▶▶ svctask — — mkfcmap — — -source [ src_vdisk_id ] [ src_vdisk_name ]
▶ -target [ target_vdisk_id ] [ target_vdisk_name ] [ -name — new_name_arg ]
▶ [ -consistgrp [ consist_group_id ] [ consist_group_name ] ] [ -copyrate percent ]
▶ [ autodelete ]

```

Parameters

-source *src_vdisk_id* | *src_vdisk_name*

(Required) Specifies the ID or name of the source virtual disk.

-target *target_vdisk_id* | *target_vdisk_name*

(Required) Specifies the ID or name of the destination virtual disk.

-name *new_name_arg*

(Optional) Specifies the name to assign to the new mapping.

-consistgrp *consist_group_id* | *consist_group_name*

(Optional) Specifies the consistency group to add the new mapping to. If you do not specify a consistency group, the mapping is treated as a stand-alone mapping.

-copyrate percent

(Optional) Specifies the priority of the background copy rate. This value is also used as the priority of the stopping copy process when a mapping is in the stopping state. The value is expressed as a percentage. The default is 50.

-autodelete

(Optional) Specifies that a mapping be deleted when the background copy completes. The default, which applies if this parameter is not entered, is that **autodelete** is set to off.

Description

This command creates a new FlashCopy mapping logical object. This mapping persists until it is deleted or until it is automatically deleted when the background copy completes. The mapping specifies the source and destination virtual disks. The destination must be identical in size to the source, or the mapping will fail. Issue the **svcinfo lsvdisk -bytes** command to find the exact size of the source VDisk that you want to create a target disk of the same size. The requested source VDisk cannot be the target of another FlashCopy mapping, and cannot be the source of more than 15 existing FlashCopy mappings. The given target VDisk cannot be a member of any existing FlashCopy mapping.

The mapping can optionally be given a name and assigned to a consistency group. These are groups of mappings that can be started at the same time. This enables multiple virtual disks to be copied at the same time, which creates a consistent copy of multiple disks. This consistent copy of multiple disks is required by some database products in which the database and log files reside on different disks.

If no consistency group is defined, the mapping is assigned into the default group 0. This is a special group that cannot be started as a whole. Mappings in this group can only be started on an individual basis.

The background copy rate specifies the priority that must be given to completing the copy. If 0 is specified, there is no background copy process for this mapping. The default is 50.

Possible failures

Note: If you receive an error for this command that indicates that the licensed virtualization capacity has been exceeded, then the command was still effective. However, the return code will indicate the license violation.

- CMMVC5786E The action failed because the cluster is not in a stable state.

- CMMVC5881E The FlashCopy mapping was not created because an entity that was specified in the command does not exist.
- CMMVC5882E The FlashCopy mapping was not created because a mapping for the source or target virtual disk (VDisk) already exists.
- CMMVC5883E The FlashCopy mapping was not created because the recovery I/O group is associated with the source or target virtual disk (VDisk).
- CMMVC5884E The FlashCopy mapping was not created because the source or target virtual disk (VDisk) cannot be a member of a Metro Mirror mapping.
- CMMVC5885E The FlashCopy mapping was not created because this source or target virtual disk (VDisk) cannot be a member of a FlashCopy mapping.
- CMMVC5886E The FlashCopy mapping was not created because the source or target virtual disk (VDisk) is associated with the recovery I/O group.
- CMMVC5922E The FlashCopy mapping was not created because the destination virtual disk (VDisk) is too small.
- CMMVC5923E The FlashCopy mapping was not created because the I/O group is offline.
- CMMVC5924E The FlashCopy mapping was not created because the source and target virtual disks (VDisks) are different sizes.
- CMMVC5917E The FlashCopy mapping was not created because there is no memory to create the bitmap.
- CMMVC5920E The FlashCopy mapping was not created because the consistency group is not idle.
- CMMVC6215E The FlashCopy mapping was not created or modified because the consistency group already contains the maximum number of mappings.
- CMMVC6252E The command failed authorization because the session SSH key is invalid or was deleted.
- CMMVC6253E The command failed authorization because the session SSH key does not have the requisite role.
- CMMVC6244E The FlashCopy mapping was not created because the source virtual disk (VDisk) cannot be the target for a FlashCopy mapping.
- CMMVC6245E The FlashCopy mapping was not created because the source virtual disk (VDisk) is already in the maximum number of FlashCopy mappings.
- CMMVC6246E The FlashCopy mapping was not created because the target virtual disk (VDisk) is already a source vdisk in a FlashCopy mapping.
- CMMVC6247E The FlashCopy mapping was not created because the target virtual disk (VDisk) is already a target vdisk in a FlashCopy mapping.

An invocation example

```
svctask mkfcmap -source 0 -target 2 -name mapone
```

The resulting output

```
FlashCopy mapping, id [1], successfully created
```

prestartfcconsistgrp

The **prestartfcconsistgrp** command prepares a group of mappings (a consistency group) so that the consistency group mapping can be started. This command flushes the cache of any data destined for the source virtual disk and forces the cache into the write-through mode until the consistency group mapping is started.

Syntax

```
svctask -- prestartfcconsistgrp -- [ fc_consist_group_id | fc_consist_group_name ]
```

Parameters

fc_consist_group_id | fc_consist_group_name

(Required) Specifies the name or ID of the consistency group that you want to prepare.

Description

This command prepares a group of mappings (at a consistency group level) to subsequently start. The preparation step ensures that any data that resides in the cache for the source virtual disk is first flushed to disk. This step ensures that the copy that is made is consistent with what the operating system expects on the disk.

Issue the **svctask prestartfcconsistgrp** command to prepare the FlashCopy consistency group before the copy process can be started. When you have assigned several mappings to a FlashCopy consistency group, you can issue a single prepare command for the whole group, to prepare all the mappings at once.

The consistency group must be in the `idle_or_copied` or `stopped` states before it can be prepared. The group enters the `preparing` state. After the preparation is complete, the group changes to the `prepared` state. At this point, the group is ready to start.

Preparing and the subsequent starting is usually performed on a consistency group basis versus individual FlashCopy mappings. Only stand-alone mappings can be prepared on their own. A FlashCopy mapping must be prepared before it can be started.

Possible failures

- CMMVC5786E The action failed because the cluster is not in a stable state.
- CMMVC5888E The action failed because an entity that was specified in the command does not exist.
- CMMVC5890E The FlashCopy mapping was not prepared because preparing consistency group 0 is not a valid operation.
- CMMVC5901E The FlashCopy mapping was not prepared because the mapping or consistency group is already in the `preparing` state.
- CMMVC5902E The FlashCopy mapping was not prepared because the mapping or consistency group is already in the `prepared` state.
- CMMVC5903E The FlashCopy mapping was not prepared because the mapping or consistency group is already in the `copying` state.
- CMMVC5904E The FlashCopy mapping was not prepared because the mapping or consistency group is already in the `suspended` state.
- CMMVC5918E The FlashCopy mapping was not prepared because the I/O group is offline.
- CMMVC6031E The operation was not performed because the FlashCopy consistency group is empty.

- CMMVC6239E The FlashCopy mapping was not prepared because the mapping or consistency group is in the stopping state.
- CMMVC6252E The command failed authorization because the session SSH key is invalid or was deleted.
- CMMVC6253E The command failed authorization because the session ssh key does not have the requisite role.

An invocation example

```
svctask prestartfcconsistgrp 1
```

The resulting output

No feedback

prestartfcmap

The **prestartfcmap** command prepares a FlashCopy mapping so that it can be processed. This command flushes the cache of any data that is destined for the source virtual disk and forces the cache into the write-through mode until the mapping is started.

Syntax

```
svctask -- prestartfcmap -- [fc_map_id | fc_map_name]
```

Parameters

fc_map_id | fc_map_name

(Required) Specifies the name or ID of the mapping to prepare.

Description

This command prepares a single mapping for subsequent starting. The preparation step ensures that any data that resides in the cache for the source virtual disk is first transferred to disk. This step ensures that the copy that is made is consistent with what the operating system expects on the disk.

The mapping must be in the `idle_or_copied` or `stopped` states before it can be prepared. When the **prestartfcmap** command is processed, the mapping enters the `preparing` state. After the preparation is complete, it changes to the `prepared` state. At this point, the mapping is ready to start.

Attention: This command can take a considerable amount of time to complete.

Possible failures

- CMMVC5786E The action failed because the cluster is not in a stable state.
- CMMVC5888E The action failed because an entity that was specified in the command does not exist.
- CMMVC5890E The FlashCopy mapping was not prepared because preparing consistency group 0 is not a valid operation.
- CMMVC5901E The FlashCopy mapping was not prepared because the mapping or consistency group is already in the `preparing` state.

- CMMVC5902E The FlashCopy mapping was not prepared because the mapping or consistency group is already in the prepared state.
- CMMVC5903E The FlashCopy mapping was not prepared because the mapping or consistency group is already in the copying state.
- CMMVC5904E The FlashCopy mapping was not prepared because the mapping or consistency group is already in the suspended state.
- CMMVC5918E The FlashCopy mapping was not prepared because the I/O group is offline.
- CMMVC6239E The FlashCopy mapping was not prepared because the mapping or consistency group is in the stopping state.
- CMMVC6252E The command failed authorization because the session SSH key is wrong or was deleted.
- CMMVC6253E The command failed authorization because the session SSH key does not have the requisite role.

An invocation example

```
svctask prestartfcmap 1
```

The resulting output

No feedback

rmfcconsistgrp

The **rmfcconsistgrp** command deletes a FlashCopy consistency group.

Syntax

```

▶▶ svctask — — rmfcconsistgrp — — [ -force ] —————▶
|
| [ fc_consist_group_id ] —————▶
| [ fc_consist_group_name ] —————▶

```

Parameters

-force

(Optional) Specifies that all mappings that are associated with a consistency group that you want to delete be moved into consistency group 0. This parameter is only used if the consistency group that you want to delete is not free of mappings.

fc_consist_group_id | fc_consist_group_name

(Required) Specifies the ID or name of the consistency group that you want to delete.

Description

This command deletes the specified FlashCopy consistency group. If there are mappings that are members of the consistency group, the command fails unless you specify the **-force** parameter. When you specify the **-force** parameter, all the mappings that are associated with the consistency group that you want to delete are assigned to the default consistency group 0.

Note: If any of the mappings in the group are in the Copying, Stopping or Suspended states when you issue the `-force` parameter, these mappings are force-stopped before being moved to consistency group 0. This causes any mappings that are dependent on these mappings to be stopped also. See the description for the `-force` parameter in the `stopfcmap` command.

If you want to delete all the mappings in the consistency group as well, you must delete them using the `svctask rmfcmap` command.

Possible failures

- CMMVC5786E The action failed because the cluster is not in a stable state.
- CMMVC5893E The action failed because an entity that was specified in the command does not exist.
- CMMVC5894E The FlashCopy consistency group was not deleted because you are trying to delete consistency group 0 or the name of the consistency group is not valid.
- CMMVC5895E The FlashCopy consistency group was not deleted because it contains mappings. To delete this consistency group, a forced deletion is required.
- CMMVC6252E The command failed authorization because the session SSH key is wrong or was deleted.
- CMMVC6253E The command failed authorization because the session SSH key does not have the requisite role.

An invocation example

```
svctask rmfcconsistgrp fcconsistgrp1
```

The resulting output

No feedback

rmfcmap

The `rmfcmap` command deletes an existing mapping.

Syntax

```
svctask -- rmfcmap [ -force ] [ fc_map_id | fc_map_name ]
```

Parameters

`-force`

(Optional) This parameter is required if the FlashCopy mapping is in the stopped state. Using the `rmfcmap -force` command brings the target VDisk online.

`fc_map_id` | `fc_map_name`

(Required) Specifies the ID or name of the FlashCopy mapping to delete.

Description

The **rmfcmap** command deletes the specified mapping if the mapping is in the `idle_or_copied` or `stopped` state. If it is in the `stopped` state, the **-force** parameter is required. If the mapping is in any other state, you must stop the mapping before it can be deleted.

Deleting a mapping only deletes the logical *relationship* between the two virtual disks; it does not affect the virtual disks themselves. However, if you force the deletion, the target virtual disk (which might contain inconsistent data) is brought back online.

Possible failures

- CMMVC5786E The action failed because the cluster is not in a stable state.
- CMMVC5889E The FlashCopy mapping was not deleted because an entity that was specified in the command does not exist.
- CMMVC5896E The FlashCopy mapping was not deleted because the mapping or consistency group is in the `preparing` state. The mapping or consistency group must be stopped first.
- CMMVC5897E The FlashCopy mapping was not deleted because the mapping or consistency group is in the `prepared` state. The mapping or consistency group must be stopped first.
- CMMVC5898E The FlashCopy mapping was not deleted because the mapping or consistency group is in the `copying` state. The mapping or consistency group must be stopped first.
- CMMVC5899E The FlashCopy mapping was not deleted because the mapping or consistency group is in the `stopped` state. To delete the mapping, a forced deletion is required.
- CMMVC5900E The FlashCopy mapping was not deleted because the mapping or consistency group is in the `suspended` state. The mapping or consistency group must be stopped first.
- CMMVC6241E The FlashCopy mapping was not deleted because the mapping or consistency group is in the `stopping` state. The mapping or consistency group must complete the stop operation first.
- CMMVC6252E The command failed authorization because the session SSH key is wrong or was deleted.
- CMMVC6253E The command failed authorization because the session SSH key does not have the requisite role.

An invocation example

```
svctask rmfcmap testmap
```

The resulting output

```
No feedback
```

startfcconsistgrp

The **startfcconsistgrp** command starts a FlashCopy consistency group of mappings. This command makes a point-in-time copy of the source virtual disk at the moment that the command is processed.

Syntax

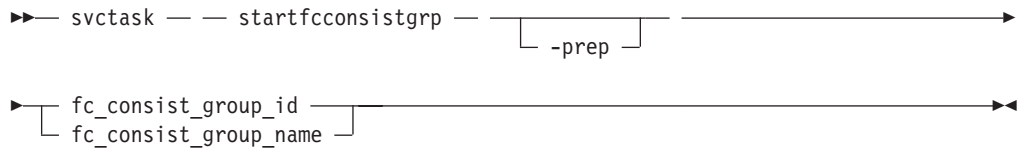

Parameters

-prep

(Optional) Specifies that the designated FlashCopy consistency group be prepared prior to starting the FlashCopy consistency group. A FlashCopy consistency group must be prepared before it can be started. When you use this parameter, you are telling the system to run through the prepare process as if you had issued the **prestartfcconsistgrp** command.

fc_consist_group_id | fc_consist_group_name

(Required) Specifies the ID or name of the consistency group mapping to start.

Description

This command starts a consistency group mapping, which results in a point-in-time copy of the source virtual disks.

Note: The **startfcconsistgrp** command can take some time to process particularly if you have specified the **-prep** parameter. If you use the **-prep** parameter, you give additional processing control to the system because the system must prepare the mapping before the mapping is started. If you want to keep control when the consistency group mapping starts, you must issue the **prestartfcconsistgrp** command before you issue the **startfcconsistgrp** command.

Possible failures

- CMMVC5786E The action failed because the cluster is not in a stable state.
- CMMVC5888E The action failed because an entity that was specified in the command does not exist.
- CMMVC5890E The FlashCopy mapping or consistency group was not started because starting consistency group 0 is not a valid operation.
- CMMVC5905E The FlashCopy mapping or consistency group was not started because the mapping or consistency group is in the idle state. The mapping or consistency group must be prepared first.
- CMMVC5906E The FlashCopy mapping or consistency group was not started because the mapping or consistency group is in the preparing state.
- CMMVC5907E The FlashCopy mapping or consistency group was not started because the mapping or consistency group is already in the copying state.
- CMMVC5908E The FlashCopy mapping or consistency group was not started because the mapping or consistency group is in the stopped state. The mapping or consistency group must be prepared first.
- CMMVC5909E The FlashCopy mapping or consistency group was not started because the mapping or consistency group is in the suspended state.
- CMMVC5919E The FlashCopy mapping or consistency group was not started because the I/O group is offline.

- CMMVC6209E The FlashCopy mapping or consistency group could not be started in a reasonable time. The mapping or group is instead being prepared.
- CMMVC6242E The FlashCopy mapping or consistency group was not started because the mapping or consistency group is in the stopping state. The mapping or consistency group must first complete the stop operation and then be prepared.
- CMMVC6252E The command failed authorization because the session SSH key is invalid or was deleted.
- CMMVC6253E The command failed authorization because the session SSH key does not have the requisite role.

An invocation example

```
svctask startfcconsistgrp -prep 2
```

The resulting output

No feedback

startfcmap

The **startfcmap** command starts a FlashCopy mapping. This command makes a point-in-time copy of the source virtual disk at the moment that the command is processed.

Syntax

```

▶▶— svctask — — startfcmap — — [ -prep ] [ fc_map_id | fc_map_name ]

```

Parameters

-prep

(Optional) Specifies that the designated mapping be prepared prior to starting the mapping. A mapping must be prepared before it can be started. When you use this parameter, you are telling the system to run through the prepare process the same as if you had issued the **prestartfcmap** command.

fc_map_id | fc_map_name

(Required) Specifies the ID or name of the mapping to start.

Description

This command starts a single mapping which results in a point-in-time copy of the source virtual disks.

Note: The **startfcmap** command can take some time to process particularly if you have specified the **-prep** parameter. If you use the **-prep** parameter, you give additional processing control to the system. The system must prepare the mapping before the mapping is started. If you want to keep control when the mapping starts, you must issue the **prestartfcmap** command before you issue the **startfcmap** command.

Possible failures

- CMMVC5786E The action failed because the cluster is not in a stable state.

- CMMVC5888E The action failed because an entity that was specified in the command does not exist.
- CMMVC5890E The FlashCopy mapping or consistency group was not started because starting consistency group 0 is not a valid operation.
- CMMVC5905E The FlashCopy mapping or consistency group was not started because the mapping or consistency group is in the idle state. The mapping or consistency group must be prepared first.
- CMMVC5906E The FlashCopy mapping or consistency group was not started because the mapping or consistency group is in the preparing state.
- CMMVC5907E The FlashCopy mapping or consistency group was not started because the mapping or consistency group is already in the copying state.
- CMMVC5908E The FlashCopy mapping or consistency group was not started because the mapping or consistency group is in the stopped state. The mapping or consistency group must be prepared first.
- CMMVC5909E The FlashCopy mapping or consistency group was not started because the mapping or consistency group is in the suspended state.
- CMMVC5919E The FlashCopy mapping or consistency group was not started because the I/O group is offline.
- CMMVC6209E The FlashCopy mapping or consistency group could not be started in a reasonable time. The mapping or group is instead being prepared.
- CMMVC6242E The FlashCopy mapping or consistency group was not started because the mapping or consistency group is in the stopping state. The mapping or consistency group must first complete the stop operation and then be prepared.
- CMMVC6252E The command failed authorization because the session SSH key is wrong or was deleted.
- CMMVC6253E The command failed authorization because the session SSH key does not have the requisite role.

An invocation example

```
svctask startfcmap -prep 2
```

The resulting output

No feedback

stopfcconsistgrp

The **stopfcconsistgrp** command stops all processing that is associated with a FlashCopy consistency group that is in one of the following processing states: idle_or_copied, prepared, copying, stopping, or suspended.

Syntax

```

▶— svctask — — stopfcconsistgrp — —————▶
                                └── -force ─┘

▶ ┌── fc_consist_group_id ─────────────────────────────────▶
└── fc_consist_group_name ─────────────────────────────────▶

```

Parameters

-force

(Optional) Specifies that all processing that is associated with the mappings of the designated consistency group be stopped immediately.

Note: When you use this parameter, all FlashCopy mappings that depend on the mappings in this group (as listed by the **lsfcmapdependentmaps** command) are also stopped.

fc_consist_group_id | fc_consist_group_name

(Required) Specifies the name or ID of the consistency group that you want to stop.

Description

This command stops a group of mappings (in a consistency group). If the copy process is stopped, the target disk becomes unusable unless it already contained a complete image of the source (that is, unless the map had a "progress" of 100 as shown by the **-lsfcmap** command). Before you can use the destination disk, the group of mappings must once again be prepared and restarted.

If the consistency group is in the IDLE_COPIED state then the **stopfcconsistgrp** command completes processing with a good status and the group stays in the IDLE_COPIED state.

Note: This is a change in behaviour from earlier releases where maps that were processed with an IDLE_COPIED state would move to a STOPPED state on receipt of this command.

Possible failures

- CMMVC5786E The action failed because the cluster is not in a stable state.
- CMMVC5888E The action failed because an entity that was specified in the command does not exist.
- CMMVC5890E The FlashCopy mapping or consistency group was not stopped because starting consistency group 0 is not a valid operation.
- CMMVC5911E The FlashCopy mapping or consistency group was not stopped because the mapping or consistency group is in the preparing state.
- CMMVC5912E The FlashCopy mapping or consistency group was not stopped because the mapping or consistency group is already in the stopped state.
- CMMVC6243E The FlashCopy mapping or consistency group was not stopped because the mapping or consistency group is already in the stopping state.
- CMMVC6252E The command failed authorization because the session SSH key is invalid or was deleted.
- CMMVC6253E The command failed authorization because the session SSH key does not have the requisite role.

An invocation example

```
svctask stopfcconsistgrp testmapone
```

The resulting output

No feedback

stopfcmap

The **stopfcmap** command stops all processing that is associated with a FlashCopy mapping that is in one of the following processing states: `idle_or_copied`, `prepared`, `copying`, `stopping`, or `suspended`.

Syntax

```
svctask -- stopfcmap [-force] [fc_map_id | fc_map_name]
```

Parameters

-force

(Optional) Specifies that all processing that is associated with the designated mapping be stopped immediately.

Note: When you use this parameter all FlashCopy mappings that depend on this mapping (as listed by the **-lsfcmapdependentmaps** command) will also be stopped.

fc_map_id | fc_map_name

(Required) Specifies the name or ID of the mapping to stop.

Description

This command stops a single mapping. If the copy process is stopped, the target disk becomes unusable unless it already contained a complete image of the source (that is, unless the map had a "progress" of 100 as shown by the **-lsfcmap** command). Before you can use the destination disk, the mapping must once again be prepared and then restarted (unless the destination disk already contained a complete image).

Only stand-alone mappings can be stopped using the **stopfcmap** command. Mappings that belong to a consistency group must be stopped using the **stopfcconsistgrp** command.

If the mapping is in the `IDLE_COPIED` state then the **stopfcmap** command completes processing with a good status and the mapping stays in the `IDLE_COPIED` state.

Note: This is a change in behaviour from earlier releases where a map that was processed with an `IDLE_COPIED` state was moved to a `STOPPED` state on receipt of this command. This change in behaviour might break customer scripts which depended on the old behaviour.

Possible failures

- CMMVC5786E The action failed because the cluster is not in a stable state.
- CMMVC5888E The action failed because an entity that was specified in the command does not exist.
- CMMVC5890E The FlashCopy mapping or consistency group was not stopped because starting consistency group 0 is not a valid operation.
- CMMVC5911E The FlashCopy mapping or consistency group was not stopped because the mapping or consistency group is in the preparing state.

- CMMVC5912E The FlashCopy mapping or consistency group was not stopped because the mapping or consistency group is already in the stopped state.
- CMMVC6030E The operation was not performed because the FlashCopy mapping is part of a consistency group. The action must be performed at the consistency group level.
- CMMVC6243E The FlashCopy mapping or consistency group was not stopped because the mapping or consistency group is already in the stopping state.
- CMMVC6252E The command failed authorization because the session SSH key is invalid or was deleted.
- CMMVC6253E The command failed authorization because the session SSH key does not have the requisite role.

An invocation example

```
svctask stopfcmap testmapone
```

The resulting output

```
No feedback
```

Chapter 15. Metro Mirror and Global Mirror commands

The following Copy Service commands enable you to work with the Metro Mirror and Global Mirror services that the SAN Volume Controller provides.

chpartnership

The **chpartnership** command modifies the bandwidth of the partnership between the local cluster and the remote cluster that is specified in the command. This affects the bandwidth available for background copy in a cluster partnership by either Metro Mirror or Global Mirror.

Syntax

```
svctask -- chpartnership -- -bandwidth -- bandwidth_in_mbps --  
└─ remote_cluster_id ─┬───────────────────────────────────────────▶  
└─ remote_cluster_name ─┘
```

Parameters

-bandwidth *bandwidth_in_mbps*

(Required) Specifies the new bandwidth in megabytes per second (MBps). This parameter might be set to a value that is greater than the intercluster links can sustain. If so, the actual copy rate defaults to what is available on the link. The default bandwidth is 50.

remote_cluster_id | **remote_cluster_name**

(Required) Specifies the cluster ID or name of the remote cluster. The intracluster bandwidth cannot be modified so, if you enter the local cluster name or ID, an error occurs.

Description

This command modifies the bandwidth of the partnership between the local cluster and the remote cluster that is specified in the command. This affects the bandwidth available for a background copy in Metro Mirror or Global Mirror relationships, in the direction from the local to the remote cluster. To modify the background copy bandwidth in the other direction (remote cluster → local cluster), it is necessary to issue the corresponding **chpartnership** command to the remote cluster.

Possible failures

- CMMVC5786E The action failed because the cluster is not in a stable state.
- CMMVC5927E The action failed because the cluster ID is not valid.
- CMMVC6252E The command failed authorization because the session SSH key is wrong or was deleted.
- CMMVC6253E The command failed authorization because the session SSH key does not have the requisite role.

An invocation example

```
svctask chpartnership -bandwidth 20 cluster1
```

The resulting output

No feedback

chrconsistgrp

The **chrconsistgrp** command modifies the name of an existing Metro Mirror or Global Mirror consistency group.

Syntax

```
svctask -- chrconsistgrp -- -name -- new_name_arg --  
└─ rc_consist_group_name ────────────────────────────────────▶  
└─ rc_consist_group_id ────────────────────────────────────▶
```

Parameters

-name *new_name_arg*

(Required) Specifies the new name to assign to the consistency group.

rc_consist_group_name | **rc_consist_group_id**

(Required) Specifies the ID or existing name of the consistency group you want to modify.

Description

This command changes the name of the specified consistency group.

Possible failures

- CMMVC5786E The action failed because the cluster is not in a stable state.
- CMMVC5937E The action failed because an entity that was specified in the command does not exist.
- CMMVC6252E The command failed authorization because the session SSH key is wrong or was deleted.
- CMMVC6253E The command failed authorization because the session SSH key does not have the requisite role.

An invocation example

Change the name of the consistency group called `rc_testgrp` to `rctestone`.

```
svctask chrconsistgrp -name rctestone rc_testgrp
```

The resulting output

No feedback

chrrelationship

The **chrrelationship** command enables you to modify certain attributes of an existing relationship such as add a relationship to a consistency group, remove a relationship from a consistency group, and change the name of the relationship. You can only change one attribute at a time per command submittal.

Syntax

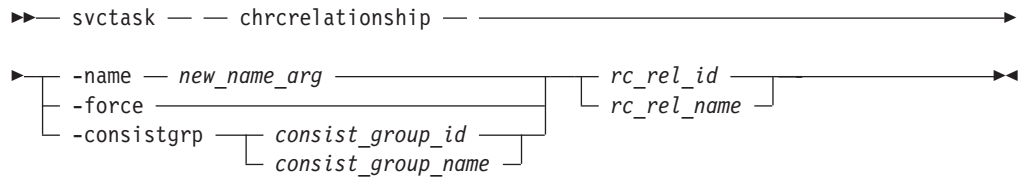

Parameters

-name *new_name_arg*

(Optional) Specifies a new label to assign to the relationship.

This parameter is required if you do not specify the **-consistgrp** or **-force** parameter.

-consistgrp *consist_group_id* | *consist_group_name*

(Optional) Specifies a new consistency group to assign the relationship to. Only relationships of the same copy type (Metro Mirror or Global Mirror) can be assigned to the same consistency group. You cannot use this parameter with the **-name**, or **-force** parameters.

This parameter is required if you do not specify the **-name** or **-force** parameter.

-force

(Optional) Specifies that you want the system to remove the relationship from a consistency group making the relationship a standalone relationship. You cannot use this parameter with the **-name**, or **-consistgrp** parameters.

This parameter is required if you do not specify the **-name** or **-consistgrp** parameter.

rc_rel_name | **rc_rel_id**

(Required) Specifies the ID or name of the relationship.

Description

This command modifies the specified attributes of the relationship supplied, one attribute at a time. That is, all three optional parameters are mutually exclusive. In addition to changing the name of a consistency group, this command can be used for the following purposes.

- **Add a relationship to a group.** A standalone relationship can be added to a consistency group by specifying the **-consistgrp** parameter and the name or ID of the consistency group. The relationship and consistency group must both be connected when the command is issued, and both must have the same:
 - Master cluster
 - Auxiliary cluster
 - State (unless the group is empty)
 - Primary (unless the group is empty)
 - Type (unless the group is empty)

When the first relationship is added to an empty group, the group takes on the same state, primary (copy direction), and type (Metro or Global Mirror) as the relationship. Subsequent relationships must have the same state, copy direction, and type as the group in order to be added to it. A relationship can only belong to one consistency group.

- **Remove a relationship from a group.** A relationship can be removed from a consistency group by simply specifying the **-force** parameter and the name or ID of the relationship. You do not have to specify or confirm the name of the consistency group, so it is recommended that you verify which group the relationship belongs to before issuing this command.

This form of the modify relationship command succeeds in the connected or disconnected states. If the clusters are disconnected, then the relationship is only removed from the consistency group on the local cluster, at the time the command is issued. When the clusters are reconnected, the relationship is automatically removed from the consistency group on the other cluster. Alternatively, you can issue an explicit modify (**chrrelationship**) command to remove the relationship from the group on the other cluster while it is still disconnected.

Note: If you remove all relationships from the group, the relationship type is reset to `empty_group`. Then, when you add a relationship to the empty group, the group again takes on the same type as the relationship.

- **Move a relationship from one group to another** To move a relationship between two consistency groups you must issue the **chrrelationship** command twice. First use the **-force** parameter to remove the relationship from its current group, then use the **-consistgrp** parameter and the name of the new consistency group it is to be added to.

Possible failures

- CMMVC5786E The action failed because the cluster is not in a stable state.
- CMMVC5935E The action failed because an entity that was specified in the command does not exist.
- CMMVC6234E The copy type differs from other copies already in the consistency group.
- CMMVC6252E The command failed authorization because the session SSH key is wrong or was deleted.
- CMMVC6253E The command failed authorization because the session SSH key does not have the requisite role.

An invocation example

Change the name of the relationship `rccopy1` to `testrel`

```
svctask chrrelationship -name testrel rccopy1
```

Add relationship `rccopy2` to group called `newgroup`.

```
svctask chrrelationship -consistgrp newgroup rccopy2
```

Remove relationship `rccopy3` from whichever consistency group it is a member of.

```
svctask chrrelationship -force rccopy3
```

The resulting output

No feedback

There is no feedback in any of these cases.

mkpartnership

The **mkpartnership** command establishes a one-way Metro Mirror or Global Mirror partnership between the local cluster and a remote cluster.

Syntax

To establish a fully functional Metro Mirror or Global Mirror partnership, you must issue this command to both clusters. This step is a prerequisite to creating Metro Mirror or Global Mirror relationships between VDisks on the clusters.

```
svctask -- mkpartnership -- [-bandwidth bandwidth_in_mbps]
                                remote_cluster_id
                                remote_cluster_name
```

Parameters

-bandwidth *bandwidth_in_mbps*

(Optional) Specifies the bandwidth that is used by the background copy process between the clusters. It can be used to adjust the bandwidth used by Metro Mirror or Global Mirror for the initial background copy process. The bandwidth defaults to 50 MBps (megabytes per second) if you do not specify it. Set the bandwidth to a value that is less than or equal to the bandwidth that can be sustained by the intercluster link. If the **-bandwidth** parameter is set to a higher value than the link can sustain, the background copy process uses the actual available bandwidth. See the *IBM System Storage SAN Volume Controller: Software Installation and Configuration Guide* for more information about the effect that background copy bandwidth has on foreground I/O latency.

remote_cluster_id | **remote_cluster_name**

(Required) Specifies the cluster ID or name of the remote cluster. Issue the **svctask lsclustercandidate** command to list the remote clusters that are available. If two or more remote clusters have the same name and the name is included in this command, the command fails and it requests the ID of the cluster instead of the name.

Description

This command creates a one-way partnership between the local cluster and the remote cluster that you specify in the command. To create a two-way partnership, the equivalent **svctask mkpartnership** command must be issued from the other cluster.

Intercluster Mirror relationships can be created between primary VDisks in the local cluster and auxiliary VDisks in the remote cluster. Intracluster relationships can be created between VDisks that reside in a local cluster. The VDisks must belong to the same I/O group within the cluster.

Possible failures

- CMMVC5786E The action failed because the cluster is not in a stable state.
- CMMVC5925E The remote cluster partnership was not created because it already exists.

- CMMVC5926E The remote cluster partnership was not created because there are too many partnerships.
- CMMVC5927E The action failed because the cluster ID is not valid.
- CMMVC5928E The action failed because the cluster name specified is a duplicate of another cluster.
- CMMVC6242E The command failed authorization because the session SSH key is wrong or was deleted.
- CMMVC6243E The command failed authorization because the session SSH key does not have the requisite role.

An invocation example

```
svctask mkpartnership -bandwidth 20 cluster1
```

The resulting output

No feedback

mkrcconsistgrp

The **mkrcconsistgrp** command creates a new, empty Metro Mirror or Global Mirror consistency group. If the **-cluster** parameter is not specified, the consistency group is created on the local cluster only.

Syntax

```

>>> svctask -- mkrcconsistgrp -- [ -name new_name_arg ]
|
|
|----->
|
| [ -cluster cluster_id | cluster_name ]
|
|----->>>

```

Parameters

-name *new_name_arg*

(Optional) Specifies a name for the new consistency group.

-cluster *cluster_id* | *cluster_name*

(Optional) Specifies the name or ID of the remote cluster. If **-cluster** is not specified, a consistency group is created only on the local cluster.

Description

This command creates a new consistency group. The ID of the new group is displayed after the command processes. The name must be unique across all consistency groups known to the clusters within this consistency group. If the consistency group involves two clusters, the clusters must be in communication throughout the create process.

The new consistency group does not contain any relationships and will be in the empty state. You can add Metro Mirror or Global Mirror relationships to the group using the **svctask chrelationship** command.

Possible failures

- CMMVC5786E The action failed because the cluster is not in a stable state.

- CMMVC6252E The command failed authorization because the session SSH key is wrong or was deleted.
- CMMVC6253E The command failed authorization because the session SSH key does not have the requisite role.

An invocation example

```
svctask mkrconsistgrp -name rc_testgrp
```

The resulting output

```
RC Consistency Group, id [255], successfully created
```

mkrrelationship

The **mkrrelationship** command creates a new Metro Mirror or Global Mirror relationship with virtual disks (VDisks) in the same cluster (intracluster relationship) or in two different clusters (intercluster relationship).

Syntax

```

▶▶— svctask — — mkrrelationship — — -master ——— master_vdisk_id ———▶
                                     └── master_vdisk_name ───┘

▶ -aux ——— aux_vdisk_id ——— -cluster ——— cluster_id ———▶
          └── aux_vdisk_name ───┘         └── cluster_name ───┘

▶ ——— -name — new_name_id ─—— -consistgrp ——— consist_group_id ———▶
                                     └── consist_group_name ───┘

▶ ——— -sync ─—— -global ─——▶

```

Parameters

-master *master_vdisk_id* | *master_vdisk_name*

(Required) Specifies the ID or name of the master virtual disk.

-aux *aux_vdisk_id* | *aux_vdisk_name*

(Required) Specifies the ID or name of the auxiliary virtual disk.

-cluster *cluster_id* | *cluster_name*

(Required) Specifies the ID or name of the remote cluster.

If you are creating an intracluster relationship, enter the ID of the local cluster. The VDisks in the relationship must belong to the same I/O group within the cluster.

If you are creating an intercluster relationship, enter the ID of the remote cluster. To create a relationship in two different clusters, the clusters must be connected at the time that the **svctask mkrrelationship** command is received.

-name *new_name_id*

(Optional) Specifies a label to assign to the relationship.

-consistgrp *consist_group_id* | *consist_group_name*

(Optional) Specifies a consistency group that this relationship joins. If you do not supply the **-consistgrp** parameter, the relationship is created as a stand-alone relationship that can be started, stopped, and switched on its own.

Note: Metro and Global Mirror relationships cannot belong to the same consistency group. When the first relationship is added to the consistency group, the group takes on the same type as the relationship. Subsequently, only relationships of that type can be added to the consistency group.

-sync

(Optional) Specifies that you want the system to create a synchronized relationship. The **-sync** parameter guarantees that the master and auxiliary disks contain identical data at the point that the relationship is created. You must ensure that the auxiliary disk is created to match the master disk and that no input transactions take place to either disk before you issue the create command. The initial background synchronization is skipped.

-global

(Optional) Specifies that you want the system to create a new Global Mirror relationship. If you do not specify the **-global** parameter, a Metro Mirror relationship is created instead.

Description

This command creates a new Metro Mirror or Global Mirror relationship. A Metro Mirror relationship defines the relationship between two virtual disks (VDisks): a master VDisk and an auxiliary VDisk. This relationship persists until it is deleted. The auxiliary virtual disk must be identical in size to the master virtual disk or the command fails, and if both VDIs are in the same cluster they must both be in the same I/O group. The master and auxiliary cannot be in an existing relationship. Neither disk can be the target of a FlashCopy mapping. This command returns the new relationship (relationship_id) when successful.

Metro Mirror relationships use one of the following copy types:

- A Metro Mirror copy ensures that updates are committed to both the primary and secondary VDIs before sending confirmation of I/O completion to the host application. This ensures that the secondary VDisk is synchronized with the primary VDisk in the event that a failover operation is performed.
- A Global Mirror copy allows the host application to receive confirmation of I/O completion before the updates are committed to the secondary VDisk. If a failover operation is performed, the host application must recover and apply any updates that were not committed to the secondary VDisk.

You can optionally give the relationship a name. The name must be a unique relationship name across both clusters.

The relationship can optionally be assigned to a consistency group. A consistency group ensures that a number of relationships are managed so that, in the event of a disconnection of the relationships, the data in all relationships within the group is in a consistent state. This can be important in, for example, a database application where data files and log files are stored on separate VDIs, and consequently are managed by separate relationships. In the event of a disaster, the primary and secondary sites might become disconnected. If the relationships that are associated with the VDIs are not in a consistency group, then as the disconnection occurs and the relationships stop copying data from the primary to the secondary site, there is no assurance that updates to the two separate secondary VDIs will stop in a consistent manner.

For proper database operation, it is important that updates to the log files and the database data are made in a consistent and orderly fashion. It is crucial in this example that the logfile VDisk and the data VDisk at the secondary site are in a consistent state. This can be achieved by putting the relationships that are associated with these VDdisks into a consistency group. Both Metro Mirror and Global Mirror ensure that updates to both VDdisks at the secondary site are stopped leaving the image consistent based on the updates that happened at the primary site.

If you specify a consistency group, both the group and the relationship must have been created using the same master cluster and the same auxiliary cluster. The relationship must not be a part of another consistency group. If the consistency group is *empty*, it acquires the type of the first relationship that is added to it. Therefore, each subsequent relationship that you add to the consistency group must be of the same type.

If the consistency group is *not empty*, the consistency group and the relationship must be in the same state. If the consistency group is *empty*, it acquires the state of the first relationship that is added to it. If the state has an assigned copy direction, the direction of the consistency group and the relationship must match that direction.

If you do not specify a consistency group, a stand-alone relationship is created.

If you specify the **-sync** parameter, the master and auxiliary virtual disks contain identical data at the point when the relationship is created. You must ensure that the auxiliary is created to match the master and that no data movement occurs to either virtual disk before you issue the **svctask mkrrelationship** command.

If you specify the **-global** parameter, a Global Mirror relationship is created. Otherwise, a Metro Mirror relationship is created instead.

Possible failures

Note: If you receive an error for this command that indicates that the licensed virtualization capacity has been exceeded, then the command was still effective. However, the return code will indicate the license violation.

- CMMVC5786E The action failed because the cluster is not in a stable state.
- CMMVC5930E The Remote Copy relationship was not created because an entity that was specified in the command does not exist.
- CMMVC5931E The Remote Copy relationship was not created because the master or auxiliary virtual disk (VDisk) is locked.
- CMMVC5932E The Remote Copy relationship was not created because the master or auxiliary virtual disk (VDisk) is a member of a FlashCopy mapping.
- CMMVC5933E The Remote Copy relationship was not created because the master or auxiliary virtual disk (VDisk) is in the recovery I/O group.
- CMMVC5934E The specified relationship is not valid.
- CMMVC5965E The virtual disks (VDisks) are in different I/O groups on the local cluster.
- CMMVC6024E The auxiliary VDisk entered is invalid.
- CMMVC6034E The action failed because the maximum number of objects has been reached.

- CMMVC6237E The command failed as the remote cluster does not support global mirror
- CMMVC6252E The command failed authorization because the session SSH key is wrong or was deleted.
- CMMVC6253E The command failed authorization because the session SSH key does not have the requisite role.

An invocation example

```
svctask mkrcrelationship -master vdisk1 -aux vdisk2 -name rccopy1
-cluster 0000020063432AFD
```

The resulting output

```
RC Relationship, id [28], successfully created
```

rmpartnership

The **rmpartnership** command removes a partnership on one cluster. Because the partnership exists on both clusters, it is necessary to run this command on both clusters to remove both sides of the partnership. If the command is run on only one cluster, the partnership enters a partially configured state and Metro Mirror activity ceases as the relationships become disconnected.

Syntax

```
svctask -- rmpartnership -- remote_cluster_id remote_cluster_name
```

Parameters

remote_cluster_id | remote_cluster_name

(Required) Specifies the cluster ID or name of the remote cluster.

Description

This command deletes one half of a partnership on a cluster. You must run this command twice, once on each cluster to remove the whole partnership.

Possible failures

- CMMVC5786E The action failed because the cluster is not in a stable state.
- CMMVC5927E The action failed because the cluster ID is not valid.
- CMMVC5928E The action failed because the cluster name is a duplicate of another cluster.
- CMMVC5929E The Remote Copy partnership was not deleted because it has already been deleted.
- CMMVC6252E The command failed authorization because the session SSH key is wrong or was deleted.
- CMMVC6253E The command failed authorization because the session SSH key does not have the requisite role.

An invocation example

```
svctask rmpartnership cluster1
```

The resulting output

rmrcconsistgrp

The **rmrcconsistgrp** command deletes an existing Metro Mirror or Global Mirror consistency group.

Syntax

```
svctask - - rmrcconsistgrp - [-force] rc_consist_group_id | rc_consist_group_name
```

Parameters

-force

(Optional) Specifies that you want the system to remove all relationships belonging to a group before the consistency group is deleted. The relationships themselves are not deleted; they become stand-alone relationships.

Note: The **-force** parameter must be used to delete a consistency group when the consistency group has any Metro Mirror or Global Mirror relationships that is associated with it. If you do not use the **-force** parameter, the command fails.

rc_consist_group_id | rc_consist_group_name

(Required) Specifies the ID or name of the consistency group to delete.

Description

This command deletes the specified consistency group. You can issue this command for any existing consistency group. If the consistency group is disconnected at the time that the command is issued, the consistency group is only deleted on the cluster that is connected. When the clusters reconnect, the consistency group is automatically deleted on the other cluster. Alternatively, if the clusters are disconnected, and you still want to remove the consistency group on both clusters, you can issue the **svctask rmrcconsistgrp** command separately on both of the clusters.

If the consistency group is not empty, the **-force** parameter is required to delete the group. This removes the relationships from the consistency group before the group is deleted. These relationships become stand-alone relationships. The state of these relationships is not changed by the action of removing them from the consistency group.

Possible failures

- CMMVC5786E The action failed because the cluster is not in a stable state.
- CMMVC5937E The action failed because an entity that was specified in the command does not exist.
- CMMVC5938E The Remote Copy consistency group was not deleted because the consistency group contains relationships. To delete the consistency group, the force option is required.

- CMMVC6252E The command failed authorization because the session SSH key is wrong or was deleted.
- CMMVC6253E The command failed authorization because the session SSH key does not have the requisite role.

An invocation example

```
svctask rmrconsistgrp rctestone
```

The resulting output

```
No feedback
```

rmrrelationship

The **rmrrelationship** command deletes an existing Metro Mirror or Global Mirror relationship.

Syntax

```
svctask -- rmrrelationship -- rc_rel_id | rc_rel_name
```

Parameters

rc_rel_id | rc_rel_name

(Required) Specifies the ID or the name of the relationship. A relationship cannot be deleted if it is part of a consistency group.

Description

This command deletes the relationship that is specified.

Deleting a relationship only deletes the logical relationship between the two virtual disks; it does not affect the virtual disks themselves.

If the relationship is disconnected at the time that the command is issued, the relationship is only deleted on the cluster where the command is being run. When the clusters reconnect, the relationship is automatically deleted on the other cluster. Alternatively, if the clusters are disconnected and if you still want to remove the relationship on both clusters, you can issue the **svctask rmrrelationship** command independently on both of the clusters.

A relationship cannot be deleted if it is part of a consistency group. You must first remove the relationship from the consistency group using the **svctask chrrelationship -force** command.

If you delete an inconsistent relationship, the secondary virtual disk becomes accessible even though it is still inconsistent. This is the one case in which Metro or Global Mirror does not inhibit access to inconsistent data.

Possible failures

- CMMVC5786E The action failed because the cluster is not in a stable state.
- CMMVC5935E The action failed because an entity that was specified in the command does not exist.

- CMMVC6252E The command failed authorization because the session SSH key is wrong or was deleted.
- CMMVC6253E The command failed authorization because the session SSH key does not have the requisite role.

An invocation example

```
svctask rmrrelationship rccopy1
```

The resulting output

```
No feedback
```

startrcconsistgrp

The **startrcconsistgrp** command starts the Metro Mirror or Global Mirror consistency group copy process, sets the direction of copy if undefined, and optionally marks the secondary VDisks of the consistency group as clean.

Syntax

```

▶▶ svctask — — startrcconsistgrp — [ -primary [ master | aux ] ] [ -force ] [ -clean ] [ rc_consist_group_id | rc_consist_group_name ]

```

Parameters

-primary *master* | *aux*

(Optional) Specifies the copy direction by defining whether the master or auxiliary disk becomes the primary (source). This parameter is required when the primary is undefined, for example if the consistency group is in the idling state.

-force

(Optional) Specifies that you want the system to process the copy operation even if it might lead to a temporary loss of consistency while synchronization occurs. This parameter is required if the consistency group is in a state of ConsistentStopped but not synchronized, or Idling but not synchronized.

-clean

(Optional) Specifies that the VDisk which is to become a secondary, is clean for each of the relationships belonging to the group. The consistency group must be in an Idling (connected) state for this parameter to work.

rc_consist_group_id | **rc_consist_group_name**

(Required) Specifies the ID or name of the consistency group to start.

Description

This command starts a Metro Mirror or Global Mirror stand-alone consistency group.

This command can only be issued to a consistency group that is connected. For a consistency group that is idling, this command assigns a copy direction (primary

and secondary roles) and begins the copy process. Otherwise, this command restarts a previous copy process that was stopped either by a stop command or by some I/O error.

If the resumption of the copy process leads to a period when the relationship is not consistent, then you must specify the **-force** parameter when restarting the relationship. This situation could arise if, say, the relationship had been stopped, and then further input transactions had been performed on the original primary disk of the relationship. When you use the **-force** parameter in this situation, the data on the secondary disk is not usable (because it is inconsistent) in a disaster recovery circumstance.

In the idling state, you must provide the **-primary** parameter. In other connected states, you can provide the **-primary** parameter, but it must match the existing setting.

The **-force** flag is required if consistency would be lost by starting a copy operation. This would occur, if write operations on either primary or secondary vdisks have taken place since the ConsistentStopped or idling state was entered. If the command is issued without the **-force** flag in such circumstances, the command will fail. In general, the **-force** flag will be required if the group is in one of the following states:

- Consistent_Stopped but not synchronized (sync=out_of_sync)
- Idling but not synchronized

The **-force** flag is not required if the group is in one of the following states:

- Inconsistent_Stopped
- Inconsistent_Copying
- Consistent_Synchronized

However, the command will not fail if you do specify the **-force** flag.

The **-clean** parameter is used when a Metro Mirror or Global Mirror group is started and the secondary VDisks in this group are assumed to be clean. Clean in this sense, means that any changes that have been made at the secondary are ignored and only changes made at the primary are considered when synchronizing the primary and secondary disks. This **-clean** parameter can be used in the following scenario:

1. A consistency group is created with the **-synch** parameter. At this point it does not matter if the primary and secondary contain the same data, even though the use of the **-synch** parameter implies that this is true.
2. A **stoprconsistgrp** command is issued with the **-access** parameter. This permits access to the secondary disk. Change recording begins at the primary.
3. An image of the primary disk is copied and loaded on to the secondary disk. It is permissible to allow updates to the primary disk during the image copy as this image need only be a *fuzzy* image of the primary disk.
4. A **startcconsistgrp** command that specifies the **-primary master**, **-force**, and **-clean** parameters is issued. The auxiliary disk is marked as clean and changes on the master disk that have occurred since the relationship was stopped are copied to the auxiliary disk.
5. Once the background copy has completed, relationships in the group become consistent and synchronized.

Possible failures

- CMMVC5786E The action failed because the cluster is not in a stable state.
- CMMVC5936E The action failed because an entity that was specified in the command does not exist.
- CMMVC6252E The command failed authorization because the session SSH key is wrong or was deleted.
- CMMVC6253E The command failed authorization because the session SSH key does not have the requisite role.

An invocation example

```
svctask starttrconsistgrp rccopy1
```

The resulting output

```
No feedback
```

startrelationship

The **startrelationship** command starts the Metro Mirror or Global Mirror relationship copy process, sets the direction of copy if undefined, and optionally marks the secondary VDisk of the relationship as clean. The relationship must be a stand-alone relationship.

Syntax

```
svctask -- startrelationship -- [-primary master | aux] [-force] [-clean] rc_rel_id rc_rel_name
```

Parameters

-primary *master* | *aux*

(Optional) Specifies the copy direction by defining whether the master or auxiliary disk becomes the primary (source). This parameter is required when the primary is undefined, for example if the relationship is in the idling state.

-force

(Optional) Specifies that you want the system to process the copy operation even if it might lead to a temporary loss of consistency while synchronization occurs. This parameter is required if the relationship is in a state of ConsistentStopped but not synchronized, or Idling but not synchronized.

-clean

(Optional) Specifies that the VDisk which is to become a secondary, is clean. The relationship must be in an Idling (connected) state for this parameter to work.

rc_rel_id | **rc_rel_name**

(Required) Specifies the ID or name of the relationship that you want to start in a stand-alone relationship only.

Description

This command is used to start a stand-alone relationship. The command fails if it is used to start a relationship that is part of a consistency group.

This command can only be issued to a relationship that is connected. For a relationship that is idling, this command assigns a copy direction (primary and secondary roles) and begins the copy process. Otherwise, this command restarts a previous copy process that was stopped either by a stop command or by some I/O error.

If the resumption of the copy process will lead to a period when the relationship is not consistent, you must specify the **-force** parameter when restarting the relationship. This situation could arise if the relationship had been stopped, and then further input transactions had occurred on the original primary of the relationship. Even though you use of the **-force** parameter in this situation, the data on the secondary is not be useful for disaster recovery purposes because the relationship is in an inconsistent state.

In the idling state, you must provide the **-primary** parameter. In other connected states, you can provide the **-primary** parameter, but it must match the existing setting.

The **-force** parameter is required if consistency would be lost by starting a copy operation. This would occur, if input transactions have occurred on either the primary or secondary VDisks since the ConsistentStopped or idling state was entered. If the **startcrelationship** command is issued without the **-force** parameter in such circumstances, the command fails. In general, the **-force** parameter is required if the relationship is in one of the following states:

- ConsistentStopped but not synchronized
- Idling but not synchronized

The **-force** parameter is not required if the relationship is in one of the following states:

- InconsistentStopped
- InconsistentCopying
- ConsistentSynchronized

However, the command will not fail if you do specify the **-force** parameter.

The **-clean** parameter is used when a Metro Mirror or Global Mirror relationship is started and the secondary VDisk in the relationship is assumed to be clean. Clean in this sense, means that any changes that have been made at the secondary are ignored and only changes made at the primary are considered when synchronizing the primary and secondary disks. The **-clean** parameter can be used in the following circumstance:

1. A relationship is created with the **-synch** parameter specified. (At this point it does not matter if the primary and secondary disks contain the same data, even though the use of the **-synch** parameter implies that this is true).
2. A **svctask stopcrelationship** command is issued with the **-access** parameter specified. This permits access to the secondary disk. Change recording begins at the primary disk.
3. An image of the primary disk is copied and loaded on to the secondary disk. It is permissible to allow updates to the primary disk during the image copy as this image need only be a *fuzzy* image of the primary disk.

4. A `svctask starttrrelationship` command that specifies the `-primary master`, `-force`, and `-clean` parameters is issued. The auxiliary disk is marked as clean and changes on the master disk that have occurred since the relationship was stopped are copied to the auxiliary disk.
5. Once the background copy has completed, the relationship becomes consistent and synchronized.

Possible failures

- CMMVC5786E The action failed because the cluster is not in a stable state.
- CMMVC5936E The action failed because an entity that was specified in the command does not exist.
- CMMVC6252E The command failed authorization because the session SSH key is wrong or was deleted.
- CMMVC6253E The command failed authorization because the session SSH key does not have the requisite role.

An invocation example

```
svctask starttrrelationship rccopy1
```

The resulting output

```
No feedback
```

stoprconsistgrp

The `stoprconsistgrp` command stops the copy process for a Metro Mirror or Global Mirror consistency group. This command can also be used to enable write access to the secondary VDisks in the group if the group is in a consistent state.

Syntax

```
▶▶ svctask — — stoprconsistgrp — [ -access ] —————▶▶  
  
▶ [ rc_consist_group_id | rc_consist_group_name ] —————▶▶
```

Parameters

`-access`

(Optional) Specifies That you want the system to allow write access to consistent secondary VDisks in the consistency group.

`rc_consist_group_id` | `rc_consist_group_name`

(Required) Specifies the ID or name of the consistency group where you want the system to stop all processing.

Description

This command applies to a consistency group. You can issue this command to stop processing on a consistency group that is copying from primary VDisks to secondary VDisks.

If the consistency group is in an inconsistent state, any copy operation stops and does not resume until you issue the **svctask startprconsistgrp** command. For a consistency group in the ConsistentSynchronized state, this command causes a consistency freeze.

When a consistency group is in a consistent state (for example, in the ConsistentStopped, ConsistentSynchronized, or ConsistentDisconnected state) you can issue the **-access** parameter with the **stopprconsistgrp** command to enable write access to the secondary virtual disks within that group.

Initial state	Final state	Notes
InconsistentStopped	InconsistentStopped	-
InconsistentCopying	InconsistentStopped	-
ConsistentStopped	ConsistentStopped	-access permitted
ConsistentSynchronized	ConsistentStopped	-access permitted
Idling	ConsistentStopped	-access permitted
IdlingDisconnected	unchanged	A relationship may move to stopped state when reconnected.
InconsistentDisconnected	InconsistentStopped	On the cluster issuing the svctask stopprconsistgrp command.
InconsistentDisconnected	unchanged	On the disconnected cluster.
ConsistentDisconnected	ConsistentStopped	On the cluster issuing the svctask stopprconsistgrp command, -access permitted.
ConsistentDisconnected	unchanged	On the disconnected cluster, -access permitted.

Possible failures

- CMMVC5786E The action failed because the cluster is not in a stable state.
- CMMVC5936E The action failed because an entity that was specified in the command does not exist.
- CMMVC6252E The command failed authorization because the session SSH key is wrong or was deleted.
- CMMVC6253E The command failed authorization because the session SSH key does not have the requisite role.

An invocation example

```
svctask stopprconsistgrp rccopy1
```

The resulting output

```
No feedback
```

stopprrelationship

The **stopprrelationship** command stops the copy process for a Metro Mirror or Global Mirror stand-alone relationship. You can also use this command to enable write access to a consistent secondary VDisk.

Syntax

```
svctask -- stopprrelationship [-access] rc_rel_id rc_rel_name
```

Parameters

-access

(Optional) Specifies that the system allow write access to a consistent secondary VDisk.

rc_rel_id | rc_rel_name

(Required) Specifies the ID or name of the relationship that you want the system to stop all processing.

Description

This command applies to a stand-alone relationship. The command is rejected if it is addressed to a relationship that is part of a consistency group. You can issue this command to stop a relationship that is copying from primary to secondary.

If the relationship is in an inconsistent state, any copy operation stops and does not resume until you issue a **svctask startrelationship** command. For a relationship in the ConsistentSynchronized state, this command causes a consistency freeze.

When a relationship is in a consistent state (ie, in the ConsistentStopped, ConsistentSynchronized, or ConsistentDisconnected state) then you can use the **-access** parameter to enable write access to the secondary virtual disk.

Initial state	Final state	Notes
InconsistentStopped	InconsistentStopped	-
InconsistentCopying	InconsistentStopped	-
ConsistentStopped	ConsistentStopped	-access permitted
ConsistentSynchronized	ConsistentStopped	-access permitted
Idling	ConsistentStopped	-access permitted
IdlingDisconnected	unchanged	A relationship can move to the stopped state when reconnected.
InconsistentDisconnected	InconsistentStopped	On the cluster issuing the svctask stopprrelationship command.
InconsistentDisconnected	unchanged	On the disconnected cluster.
ConsistentDisconnected	ConsistentStopped	On the cluster issuing the svctask stopprrelationship command, -access permitted.
ConsistentDisconnected	unchanged	On the disconnected cluster, -access permitted.

Possible failures

- CMMVC5786E The action failed because the cluster is not in a stable state.

- CMMVC5936E The action failed because an entity that was specified in the command does not exist.
- CMMVC6252E The command failed authorization because the session SSH key is wrong or was deleted.
- CMMVC6253E The command failed authorization because the session SSH key does not have the requisite role.

An invocation example

```
svctask stopprrelationship rccopy1
```

The resulting output

No feedback

switchrconsistgrp

The **switchrconsistgrp** command reverses the roles of the primary and secondary virtual disks in a Metro Mirror or Global Mirror consistency group when that consistency group is in a consistent state. All the relationships in the consistency group are affected by this change.

Syntax

```
svctask -- switchrconsistgrp -- -primary [ master | aux ]
rc_consist_group_id | rc_consist_group_name
```

Parameters

-primary *master* | *aux*

(Required) Specifies whether the master or auxiliary side of the relationships in the group will become the primary VDisks.

rc_consist_group_id | **rc_consist_group_name**

(Required) Specifies the ID or name of the consistency group to switch.

Description

This command applies to a consistency group. It is normally issued to reverse the roles of the primary and secondary virtual disks in a consistency group, perhaps as part of a failover process associated with a disaster recovery event. Write access to the former primary VDisks is lost and write access to the new primary VDisks is acquired. This command is successful when the consistency group is in a connected, consistent state, and when reversing the direction of the relationships would not lead to a loss of consistency, for example, when the consistency group is consistent and synchronized. The consistency group must be in one of the following states in order for the **switchrconsistgrp** command to process correctly:

- ConsistentSynchronized
- ConsistentStopped and Synchronized
- Idling and Synchronized

The consistency group moves to the ConsistentSynchronized state after the successful completion of this command. If you specify the **-primary** parameter and it is the same as the current primary, the command has no affect.

Possible failures

- CMMVC5786E The action failed because the cluster is not in a stable state.
- CMMVC5936E The action failed because an entity that was specified in the command does not exist.
- CMMVC6252E The command failed authorization because the session SSH key is wrong or was deleted.
- CMMVC6253E The command failed authorization because the session SSH key does not have the requisite role.

An invocation example

```
svctask switchrconsistgrp -primary aux rccopy2
```

The resulting output

```
No feedback
```

switchrrelationship

The **switchrrelationship** command reverses the roles of primary and secondary virtual disks in a stand-alone Metro Mirror or Global Mirror relationship when that relationship is in a consistent state.

Syntax

```
svctask -- switchrrelationship -- -primary [ master | aux ]
rc_rel_id | rc_rel_name
```

Parameters

-primary *master* | *aux*

(Required) Specifies whether the master disk or the auxiliary disk is to be the primary.

rc_rel_id | **rc_rel_name**

(Required) Specifies the ID or name of the relationship to switch.

Description

This command applies to a stand-alone relationship. It is rejected if it is used to try to switch a relationship that is part of a consistency group. It is normally issued to reverse the roles of the primary and secondary virtual disk in a relationship perhaps as part of a failover process during a disaster recovery event. Write access to the old primary disk is lost and write access to the new primary disk is acquired. This command is successful when the relationship is in a connected, consistent state, and when reversing the direction of the relationship does not lead to a loss of consistency; that is, when the relationship is consistent and synchronized. The relationship must be in one of the following states in order for the **switchrrelationship** command to process correctly:

- ConsistentSynchronized
- ConsistentStopped and Synchronized
- Idling and Synchronized

| The relationship moves to the ConsistentSynchronized state after the successful
| completion of this command. If you specify the **-primary** parameter with the
| current primary, the command has no effect.

Possible failures

- CMMVC5786E The action failed because the cluster is not in a stable state.
- CMMVC5936E The action failed because an entity that was specified in the command does not exist.
- CMMVC6252E The command failed authorization because the session SSH key is wrong or was deleted.
- CMMVC6253E The command failed authorization because the session SSH key does not have the requisite role.

An invocation example

| `svctask switchcrelationship -primary master rccopy2`

The resulting output

| No feedback

Chapter 16. Migration commands

The following commands enable you to work with migration options with the SAN Volume Controller.

migrateexts

The **migrateexts** command enables you to migrate a number of extents from a given managed disk to another.

Syntax

```
| ▶ svctask - - migrateexts - - -source [ source_mdisk_id | source_mdisk_name ] - - -
|
| ▶ -target [ target_mdisk_id | target_mdisk_name ] - - -exts number_of_extents - - -
|
| ▶ [ -threads number_of_threads ] - - -vdisk [ vdisk_id | vdisk_name ] - - -
|
```

Parameters

- source *source_mdisk_id | source_mdisk_name*
(Required) Specifies the MDisk on which the extents currently reside.
- target *target_mdisk_id | target_mdisk_name*
(Required) Specifies the MDisk onto which the extents are to be migrated.
- exts *number_of_extents*
(Required) Specifies the number of extents to migrate.
- threads *number_of_threads*
(Optional) Specifies the number of threads to use while migrating these extents. You can specify 1 - 4 threads. The default number of threads is 4.
- vdisk *vdisk_id | vdisk_name*
(Required) Specifies the VDisk to which the extents belong.

Description

This command migrates a given number of extents from the source, specified in terms of the virtual disk, and the managed disk that contains some extents used to make up the virtual disk. The target is specified in terms of a managed disk (within the same managed disk group).

If a large number of extents are being migrated, you can specify the number of threads that should be started, between one and four. The progress of these can be checked by issuing the **svcinfo lsmigrate** command.

The **svctask migrateexts** command fails if there are insufficient free extents on the target managed disk. To avoid this problem, do not issue new commands that use extents until the extents migration is completed.

Note: Migration activity on a single managed disk is limited to a maximum of 4 concurrent operations. This limit does not take into account whether the managed disk is the source or the destination. If more than four migrations are scheduled for a particular managed disk, further migration operations are queued pending the completion of one of the currently running migrations. If a migration operation is stopped for any reason, a queued migration task could be started. If however a migration is suspended, the current migration continues to use resources and a pending migration is not started. For example, the following setup is a possible initial configuration:

- MDiskGrp 1 has VDisk 1 created in it
- MDiskGrp 2 has VDisk 2 created in it
- MDiskGrp 3 has only one MDisk

With the configuration above, the following migrate operations are started:

- Migrate 1 migrates VDisk 1 from MDiskGrp 1 to MDiskGrp 3, running with 4 threads.
- Migrate 2 migrates VDisk 2 from MDiskGrp 2 to MDiskGrp 3, running with 4 threads.

Due to the limitations described above, the two migration operations do not always run at the same speed. MDiskGrp 3 has only one MDisk and the two migration operations have a total of 8 threads trying to access the one MDisk. Four threads are active. The remaining threads are in standby mode waiting for the chance to access the MDisk.

Possible failures

- CMMVC5786 The action failed because the cluster is not in stable state.
- CMMVC5845 The extent was not migrated because an object that was specified in the command does not exist.
- CMMVC5849E The migration failed because some or all of the extents are already being migrated.
- CMMVC5850E The extent was not migrated because there is a problem with the source extents.
- CMMVC5851E The extent was not migrated because there is a problem with the target extents.
- CMMVC5852E The migration failed because there are too many migrations in progress.
- CMMVC5859E The migration did not complete because an error occurred while migrating the last extent on an image-mode virtual disk (VDisk).
- CMMVC5863E The migration failed because there are not enough free extents on the target managed disk (MDisk).
- CMMVC5865E The extent specified is out of range for the mdisk or vdisk specified
- CMMVC5866E The extent was not migrated because the extent contains internal data.
- CMMVC6252E The command failed authorization because the session SSH key is wrong or was deleted.
- CMMVC6253E The command failed authorization because the session SSH key does not have the requisite role.

An invocation example

```
svctask migrateexts -vdisk vdisk4 -source mdisk4 -exts
64 -target mdisk6 -threads 4
```

The resulting output

No feedback

migratetoimage

The **migratetoimage** command enables you to migrate the data of the user-specified source virtual disk (either image mode or managed mode) onto the specified unmanaged disk to create an image mode VDisk. The target disk can be in the same or in a different managed disk (MDisk) group to the source disk.

Syntax

```
►► svctask — migratetoimage — -vdisk ————┐ source_vdisk_id ───►
                                           └─ source_vdisk_name ─┘

└── -threads — number_of_threads ───►

► -mdisk ───┐ unmanaged_target_mdisk_id ───►
             └─ unmanaged_target_mdisk_name ─┘

► -mdiskgrp ───┐ managed_disk_group_id ───►
                └─ managed_disk_group_name ─┘
```

Parameters

-vdisk *source_vdisk_id* | *name*

(Required) Specifies the name or ID of the source VDisk to be migrated.

-threads *number_of_threads*

(Optional) Specifies the number of threads to use while migrating these extents. You can specify 1 - 4 threads. The default number of threads is 4.

-mdisk *unmanaged_target_mdisk_id* | *name*

(Required) Specifies the name of the MDisk to which the data must be migrated. This disk must be unmanaged and large enough to contain the data of the disk being migrated.

-mdiskgrp *managed_disk_group_id* | *name*

(Required) Specifies the MDisk group into which the MDisk must be placed, after the migration has completed.

Description

This command migrates the data of the user-specified source virtual disk onto the managed disk specified as the target. At completion of the command, the virtual disk is classified as an image mode disk.

The managed disk specified as the target must be in an unmanaged state at the time the command is run. Processing this command results in the inclusion of the MDisk into the user-specified MDisk group.

Possible failures

Note: If you receive an error for this command that indicates that the licensed virtualization capacity has been exceeded, then the command was still effective. However, the return code indicates the license violation.

- CMMVC5786E The action failed because the cluster is not in a stable state.
- CMMVC5842E The action failed because an entity that was specified in the command does not exist.
- CMMVC5874E The action failed because the host does not exist.
- CMMVC5875E The action failed because the virtual disk (VDisk) does not exist.
- CMMVC6252E The command failed authorization because the session SSH key is wrong or was deleted.
- CMMVC6253E The command failed authorization because the session SSH key does not have the requisite role.

The example below specifies that the user wants to migrate the data from vdisk1 onto mdisk5 and the MDisk must be put into the MDisk group mdgrp2.

An invocation example

```
svctask migratetoimage -vdisk vdisk1 -mdisk mdisk5 -mdiskgrp mdgrp2
```

The resulting output

No feedback

migratevdisk

The **migratevdisk** command enables you to migrate an entire virtual disk from one managed disk group to another managed disk group.

Syntax

```
svctask -- migratevdisk -- -mdiskgrp [mdisk_group_id | mdisk_group_name]
-- -threads [number_of_threads] -- -vdisk [vdisk_id | vdisk_name]
```

Parameters

-mdiskgrp *mdisk_group_id* | *mdisk_group_name*

(Required) Specifies the new managed disk group ID or name.

-threads *number_of_threads*

(Optional) Specifies the number of threads to use while migrating these extents. You can specify 1 - 4 threads. The default number of threads is 4.

-vdisk *vdisk_id* | *vdisk_name*

(Required) Specifies the virtual disk ID or name to migrate in to a new managed disk group.

Description

This command migrates the specified virtual disk into a new managed disk group. That is, all the extents that make up the virtual disk are migrated onto free extents in the new managed disk group.

The command returns a success message while the transfer completes in the background. The command returns with the `in_progress` return code. The progress of the migration can be found by issuing the `svcinfo lsmigrate` command, which lists the migrations in progress.

The process can be prioritized by specifying the number of threads to use while migrating. Using only one thread puts the least background load on the system.

The `migratevdisk` command fails if there are insufficient free extents on the targeted managed disk group for the duration of the command. To avoid this problem, do not issue new commands that use extents until the vdisk migration is completed.

Possible failures

- CMMVC5786E The action failed because the cluster is not in a stable state.
- CMMVC5846E The virtual disk (VDisk) was not migrated because an entity that was specified in the command does not exist.
- CMMVC5847E The virtual disk (VDisk) was not migrated because its associated managed disk (MDisk) is already in the MDisk group.
- CMMVC5849E The migration failed because some or all of the extents are already being migrated.
- CMMVC5852E The migration failed because there are too many migrations in progress.
- CMMVC5853E The action failed because there was a problem with the MDisk group.
- CMMVC5861E The action failed because there were not enough extents on the managed disk (MDisk).
- CMMVC5863E The migration failed because there are not enough free extents on the target managed disk (MDisk).
- CMMVC6252E The command failed authorization because the session SSH key is wrong or was deleted.
- CMMVC6253E The command failed authorization because the session SSH key does not have the requisite role.

An invocation example

```
svctask migratevdisk -vdisk 4 -mdiskgrp Group0 -threads 2
```

The resulting output

No feedback

Chapter 17. Tracing commands

The following commands enable you to work with tracing options with the SAN Volume Controller.

setdisktrace

Use the **setdisktrace** command to set a list of disks of a given type, to include in a disk trace.

Syntax

```
svctask -- setdisktrace -- -type [ mdisk | vdisk ] [ -set | -reset ]
[ -all | -objectid id_or_name_list ]
```

Parameters

-type *mdisk* | *vdisk*

Specifies the object type for the disks.

-set

Specifies the set argument. The **-set** and **-reset** arguments are mutually exclusive.

-reset

Specifies the reset argument. The **-set** and **-reset** arguments are mutually exclusive.

-all

Specifies that you want to trace all disks of the given type. The **-objectid** and **-all** arguments are mutually exclusive.

-objectid *id_or_name_list*

Specifies a list of one or more disk IDs or names. The **-objectid** and **-all** arguments are mutually exclusive.

Description

This command marks a list of one, more, or all disks of the given type such that these disks will participate in the next triggered trace.

This is used in conjunction with the **svctask settrace** command which sets the options that result in a trace file being generated and the data that is included in the trace file.

Possible failures

- CMMVC5786E The action failed because the cluster is not in a stable state.

An invocation example

```
svctask setdisktrace -type mdisk -objectid
mdisk1:mdisk3:mdisk11:mdisk10:mdisk9:mdisk5 -reset
```

The resulting output

No feedback

settrace

Use the **settrace** command to set options to trace certain I/O operations through the system.

Syntax

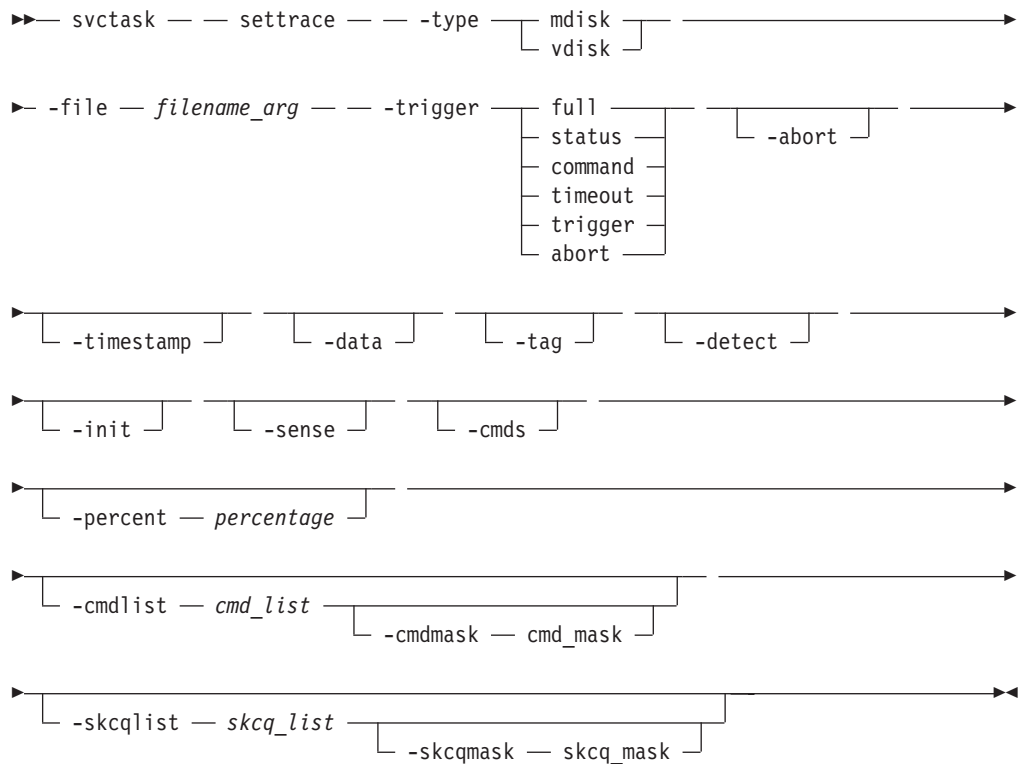

Parameters

-type *mdisk* | *vdisk*

Specifies the type of objects to trace.

-file *filename_arg*

Specifies the file name prefix for the trace file.

-trigger *full* | *status* | *command* | *timeout* | *trigger* | *abort*

Specifies the trigger option, that is, what to do when the trace is started (triggered).

full When the trace buffer is full, stop the trace (valid for both MDisks and VDIsks).

status When the given SCSI status (*-skcqlist*) is reported in sense data (valid for both MDisks and VDIsks).

command

When the given SCSI command (*-cmdlist*) is sent (valid for both MDisks and VDIsks).

- timeout** When a timeout occurs (only valid for MDisks).
- trigger** Keep running until the trigger event, that is, wrap (only valid for MDisks).
- abort** When an abort occurs (only valid for VDIs).
- abort** Optionally specifies the abort argument, which adds the abort details to the trace. This argument is only valid for VDIs.
- timestamp** Optionally specifies the time-stamp flag. Adds a time-stamp to each entry in the trace. A file name is created from the prefix plus a time-stamp. The file name is in the form <prefix>_AAAAAA_YYMMDD_HHMMSS, where AAAAAA is the panel name of the node generating the trace file.
- data** Optionally specifies the data flag, which adds the I/O data to the trace.
- tag** Optionally specifies the ccb_tags flag. Adds the CCB tags to the trace. This argument is for valid for MDisks.
- detect** Optionally specifies the discovery flag. Adds the MDisk discovery details to the trace for MDisks.
- init** Optionally specifies the initialization flag, which adds the MDisk initialization details to the trace for MDisks.
- sense** Optionally specifies the sense flag, which adds the SCSI sense data to the trace. This flag is only valid for VDIs.
- cmds** Optionally specifies the commands flag, which adds the commands data to the trace. This flag is only valid for VDIs only.
- percent** Optionally specifies where in the trace file the chosen trigger point should occur. That is, this flag specifies how much data to gather after the trigger point. The default is 50%, so the trigger point would be in the middle of the trace file.
- cmdlist** *cmd_list* Optionally specifies a command list, which adds only those commands to the trace file.
- cmdmask** *cmd_mask* Optionally specifies a command mask, which adds only those commands to the trace file. This can only be entered if the -cmdlist argument has been entered.
- skcqlist** *skcq_list* Optionally specifies a SKCQ list, which adds only those SKCQ details to the trace file.

-skcqmask *skcq_mask*

Optionally specifies a SKCQ mask, which adds only those SKCQ details to the trace file. This can only be entered if the **-skcqlist** argument has been entered.

Description

This command sets the various I/O tracing options you want for a particular disk type, that is managed disks or virtual disks. When the relevant disk type trace is subsequently triggered, the options specify the data you want to include in the trace file.

The file name specifies a file name prefix to use when generating the trace file. The system appends the node panel name and a timestamp to the file name.

A maximum of 10 trace files will be kept on the cluster. When the eleventh trace is made, the oldest existing trace file is overwritten.

The directory may also hold files retrieved from other nodes. These files are not counted. The cluster will delete the oldest file, when necessary, to maintain the maximum number of files.

Possible failures

- CMMVC5786E The action failed because the cluster is not in a stable state.
- CMMVC6073E The maximum number of files has been exceeded.

An invocation example

```
svctask settrace -type vdisk -file tracedump -trigger abort  
-percent 100 -abort -timestamp
```

The resulting output

No feedback

starttrace

Use the **starttrace** command to start tracing I/O operations based on the option currently set for the given object type and the list of disks to trace.

Syntax

```
▶▶— svctask — — starttrace — — -type ————▶▶  
└── mdisk ───┘  
└── vdisk ───┘
```

Parameters

-type *mdisk* | *vdisk*

Specifies the object type to trigger.

Description

This command starts the collection of I/O tracing information. The trace file is generated according to the options that you specified in the **svctask settrace** command. The disks that will be traced are those identified in the list set by the **svctask setdisktrace** command.

The traces are written to the `/dumps/iotrace` directory. The contents of this directory can be viewed using the `svcinfo lsio tracedumps` command.

Possible failures

- CMMVC5786E The action failed because the cluster is not in a stable state.
- CMMVC5809E The tracing of I/O operations was not started because it is already in progress.
- CMMVC5986E The tracing of I/O operations was not started because the virtual disk (VDisk) or managed disk (MDisk) failed to return statistics.

An invocation example

```
svctask starttrace -type vdisk
```

The resulting output

No feedback

stoptrace

Use the `stoptrace` command to stop the tracing for the given disk type.

Syntax

```
svctask -- stoptrace -- -type [ mdisk | vdisk ]
```

Parameters

`-type` *mdisk* | *vdisk*

Specifies the object type to stop tracing.

Description

This command stops the tracing of I/O operations for the given object type. When you issue the `svctask stoptrace` command, you might not get a trace file if the trigger options have not been met.

Possible failures

- CMMVC5786E The action failed because the cluster is not in a stable state.

An invocation example

```
svctask stoptrace -type mdisk
```

The resulting output

No feedback

Chapter 18. Attributes of the -filtervalue argument

The **-filtervalue** argument is used to filter a view based on specific attribute values that relate to each object type. You can combine multiple filters to create specific searches, for example, `-filtervalue name=fred:status=online`. The help (`-filtervalue?`) specifies the attributes available for each object type.

The `-filtervalue` argument, if used, must have `attrib=value` entered. The `-filtervalue?` and `-filtervalue` arguments are mutually exclusive.

Note: The qualifiers `<` and `>` should be enclosed in quotes. For example,

```
-filtervalue vdisk_count "<"4 or port_count ">"1
```

It is also valid to include the whole expression in quotes. For example,

```
-filtervalue "vdisk_count<4"
```

When an attribute requires the `-unit` argument, it is specified after the attribute. For example,

```
-filtervalue capacity=24 -unit mb
```

The valid input options for the `-unit` parameter are:

- b (bytes)
- mb (Megabytes)
- gb (Gigabytes)
- tb (Terabytes)
- pb (Petabytes)

Table 1 provides a list of valid filter attributes, as well as descriptions, qualifiers and wildcards for each object type.

The `*` character may be used as a wildcard at the beginning or end of a text string, but not both.

Table 1. Valid filter attributes

Object	Attribute	Valid Qualifiers	Wildcard Valid	Description
cluster	cluster_name or name	=	Yes	The cluster name.
	cluster_unique_id or id	=, <, <=, >, >=	No	The cluster ID.

Table 1. Valid filter attributes (continued)

Object	Attribute	Valid Qualifiers	Wildcard Valid	Description
node	node_name or name	=	Yes	The node name.
	id	=, <, <=, >, >=	No	The node ID.
	status	=	No	The status of the node. The valid input options for node status are: <ul style="list-style-type: none"> • adding • deleting • online • offline • pending
	IO_group_name	=	Yes	The I/O group name.
	IO_group_id	=, <, <=, >, >=	No	The I/O group ID.
	hardware	=	No	The hardware type with valid entries are 4F2, 8F2, and 8F4.
io_grp	HWS_name or name	=	Yes	The I/O group name
	HWS_unique_id or id	=, <, <=, >, >=	No	The I/O group ID.
	node_count	=, <, <=, >, >=	No	The number of nodes in the I/O group.
	host_count	=, <, <=, >, >=	No	The number of hosts associated with the io_grp.
controller	controller_id or id	=, <, <=, >, >=	No	The controller ID.
mdisk	name	=	Yes	The name of the MDisk.
	id	=, <, <=, >, >=	No	The ID of the MDisk.
	controller_name	=	Yes	The name of the controller the MDisk belongs to.
	status	=	No	The status of the MDisk. The valid input options for MDisk status are: <ul style="list-style-type: none"> • online • degraded • excluded • offline
	mode	=	No	The mode of the MDisk. The valid input options for MDisk mode are: <ul style="list-style-type: none"> • unmanaged • managed • image
	mdisk_grp_name	=	Yes	The MDisk group name.
	mdisk_grp_id	=, <, <=, >, >=	No	The MDisk group ID.
	capacity	=, <, <=, >, >=	No	The capacity. Requires the -unit argument.

Table 1. Valid filter attributes (continued)

Object	Attribute	Valid Qualifiers	Wildcard Valid	Description
mdiskgrp	name	=	Yes	The MDisk group name.
	storage_pool_id or id	=, <, <=, >, >=	No	The MDisk group ID.
	mdisk_count	=, <, <=, >, >=	No	The number of MDisks in the group.
	vdisk_count	=, <, <=, >, >=	No	The number of VDIsks in the group.
	status	=	No	The status of the MDisk group. The valid input options are: <ul style="list-style-type: none"> • online • degraded • offline
	extent_size	=, <, <=, >, >=	No	The extent size. (MB)
vdisk	vdisk_name or name	=	Yes	The name of the VDisk.
	vdisk_id or id	=, <, <=, >, >=	No	The ID of the VDisk.
	IO_group_name	=	Yes	The name of the I/O group.
	IO_group_id	=, <, <=, >, >=	No	The ID of the I/O group.
	status	=	No	The status of the VDisk. <p>The valid input options for VDisk status are:</p> <ul style="list-style-type: none"> • online • degraded • offline
	mdisk_grp_name	=	Yes	The MDisk group name.
	mdisk_grp_id	=, <, <=, >, >=	No	The MDisk group ID.
	capacity	=, <, <=, >, >=	No	The capacity. Requires the -unit argument.
	type	=	No	The VDisk type. The valid value options are: <ul style="list-style-type: none"> • seq • striped • image
	FC_name	=	Yes	The FlashCopy mapping name.
	FC_id	=, <, <=, >, >=	No	The FlashCopy mapping ID.
	RC_name	=	Yes	The Metro Mirror relationship name.
	RC_id	=, <, <=, >, >=	No	The Metro Mirror relationship ID.
host	host_name or name	=	Yes	The host name.
	host_id or id	=, <, <=, >, >=	No	The host ID.
	port_count	=, <, <=, >, >=	No	The number of ports.
	iogrp_count	=, <, <=, >, >=	No	The number of I/O groups associated with the host.

Table 1. Valid filter attributes (continued)

Object	Attribute	Valid Qualifiers	Wildcard Valid	Description
fcmap	FC_mapping_name or name	=	Yes	The FlashCopy mapping name.
	FC_id or id	=, <, <=, >, >=	No	The FlashCopy mapping ID.
	source_vdisk_name	=	Yes	The source VDisk name.
	source_vdisk_id	=, <, <=, >, >=	No	The source VDisk ID.
	target_vdisk_name	=	Yes	The target VDisk name.
	target_vdisk_id	=, <, <=, >, >=	No	The target VDisk ID.
	group_name	=	Yes	The consistency group name.
	group_id	=, <, <=, >, >=	No	The consistency group ID.
	status	=	No	The mapping status. The valid input options for fcmap status are: <ul style="list-style-type: none"> • idle_copied • preparing • copying • stopped • suspended
copy_rate	=, <, <=, >, >=	No	The background copy rate.	
fcconsistgrp	name	=	Yes	The consistency group name.
	FC_group_id or id	=, <, <=, >, >=	No	The consistency group ID.
	status	=	No	The consistency group status. The valid value options are: <ul style="list-style-type: none"> • idle_or_copied • preparing • prepared • copying • stopped • suspended

Table 1. Valid filter attributes (continued)

Object	Attribute	Valid Qualifiers	Wildcard Valid	Description
rcrelationship	RC_rel_id or id	=, <, <=, >, >=	No	The Metro Mirror relationship ID.
	RC_rel_name or name	=	Yes	The Metro Mirror relationship name.
	master_cluster_id	=, <, <=, >, >=	No	The master cluster ID.
	master_cluster_name	=	Yes	The master cluster name.
	master_vdisk_id	=, <, <=, >, >=	No	The master VDisk ID.
	master_vdisk_name	=	Yes	The master VDisk name.
	aux_cluster_id	=, <, <=, >, >=	No	The aux cluster ID.
	aux_cluster_name	=	Yes	The aux cluster name.
	aux_vdisk_id	=, <, <=, >, >=	No	The aux VDisk ID.
	aux_vdisk_name	=	Yes	The aux VDisk name.
	primary	=	No	The relationship primary. The valid input values are: <ul style="list-style-type: none"> • master • aux
	consistency_group_id	=, <, <=, >, >=	No	The Metro Mirror consistency group ID.
	consistency_group_name	=	Yes	The Metro Mirror consistency group name.
	state	=	Yes	The relationship state. The valid input values are: <ul style="list-style-type: none"> • inconsistent_stopped • inconsistent_copying • consistent_stopped • consistent_synchronized • idling • idling_disconnected • inconsistent_disconnected • consistent_disconnected
progress	=, <, <=, >, >=	No	The progress of the initial background copy (synchronization) for the relationship.	

Table 1. Valid filter attributes (continued)

Object	Attribute	Valid Qualifiers	Wildcard Valid	Description
rconsistgrp	group_id or id	=, <, <=, >, >=	No	The consistency group ID.
	name	=	Yes	The consistency group name.
	master_cluster_id	=, <, <=, >, >=	No	The master cluster ID.
	master_cluster_name	=	Yes	The master cluster name.
	aux_cluster_id	=, <, <=, >, >=	No	The aux cluster ID.
	aux_cluster_name	=	Yes	The aux cluster name.
	primary	=	No	The consistency group primary. The valid input values are: <ul style="list-style-type: none"> • master • aux
	state	=	No	The consistency group state. The valid input values are: <ul style="list-style-type: none"> • inconsistent_stopped • inconsistent_copying • consistent_stopped • consistent_synchronized • idling • idling_disconnected • inconsistent_disconnected • consistent_disconnected • empty
relationship_count	=, <, <=, >, >=	No	The relationship count.	

Chapter 19. Overview of the list dump commands

You can use the list dumps command to return a list of dumps in the appropriate directory.

The dumps in the SAN Volume Controller are contained in the following directory structure:

- /dumps
- /dumps/audit
- /dumps/elogs
- /dumps/feature
- /dumps/iostats
- /dumps/iotrace

Software upgrade packages are contained in the /home/admin/upgrade directory. These directories exist on every node in the cluster.

Audit log dump: An audit log keeps track of action commands that are issued through an SSH session or the SAN Volume Controller Console. To list the audit log files in the /dumps/audit directory on the current configuration node or on the designated node, issue the **svcinfolsauditlogdumps** command. To list a specified number of the most recently audited commands, you can issue the **svctask catauditlog**. If you want to dump the contents of the audit log to a file on the current configuration node, you can issue the **svctask dumpauditlog** command. This command will also clear the contents of the audit log.

Error or event dump: Dumps contained in the /dumps/elogs directory are dumps of the contents of the error and event log at the time that the dump was taken. An error or event log dump is created by using the **svctask dumperrlog** command. This will dump the contents of the error or event log to the /dumps/elogs directory. If no filename prefix is supplied, the default errlog_ will be used. The full, default file name, will be errlog_NNNNNN_YYMMDD_HHMMSS (where NNNNNN is the node front panel name). If the command is used with the -prefix option, then the value entered for the -prefix will be used instead of errlog. The command to list all dumps in the /dumps/elogs directory is **svcinfolserlogdumps**.

Featurization log dump: Dumps contained in the /dumps/feature directory are dumps of the featurization log. A featurization log dump is created by using the **svctask dumpinternallog** command. This will dump the contents of the featurization log to the /dumps/feature directory to a file called feature.txt. Only one of these files exists, so every time the **svctask dumpinternallog** command is run, this file is overwritten. The command to list all dumps in the /dumps/feature directory is **svcinfolfeaturedumps**.

I/O statistics dump: Dumps contained in the /dumps/iostats directory are dumps of the I/O statistics for disks on the cluster. An I/O statistics dump is created by using the **svctask startstats** command. As part of this command, you can specify a time interval at which you want the statistics to be written to the file (the default is 15 minutes). Every time the time interval is encountered, the I/O statistics that have been collected this far are written to a file in the /dumps/iostats directory. The file names used for storing I/O statistics dumps are

m_stats_NNNNNN_YYMMDD_HHMMSS,
Nm_stats_NNNNNN_YYMMDD_HHMMSS, or
v_stats_NNNNNN_YYMMDD_HHMMSS (where *NNNNNN* is the node front panel name), depending on if the statistics are for MDisks or VDIs. The command to list all dumps in the `/dumps/iostats` directory is **svcinfolsiostatsdumps**.

I/O trace dump: Dumps contained in the `/dumps/iotrace` directory are dumps of I/O trace data. The type of data that is traced depends on the options specified by the **svctask settrace** command. The collection of the I/O trace data is started by using the **svctask starttrace** command. The I/O trace data collection is stopped when the **svctask stoptrace** command is used. It is when the trace is stopped that the data is written to the file. The file name will be `<prefix>_NNNNNN_YYMMDD_HHMMSS` (where *NNNNNN* is the node front panel name, and `<prefix>` is the value entered by the user for the `-filename` parameter in the **svctask settrace** command.) The command to list all dumps in the `/dumps/iotrace` directory is **svcinfolsiotracedumps**.

Application abends dump: Dumps contained in the `/dumps` directory are dumps resulting from application abends. Such dumps will be written to the `/dumps` directory. The default file names are `dump.NNNNNN.YYMMDD.HHMMSS` (where *NNNNNN* is the node front panel name). In addition to the dump file, it is possible that there may be some trace files written to this directory. These will be named `NNNNNN.trc`.

The command to list all dumps in the `/dumps` directory is **svcinfol2145dumps**.

The final option available in the list dumps command series is the **svcinfolsoftwareumps** command. This command will list the contents of the `/home/admin/upgrade` directory. Any files in this directory will have been copied there at the time that you wanted to perform a software upgrade.

All of the list dumps commands can accept a node identifier as input. If this identifier is not specified then the list of files on the current configuration node will be displayed. If the node identifier is specified, then the list of files on that node will be displayed.

Because files can only be copied off of the current configuration node (using secure copy), you can issue the **svctask cpumps** command to copy the files off of a non-configuration node to the current configuration node.

Chapter 20. Information commands

The following commands enable you to work with displaying specific types of information with the SAN Volume Controller.

Note: IDs are assigned at run-time by the system and cannot be relied upon to be the same after configuration restoration. Therefore, wherever possible, object names should be used in preference to IDs when working with objects.

caterrlog

The **caterrlog** command displays the contents of the cluster error and the event log.

Syntax

```
svcinfo -- caterrlog [-nohdr] [-delim delimiter]
                  [-config] [-unfixed] [-first number_of_entries_to_return]
```

Parameters

-nohdr

(Optional) Suppresses the display of these headings. By default, headings are displayed for each column of data (in a concise style view providing general information about objects of a particular type) and for each item of data (in a detailed style view providing much more information about a specific object of a particular type).

Note: If there is no data to be displayed (for example, an empty view), headings are not displayed whether the **-nohdr** option was used or not.

-delim delimiter

(Optional) By default in a concise view, all columns of data are space-separated. The width of each column is set to the maximum possible width of each item of data. In a detailed view, each item of data has its own row, and if the headers are displayed, the data is separated from the header by a space. The **-delim** parameter overrides this behavior. Valid input for the **-delim** parameter is a one-byte character. If, for example, you entered **-delim :**, a colon separates all items of data in a concise view (for example, the spacing of columns does not occur) and in a detailed view the data is separated from its header by a colon.

-config

(Optional) Specifies to list the configuration events.

-unfixed

(Optional) Specifies to list the unfixed errors.

-first number_of_entries_to_return

(Optional) Displays the first *x* number of entries in the log, where *x* is the number that is entered by the user. *x* must be between 1 and 256.

Description

This command displays a list of the specified error log entries. When no parameters are used, all error log entries are listed, up to a maximum of 256 entries.

The list can be filtered to only include configuration events or unfixed errors by specifying the **-config** or **-unfixed** parameters.

The **-first** parameter results in the display of the first *x* number of records, where *x* is the number that is entered for the **-first** parameter.

Possible failures

- CMMVC5786E The action failed because the cluster is not in a stable state.
- CMMVC6252E The command failed authorization because the session SSH key is wrong or was deleted.
- CMMVC6253E The command failed authorization because the session SSH key does not have the requisite role.

An invocation example

```
svcinfo caterrlog -delim :
```

The resulting output

```
id:type:fixed:SNMP_trap_raised:error_type:node_name:sequence_number:
root_sequence_number:first_timestamp:last_timestamp:number_of_errors:error_code
0:cluster:no:no:6:node1:100:100:030407052547:030407052547:1:00981001
0:fc_card:no:no:1:node1:101:101:030407052547:030407052547:1:00073001
1:node:no:no:1:node1:102:102:030407052547:030407052547:1:00074001
0:cluster:no:no:6:node1:103:100:030407052547:030407052547:1:00981001
1:fc_card:no:no:1:node1:104:104:030407052632:030407052632:1:00073003
0:node:no:6:node1:105:105:030407082202:030407082717:2:00980500
2:remote:no:no:6:n/a:106:106:030407090117:030407090117:1:00985002
1:node:no:no:5:node1:0:0:030407052546:030407052546:1:00990383
0:cluster:no:no:5:node1:0:0:030407080630:030407080630:1:00990117
0:mdisk_grp:no:no:5:node1:0:0:030407081610:030407081610:1:00990148
128:mdisk_grp:no:no:5:node1:0:0:030407081610:030407081610:1:00990173
1:mdisk_grp:no:no:5:node1:0:0:030407081619:030407081619:1:00990148
0:vdisk:no:no:5:node1:0:0:030407081836:030407081836:1:00990169
1:vdisk:no:no:5:node1:0:0:030407081843:030407081843:1:00990169
0:vdisk:no:no:5:node1:0:0:030407081854:030407081854:1:00990169
0:vdisk:no:no:5:node1:0:0:030407082015:030407082015:1:00990169
0:vdisk:no:no:5:node1:0:0:030407082145:030407082145:1:00990169
0:vdisk:no:no:5:node1:0:0:030407082148:030407082148:1:00990169
0:vdisk:no:no:5:node1:0:0:030407082158:030407082158:1:00990169
1:vdisk:no:no:5:node1:0:0:030407082213:030407082213:1:00990169
0:host:no:no:5:node1:0:0:030407082441:030407082441:1:00990106
1:host:no:no:5:node1:0:0:030407082457:030407082457:1:00990106
2:host:no:no:5:node1:0:0:030407082523:030407082523:1:00990106
0:flash:no:no:5:node1:0:0:030407082704:030407082704:1:00990184
1:node:no:no:5:node1:0:0:030407082716:030407082716:1:00990501
1:node:no:no:5:node1:0:0:030407082722:030407082722:1:00990501
1:fc_const_grp:no:no:5:node1:0:0:030407083141:030407083141:1:00990204
2:fc_const_grp:no:no:5:node1:0:0:030407083143:030407083143:1:00990204
3:fc_const_grp:no:no:5:node1:0:0:030407083145:030407083145:1:00990204
0:flash:no:no:5:node1:0:0:030407083318:030407083318:1:00990185
0:flash:no:no:5:node1:0:0:030407083355:030407083355:1:00990185
0:flash:no:no:5:node1:0:0:030407085753:030407085753:1:00990185
1:remote:no:no:5:node1:0:0:030407085932:030407085932:1:00990225
2:vdisk:no:no:5:node1:0:0:030407085959:030407085959:1:00990169
3:vdisk:no:no:5:node1:0:0:030407090004:030407090004:1:00990169
4:vdisk:no:no:5:node1:0:0:030407090013:030407090013:1:00990169
```

```

2:remote:no:no:5:node1:0:0:030407090106:030407090106:1:00990225
255:rc_const_grp:no:no:5:node1:0:0:030407090323:030407090323:1:00990240
254:rc_const_grp:no:no:5:node1:0:0:030407090327:030407090327:1:00990240
253:rc_const_grp:no:no:5:node1:0:0:030407090333:030407090333:1:00990240
2:remote:no:no:5:node1:0:0:030407090442:030407090442:1:00990226
1:vdisk:no:no:5:node1:0:0:030407090820:030407090820:1:00990182
3:vdisk:no:no:5:node1:0:0:030407090825:030407090825:1:00990182

```

caterrlogbyseqnum

The **caterrlogbyseqnum** command displays all the errors with a sequence number or root cause number, as specified by the user.

Syntax

```

▶— svcinfo — — caterrlogbyseqnum — — [ -num — sequence_number ] — —
                                     [ -root — root_cause_number ]
▶ [ -nohdr ] [ -delim — delimiter ]

```

Parameters

-num *sequence_number*

(Required if **-root** is not specified) Specifies the sequence number to view.

-root *root_cause_number*

(Required if **-num** is not specified) Specifies the root sequence number. All errors that are marked with this root cause are displayed.

-nohdr

(Optional) Suppresses the display of these headings. By default, headings are displayed for each column of data (in a concise style view providing general information about objects of a particular type) and for each item of data (in a detailed style view providing much more information about a specific object of a particular type).

Note: If there is no data to be displayed (for example, an empty view), headings are not displayed whether the **-nohdr** option was used or not.

-delim *delimiter*

(Optional) By default in a concise view, all columns of data are space-separated. The width of each column is set to the maximum possible width of each item of data. In a detailed view, each item of data has its own row, and if the headers are displayed, the data is separated from the header by a space. The **-delim** parameter overrides this behavior. Valid input for the **-delim** parameter is a one-byte character. If, for example, you entered **-delim :**, a colon separates all items of data in a concise view (for example, the spacing of columns does not occur) and in a detailed view the data is separated from its header by a colon.

Description

This command displays a single error log entry, determined by the sequence number that is specified as the **-num** parameter.

If the **-root** parameter is used, the log is searched for all entries that are marked with a root cause sequence number, as specified. A list of all entries marked with this root cause is displayed.

Possible failures

- CMMVC5786E The action failed because the cluster is not in a stable state.
- CMMVC6252E The command failed authorization because the session SSH key is wrong or was deleted.
- CMMVC6253E The command failed authorization because the session SSH key does not have the requisite role.

An invocation example

```
svcinfc caterrlogbyseqnum -num 100 -delim :
```

The resulting output

```
id:type:fixed:SNMP_trap_raised:error_type:node_name:sequence_number:
root_sequence_number:first_timestamp:last_timestamp:number_of_errors:
error_code
0:cluster:no:no:6:node1:100:100:030407052547:030407052547:1:00981001
```

ls2145dumps

The **ls2145dumps** command obtains a list of node assert dumps and the associated output files from the `/dumps` directory.

Syntax

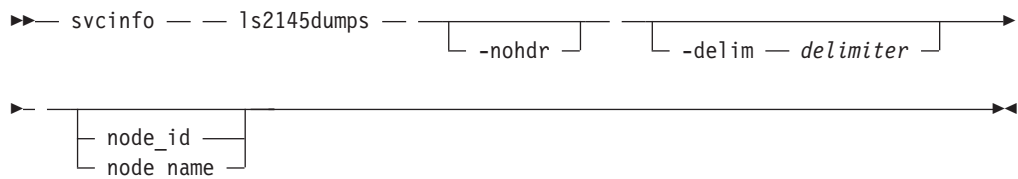

Parameters

-nohdr

(Optional) Suppresses the display of these headings. By default, headings are displayed for each column of data (in a concise style view providing general information about objects of a particular type) and for each item of data (in a detailed style view providing much more information about a specific object of a particular type).

Note: If there is no data to be displayed (for example, an empty view), headings are not displayed whether the **-nohdr** option was used or not.

-delim *delimiter*

(Optional) By default in a concise view, all columns of data are space-separated. The width of each column is set to the maximum possible width of each item of data. In a detailed view, each item of data has its own row, and if the headers are displayed, the data is separated from the header by a space. The **-delim** parameter overrides this behavior. Valid input for the **-delim** parameter is a one-byte character. If, for example, you entered **-delim ;**, a colon separates all items of data in a concise view (for example, the spacing of columns does not occur) and in a detailed view the data is separated from its header by a colon.

node_id | node_name

(Optional) Displays a list of the available dumps of the given type for the specified node ID or name. If you do not specify a node, the available dumps on the configuration node are listed.

Description

This command displays a list of node assert dumps and associated output files that are available. These dumps are created as a result of the assertion of a node. If you do not specify a node, the dumps available on the configuration node are listed. The command displays files from the /dumps directory.

Possible failures

- CMMVC5786E The action failed because the cluster is not in a stable state.
- CMMVC6252E The command failed authorization because the session SSH key is wrong or was deleted.
- CMMVC6253E The command failed authorization because the session SSH key does not have the requisite role.

An invocation example

```
svcinfols2145dumps -delim :
```

The resulting output

```
id:2145_filename  
0:000108.trc.old  
1:dump.000108.030328.144007  
2:000108.trc
```

lscopystatus

Use the **lscopystatus** command to determine whether any file copies are currently in progress.

Syntax

```
svcinfolscopystatus [-nohdr] [-delim delimiter]
```

Parameters

-nohdr

(Optional) Suppresses the display of these headings. By default, headings are displayed for each column of data (in a concise style view providing general information about objects of a particular type) and for each item of data (in a detailed style view providing much more information about a specific object of a particular type).

Note: If there is no data to be displayed (for example, an empty view), headings are not displayed whether the **-nohdr** option was used or not.

-delim delimiter

(Optional) By default in a concise view, all columns of data are space-separated. The width of each column is set to the maximum possible

width of each item of data. In a detailed view, each item of data has its own row, and if the headers are displayed, the data is separated from the header by a space. The **-delim** parameter overrides this behavior. Valid input for the **-delim** parameter is a one-byte character. If, for example, you entered **-delim ;**, a colon separates all items of data in a concise view (for example, the spacing of columns does not occur) and in a detailed view the data is separated from its header by a colon.

Description

This command displays an indicator that shows if a file copy is currently in progress. Only one file can be copied in the cluster at a time.

Possible failures

- CMMVC5786E The action failed because the cluster is not in a stable state.
- CMMVC6252E The command failed authorization because the session SSH key is wrong or was deleted.
- CMMVC6253E The command failed authorization because the session SSH key does not have the requisite role.

An invocation example

```
svcinfo lscopystatus
```

The resulting output

```
status
  active
```

lscluster

The **lscluster** command provides a report that you can designate as a concise list or a detailed list, of clusters. The list provides possible values that are applicable to the attributes that are displayed as data in the output views.

The list report can provide two styles of report:

- A list containing concise information about all clusters. (Each entry in the list corresponds to a single cluster.)
- The detailed information about a single, user-specified cluster.

Syntax

```

▶▶▶ svcinfo — — lscluster — [ -filtervalue — attrib=value ] —————▶
▶ [ -nohdr ] [ -bytes ] [ -delim — delimiter ] —————▶
▶ [ object_id — name ] [ -filtervalue? ] —————▶

```

Parameters

-filtervalue *attribute=value*

(Optional) Specifies a list of one or more filters. Only objects with a value that matches the filter attribute value are displayed. If a capacity is specified, the units must also be included.

Note: Some filters allow the use of an asterisk (*) when you enter the command. The following rules apply to the use of wildcards with the SAN Volume Controller CLI:

- The wildcard character is an asterisk (*).
- The command can contain a maximum of one wildcard.
- When you use a wildcard, it is important to surround that filter entry with double quotation marks like the following display:

```
>svcinfolcluster -filtervalue "name=md*"
```

-nohdr

(Optional) By default, headings are displayed for each column of data (in a concise style view) and each item of data (in a detailed style view). The **-nohdr** parameter suppresses the display of these headings.

Note: If there is no data to be displayed (an empty view), headings are not displayed even if the **-nohdr** option is used.

-bytes

(Optional) Specifies that you want the report to display all capacities as bytes.

-delim *delimiter*

(Optional) By default in a concise view, all columns of data are space-separated. The width of each column is set to the maximum possible width of each item of data. In a detailed view, each item of data has its own row, and if the headers are displayed, the data is separated from the header by a space. The **-delim** parameter overrides this behavior. Valid input for the **-delim** parameter is a one-byte character. If you enter **-delim :** on the command line, a colon separates all items of data in a concise view; the spacing of columns does not occur. In a detailed view, the data is separated from its header by a colon.

object_id | name

(Optional) Specifies the name or ID of an object. When you use this parameter, the detailed view of the specific object is displayed and any value that you specified by the **-filtervalue** parameter is ignored. If you do not specify the **-object_ID** or **object_name** parameter, the concise view of all objects that match the filtering requirements that are specified by the **-filtervalue** parameter are displayed.

-filtervalue?

(Optional) Specifies that you want your report to display any or all of the list of valid filter attributes. The following filter attributes are valid for the **lscluster** command:

- cluster_name
- cluster_unique_id
- id
- name

Description

This command displays a concise list or a detailed list of clusters.

The following list provides possible values that are applicable to the attributes that are displayed as data in the output views:

Attribute	Possible Values
location	local, remote
statistics status	on, off
SNMP setting	none, all, hardware_only
email_state	running, stopped, invalid

The location, partnership, and bandwidth fields are relevant to Metro or Global Mirror configurations where the SAN fabrics of two clusters are linked together. Information about the remote cluster is reported by the **lscluster** command if the **mkpartnership** command has been issued from the local cluster to the remote cluster. For example, if the partnership has been at least partially established from the local cluster.

You can issue the **svcinfo lscluster** command to display a concise view of the cluster.

```
svcinfo lscluster -delim : 10030a007e5
```

where *10030a007e5* is the name of the cluster. The output from this command includes the following information for each cluster on the fabric:

- cluster name
- cluster IP address
- cluster service IP address

For the remote cluster, these fields indicate the following information:

- Location: remote
- Partnership:
 - partially_configured (the **mkpartnership** command has only been issued from the local cluster to the remote cluster)
 - fully_configured (the **mkpartnership** command has been issued in both directions)
- Bandwidth: MB/sec (the available bandwidth on the intercluster a link for background copy)

Possible failures

- CMMVC5786E The action failed because the cluster is not in a stable state.
- CMMVC5804E The action failed because an entity that was specified in the command does not exist.
- CMMVC6252E The command failed authorization because the session SSH key is wrong or was deleted.
- CMMVC6253E The command failed authorization because the session SSH key does not have the requisite role.

A concise invocation example

```
svcinfo lscluster -delim :
```

The concise resulting output

```
id:name:location:partnership:bandwidth:cluster_IP_address:  
cluster_service_ip_address:id_alias  
0000020062813ABA:clusterA:local:::9.20.247.210:1.1.1.1:0000020062813ABA  
0000020062006746:clusterB:remote:fully_configured:50:9.20.247.211:  
1.1.1.1:0000020062006746
```

A detailed invocation example

```
svcinfo lscluster -delim : 0000020064E05308
```

The detailed resulting output

```
id:0000020064E05308  
name:rc-cluster-20  
location:local  
partnership:  
bandwidth:  
cluster_IP_address:9.71.50.32  
cluster_service_IP_address:9.71.50.183  
total_mdisk_capacity:2976.9GB  
space_in_mdisk_grps:::2976.9GB  
space_allocated_to_vdisks:147.2GB  
total_free_space:2828.7GB  
statistics_status:on  
statistics_frequency:15  
required_memory:8192  
cluster_locale:en_US  
SNMP_setting:none  
SNMP_community:  
SNMP_server_IP_address:0.0.0.0  
subnet_mask:255.255.254.0  
default_gateway:9.71.50.1  
time_zone:522 UTC  
email_setting:none  
email_id:  
code_level:4.1.0.12 (build 5.13.0610240000)  
FC_port_speed:2Gb  
console_IP:9.71.49.176:9080  
id_alias:0000020064C05308  
gm_link_tolerance:300  
gm_inter_cluster_delay_simulation:0  
gm_intra_cluster_delay_simulation:0  
email_server 8.53.26.131  
email_server_port 25  
email_reply fred@mycompany.com  
email_contact Fred Higgins  
email_contact_primary 01202 123456  
email_contact_alternate 44-212-786543-4455  
email_contact_location London Banking  
email_state running  
email_user_count 2  
inventory_mail_interval:0
```

Isclustercandidate

The **Isclustercandidate** command lists the clusters that are available for setting up a two-cluster partnership. This is a prerequisite for creating intercluster Metro or Global Mirror relationships.

Syntax

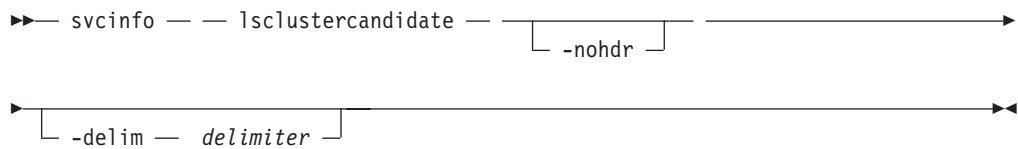

Parameters

-nohdr

(Optional) Suppresses the display of these headings. By default, headings are displayed for each column of data (in a concise style view providing general information about objects of a particular type) and for each item of data (in a detailed style view providing much more information about a specific object of a particular type).

Note: If there is no data to be displayed (for example, an empty view), headings are not displayed whether the **-nohdr** option was used or not.

-delim *delimiter*

(Optional) By default in a concise view, all columns of data are space-separated. The width of each column is set to the maximum possible width of each item of data. In a detailed view, each item of data has its own row, and if the headers are displayed, the data is separated from the header by a space. The **-delim** parameter overrides this behavior. Valid input for the **-delim** parameter is a one-byte character. If, for example, you entered **-delim ;**, a colon separates all items of data in a concise view (for example, the spacing of columns does not occur) and in a detailed view the data is separated from its header by a colon.

Description

This command displays a list of clusters that are available as candidate partner clusters to form a Metro or Global Mirror Partnership between two clusters.

Possible failures

- CMMVC5786E The action failed because the cluster is not in a stable state.
- CMMVC5804E The action failed because an entity that was specified in the command does not exist.
- CMMVC6252E The command failed authorization because the session SSH key is wrong or was deleted.
- CMMVC6253E The command failed authorization because the session SSH key does not have the requisite role.

An invocation example

```
svcinfo lsclustercandidate
```

The resulting output

id	configured	cluster_name
0000010034E0F430	no	ldcluster26

lscontroller

The **lscontroller** command returns a concise list, or a detailed view, of controllers visible to the cluster.

The list report style can be used to obtain two styles of report.

1. A list containing concise information about controllers. (Each entry in the list corresponds to a single controller.)
2. The detailed information about a single, user specified, controller.

Syntax

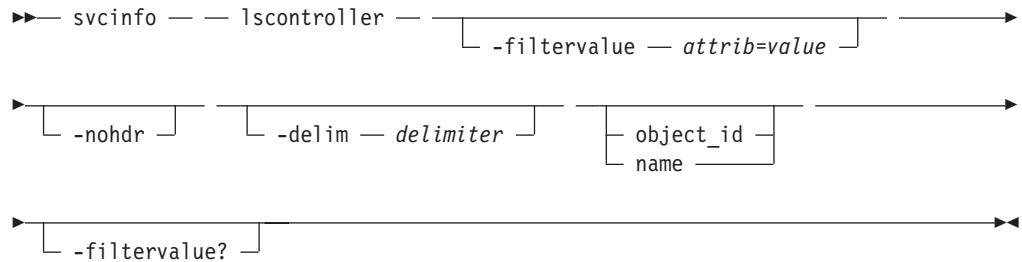

Parameters

-filtervalue *attribute=value*

(Optional) Specifies a list of one or more filters. Only objects with a value that matches the filter attribute value are returned. If a capacity is specified, the units must also be included.

Note: Some filters allow the use of a wildcard when entering the command. The following rules apply to the use of wildcards with the SAN Volume Controller CLI:

- The wildcard character is an asterisk (*).
- The command can contain a maximum of one wildcard.
- When using a wildcard, it is important to surround that filter entry with double quotes like the following display:

```
>svcinfo lscontroller -filtervalue "name=md*"
```

-nohdr

(Optional) By default, headings are displayed for each column of data (in a concise style view) and each item of data (in a detailed style view). The **-nohdr** parameter suppresses the display of these headings.

Note: If there is no data to be displayed (for example, an empty view has been returned), then headings are not displayed irrespective of whether the **-nohdr** option was used or not.

-delim *delimiter*

(Optional) By default in a concise view, all columns of data are space separated. The width of each column is set to the maximum possible width of each item of data. In a detailed view, each item of data has its own row, and if the headers are displayed the data is separated from the header by a space. The **-delim** parameter overrides this behavior. Valid input for the **-delim** parameter is a one byte character. If you enter `-delim :` on the command line,

a colon is used to separate all items of data in a concise view; the spacing of columns does not occur. In a detailed view, the data is separated from its header by a colon.

object_id | name

(Optional) Specifies the name or ID of an object. When you use this parameter, the detailed view of the specific object is returned and any value that is specified by the **-filtervalue** parameter is ignored. If you do not specify the **-object_ID** or **object_name** parameter, the concise view of all objects matching the filtering requirements that is specified by the **-filtervalue** parameter are displayed.

-filtervalue?

(Optional) Specifies that you want your report to display any or all of the list of valid filter attributes. The valid filter attributes for the **svcinfo lscontroller** command are:

- controller_id
- id

Description

This command returns a concise list or a detailed view, of controllers visible to the cluster.

The following list provides possible values that are applicable to the attributes that are displayed as data in the output views:

degraded	no, yes
----------	---------

Determining a storage controllers name from the name shown on the cluster:

List the storage controllers by issuing the **svcinfo lscontroller** command. Remember the controller name or ID for the controller you want to determine. For the controller in question, issue the **svcinfo lscontroller <controllername/id>** command, where *<controllername/id>* is the controller name or ID. Remember the worldwide node name (WWNN) for the controller. Make a written record of it. The WWNN can be used to determine the actual storage controller by launching the native controller user interface or using the command line tools it provides to verify the actual controller that has this WWNN.

Determining the relationship between MDisks and RAID arrays or LUNs: Each MDisk corresponds with a single RAID array, or a single partition on a given RAID array. Each RAID controller will define a LUN number for this disk. The LUN number and controller name or ID are needed to be able to determine the relationship between mdisks and RAID arrays or partitions.

Show the detailed view of the given MDisk *<mdiskname>*, by issuing the **svcinfo lsmdisk <mdiskname>** command, where *<mdiskname>* is the name of the MDisk.

Note: Remember the controller name or controller ID and controller LUN number. Show the detailed view of the controller determined in by issuing the **svcinfo lscontroller <controllername>** command, where *<controllername>* is the name of the controller.

Note: Remember the vendor ID, product ID, and WWNN. Use these to determine what is being presented to the MDisk.

From the native user interface for the given controller, list the LUNs it is

presenting and match the LUN number. This will tell you the exact RAID array or partition that corresponds with the MDisk.

path_count is the number of MDisks multiplied by the number of controller ports, through which those MDisks are visible.

max_path_count is the highest possible value that path_count could reach for that controller type.

Possible failures

- CMMVC5786E The action failed because the cluster is not in a stable state.
- CMMVC5804E The action failed because an entity that was specified in the command does not exist.
- CMMVC6252E The command failed authorization because the session SSH key is wrong or was deleted.
- CMMVC6253E The command failed authorization because the session SSH key does not have the requisite role.

A concise invocation example

```
svcinfo lscontroller -delim :
```

The concise resulting output

```
id:controller_name:ctrl_s/n:vendor_id:product_id_low:product_id_high
7:controller7:3EK0J5Y8:SEAGATE :ST373405:FC
8:controller8:3EK0J6CR:SEAGATE :ST373405:FC
9:controller9:3EK0J4YN:SEAGATE :ST373405:FC
10:controller10:3EK0GKGH:SEAGATE :ST373405:FC
11:controller11:3EK0J85C:SEAGATE :ST373405:FC
12:controller12:3EK0JBR2:SEAGATE :ST373405:FC
13:controller13:3EKYNJF8:SEAGATE :ST373405:FC
14:controller14:3EK0HVTM:SEAGATE :ST373405:FC
```

A detailed invocation example

```
svcinfo lscontroller -delim = 7
```

The detailed resulting output

```
id=7
controller_name=controller7
WWNN=20000004CF2412AC
mdisk_link_count=1
max_mdisk_link_count=1
degraded=no
vendor_id=SEAGATE
product_id_low=ST373405
product_id_high=FC
product_revision=0003
ctrl_s/n=3EK0J5Y8
WWPN=22000004CF2412AC
path_count=1
max_path_count=1
WWPN=21000004CF2412AC
path_count=0
max_path_count=0
```

lsdiscoverystatus

Use the **lsdiscoverystatus** command to determine whether or not a discovery operation is in progress.

Syntax

```
svcinfo lsdiscoverystatus [-nohdr]
                             [ -delim delimiter ]
```

Parameters

-nohdr

(Optional) Suppresses the display of these headings. By default, headings are displayed for each column of data (in a concise style view providing general information about objects of a particular type) and for each item of data (in a detailed style view providing much more information about a specific object of a particular type).

Note: If there is no data to be displayed (for example, an empty view), headings are not displayed whether the **-nohdr** option was used or not.

-delim *delimiter*

(Optional) By default in a concise view, all columns of data are space-separated. The width of each column is set to the maximum possible width of each item of data. In a detailed view, each item of data has its own row, and if the headers are displayed, the data is separated from the header by a space. The **-delim** parameter overrides this behavior. Valid input for the **-delim** parameter is a one-byte character. If, for example, you entered **-delim :**, a colon separates all items of data in a concise view (for example, the spacing of columns does not occur) and in a detailed view the data is separated from its header by a colon.

Description

This command displays one of the following results:

active If there is a discovery operation in progress at the time that the command is issued.

inactive

If there are no discovery operations in progress at the time that the command is issued.

Possible failures

- CMMVC5786E The action failed because the cluster is not in a stable state.
- CMMVC6252E The command failed authorization because the session SSH key is wrong or was deleted.
- CMMVC6253E The command failed authorization because the session SSH key does not have the requisite role.

An invocation example

```
svcinfo lsdiscoverystatus
```

The resulting output

```
status
inactive
```

lserrlogbyfcconsistgrp

The **lserrlogbyfcconsistgrp** command displays errors and events in the log that are related to FlashCopy consistency groups.

Syntax

```
▶— svcinfo — — lserrlogbyfcconsistgrp — [ -nohdr ] —————▶  
[ -delim — delimiter ] [ -count — number ] [ -config ] [ -unfixed ] —————▶  
[ fcconsistgrp_id — ] [ fcconsistgrp_name ] —————▶
```

Parameters

-nohdr

(Optional) Suppresses the display of these headings. By default, headings are displayed for each column of data (in a concise style view providing general information about objects of a particular type) and for each item of data (in a detailed style view providing much more information about a specific object of a particular type).

Note: If there is no data to be displayed (for example, an empty view), headings are not displayed whether the **-nohdr** option was used or not.

-delim *delimiter*

(Optional) By default in a concise view, all columns of data are space-separated. The width of each column is set to the maximum possible width of each item of data. In a detailed view, each item of data has its own row, and if the headers are displayed, the data is separated from the header by a space. The **-delim** parameter overrides this behavior. Valid input for the **-delim** parameter is a one-byte character. If, for example, you entered **-delim :**, a colon separates all items of data in a concise view (for example, the spacing of columns does not occur) and in a detailed view the data is separated from its header by a colon.

-count *number*

(Optional) Specifies the maximum number of errors or events to list.

-config

(Optional) Lists only configuration events.

-unfixed

(Optional) Lists only unfixed errors.

fcconsistgrp_id | **fcconsistgrp_name**

(Optional) Specifies the object ID that filters the log.

Description

This command displays a list of the errors and events in the log that are related to FlashCopy consistency groups. The list can be filtered further by specifying an object ID or object name. The list displays only the errors and events that have been logged against the specified object. The list can also be filtered to show only

the configuration events or the unfixed errors for the given object type or object ID. Similarly, the last *x* number of entries for a given object type or object ID can be listed.

Note: Although there is an object type of *unknown* is displayed in the error log, there is no command available to filter this object type.

Possible failures

- CMMVC5786E The action failed because the cluster is not in a stable state.
- CMMVC6252E The command failed authorization because the session SSH key is wrong or was deleted.
- CMMVC6253E The command failed authorization because the session SSH key does not have the requisite role.

An invocation example

```
svcinfo lserrlogbyfcconsistgrp -delim :
```

The resulting output

```
id:type:fixed:SNMP_trap_raised:error_type:node_name:sequence_number:
root_sequence_number:first_timestamp:last_timestamp:number_of_errors:error_code
3:fc_const_grp:no:no:5:node1:0:0:030407083145:030407083145:1:00990204
2:fc_const_grp:no:no:5:node1:0:0:030407083143:030407083143:1:00990204
1:fc_const_grp:no:no:5:node1:0:0:030407083141:030407083141:1:00990204
```

lserrlogbyfcmap

The **lserrlogbyfcmap** command displays a list of the errors and events in the log that are related to FlashCopy mappings.

Syntax

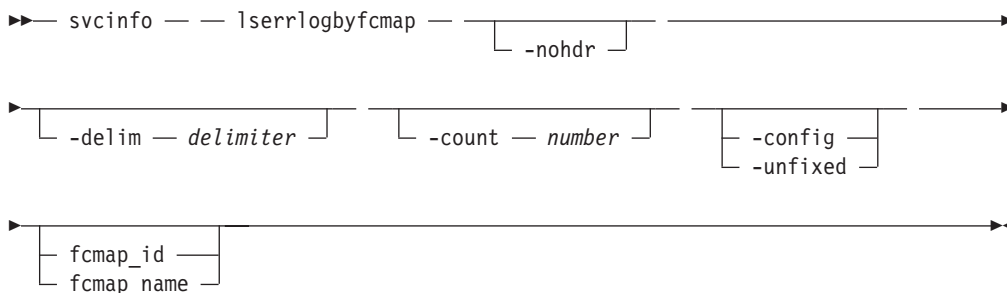

Parameters

-nohdr

(Optional) Suppresses the display of these headings. By default, headings are displayed for each column of data (in a concise style view providing general information about objects of a particular type) and for each item of data (in a detailed style view providing much more information about a specific object of a particular type).

Note: If there is no data to be displayed (for example, an empty view), headings are not displayed whether the **-nohdr** option was used or not.

-delim *delimiter*

(Optional) By default in a concise view, all columns of data are

space-separated. The width of each column is set to the maximum possible width of each item of data. In a detailed view, each item of data has its own row, and if the headers are displayed, the data is separated from the header by a space. The **-delim** parameter overrides this behavior. Valid input for the **-delim** parameter is a one-byte character. If, for example, you entered **-delim ;**, a colon separates all items of data in a concise view (for example, the spacing of columns does not occur) and in a detailed view the data is separated from its header by a colon.

-count *number*

(Optional) Specifies the maximum number of errors or events to list.

-config

(Optional) Lists only configuration events.

-unfixed

(Optional) Lists only unfixed errors.

fcmap_id | fcmap_name

(Optional) Specifies the object ID that filters the log.

Description

This command displays a list of the errors and events in the log that are related to FlashCopy mappings. The list can be filtered further by specifying a specific object ID or name. This list displays only the errors and events that have been logged against the specified object. The list can also be filtered to show only the configuration events or the unfixed errors for the given object type or object ID. Similarly, the last *x* entries against a given object type or object ID can be listed.

Note: Although an object type of *unknown* is displayed in the error log, there is no available command to filter this object type.

Possible failures

- CMMVC5786E The action failed because the cluster is not in a stable state.
- CMMVC6252E The command failed authorization because the session SSH key is wrong or was deleted.
- CMMVC6253E The command failed authorization because the session SSH key does not have the requisite role.

An invocation example

```
svcinfolerrlogbyfcmap -delim ;
```

The resulting output

```
id:type:fixed:SNMP_trap_raised:error_type:node_name:sequence_number:
root_sequence_number:first_timestamp:last_timestamp:number_of_errors:error_code
0:flash:no:no:5:node1:0:0:030407085753:030407085753:1:00990185
0:flash:no:no:5:node1:0:0:030407083355:030407083355:1:00990185
0:flash:no:no:5:node1:0:0:030407083318:030407083318:1:00990185
0:flash:no:no:5:node1:0:0:030407082704:030407082704:1:00990184
```

lserrlogbyhost

The **lserrlogbyhost** command displays a list of the errors and events in the log that are related to hosts.

Syntax

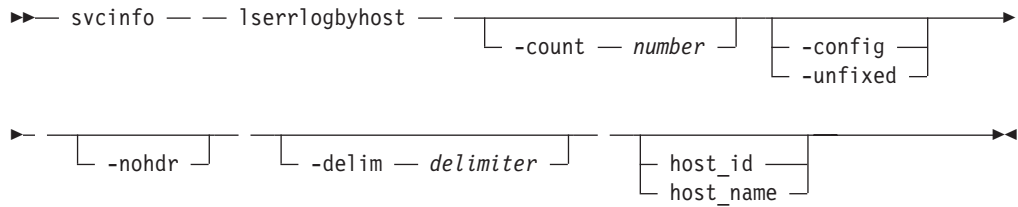

Parameters

-count *number*

(Optional) Specifies the maximum number of errors or events to list.

-config

(Optional) Lists only configuration events.

-unfixed

(Optional) Lists only unfixed errors.

-nohdr

(Optional) Suppresses the display of these headings. By default, headings are displayed for each column of data (in a concise style view providing general information about objects of a particular type) and for each item of data (in a detailed style view providing much more information about a specific object of a particular type).

Note: If there is no data to be displayed (for example, an empty view), headings are not displayed whether the **-nohdr** option was used or not.

-delim *delimiter*

(Optional) By default in a concise view, all columns of data are space-separated. The width of each column is set to the maximum possible width of each item of data. In a detailed view, each item of data has its own row, and if the headers are displayed, the data is separated from the header by a space. The **-delim** parameter overrides this behavior. Valid input for the **-delim** parameter is a one-byte character. If, for example, you entered **-delim ;**, a colon separates all items of data in a concise view (for example, the spacing of columns does not occur) and in a detailed view the data is separated from its header by a colon.

host_id | **host_name**

(Optional) Specifies the object ID that filters the log.

Description

This command displays a list of the errors and events in the log that are related to hosts. The list can be filtered further by specifying a specific object ID or name. This list displays only the errors and events that have been logged against the specified object. The list can also be filtered to show only the configuration events or the unfixed errors for the given object type or object ID. Similarly, the last *x* entries against a given object type or object ID can be listed.

Note: Although an object type *unknown* is displayed in the error log, there is no available command to filter this object type.

Possible failures

- CMMVC5786E The action failed because the cluster is not in a stable state.
- CMMVC6252E The command failed authorization because the session SSH key is wrong or was deleted.
- CMMVC6253E The command failed authorization because the session SSH key does not have the requisite role.

An invocation example

```
svcinfo lserrlogbyhost -delim :
```

The resulting output

```
id:type:fixed:SNMP_trap_raised:error_type:node_name:sequence_number:
root_sequence_number:first_timestamp:last_timestamp:number_of_errors:error_code
2:host:no:no:5:node1:0:0:030407082523:030407082523:1:00990106
1:host:no:no:5:node1:0:0:030407082457:030407082457:1:00990106
0:host:no:no:5:node1:0:0:030407082441:030407082441:1:00990106
```

lserrlogbyiogrp

The **lserrlogbyiogrp** command displays a list of the errors and events in the log that are related to I/O groups.

Syntax

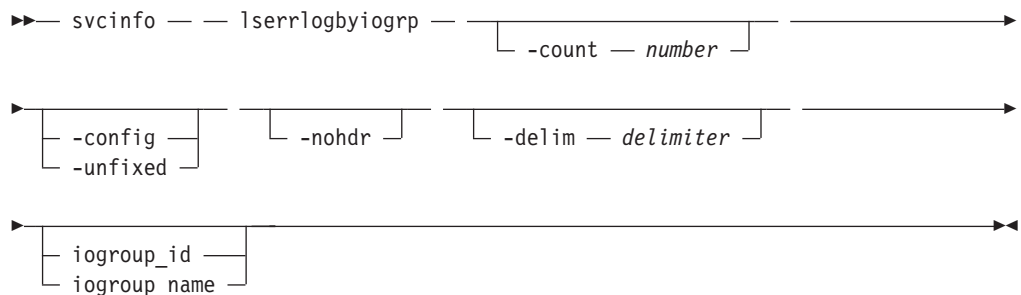

Parameters

-count *number*

(Optional) Specifies the maximum number of errors or events to list.

-config

(Optional) Lists only configuration events.

-unfixed

(Optional) Lists only unfixed errors.

-nohdr

(Optional) Suppresses the display of these headings. By default, headings are displayed for each column of data (in a concise style view providing general information about objects of a particular type) and for each item of data (in a detailed style view providing much more information about a specific object of a particular type).

Note: If there is no data to be displayed (for example, an empty view), headings are not displayed whether the **-nohdr** option was used or not.

-delim *delimiter*

(Optional) By default in a concise view, all columns of data are

space-separated. The width of each column is set to the maximum possible width of each item of data. In a detailed view, each item of data has its own row, and if the headers are displayed, the data is separated from the header by a space. The **-delim** parameter overrides this behavior. Valid input for the **-delim** parameter is a one-byte character. If, for example, you entered **-delim ;**, a colon separates all items of data in a concise view (for example, the spacing of columns does not occur) and in a detailed view the data is separated from its header by a colon.

iogroup_id | iogroup_name

(Optional) Specifies the object ID that filters the log.

Description

This command displays a list of the errors and events in the log that are related to I/O groups. The list can be filtered further by specifying a specific object ID or name. This list displays only the errors and events that have been logged against the specified object. The list can also be filtered to show only the configuration events or the unfixed errors for the given object type or object ID. Similarly, the last *x* entries against a given object type or object ID can be listed.

Note: Although an object type *unknown* is displayed in the error log, there is no available command to filter this object type.

Possible failures

- CMMVC5786E The action failed because the cluster is not in a stable state.
- CMMVC6252E The command failed authorization because the session SSH key is wrong or was deleted.
- CMMVC6253E The command failed authorization because the session SSH key does not have the requisite role.

An invocation example

```
svcinfp lserrlogbyiogrp -delim :
```

The resulting output

```
id:type:fixed:SNMP_trap_raised:error_type:node_name:sequence_number:
root_sequence_number:first_timestamp:last_timestamp:number_of_errors:error_code
1:io_grp:no:no:1:nodel:109:109:030407094417:030407094417:1:00000001
```

lserrlogbymdisk

The **lserrlogbymdisk** command displays a list of the errors and events in the log that are related to a specific MDisk.

Syntax

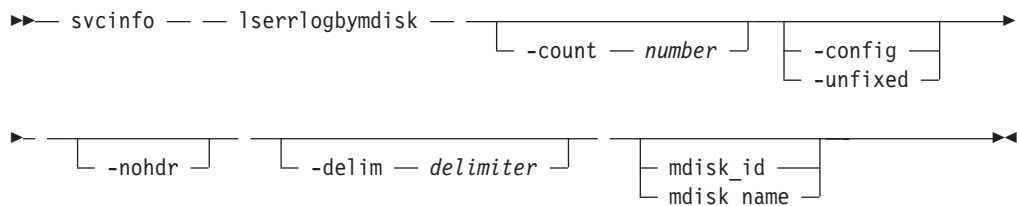

Parameters

-count *number*

(Optional) Specifies the maximum number of errors or events to list.

-config

(Optional) Lists only configuration events.

-unfixed

(Optional) Lists only unfixed errors.

-nohdr

(Optional) Suppresses the display of these headings. By default, headings are displayed for each column of data (in a concise style view providing general information about objects of a particular type) and for each item of data (in a detailed style view providing much more information about a specific object of a particular type).

Note: If there is no data to be displayed (for example, an empty view), headings are not displayed whether the **-nohdr** option was used or not.

-delim *delimiter*

(Optional) By default in a concise view, all columns of data are space-separated. The width of each column is set to the maximum possible width of each item of data. In a detailed view, each item of data has its own row, and if the headers are displayed, the data is separated from the header by a space. The **-delim** parameter overrides this behavior. Valid input for the **-delim** parameter is a one-byte character. If, for example, you entered **-delim ;**, a colon separates all items of data in a concise view (for example, the spacing of columns does not occur) and in a detailed view the data is separated from its header by a colon.

mdisk_id | mdisk_name

(Optional) Specifies the object ID that filters the log.

Description

This command displays a list of the errors and events in the log that are related to a specific MDisk. The list can be filtered further by specifying a specific object ID or name. This list displays only the errors and events that have been logged against the specified object. The list can also be filtered to show only the configuration events or the unfixed errors for the given object type or object ID. Similarly, the last *x* entries against a given object type or object ID can be listed.

Note: Although an object type *unknown* is displayed in the error log, there is no available command to filter this object type.

Possible failures

- CMMVC5786E The action failed because the cluster is not in a stable state.
- CMMVC6252E The command failed authorization because the session SSH key is wrong or was deleted.
- CMMVC6253E The command failed authorization because the session SSH key does not have the requisite role.

An invocation example

```
svcinfo lserrlogbydisk -delim :
```

The resulting output

```

id:type:fixed:SNMP_trap_raised:error_type:node_name:
sequence_number:root_sequence_number:first_timestamp:
last_timestamp:number_of_errors:error_code
11:mdisk:no:no:3:node1:108:108:030407092947:030407092947:1:00000016
11:mdisk:no:no:2:node1:107:107:030407092947:030407092947:1:00000016

```

lserrlogbymdiskgroup

The **lserrlogbymdiskgroup** commands display a list of the errors and events in the log that are related to MDisk groups.

Syntax

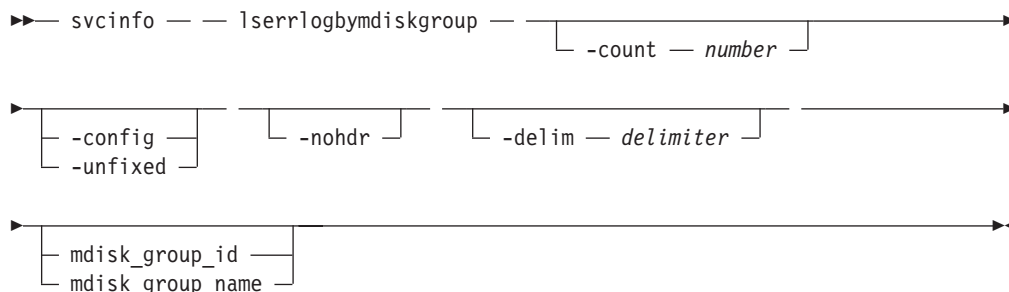

Parameters

-count *number*

(Optional) Specifies the maximum number of errors or events to list.

-config

(Optional) Lists only configuration events.

-unfixed

(Optional) Lists only unfixed errors.

-nohdr

(Optional) Suppresses the display of these headings. By default, headings are displayed for each column of data (in a concise style view providing general information about objects of a particular type) and for each item of data (in a detailed style view providing much more information about a specific object of a particular type).

Note: If there is no data to be displayed (for example, an empty view), headings are not displayed whether the **-nohdr** option was used or not.

-delim *delimiter*

(Optional) By default in a concise view, all columns of data are space-separated. The width of each column is set to the maximum possible width of each item of data. In a detailed view, each item of data has its own row, and if the headers are displayed, the data is separated from the header by a space. The **-delim** parameter overrides this behavior. Valid input for the **-delim** parameter is a one-byte character. If, for example, you entered **-delim ;**, a colon separates all items of data in a concise view (for example, the spacing of columns does not occur) and in a detailed view the data is separated from its header by a colon.

mdisk_group_id | **mdisk_group_name**

(Optional) Specifies the object ID that filters the log.

Description

This command displays a list of the errors and events in the log that are related to MDisk groups. The list can be filtered further by specifying a specific object ID or name. This list displays only the errors and events that have been logged against the specified object. The list can also be filtered to show only the configuration events or the unfixed errors for the given object type or object ID. Similarly, the last *x* entries against a given object type or object ID can be listed.

Note: Although an object type *unknown* is displayed in the error log, there is no available command to filter this object type.

Possible failures

- CMMVC5786E The action failed because the cluster is not in a stable state.
- CMMVC6252E The command failed authorization because the session SSH key is wrong or was deleted.
- CMMVC6253E The command failed authorization because the session SSH key does not have the requisite role.

An invocation example

```
svcinfo lserrlogbydiskgrp -delim :
```

The resulting output

```
id:type:fixed:SNMP_trap_raised:error_type:node_name:sequence_number:  
root_sequence_number:first_timestamp:last_timestamp:number_of_errors:error_code  
1:mdisk_grp:no:no:5:node1:0:0:030407081619:030407081619:1:00990148  
128:mdisk_grp:no:no:5:node1:0:0:030407081610:030407081610:1:00990173  
0:mdisk_grp:no:no:5:node1:0:0:030407081610:030407081610:1:00990148
```

lserrlogbynode

The **lserrlogbynode** command displays a list of the errors and events in the log that are related to nodes.

Syntax

```
▶▶▶ svcinfo — — lserrlogbynode — —————▶▶▶  
                                     └─ -count — number ─┘  
  
▶ ┌───┬───┬───┬───┬───┬───┬───┬───┬───┬───▶  
  │ -config │ -nohdr │ -delim — delimiter │  
  └───┬───┘  
      │ -unfixed │  
      └───┘  
  
▶ ┌───┬───▶▶▶  
  │ node_id │  
  └───┬───▶▶▶  
      │ node_name │  
      └───┘
```

Parameters

-count *number*

(Optional) Specifies the maximum number of errors or events to list.

-config

(Optional) Lists only configuration events.

-unfixed

(Optional) Lists only unfixed errors.

-nohdr

(Optional) Suppresses the display of these headings. By default, headings are displayed for each column of data (in a concise style view providing general information about objects of a particular type) and for each item of data (in a detailed style view providing much more information about a specific object of a particular type).

Note: If there is no data to be displayed (for example, an empty view), headings are not displayed whether the **-nohdr** option was used or not.

-delim delimiter

(Optional) By default in a concise view, all columns of data are space-separated. The width of each column is set to the maximum possible width of each item of data. In a detailed view, each item of data has its own row, and if the headers are displayed, the data is separated from the header by a space. The **-delim** parameter overrides this behavior. Valid input for the **-delim** parameter is a one-byte character. If, for example, you entered **-delim ;**, a colon separates all items of data in a concise view (for example, the spacing of columns does not occur) and in a detailed view the data is separated from its header by a colon.

node_id | node_name

(Optional) Specifies the object ID that filters the log.

Description

This command displays a list of the errors and events in the log that are related to nodes. The list can be filtered further by specifying a specific object ID or name. This list displays only the errors and events that have been logged against the specified object. The list can also be filtered to show only the configuration events or the unfixed errors for the given object type or object ID. Similarly, the last *x* entries against a given object type or object ID can be listed.

Note: Although an object type *unknown* is displayed in the error log, there is no available command to filter this object type.

Possible failures

- CMMVC5786E The action failed because the cluster is not in a stable state.
- CMMVC6252E The command failed authorization because the session SSH key is wrong or was deleted.
- CMMVC6253E The command failed authorization because the session SSH key does not have the requisite role.

An invocation example

```
svcinfo lserrlogbynode -delim :
```

The resulting output

```
id:type:fixed:SNMP_trap_raised:error_type:node_name:sequence_number:
root_sequence_number:first_timestamp:last_timestamp:number_of_errors:error_code
1:node:no:no:5:node1:0:0:030407082722:030407082722:1:00990501
1:node:no:no:5:node1:0:0:030407082716:030407082716:1:00990501
1:node:no:no:5:node1:0:0:030407052546:030407052546:1:00990383
0:node:no:no:6:node1:105:105:030407082202:030407082717:2:00980500
1:node:no:no:1:node1:102:102:030407052547:030407052547:1:00074001
```

lserrlogbyrconsistgrp

You can use the **lserrlogbyrconsistgrp** command to display the error log by Metro or Global Mirror consistency groups.

Syntax

```
svcinfo -- lserrlogbyrconsistgrp -- [-count number]
[-config] [-unfixed] [-nohdr] [-delim delimiter]
[rconsistgrp_id | rconsistgrp_name]
```

Parameters

-count *number*

(Optional) Specifies the maximum number of errors or events to list.

-config

(Optional) Lists only configuration events.

-unfixed

(Optional) Lists only unfixed errors.

-nohdr

(Optional) Suppresses the display of these headings. By default, headings are displayed for each column of data (in a concise style view providing general information about objects of a particular type) and for each item of data (in a detailed style view providing much more information about a specific object of a particular type).

Note: If there is no data to be displayed (for example, an empty view), headings are not displayed whether the **-nohdr** option was used or not.

-delim *delimiter*

(Optional) By default in a concise view, all columns of data are space-separated. The width of each column is set to the maximum possible width of each item of data. In a detailed view, each item of data has its own row, and if the headers are displayed, the data is separated from the header by a space. The **-delim** parameter overrides this behavior. Valid input for the **-delim** parameter is a one-byte character. If, for example, you entered **-delim :**, a colon separates all items of data in a concise view (for example, the spacing of columns does not occur) and in a detailed view the data is separated from its header by a colon.

rconsistgrp_id | rconsistgrp_name

(Optional) Specifies the object ID that filters the log.

Description

This command displays a list of the errors and events in the log by Metro or Global Mirror consistency groups. The list can be filtered further by specifying a specific object ID or name. This displays only the errors and events that have been logged against the specified object. The list can also be filtered to show only the

configuration events or the unfixed errors for the given object type or object ID. Similarly, the last *x* entries against a given object type or object ID can be listed.

Note: Although an object type *unknown* is displayed in the error log, there is no available command for this object type.

Possible failures

- CMMVC5786E The action failed because the cluster is not in a stable state.
- CMMVC6252E The command failed authorization because the session SSH key is wrong or was deleted.
- CMMVC6253E The command failed authorization because the session SSH key does not have the requisite role.

An invocation example

```
svcinfo lserrlogbyrconsistgrp -delim :
```

The resulting output

```
id:type:fixed:SNMP_trap_raised:error_type:node_name:sequence_number:
root_sequence_number:first_timestamp:last_timestamp:number_of_errors:error_code
253:rc_const_grp:no:no:5:node1:0:0:030407090333:030407090333:1:00990240
254:rc_const_grp:no:no:5:node1:0:0:030407090327:030407090327:1:00990240
255:rc_const_grp:no:no:5:node1:0:0:030407090323:030407090323:1:00990240
```

lserrlogbyrrelationship

The **lserrlogbyrrelationship** command displays a list of the errors and events in the log by to Metro or Global Mirror relationships.

Syntax

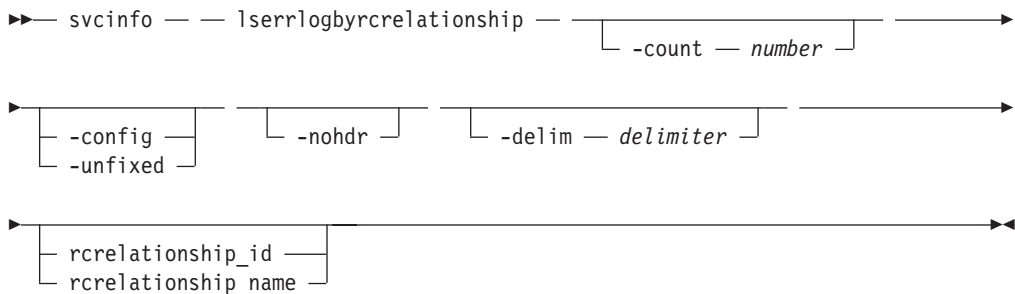

Parameters

- count *number***
(Optional) Specifies the maximum number of errors or events to list.
- config**
(Optional) Lists only configuration events.
- unfixed**
(Optional) Lists only unfixed errors.
- nohdr**
(Optional) Suppresses the display of these headings. By default, headings are displayed for each column of data (in a concise style view providing general

information about objects of a particular type) and for each item of data (in a detailed style view providing much more information about a specific object of a particular type).

Note: If there is no data to be displayed (for example, an empty view), headings are not displayed whether the **-nohdr** option was used or not.

-delim *delimiter*

(Optional) By default in a concise view, all columns of data are space-separated. The width of each column is set to the maximum possible width of each item of data. In a detailed view, each item of data has its own row, and if the headers are displayed, the data is separated from the header by a space. The **-delim** parameter overrides this behavior. Valid input for the **-delim** parameter is a one-byte character. If, for example, you entered **-delim ;**, a colon separates all items of data in a concise view (for example, the spacing of columns does not occur) and in a detailed view the data is separated from its header by a colon.

rrelationship_id | rrelationship_name

(Optional) Specifies the object ID that filters the log.

Description

This command displays a list of the errors and events in the log by Metro or Global Mirror relationships. The list can be filtered further by specifying a specific object ID or name. This displays only the errors and events that have been logged against the specified object. The list can also be filtered to show only the configuration events or the unfixed errors for the given object type or object ID. Similarly the last *x* entries against a given object type or object ID can be listed.

Note: Although an object type *unknown* is displayed in the error log, there is no available command to filter this object type.

Possible failures

- CMMVC5786E The action failed because the cluster is not in a stable state.
- CMMVC6252E The command failed authorization because the session SSH key is wrong or was deleted.
- CMMVC6253E The command failed authorization because the session SSH key does not have the requisite role.

An invocation example

```
svcinfo lserrlogbyrrelationship -delim :
```

The resulting output

```
id:type:fixed:SNMP_trap_raised:error_type:node_name:sequence_number:
root_sequence_number:first_timestamp:last_timestamp:number_of_errors:error_code
2:remote:no:no:5:node1:0:0:030407090442:030407090442:1:00990226
2:remote:no:no:5:node1:0:0:030407090106:030407090106:1:00990225
1:remote:no:no:5:node1:0:0:030407085932:030407085932:1:00990225
2:remote:no:no:6:n/a:106:106:030407090117:030407090117:1:00985002
```

lserrlogbyvdisk

The **lserrlogbyvdisk** command displays a list of the errors and events in the log by VDisks.

Syntax

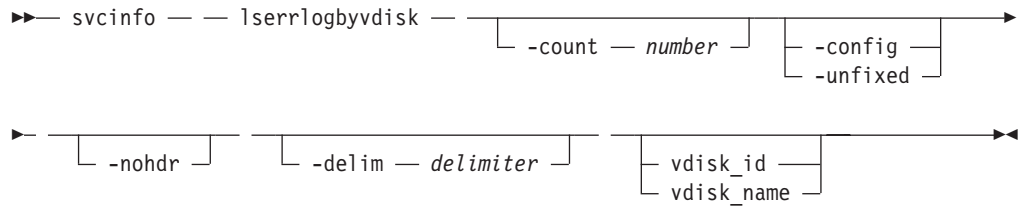

Parameters

-count *number*

(Optional) Specifies the maximum number of errors or events to list.

-config

(Optional) Lists only configuration events.

-unfixed

(Optional) Lists only unfixed errors.

-nohdr

(Optional) Suppresses the display of these headings. By default, headings are displayed for each column of data (in a concise style view providing general information about objects of a particular type) and for each item of data (in a detailed style view providing much more information about a specific object of a particular type).

Note: If there is no data to be displayed (for example, an empty view), headings are not displayed whether the **-nohdr** option was used or not.

-delim *delimiter*

(Optional) By default in a concise view, all columns of data are space-separated. The width of each column is set to the maximum possible width of each item of data. In a detailed view, each item of data has its own row, and if the headers are displayed, the data is separated from the header by a space. The **-delim** parameter overrides this behavior. Valid input for the **-delim** parameter is a one-byte character. If, for example, you entered **-delim ;**, a colon separates all items of data in a concise view (for example, the spacing of columns does not occur) and in a detailed view the data is separated from its header by a colon.

vdisk_id | **vdisk_name**

(Optional) Specifies the object ID that filters the log.

Description

This command displays a list of the errors and events in the log by VDisks. The list can be filtered further by specifying a specific object ID or name. This list displays only the errors and events that have been logged against the specified object. The list can also be filtered to show only the configuration events or the unfixed errors for the given object type or object ID. Similarly, the last *x* entries against a given object type or object ID can be listed.

Note: Although an object type *unknown* is displayed in the error log, there is no available command to filter this object type.

Possible failures

- CMMVC5786E The action failed because the cluster is not in a stable state.
- CMMVC6252E The command failed authorization because the session SSH key is wrong or was deleted.
- CMMVC6253E The command failed authorization because the session SSH key does not have the requisite role.

An invocation example

```
svcinfolerrlogbyvdisk -delim :
```

The resulting output

```
id:type:fixed:SNMP_trap_raised:error_type:node_name:sequence_number:
root_sequence_number:first_timestamp:last_timestamp:number_of_errors:error_code
3:vdisk:no:no:5:node1:0:0:030407090825:030407090825:1:00990182
1:vdisk:no:no:5:node1:0:0:030407090820:030407090820:1:00990182
4:vdisk:no:no:5:node1:0:0:030407090013:030407090013:1:00990169
3:vdisk:no:no:5:node1:0:0:030407090004:030407090004:1:00990169
2:vdisk:no:no:5:node1:0:0:030407085959:030407085959:1:00990169
1:vdisk:no:no:5:node1:0:0:030407082213:030407082213:1:00990169
0:vdisk:no:no:5:node1:0:0:030407082158:030407082158:1:00990169
0:vdisk:no:no:5:node1:0:0:030407082148:030407082148:1:00990169
0:vdisk:no:no:5:node1:0:0:030407082145:030407082145:1:00990169
0:vdisk:no:no:5:node1:0:0:030407082015:030407082015:1:00990169
0:vdisk:no:no:5:node1:0:0:030407081854:030407081854:1:00990169
1:vdisk:no:no:5:node1:0:0:030407081843:030407081843:1:00990169
0:vdisk:no:no:5:node1:0:0:030407081836:030407081836:1:00990169
```

lserrlogdumps

The **lserrlogdumps** commands display a list of error log dumps in the `/dumps/elogs` directory. These dumps are created as a result of the **svctask dumperrlog** command.

Syntax

```
svcinfolerrlogdumps [-nohdr] [-delim delimiter] [node_id node_name]
```

Parameters

-nohdr

(Optional) Suppresses the display of these headings. By default, headings are displayed for each column of data (in a concise style view providing general information about objects of a particular type) and for each item of data (in a detailed style view providing much more information about a specific object of a particular type).

Note: If there is no data to be displayed (for example, an empty view), headings are not displayed whether the **-nohdr** option was used or not.

-delim delimiter

(Optional) By default in a concise view, all columns of data are space-separated. The width of each column is set to the maximum possible

width of each item of data. In a detailed view, each item of data has its own row, and if the headers are displayed, the data is separated from the header by a space. The **-delim** parameter overrides this behavior. Valid input for the **-delim** parameter is a one-byte character. If, for example, you entered **-delim ;**, a colon separates all items of data in a concise view (for example, the spacing of columns does not occur) and in a detailed view the data is separated from its header by a colon.

node_id | node_name

(Optional) Specifies the node ID or name to list the available dumps of the given type. If you do not specify a node, the dumps that are available on the configuration node are listed.

Description

This command displays a list of error log dumps. These dumps are created as a result of the **svctask dumperrlog** command. An error log dump describes the contents of the error log at the time that the command was issued. If you do not specify a node, the dumps that are available on the configuration node are listed. The command displays files from the **/dumps/elogs** directory.

Possible failures

- CMMVC5786E The action failed because the cluster is not in a stable state.
- CMMVC6252E The command failed authorization because the session SSH key is wrong or was deleted.
- CMMVC6253E The command failed authorization because the session SSH key does not have the requisite role.

An invocation example

```
svcinfo lserrlogdumps
```

The resulting output

```
id          filename
0           errlog_lynn02_030327_154511
1           aaa.txt_lynn02_030327_154527
2           aaa.txt_lynn02_030327_154559
3           errlog_lynn02_030403_110628
```

lsfabric

The **lsfabric** command generates a report that displays the connectivity between nodes and other controllers and hosts.

Syntax

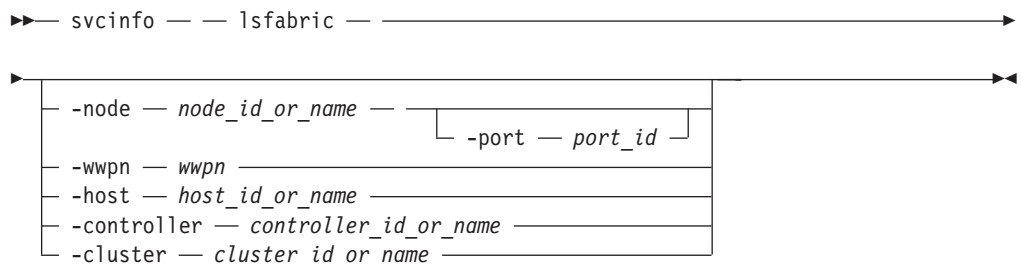

Parameters

-node *node_id_or_name*

(Optional) Specifies that you want to display the output for all ports of a specified node. You cannot use the **-node** parameter with any of the other parameters in this command except the **-port** parameter.

-port *port_id*

(Optional) Specifies a port ID. An optional parameter that can only be used together with the **-node** parameter. When the **-port** parameter is used with the **-node** parameter, a report is generated that displays a concise view of all the WWPNs that are currently logged into the designated node and port. Valid data is a number in the range 1 - 4 that matches the port with the same number in the vital product data (VPD) or the actual hexadecimal WWPN of the local port.

-wwpn *wwpn*

(Optional) Specifies that you want to view a report that displays a list of all ports that have a login to the specified WWPN. You cannot use the **-wwpn** parameter with any other parameter in this command.

-host *host_id_or_name*

(Optional) Specifies a host name or ID. Issuing the **lsfabric** command with the **-host** parameter is equivalent to issuing the **svcinfo lsfabric -wwpn wwpn** command for every configured WWPN of the specified host. For example, a host with 2 ports that are zoned to 1 port of every node in a 8 node cluster produces 16 lines of output. You cannot use the **-host** parameter with any other parameter in this command.

-controller *controller_id_or_name*

(Optional) Specifies a controller ID or name. You cannot use the **-controller** parameter with any other parameter in this command. Issuing the **lsfabric** command with the **-controller** parameter is equivalent to issuing the **svcinfo lsfabric -wwpn wwpn** command for every configured WWPN of the specified controller. For example, a controller with 4 ports connected to a 8 node cluster with 2 counter part SANs produces 64 lines of output.

-cluster *cluster_id_or_name*

(Optional) Specifies a cluster ID or name. You cannot use the **-cluster** parameter with any other parameter in this command. Issuing the **lsfabric** command with the **-cluster** parameter is equivalent to issuing the **svcinfo lsfabric -wwpn wwpn** command for every known WWPN in the specified cluster. Output is sorted by remote WWPNs and then cluster WWPNs. This command can be used to check the state of connections within the local cluster or between the local and remote cluster. When the local cluster ID or name is specified, each node-to-node connection is listed twice: once from each end. For example, an 8 node cluster with 2 counter part SANs produces 8 nodes x 7 other nodes x 2 SANs x 4 point-to-point logins = 448 lines of output.

Description

This command can be issued with any of the parameters as described above in order to display a limited subset of information.

If the command is issued without any parameters, it provides output for every node.

Values for the type and state fields are:

state active

This value means the following depending on the item you are dealing with:

- **host** - SCSI commands were issued within the last 5 minutes.
- **node** - node ports can see other ports.
- **controllers** - commands were issued within the last 10 seconds.

state inactive

No transactions have completed within the last 5 minutes.

type One of the following values is displayed: host/node/controller/node/unknown

You can issue this command if you want to view all the information about the connections available to your cluster.

Possible failures

- CMMVC5786E The action failed because the cluster is not in a stable state.
- CMMVC5804E The action failed because an object that was specified in the command does not exist.
- CMMVC6252E The command failed authorization because the session SSH key is wrong or was deleted.
- CMMVC6253E The command failed authorization because the session SSH key does not have the requisite role.

An invocation example

```
svcinfo lsfabric -delim :
```

The resulting output Each row of output will contain the following columns:

```
remote_wwpn: remote_nportid:
local_wwpn: local_port:
local_nportid: state: name: type
```

lsfcconsistgrp

The **lsfcconsistgrp** command returns a concise list or a detailed view, of FlashCopy consistency groups visible to the cluster. This information is useful for tracking FlashCopy consistency groups.

The list report style can be used to obtain two styles of report.

1. A list containing concise information about all the FlashCopy consistency groups on a cluster. (Each entry in the list corresponds to a single FlashCopy consistency group.)
2. The detailed information about a single FlashCopy consistency group.

Syntax

```

▶▶▶ svcinfo — — lsfcconsistgrp — —————▶
                                   └── -filtervalue — attrib=value ─┘
▶ ┌── -nohdr ─┘ ┌── -delim — delimiter ─┘ ┌── object_id ─┘
                                   └── name ─┘

```

└─ filtervalue? ─┘

Parameters

-filtervalue *attribute=value*

(Optional) Specifies a list of one or more filters. Only objects with a value that matches the filter attribute value are returned. If a capacity is specified, the units must also be included.

Note: Some filters allow the use of a wildcard when entering the command. The following rules apply to the use of wildcards with the SAN Volume Controller CLI:

- The wildcard character is an asterisk (*).
- The command can contain a maximum of one wildcard.
- When using a wildcard, it is important to surround that filter entry with double quotes like the following display:

```
>svcinfolsfconsistgrp -filtervalue "name=md*"
```

-nohdr

(Optional) By default, headings are displayed for each column of data (in a concise style view) and each item of data (in a detailed style view). The **-nohdr** parameter suppresses the display of these headings.

Note: If there is no data to be displayed (for example, an empty view has been returned), then headings are not displayed irrespective of whether the **-nohdr** option was used or not.

-delim *delimiter*

(Optional) By default in a concise view, all columns of data are space-separated. The width of each column is set to the maximum possible width of each item of data. In a detailed view, each item of data has its own row, and if the headers are displayed the data is separated from the header by a space. The **-delim** parameter overrides this behavior. Valid input for the **-delim** parameter is a one byte character. If you enter **-delim :** on the command line, a colon is used to separate all items of data in a concise view; the spacing of columns does not occur. In a detailed view, the data is separated from its header by a colon.

object_id | name

(Optional) Specifies the name or ID of an object. When you use this parameter, the detailed view of the specific object is returned and any value that is specified by the **-filtervalue** parameter is ignored. If you do not specify the **-object_ID** or **object_name** parameter, the concise view of all objects matching the filtering requirements that is specified by the **-filtervalue** parameter are displayed.

-filtervalue?

(Optional) Specifies that you want your report to display any or all of the list of valid filter attributes. The valid filter attributes for the **svcinfolsfconsistgrp** command are:

- name
- FC_group_id
- status
- id

Description

This command returns a concise list or a detailed view, of FlashCopy consistency groups visible to the cluster.

The following list provides possible values that are applicable to the attributes that are displayed as data in the output views:

status idle_or_copied, preparing, prepared, copying, stopped, suspended,
and stopping

Possible failures

- CMMVC5786E The action failed because the cluster is not in a stable state.
- CMMVC5804E The action failed because an entity that was specified in the command does not exist.
- CMMVC6252E The command failed authorization because the session SSH key is wrong or was deleted.
- CMMVC625 3E The command failed authorization because the session SSH key does not have the requisite role.

A concise invocation example

```
svcinfo lsfcconsistgrp -delim :
```

The concise resulting output

```
id:name:status  
1:ffccg0:idle_or_copied  
2:ffccg1:idle_or_copied  
3:ffccg2:idle_or_copied
```

A detailed invocation example

```
svcinfo lsfcconsistgrp -delim : 1
```

The detailed resulting output

```
id:1  
name:ffccg0  
status:idle_or_copied
```

lsfcmap

The **lsfcmap** command generates a list containing concise information about all FlashCopy mappings visible to the cluster, or detailed information for a single FlashCopy mapping.

The list report can generate two styles of report.

1. A list containing concise information about all FlashCopy mappings visible to the cluster. (Each entry in the list corresponds to a single FlashCopy mapping.)
2. The detailed information about a single FlashCopy Mapping.

Syntax

```
➤➤ svcinfo — — lsfcmap — — [ -filtervalue — attrib=value ] — ➤➤
```

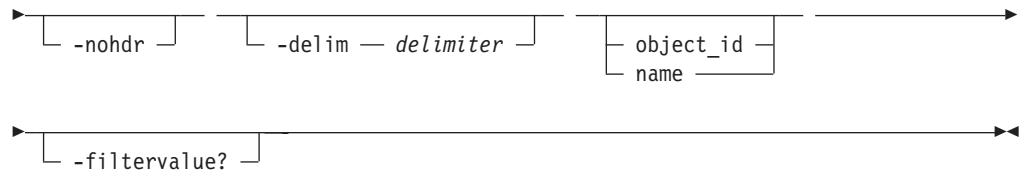

Parameters

-filtervalue *attribute=value*

(Optional) Specifies a list of one or more filters. Only objects with a value that matches the filter attribute value are returned. If a capacity is specified, the units must also be included.

Note: Some filters allow the use of a wildcard when entering the command. The following rules apply to the use of wildcards with the SAN Volume Controller CLI:

- The wildcard character is an asterisk (*).
- The command can contain a maximum of one wildcard.
- When using a wildcard, it is important to surround that filter entry with double quotes like the following display:

```
>svcinfolsfcmapp-filtervalue "name=md*"
```

-nohdr

(Optional) By default, headings are displayed for each column of data (in a concise style view) and each item of data (in a detailed style view). The **-nohdr** parameter suppresses the display of these headings.

Note: If there is no data to be displayed (an empty view), headings are not displayed even if the **-nohdr** parameter is used.

-delim *delimiter*

(Optional) By default in a concise view, all columns of data are space-separated. The width of each column is set to the maximum possible width of each item of data. In a detailed view, each item of data has its own row, and if the headers are displayed the data is separated from the header by a space. The **-delim** parameter overrides this behavior. Valid input for the **-delim** parameter is a one-byte character. If you enter `-delim :` on the command line, a colon separates all items of data in a concise view; the spacing of columns does not occur. In a detailed view, the data is separated from its header by a colon.

object_id | name

(Optional) Specifies the name or ID of an object. When you use this parameter, the detailed view of the specific object is returned and any value that is specified by the **-filtervalue** parameter is ignored. If you do not specify the **-object_ID** or **object_name** parameter, the concise view of all objects matching the filtering requirements that is specified by the **-filtervalue** parameter are displayed.

-filtervalue?

(Optional) Specifies that you want your report to display any or all of the list of valid filter attributes. The valid filter attributes for the **svcinfolsfcmapp** command are:

- FC_mapping_name
- FC_id

- source_vdisk_id
- source_vdisk_name
- target_vdisk_id
- target_vdisk_name
- group_name
- group_id
- progress
- copy_rate

Description

This command returns a concise list or a detailed view, of FlashCopy mappings visible to the cluster.

The following list provides possible values that are applicable to the attributes that are displayed as data in the output views:

status idle_or_copied, preparing, prepared, copying, stopped, suspended or stopping

start_time
displays the time in the format, YYMMDDHHMMSS that the copy was last started. If the copy has never been started, a blank line is displayed

Possible failures

- CMMVC5786E The action failed because the cluster is not in a stable state.
- CMMVC5804E The action failed because an entity that was specified in the command does not exist.
- CMMVC6252E The command failed authorization because the session SSH key is wrong or was deleted.
- CMMVC6253E The command failed authorization because the session SSH key does not have the requisite role.

A concise invocation example

```
svcinfo lsfcmap -delim :
```

The concise resulting output

```
id:name:source_vdisk_id:source_vdisk_name:target_vdisk_id:
target_vdisk_name:group_id:group_name:status:progress:copy_rate
0:ffcmapi:0:vdisk0:1:vvdisktwo:::idle_or_copied::75
```

A detailed invocation example

```
svcinfo lsfcmap -delim : 0
```

The detailed resulting output

```
id:0
name:fcmap0
source_vdisk_id:0
source_vdisk_name:vdisk0
target_vdisk_id:1
target_vdisk_name:vdisk1
group_id:
group_name:
status:idle_or_copied
progress:100
```



```
copy_rate:50
start_time:061026110258
dependent_mappings_count:0
autodelete:off
```

lsfcmapcandidate

The **lsfcmapcandidate** command lists all the VDisks that can be source or target destinations for FlashCopy mappings. It can also be used to list all VDisks that are not already in a mapping. If you do not use the **-source** or **-target** parameters with this command, the command is processed as though you specified the **-target** parameter.

Syntax

```
▶▶ svcinfo — lsfcmapcandidate — [ -source ] [ -target ]
[ -nohdr ] [ -delim delimiter ] ▶▶
```

Parameters

-source

(Optional) Specifies that you want the report to display the VDisks that are candidates for being the source of a copy.

Note: The VDisks displayed in the report when using the **-source** parameter are the source disk in 0 or more, but less than, 16 FlashCopy mappings.

-target

(Optional) Specifies that you want the report to display the VDisks that are candidates for being the target of a copy.

Note: The VDisks displayed in the report when using the **-target** parameter are not involved in any FlashCopy mappings. A VDisk can only be the target in one FlashCopy mapping.

-nohdr

(Optional) By default, headings are displayed for each column of data (in a concise style view) and each item of data (in a detailed style view). The **-nohdr** parameter suppresses the display of these headings.

Note: If there is no data to be displayed (for example, an empty view has been returned), then headings are not displayed irrespective of whether the **-nohdr** option was used or not.

-delim *delimiter*

(Optional) By default in a concise view, all columns of data are space-separated. The width of each column is set to the maximum possible width of each item of data. In a detailed view, each item of data has its own row, and if the headers are displayed the data is separated from the header by a space. The **-delim** parameter overrides this behavior. Valid input for the **-delim** parameter is a one byte character. If you enter **-delim :** on the command line, a colon is used to separate all items of data in a concise view; the spacing of columns does not occur. In a detailed view, the data is separated from its header by a colon.

Description

This command returns a list of VDisks that are not in a FlashCopy mapping when the **-source** and **-target** parameters are not specified. If the **-source** parameter is specified a list of VDisk IDs that are candidates for being the source of a copy is returned. If the **-target** parameter is specified a list of VDisk IDs that are candidates for being the target of a copy are returned.

Possible failures

- CMMVC5786E The action failed because the cluster is not in a stable state.
- CMMVC5804E The action failed because an entity that was specified in the command does not exist.
- CMMVC6252E The command failed authorization because the session SSH key is wrong or was deleted.
- CMMVC6253E The command failed authorization because the session SSH key does not have the requisite role.

An invocation example

```
svcinfo lsfcmapcandidate
```

The resulting output

```
id  
2  
3  
4
```

lsfcmapprogress

The **lsfcmapprogress** command returns the progress of the background copy of a FlashCopy mapping. This is displayed as a percentage completed value.

Syntax

```
▶▶ svcinfo — — lsfcmapprogress — — [ -nohdr ] —————▶  
  
▶ [ -delim — delimiter ] [ fcmapping_id fcmapping_name ] —————▶
```

Parameters

-nohdr

(Optional) By default, headings are displayed for each column of data (in a concise style view) and each item of data (in a detailed style view). The **-nohdr** parameter suppresses the display of these headings.

Note: If there is no data to be displayed (for example, an empty view has been returned), then headings are not displayed irrespective of whether the **-nohdr** option was used or not.

-delim *delimiter*

(Optional) By default in a concise view, all columns of data are space-separated. The width of each column is set to the maximum possible width of each item of data. In a detailed view, each item of data has its own row, and if the headers are displayed the data is separated from the header by

a space. The **-delim** parameter overrides this behavior. Valid input for the **-delim** parameter is a one byte character. If you enter **-delim :** on the command line, a colon is used to separate all items of data in a concise view; the spacing of columns does not occur. In a detailed view, the data is separated from its header by a colon.

fcmap_id | fcmap_name

(Required) Specifies that you want the report to display the progress of the background copy for the designated FlashCopy mapping.

Description

This command reports a percentage for the progress of the background copy being done on the specified FlashCopy mapping.

Possible failures

- CMMVC5786E The action failed because the cluster is not in a stable state.
- CMMVC5804E The action failed because an entity that was specified in the command does not exist.
- CMMVC5805E The progress information was not returned because the FlashCopy statistics are not ready yet.
- CMMVC6252E The command failed authorization because the session SSH key is wrong or was deleted.
- CMMVC6253E The command failed authorization because the session SSH key does not have the requisite role.

An invocation example

```
svcinfo lsfcmapprogress 0
```

The resulting output

```
id          progress
0           0
```

lsfcmapdependentmaps

The **lsfcmapdependentmaps** command displays all the FlashCopy mappings that are dependent on the user specified mapping.

Syntax

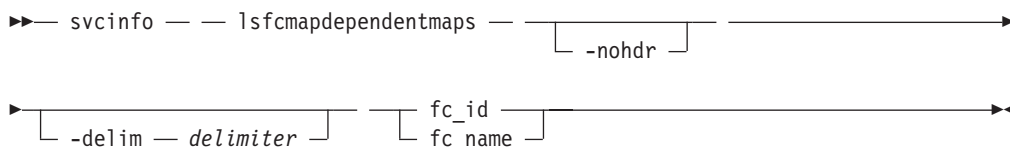

Parameters

-nohdr

(Optional) By default, headings are displayed for each column of data (in a concise style view) and each item of data (in a detailed style view). The **-nohdr** parameter suppresses the display of these headings.

Note: If there is no data to be displayed (for example, an empty view has been returned), then headings are not displayed irrespective of whether the **-nohdr** option was used or not.

-delim *delimiter*

(Optional) By default in a concise view, all columns of data are space-separated. The width of each column is set to the maximum possible width of each item of data. In a detailed view, each item of data has its own row, and if the headers are displayed the data is separated from the header by a space. The **-delim** parameter overrides this behavior. Valid input for the **-delim** parameter is a one byte character. If you enter **-delim :** on the command line, a colon is used to separate all items of data in a concise view; the spacing of columns does not occur. In a detailed view, the data is separated from its header by a colon.

fc_id | fc_name

(Required) Specifies the name or ID of the FlashCopy mapping that you want to list the dependent maps for.

Note: The value for this parameter is not included in the list of dependent mappings. However, the list is displayed in dependency order, so that the last entry in the list is the bottom member of the dependency list (or the first copy that was started).

Description

This command returns a list of dependent FlashCopy mappings. This command can be used to determine the list of FlashCopy mappings that would also stop if you stopped a mapping using the **-force** parameter.

There is a `dependent_mapping_count` field in the FlashCopy map detailed view (displayed when you process the **lsfcmap** command) that you can use as an indicator as to whether there are any dependent mappings in progress. If the count is zero, there are no dependent copies.

Note: If a period time elapses between the time you process the **lsfcmap** command and the **lsfcmapdependentmaps** command, there could be a difference between the actual number of dependent mappings being processed and the number that was reported by the **lsfcmap** command.

A concise invocation example

```
svcinfo lsfcmapdependentmaps -delim : 2
```

The resulting output

```
fc_id:fc_name  
1:fcmap1  
3:fcmap3
```

lsfeaturedumps

The **lsfeaturedumps** command displays a list of dump files in the `/dumps/feature` directory. These dump files are created as a result of the **svctask dumpinternallog** command.

Syntax

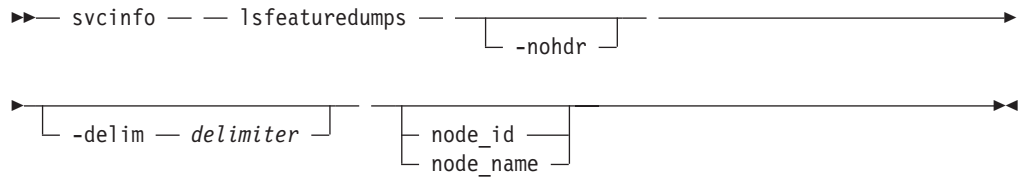

Parameters

-nohdr

(Optional) Suppresses the display of these headings. By default, headings are displayed for each column of data (in a concise style view providing general information about objects of a particular type) and for each item of data (in a detailed style view providing much more information about a specific object of a particular type).

Note: If there is no data to be displayed (for example, an empty view), headings are not displayed whether the **-nohdr** option was used or not.

-delim *delimiter*

(Optional) By default in a concise view, all columns of data are space-separated. The width of each column is set to the maximum possible width of each item of data. In a detailed view, each item of data has its own row, and if the headers are displayed, the data is separated from the header by a space. The **-delim** parameter overrides this behavior. Valid input for the **-delim** parameter is a one-byte character. If, for example, you entered **-delim ;**, a colon separates all items of data in a concise view (for example, the spacing of columns does not occur) and in a detailed view the data is separated from its header by a colon.

node_id | **node_name**

(Optional) Specifies the node ID or node name to list the available dumps of the given type. If you do not specify a node, the dumps that are available on the configuration node are listed.

Description

This command displays a list of featurization dumps. These dumps are created as a result of issuing the **svctask dumpinternallog** command. A featurization dump file describes the contents of the featurization log at the time that the command was issued. If you do not specify a node, the dumps that are available on the configuration node are listed. The command displays files from the `/dumps/feature` directory.

Issue the **svcinfo lsfeaturedumps** command to display a list of dumps in the `/dumps/feature` destination directory. The feature log is maintained by the cluster. The feature log records events that are generated when license parameters are entered or when the current license settings have been breached.

Possible failures

- CMMVC5786E The action failed because the cluster is not in a stable state.
- CMMVC6252E The command failed authorization because the session SSH key is wrong or was deleted.

- CMMVC6253E The command failed authorization because the session SSH key does not have the requisite role.

An invocation example

```
svcinfo lsfeaturedumps
```

The resulting output

```
id          feature_filename
0           feature.txt
```

lsfreeextents

The **lsfreeextents** command lists the number of free extents that are available on a specified MDisk.

Syntax

```
svcinfo -- lsfreeextents -- [ -nohdr ]
```

Parameters

-nohdr

(Optional) Suppresses the display of these headings. By default, headings are displayed for each column of data (in a concise style view providing general information about objects of a particular type) and for each item of data (in a detailed style view providing much more information about a specific object of a particular type).

Note: If there is no data to be displayed (for example, an empty view), headings are not displayed whether the **-nohdr** option was used or not.

-delim delimiter

(Optional) By default in a concise view, all columns of data are space-separated. The width of each column is set to the maximum possible width of each item of data. In a detailed view, each item of data has its own row, and if the headers are displayed, the data is separated from the header by a space. The **-delim** parameter overrides this behavior. Valid input for the **-delim** parameter is a one-byte character. If, for example, you entered **-delim :**, a colon separates all items of data in a concise view (for example, the spacing of columns does not occur) and in a detailed view the data is separated from its header by a colon.

mdisk_id | mdisk_name

(Required) Specifies the ID or the name of the MDisk for which you want to know the number of free extents.

Description

This command displays a count of the number of free extents on the specified MDisk.

Possible failures

- CMMVC5786E The action failed because the cluster is not in a stable state.
- CMMVC5804E The action failed because an entity that was specified in the command does not exist.
- CMMVC6252E The command failed authorization because the session SSH key is wrong or was deleted.
- CMMVC6253E The command failed authorization because the session SSH key does not have the requisite role.

An invocation example

```
svcinfo lsfreeextents 2
```

The resulting output

```
id 2  
number_of_extents 4372
```

Ishbaportcandidate

The **Ishbaportcandidate** command lists all of the unconfigured, logged in host bus adapter (HBA) ports. This information is used to find open HBA ports.

Syntax

```
▶▶▶ svcinfo — — lshbaportcandidate — ————▶  
└── -nohdr ─┘  
▶────────────────────────────────────────▶▶  
└── -delim — delimiter ─┘
```

Parameters

-nohdr

(Optional) By default, headings are displayed for each column of data (in a concise style view) and each item of data (in a detailed style view). The **-nohdr** parameter suppresses the display of these headings.

Note: If there is no data to be displayed (for example, in an empty), then headings are not displayed irrespective of whether the **-nohdr** parameter was used or not.

-delim delimiter

(Optional) By default in a concise view, all columns of data are space-separated. The width of each column is set to the maximum possible width of each item of data. In a detailed view, each item of data has its own row, and if the headers are displayed the data is separated from the header by a space. The **-delim** parameter overrides this behavior. Valid input for the **-delim** parameter is a one byte character. If you enter **-delim :** on the command line, a colon is used to separate all items of data in a concise view; the spacing of columns does not occur. In a detailed view, the data is separated from its header by a colon.

Description

This command returns a list of unconfigured, logged in HBA ports.

Note: The `svcinfo lshbaportcandidate` command presents a list of host HBA ports that are logged in to nodes. However, there are situations when the information that is presented might include host HBA ports that are no longer logged in or even part of the SAN fabric. For example, a host HBA port is unplugged from a switch but `svcinfo lshbaportcandidate` still shows the WWPN that is logged in to all nodes. If this occurs, the incorrect entry is removed when another device is plugged in to the same switch port that previously contained the removed host HBA port.

Possible failures

- CMMVC5786E The action failed because the cluster is not in a stable state.
- CMMVC5804E The action failed because an entity that was specified in the command does not exist.

An invocation example

```
svcinfo lshbaportcandidate
```

The resulting output

```
id
210100E08B2520D4
```

lshost

The `lshost` command generates a list with concise information about all the hosts visible to the cluster and detailed information about a single host.

The list report style can be used to obtain two styles of report.

1. A list containing concise information about all the hosts visible to the cluster. Each entry in the list corresponds to a single host.
2. The detailed information about a single host.

Syntax

```

>> svcinfo -- lshost [ -filtervalue -- attrib=value ]
[ -nohdr ] [ -delim -- delimiter ] [ object_id ]
[ name ]
[ -filtervalue? ]

```

Parameters

-filtervalue *attribute=value*

(Optional) Specifies a list of one or more filters. Only objects with a value that matches the filter attribute value are returned. If a capacity is specified, the units must also be included.

Note: Some filters allow the use of a wildcard when entering the command. The following rules apply to the use of wildcards with the SAN Volume Controller CLI:

- The wildcard character is an asterisk (*).

- The command can contain a maximum of one wildcard.
- When using a wildcard, it is important to surround that filter entry with double quotes like the following display:

```
>svcinfolshost -filtervalue "name=md*"
```

-nohdr

(Optional) By default, headings are displayed for each column of data (in a concise style view) and each item of data (in a detailed style view). The **-nohdr** parameter suppresses the display of these headings.

Note: If there is no data to be displayed (for example, an empty view has been returned), then headings are not displayed irrespective of whether the **-nohdr** option was used or not.

-delim *delimiter*

(Optional) By default in a concise view, all columns of data are space-separated. The width of each column is set to the maximum possible width of each item of data. In a detailed view, each item of data has its own row, and if the headers are displayed the data is separated from the header by a space. The **-delim** parameter overrides this behavior. Valid input for the **-delim** parameter is a one byte character. If you enter **-delim :** on the command line, a colon is used to separate all items of data in a concise view; the spacing of columns does not occur. In a detailed view, the data is separated from its header by a colon.

object_id | name

(Optional) Specifies the name or ID of an object. When you use this parameter, the detailed view of the specific object is returned and any value that is specified by the **-filtervalue** parameter is ignored. If you do not specify the **-object_ID** or **-object_name** parameter, the concise view of all objects matching the filtering requirements that is specified by the **-filtervalue** parameter are displayed.

-filtervalue?

(Optional) Specifies that you want your report to display any or all of the list of valid filter attributes. The valid filter attributes for the **svcinfolshost** command are:

- host_name
- host_id
- port_count
- name
- id
- iogrp_count

Description

This command returns a concise list or a detailed view, of hosts visible to the cluster.

The following list provides the different states for a host:

offline

The host is offline if one or more I/O groups with VDisk mappings does not have a login for the specified WWPN.

degraded

The host is degraded if one or more nodes with VDisk mappings do not have a login for the specified WWPN.

inactive

The host is inactive if all the nodes with VDisk mappings have a login for the specified WWPN, however, no nodes have seen any SCSI commands from the WWPN in the last 5 minutes.

active The host is active if all the nodes with VDisk mappings have a login for the specified WWPN, however, at least one node has seen SCSI commands from the WWPN in the last 5 minutes.

If a host does not have any VDisk mappings, then it is either reported as offline or inactive.

Note: The **svcinfo lshost** command presents a list of host HBA ports that are logged in to nodes. However, there are situations when the information presented can include host HBA ports which are no longer logged in or even part of the SAN fabric. For example: A host HBA port is unplugged from a switch but **svcinfo lshost** still shows the WWPN logged in to all nodes. If this occurs, the incorrect entry is removed when another device is plugged in to the same switch port that previously contained the removed host HBA port.

Possible failures

- CMMVC5786E The action failed because the cluster is not in a stable state.
- CMMVC5804E The action failed because an entity that was specified in the command does not exist.
- CMMVC6252E The command failed authorization because the session SSH key is wrong or was deleted.
- CMMVC6253E The command failed authorization because the session SSH key does not have the requisite role.

A concise invocation example

```
svcinfo lshost -delim :
```

The concise resulting output

```
id:name:port_count:iogrp_count
0:host0:1:0
1:host1:1:0
```

A detailed invocation example

```
svcinfo lshost -delim : 1
```

The detailed resulting output

```
id:1
name:host1
port_count:1
type:generic
iogrp_count:0
mask:1111
WWPN:000000000001AABB
node_logged_in_count:0
state:inactive
```

lshostigrp

The **lshostigrp** command displays a list of all the I/O groups that are associated with a specified host.

Syntax

```
svcinfo lshostigrp [-nohdr] [-delim delimiter] host_id_or_name
```

Parameters

-nohdr

(Optional) Suppresses the display of these headings. By default, headings are displayed for each column of data (in a concise style view providing general information about objects of a particular type) and for each item of data (in a detailed style view providing much more information about a specific object of a particular type).

Note: If there is no data to be displayed (for example, an empty view), headings are not displayed whether the **-nohdr** option was used or not.

-delim delimiter

(Optional) By default in a concise view, all columns of data are space-separated. The width of each column is set to the maximum possible width of each item of data. In a detailed view, each item of data has its own row, and if the headers are displayed, the data is separated from the header by a space. The **-delim** parameter overrides this behavior. Valid input for the **-delim** parameter is a one-byte character. If, for example, you entered **-delim :**, a colon separates all items of data in a concise view (for example, the spacing of columns does not occur) and in a detailed view the data is separated from its header by a colon.

host_id_or_name

(Required) The name or ID of the host for which the list of I/O groups is required.

Description

This command displays a list of all the I/O groups that are mapped to the specified host.

Possible failures

- CMMVC5786E The action failed because the cluster is not in a stable state.
- CMMVC5804E The action failed because an object that was specified in the command does not exist.
- CMMVC6252E The command failed authorization because the session SSH key is wrong or was deleted.
- CMMVC6253E The command failed authorization because the session SSH key does not have the requisite role.

An invocation example

```
svcinfo lshostigrp -delim : hostone
```

The resulting output

```
id:name
0:io_grp0
1:io_grp1
```

lshostvdiskmap

You can use the **lshostvdiskmap** command to obtain a list of the virtual disks that are mapped (recognized by) to a given host. These are the virtual disks that have been mapped to the specified host, meaning they are recognized by the specified host.

Syntax

```
svcinfolshostvdiskmap [-nohdr] [-delim delimiter] [host_id | host_name]
```

Parameters

-nohdr

(Optional) Suppresses the display of these headings. By default, headings are displayed for each column of data (in a concise style view providing general information about objects of a particular type) and for each item of data (in a detailed style view providing much more information about a specific object of a particular type).

Note: If there is no data to be displayed (for example, an empty view), headings are not displayed whether the **-nohdr** option was used or not.

-delim *delimiter*

(Optional) By default in a concise view, all columns of data are space-separated. The width of each column is set to the maximum possible width of each item of data. In a detailed view, each item of data has its own row, and if the headers are displayed, the data is separated from the header by a space. The **-delim** parameter overrides this behavior. Valid input for the **-delim** parameter is a one-byte character. If, for example, you entered **-delim ;**, a colon separates all items of data in a concise view (for example, the spacing of columns does not occur) and in a detailed view the data is separated from its header by a colon.

host_id | host_name

(Optional) Specifies the host in terms of its ID or name. The command displays a list of all the virtual disks that are mapped to the specified host and the SCSI ID by which they are mapped. If neither a host ID or name are entered, the command displays a list of all recognized host-to-VDisk mappings.

Description

This command displays a list of virtual disk IDs and names. These are the virtual disks that have been mapped to the specified host; that is, they are visible to the specified host. The SCSI LUN ID is also displayed. This SCSI LUN ID is the ID by which the virtual disk is recognized by the host.

Determining the VDisk name from the vpath number on the host: Each VDisk that is exported by the cluster is assigned a unique vpath number. This number identifies the VDisk and determines which VDisk corresponds to the volume that the hosts recognize. This procedure can only be performed using the command-line interface.

For the specified volume, find the vpath serial number by issuing the **datapath query device** command. Find the host that is defined to the cluster that corresponds with the host that you are working with.

1. The WWPNs are an attribute of the HBA. You can find these by looking at the device definitions stored by your operating system. For example, on AIX they are in the ODM, in Windows they are in the Device Manager details for the given HBA.
2. Verify which host is defined to the cluster that these ports belong to. The ports are stored as part of the detailed view, so you must list each host in turn by issuing the following command:

```
svcinfolshost <name/id>
```

where *<name/id>* is the name or ID of the host. Check for matching WWPNs.

Note: Name your hosts accordingly. For example, if the actual host is called *orange*, also name the host that is defined to the cluster *orange*.

When you have the *<host name>* defined to the cluster and the *<vpath serial number>*, issue the following command:

```
svcinfolshostvdiskmap <hostname>
```

where *<hostname>* is the name of the host. A list is displayed. Look for the VDisk UID that matches the *<vpath serial number>* and record the VDisk name or ID.

Possible failures

- CMMVC5786E The action failed because the cluster is not in a stable state.
- CMMVC5804E The action failed because an entity that was specified in the command does not exist.
- CMMVC6252E The command failed authorization because the session SSH key is wrong or was deleted.
- CMMVC6253E The command failed authorization because the session SSH key does not have the requisite role.

An invocation example

```
svcinfolshostvdiskmap -delim : 2
```

The resulting output

```
id:name:SCSI_id:vdisk_id:vdisk_name:wwpn:vdisk_UID
2:host2:0:10:vdisk10:0000000000000000ACA:6005076801958001500000000000000A
2:host2:1:11:vdisk11:0000000000000000ACA:6005076801958001500000000000000B
2:host2:2:12:vdisk12:0000000000000000ACA:6005076801958001500000000000000C
2:host2:3:13:vdisk13:0000000000000000ACA:6005076801958001500000000000000D
2:host2:4:14:vdisk14:0000000000000000ACA:6005076801958001500000000000000E
```

lsiogrp

The **lsiogrp** command returns a concise list or a detailed view, of I/O groups visible to the cluster.

The list report style can be used to obtain two styles of report.

1. A list containing concise information about all the I/O groups visible to the cluster. (Each entry in the list corresponds to a single I/O group.)
2. The detailed information about a single I/O group.

Syntax

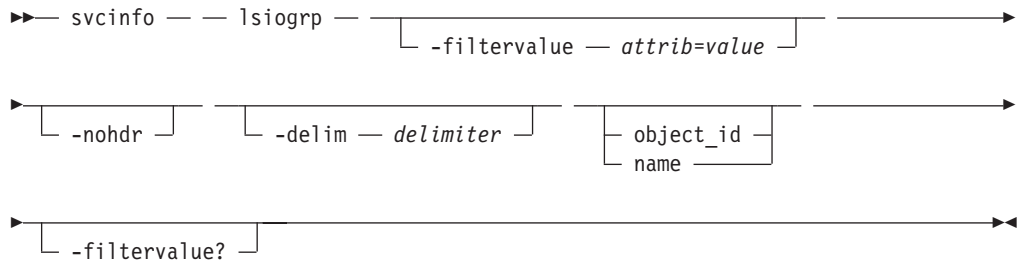

Parameters

-filtervalue *attribute=value*

(Optional) Specifies a list of one or more filters. Only objects with a value that matches the filter attribute value are returned. If a capacity is specified, the units must also be included.

Note: Some filters allow the use of a wildcard when entering the command. The following rules apply to the use of wildcards with the SAN Volume Controller CLI:

- The wildcard character is an asterisk (*).
- The command can contain a maximum of one wildcard.
- When using a wildcard, it is important to surround that filter entry with double quotes like the following display:

```
>svcinfo lsiogrp -filtervalue "name=md*"
```

-nohdr

(Optional) By default, headings are displayed for each column of data (in a concise style view) and each item of data (in a detailed style view). The **-nohdr** parameter suppresses the display of these headings.

Note: If there is no data to be displayed (for example, an empty view has been returned), then headings are not displayed irrespective of whether the **-nohdr** option was used or not.

-delim *delimiter*

(Optional) By default in a concise view, all columns of data are space-separated. The width of each column is set to the maximum possible width of each item of data. In a detailed view, each item of data has its own row, and if the headers are displayed the data is separated from the header by a space. The **-delim** parameter overrides this behavior. Valid input for the **-delim** parameter is a one byte character. If you enter **-delim :** on the

command line, a colon is used to separate all items of data in a concise view; the spacing of columns does not occur. In a detailed view, the data is separated from its header by a colon.

object_id | name

(Optional) Specifies the name or ID of an object. When you use this parameter, the detailed view of the specific object is returned and any value specified by the **-filtervalue** parameter is ignored. If you do not specify the **-object_ID** or **-object_name** parameter, the concise view of all objects matching the filtering requirements specified by the **-filtervalue** parameter are displayed.

-filtervalue?

(Optional) Specifies that you want your report to display any or all of the list of valid filter attributes. The valid filter attributes for the **svcinfo lsiogrp** command are:

- HWS_name
- HWS_unique_id
- node_count
- vdisk_count
- name
- id
- host_count

Description

This command returns a concise list or a detailed view, of I/O groups visible to the cluster.

Possible failures

- CMMVC5786E The action failed because the cluster is not in a stable state.
- CMMVC5804E The action failed because an entity that was specified in the command does not exist.
- CMMVC6252E The command failed authorization because the session SSH key is wrong or was deleted.
- CMMVC6253E The command failed authorization because the session SSH key does not have the requisite role.

A concise and detailed invocation example

```
svcinfo lsiogrp -delim :
```

The concise and detailed resulting output

```
id:name:node_count:vdisk_count:host_count
0:io_grp0:1:0:0
1:io_grp1:0:0:0
2:io_grp2:0:0:0
3:io_grp3:0:0:0
4:recovery_io_grp:0:0:0
```

A detailed and detailed invocation example

```
svcinfo lsiogrp -delim : 2
```

The detailed and detailed resulting output

```
id:2
name:io_grp2
node_count:0
vdisk_count:0
host_count:0
```

Isiogrphost

The **Isiogrphost** displays a list of the hosts that are mapped to a specified I/O group.

Syntax

```
▶▶ svcinfo -- isiogrphost -- [-nohdr] [-delim delimiter]
▶ iogrp_id_or_name
```

Parameters

-nohdr

(Optional) Suppresses the display of these headings. By default, headings are displayed for each column of data (in a concise style view providing general information about objects of a particular type) and for each item of data (in a detailed style view providing much more information about a specific object of a particular type).

Note: If there is no data to be displayed (for example, an empty view), headings are not displayed even if the **-nohdr** option was used.

-delim *delimiter*

(Optional) By default in a concise view, all columns of data are space-separated. The width of each column is set to the maximum possible width of each item of data. In a detailed view, each item of data has its own row, and if the headers are displayed, the data is separated from the header by a space. The **-delim** parameter overrides this behavior. Valid input for the **-delim** parameter is a one-byte character. If, for example, you entered **-delim ;**, a colon separates all items of data in a concise view (for example, the spacing of columns does not occur) and in a detailed view the data is separated from its header by a colon.

iogrp_id_or_name

(Required) The ID or name of the I/O group for which a list of all mapped hosts is required.

Description

The **Isiogrphost** command displays a list of hosts that are mapped to a specified I/O group.

Possible failures

- CMMVC5786E The action failed because the cluster is not in a stable state.
- CMMVC5804E The action failed because an object that was specified in the command does not exist.
- CMMVC6252E The command failed authorization because the session SSH key is wrong or was deleted.

- CMMVC6253E The command failed authorization because the session SSH key does not have the requisite role.

An invocation example

```
svcinfo lsiogrphost -delim : 0
```

The resulting output

```
id:name
0:hostzero
1:hostone
```

lsigrpcandidate

Use the **lsigrpcandidate** command to list the I/O groups that can have nodes added to them.

Syntax

```

▶— svcinfo — — lsiogrpcandidate — —————▶
                                   └─nohdr┘
▶— —————▶
└─delim — delimiter┘

```

Parameters

-nohdr

(Optional) Suppresses the display of these headings. By default, headings are displayed for each column of data (in a concise style view providing general information about objects of a particular type) and for each item of data (in a detailed style view providing much more information about a specific object of a particular type).

Note: If there is no data to be displayed (for example, an empty view), headings are not displayed even if the **-nohdr** option was used.

-delim *delimiter*

(Optional) By default in a concise view, all columns of data are space-separated. The width of each column is set to the maximum possible width of each item of data. In a detailed view, each item of data has its own row, and if the headers are displayed, the data is separated from the header by a space. The **-delim** parameter overrides this behavior. Valid input for the **-delim** parameter is a one-byte character. If, for example, you entered **-delim :**, a colon separates all items of data in a concise view (for example, the spacing of columns does not occur) and in a detailed view the data is separated from its header by a colon.

Description

This command displays a list of I/O groups to which nodes can be added. Only the I/O group IDs are displayed.

Possible failures

- CMMVC5786E The action failed because the cluster is not in a stable state.
- CMMVC5804E The action failed because an entity that was specified in the command does not exist.

- CMMVC6252E The command failed authorization because the session SSH key is wrong or was deleted.
- CMMVC6253E The command failed authorization because the session SSH key does not have the requisite role.

An invocation example

```
svcinfo lsiogrpcandidate
```

The resulting output

```
id
0
1
2
3
4
```

lsiostatsdumps

The **lsiostatsdumps** command displays a list of dumps in the `/dumps/iostats` directory. Use the **svctask startstats** command to create these dumps.

Syntax

```

>>> svcinfo -- lsiostatsdumps -- [-nohdr]
<<<
[-delim delimiter] [node_id | node_name]

```

Parameters

-nohdr

(Optional) Suppresses the display of these headings. By default, headings are displayed for each column of data (in a concise style view providing general information about objects of a particular type) and for each item of data (in a detailed style view providing much more information about a specific object of a particular type).

Note: If there is no data to be displayed (for example, an empty view), headings are not displayed even if the **-nohdr** option was used.

-delim *delimiter*

(Optional) By default in a concise view, all columns of data are space-separated. The width of each column is set to the maximum possible width of each item of data. In a detailed view, each item of data has its own row, and if the headers are displayed, the data is separated from the header by a space. The **-delim** parameter overrides this behavior. Valid input for the **-delim** parameter is a one-byte character. If, for example, you entered **-delim ;**, a colon separates all items of data in a concise view (for example, the spacing of columns does not occur) and in a detailed view the data is separated from its header by a colon.

node_id | node_name

(Optional) Specifies the node ID or name to list the available dumps of the given type. If you do not specify a node, the dumps that are available on the configuration node are listed.

Description

This command displays a list of I/O statistics dumps. These dumps are created when you issue the **svctask startstats** command. If you do not specify a node, the dumps that are available on the configuration node are listed. The command displays files from the `/dumps/iostats` directory.

Possible failures

- CMMVC5786E The action failed because the cluster is not in a stable state.
- CMMVC6252E The command failed authorization because the session SSH key is wrong or was deleted.
- CMMVC6253E The command failed authorization because the session SSH key does not have the requisite role.

An invocation example

```
svcinfolsiostatsdumps
```

The resulting output

```
id          iostat_filename
0           v_stats_mala75_031123_072426
1           m_stats_mala75_031123_072425
```

Isiotracedumps

Use the **Isiotracedumps** command to display a list of files in the `/dumps/iotrace` directory.

Syntax

```
svcinfolsiotracedumps [-nohdr] [-delim delimiter] [node_id node_name]
```

Parameters

-nohdr

(Optional) Suppresses the display of these headings. By default, headings are displayed for each column of data (in a concise style view providing general information about objects of a particular type) and for each item of data (in a detailed style view providing much more information about a specific object of a particular type).

Note: If there is no data to be displayed (for example, an empty view), headings are not displayed even if the **-nohdr** option was used.

-delim delimiter

(Optional) By default in a concise view, all columns of data are space-separated. The width of each column is set to the maximum possible width of each item of data. In a detailed view, each item of data has its own row, and if the headers are displayed, the data is separated from the header by a space. The **-delim** parameter overrides this behavior. Valid input for the **-delim** parameter is a one-byte character. If, for example, you entered `-delim`

;, a colon separates all items of data in a concise view (for example, the spacing of columns does not occur) and in a detailed view the data is separated from its header by a colon.

node_id | node_name

(Optional) Specifies the node ID or name to list the available dumps of the given type. If you do not specify a node, the dumps that are available on the configuration node are listed.

Description

This command displays a list of I/O trace dumps. These dumps are created when you issue the **svctask settrace** command. If you do not specify a node, the dumps that are available on the configuration node are listed. The command displays files from the `/dumps/iotrace` directory.

Possible failures

- CMMVC5786E The action failed because the cluster is not in a stable state.
- CMMVC6252E The command failed authorization because the session SSH key is wrong or was deleted.
- CMMVC6253E The command failed authorization because the session SSH key does not have the requisite role.

An invocation example

```
svcinfolsiotracedumps
```

The resulting output

```
id          iotrace_filename
0           c1_mala75_030405_092155
1           c2_mala75_030405_092156
2           c3_mala75_030405_092158
3           c4_mala75_030405_092159
4           c5_mala75_030405_092201
```

lslicense

The **lslicense** command displays the current license (featurization) settings for the cluster. The settings are defined as having Copy Services status and the capacity of virtual storage that is licensed for use by this cluster.

Syntax

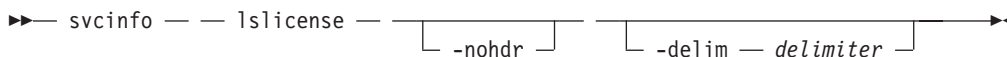

Parameters

-nohdr

(Optional) Suppresses the display of these headings. By default, headings are displayed for each column of data (in a concise style view providing general information about objects of a particular type) and for each item of data (in a detailed style view providing much more information about a specific object of a particular type).

Note: If there is no data to be displayed (for example, an empty view), headings are not displayed even if the **-nohdr** option was used.

-delim *delimiter*

(Optional) By default in a concise view, all columns of data are space-separated. The width of each column is set to the maximum possible width of each item of data. In a detailed view, each item of data has its own row, and if the headers are displayed, the data is separated from the header by a space. The **-delim** parameter overrides this behavior. Valid input for the **-delim** parameter is a one-byte character. If, for example, you entered **-delim ;**, a colon separates all items of data in a concise view (for example, the spacing of columns does not occur) and in a detailed view the data is separated from its header by a colon.

Description

This command displays the licensed features of the cluster. That is, the settings have Copy Services status and the capacity of virtual storage that is licensed for use by this cluster.

You can issue the **svcinfo lslicense** command to display the current license (featurization) settings for the cluster. You can issue the **svctask chlicense** command to change the licensed settings of the cluster. Because the feature settings are entered when the cluster is first created, you must update the settings only if you have changed your license. You can change the following values:

- FlashCopy: disabled or enabled
- Remote copy (Global or Metro Mirror): disabled or enabled
- Virtualization limit: number, in gigabytes (1073741824 bytes)

The displayed output lists the feature functions and displays whether they are enabled or disabled.

Possible failures

- CMMVC5786E The action failed because the cluster is not in a stable state.
- CMMVC6252E The command failed authorization because the session SSH key is wrong or was deleted.
- CMMVC6253E The command failed authorization because the session SSH key does not have the requisite role.

An invocation example

```
svcinfo lslicense
```

The resulting output

```
feature_flash on
feature_remote on
feature_num_gb 32
```

lsmdisk

The **lsmdisk** command returns a concise list or a detailed view of MDisks visible to the cluster. It can also list detailed information about a single managed disk.

Syntax

```
▶— svcinfo — — lsmdisk —————▶
```

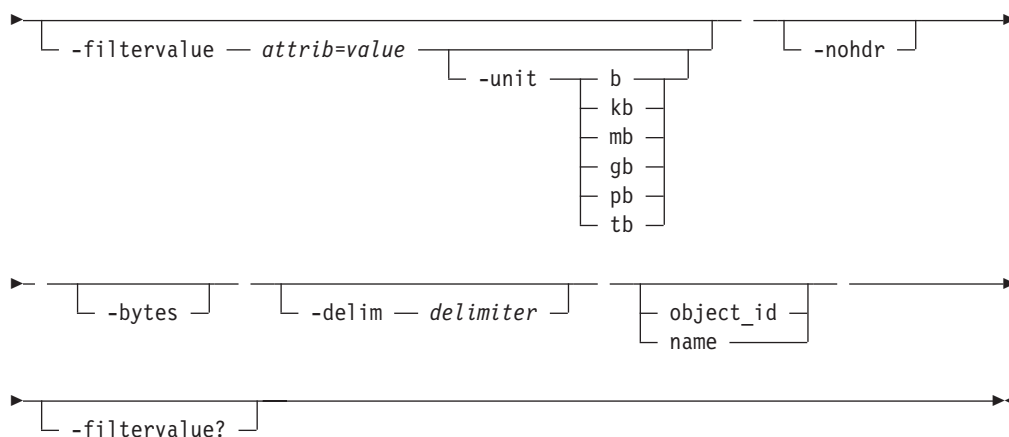

Parameters

-filtervalue *attribute=value*

(Optional) Specifies a list of one or more filters. Only objects with a value that matches the filter attribute value are returned. If a capacity is specified, the units must also be included.

Note: Some filters allow the use of a wildcard when entering the command. The following rules apply to the use of wildcards with the SAN Volume Controller CLI:

- The wildcard character is an asterisk (*).
- The command can contain a maximum of one wildcard.
- When using a wildcard, it is important to surround that filter entry with double quotes like the following display:

```
>svcinfolsmdisk -filtervalue "name=md*"
```

-nohdr

(Optional) By default, headings are displayed for each column of data (in a concise style view) and each item of data (in a detailed style view). The **-nohdr** parameter suppresses the display of these headings.

Note: If there is no data to be displayed (an empty view), headings are not displayed even if the **-nohdr** parameter is used.

-bytes

(Optional) Specifies that you want the report to display all capacities as bytes.

-delim *delimiter*

(Optional) By default in a concise view, all columns of data are space separated. The width of each column is set to the maximum possible width of each item of data. In a detailed view, each item of data has its own row, and if the headers are displayed the data is separated from the header by a space. The **-delim** parameter overrides this behavior. Valid input for the **-delim** parameter is a one-byte character. If you enter `-delim :` on the command line, a colon separates all items of data in a concise view; the spacing of columns does not occur. In a detailed view, the data is separated from its header by a colon.

object_id | name

(Optional) Specifies the name or ID of an object. When you use this parameter, the detailed view of the specific object is returned and any value that is specified by the **-filtervalue** parameter is ignored. If you do not specify the

-object_ID or **-object_name** parameter, the concise view of all objects matching the filtering requirements that is specified by the **-filtervalue** parameter are displayed.

-filtervalue?

(Optional) Specifies that you want your report to display any or all of the valid filter attributes. The following filter attributes are valid for the **svcinfolsmkdisk** command:

- name
- id
- status
- mode
- mdisk_grp_id
- mdisk_grp_name
- capacity
- controller_name

Description

This command returns a concise list or a detailed view of MDisks visible to the cluster.

The following list provides possible values that are applicable to the attributes that are displayed as data in the output views:

status	offline, excluded, degraded, online
mode	unmanaged, managed, image
quorum index	0,1,2 valid Quorum index

When back-end controllers are added to the fibre-channel SAN and are included in the same switch zone as a cluster, the cluster automatically discovers the back-end controller. The cluster determines from the controller which type of storage that it is presenting to the node. The SCSI LUs presented by the back-end controller are displayed as unmanaged MDisks. If, however; the configuration of the back-end controller is modified after this has occurred, the cluster might be unaware of these configuration changes. This task allows a user to request the cluster to re-scan the fibre-channel SAN to update the list of unmanaged MDisks.

Note: The automatic discovery performed by the cluster does not write anything to an unmanaged MDisk. It is only when the user instructs the cluster to add an MDisk to a managed disk group or use an MDisk to create an image mode virtual disk, that the system uses the storage.

Discovering MDisks: Check to see which MDisks are available by issuing the **svctask detectmdisk** command to manually scan the fibre-channel network for any MDisks. Issue the **svcinfolsmdiskcandidate** command to show the unmanaged MDisks. These MDisks have not been assigned to an MDisk group. Alternatively, you can issue the **svcinfolsmdisk** command to view all of the MDisks.

Each MDisk corresponds with a single RAID array, or a single partition on a given RAID array. Each RAID controller defines a LUN number for this disk. The LUN number and controller name or ID are needed to determine the relationship between MDisks and RAID arrays or partitions.

Determining the relationship between MDisks and RAID arrays or LUNs: Show the detailed view of the given MDisk <mdiskname>, by issuing the following command:

```
svcinfo lsmdisk <mdiskname>
```

where <mdiskname> is the name of the MDisk.

Note: Record the controller name or controller ID and controller LUN number for later use.

Show the detailed view of the controller by issuing the following command:

```
svcinfo lscontroller <controllername>
```

where <controllername> is the name of the controller.

Note: Record the vendor ID, product ID, and worldwide node name. Use these to determine what is being presented to the MDisk.

From the native user interface for the given controller, list the LUNs that the controller is presenting and match the LUN number. This value shows you the exact RAID array or partition that corresponds with the MDisk.

Possible failures

- CMMVC5786E The action failed because the cluster is not in a stable state.
- CMMVC5804E The action failed because an entity that was specified in the command does not exist.
- CMMVC6252E The command failed authorization because the session SSH key is wrong or was deleted.
- CMMVC6253E The command failed authorization because the session SSH key does not have the requisite role.

A concise invocation example

```
svcinfo lsmdisk -delim :
```

The concise resulting output

```
id:name:status:mode:mdisk_grp_id:mdisk_grp_name:capacity:
ctrl_LUN#:controller_name:UID
0:mdisk0:online:managed:0:mdiskgrp0:68.4GB:0000000000000000:controller0:
20000004cf2422aa0000000000000000000000000000000000000000000000000000
1:mdisk1:online:managed:0:mdiskgrp0:68.4GB:0000000000000000:controller1:
20000004cf1fd19d0000000000000000000000000000000000000000000000000000
2:mdisk2:online:managed:0:mdiskgrp0:68.4GB:0000000000000000:controller2:
20000004cf242531000000000000000000000000000000000000000000000000000
3:mdisk3:online:managed:0:mdiskgrp0:68.4GB:0000000000000000:controller3:
20000004cf1fd7a00000000000000000000000000000000000000000000000000000
4:mdisk4:online:unmanaged:::68.4GB:0000000000000000:controller4:
20000004cf241308000000000000000000000000000000000000000000000000000
5:mdisk5:online:unmanaged:::68.4GB:0000000000000000:controller5:
20000004cf2412ca0000000000000000000000000000000000000000000000000000
6:mdisk6:online:unmanaged:::68.4GB:0000000000000000:controller6:
20000004cf242123000000000000000000000000000000000000000000000000000
7:mdisk7:online:unmanaged:::68.4GB:0000000000000000:controller7:
20000004cf2412ac0000000000000000000000000000000000000000000000000000
8:mdisk8:online:unmanaged:::68.4GB:0000000000000000:controller8:
20000004cf2412de0000000000000000000000000000000000000000000000000000
9:mdisk9:online:unmanaged:::68.4GB:0000000000000000:controller9:
20000004cf1fd7cc00000000000000000000000000000000000000000000000000000
10:mdisk10:online:unmanaged:::68.4GB:0000000000000000:controller10:
```



```

20000004cf1ffe88000000000000000000000000000000000000000000000000000000000000000000
11:mdisk11:online:unmanaged:::68.4GB:0000000000000000:controller11:
20000004cf2412aa000000000000000000000000000000000000000000000000000000000000000000
12:mdisk12:online:unmanaged:::68.4GB:0000000000000000:controller12:
20000004cf242374000000000000000000000000000000000000000000000000000000000000000000
13:mdisk13:online:unmanaged:::68.4GB:0000000000000000:controller13:
20000004cf2419fe000000000000000000000000000000000000000000000000000000000000000000
14:mdisk14:online:unmanaged:::68.4GB:0000000000000000:controller14:
20000004cf241932000000000000000000000000000000000000000000000000000000000000000000

```

A detailed invocation example

```
svcinfa lsmdisk -delim : 2
```

The detailed resulting output

```

id:2
name:mdisk2
status:online
mode:unmanaged
mdisk_grp_id:
mdisk_grp_name:
capacity:68.4GB
quorum_index:
block_size:512
controller_name:controller2
ctrl_type:4
ctrl_WWNN:20000004CF242531
controller_id:2
path_count:1
max_path_count:1
ctrl_LUN #:0000000000000000
UID:20000004cf24253100000000000000000000000000000000000000000000000000000000000000000
preferred_WWPN:22000004CF242531
active_WWPN:22000004CF242531

```

The following define the `ctrl_type` fields:

- 0 Device that has not yet been processed.
- 1 Device is a node in which that cluster has not yet been identified.
- 2 Device is a node within this cluster.
- 3 Device is a node within a remote cluster.
- 4 Device is a back-end storage controller.
- 5 Device is a storage or other fabric device that is incompatible with the cluster.

lsmdiskcandidate

The `lsmdiskcandidate` command lists all of the unmanaged MDisks by MDisk ID.

Syntax

```

▶▶▶ svcinfo — — lsmdiskcandidate — —————▶
                                     | -nohdr |
▶▶▶ —————▶▶▶
  | -delim — delimiter |

```

Parameters

-nohdr

(Optional) Suppresses the display of these headings. By default, headings are displayed for each column of data (in a concise style view providing general information about objects of a particular type) and for each item of data (in a detailed style view providing much more information about a specific object of a particular type).

Note: If there is no data to be displayed (for example, an empty view), headings are not displayed even if the **-nohdr** option was used.

-delim *delimiter*

(Optional) By default in a concise view, all columns of data are space-separated. The width of each column is set to the maximum possible width of each item of data. In a detailed view, each item of data has its own row, and if the headers are displayed, the data is separated from the header by a space. The **-delim** parameter overrides this behavior. Valid input for the **-delim** parameter is a one-byte character. If, for example, you entered **-delim ;**, a colon separates all items of data in a concise view (for example, the spacing of columns does not occur) and in a detailed view the data is separated from its header by a colon.

Description

This command displays a list of MDisks that are unmanaged. Only the MDisk IDs are displayed.

When back-end controllers are added to the fibre-channel SAN and are included in the same switch zone as a cluster, the cluster automatically detects the back-end controller to determine which storage is presented to the node. The SCSI logical units that are presented by the back-end controller are displayed as unmanaged MDisks. However, if the configuration of the back-end controller is modified after this has occurred, the cluster might be unaware of these configuration changes. You can then request that the cluster rescan the fibre-channel SAN to update the list of unmanaged MDisks.

Note: The automatic detection performed by the cluster does not write anything to a unmanaged MDisk. It is only when you instruct the cluster to add an MDisk to a managed disk group or use a MDisk to create an image mode virtual disk that the storage is actually used.

Detecting MDisks: Check to see which MDisks are available by issuing the **svctask detectmdisk** command to manually scan the fibre-channel network for any MDisks. Issue the **svcinfo lsmdiskcandidate** command to show the unmanaged MDisks. These MDisks have not been assigned to an MDisk group. Alternatively, you can issue the **svcinfo lsmdisk** command to view all of the MDisks.

Possible failures

- CMMVC5786E The action failed because the cluster is not in a stable state.
- CMMVC5804E The action failed because an entity that was specified in the command does not exist.
- CMMVC6252E The command failed authorization because the session SSH key is wrong or was deleted.
- CMMVC6253E The command failed authorization because the session SSH key does not have the requisite role.

An invocation example

```
svcinfo lsmdiskcandidate
```

The resulting output

```
id
5
6
7
8
9
10
11
12
13
14
```

lsmdiskextent

The **lsmdiskextent** command displays the extent allocation between managed disks and virtual disks. The command displays a list, in which each entry contains a VDisk ID and the number of extents.

Syntax

```
▶▶ svcinfo — — lsmdiskextent — [ -nohdr ] —————▶
▶ [ -delim — delimiter ] [ mdisk_name | mdisk_id ] —————▶▶
```

Parameters

-nohdr

(Optional) Suppresses the display of these headings. By default, headings are displayed for each column of data (in a concise style view providing general information about objects of a particular type) and for each item of data (in a detailed style view providing much more information about a specific object of a particular type).

Note: If there is no data to be displayed (for example, an empty view), headings are not displayed even if the **-nohdr** option was used.

-delim *delimiter*

(Optional) By default in a concise view, all columns of data are space-separated. The width of each column is set to the maximum possible width of each item of data. In a detailed view, each item of data has its own row, and if the headers are displayed, the data is separated from the header by a space. The **-delim** parameter overrides this behavior. Valid input for the **-delim** parameter is a one-byte character. If, for example, you entered **-delim ;**, a colon separates all items of data in a concise view (for example, the spacing of columns does not occur) and in a detailed view the data is separated from its header by a colon.

mdisk_name | *mdisk_id*

(Required) Specifies the specific object ID or name of the given type.

Description

The command displays a list, in which each entry contains a VDisk ID and the number of extents. These VDIsks are using extents on the specified MDisk. The number of extents being used on each MDisk is also shown.

Every VDisk is constructed from one or more MDisks. At times, you might have to determine the relationship between the two objects. The following procedure allows you to determine the relationships.

Determining the relationship between VDIsks and MDisks: For each VDisk <vdiskname/id>, issue the following command:

```
svcinfo lsvdiskmember <vdiskname/id>
```

where <vdiskname/id> is the name or ID of the VDisk. This displays a list of IDs that correspond to the MDisks that make up the VDisk.

Determining the relationship between VDIsks and MDisks and the number of extents that are provided by each MDisk: You can determine the number of extents that are being provided by each MDisk. This procedure can only be performed using the command-line interface. For each VDisk <vdiskname/id>, issue the following command:

```
svcinfo lsvdiskextent <vdiskname/id>
```

where <vdiskname/id> is the name or ID of the VDisk. This displays a table of MDisk IDs and the corresponding number of extents that each MDisk is providing as storage for the given VDisk.

Determining the relationship between MDisks and VDIsks: For each MDisk <mdiskname/id>, issue the following command:

```
svcinfo lsmdiskmember <mdiskname/id>
```

where <mdiskname/id> is the name or ID of the MDisk. This displays a list of IDs that correspond to the VDIsks that are using this MDisk.

Determining the relationship between MDisks and VDIsks and the number of extents that are used by each VDisk: You can determine the number of extents that this MDisk is providing for each VDisk. This procedure can only be performed using the command-line interface. For each MDisk <mdiskname/id>, issue the following command:

```
svcinfo lsmdiskextent <mdiskname/id>
```

where <mdiskname/id> is the name or ID of the MDisk. This command displays a table of VDisk IDs and the corresponding number of extents being used by each VDisk.

Possible failures

- CMMVC5786E The action failed because the cluster is not in a stable state.
- CMMVC5804E The action failed because an entity that was specified in the command does not exist.

- CMMVC5854E The extent information was not returned because the extent is not used or does not exist.
- CMMVC5855E The extent information was not returned because the managed disk (MDisk) is not used by any virtual disk (VDisk).
- CMMVC5864E The extent information was not returned because the source extent is not used.
- CMMVC5865E The extent information was not returned because the extent is out of range for the managed disk (MDisk) or virtual disk (VDisk).
- CMMVC6005E The view request failed as the specified object is not a member of an appropriate group.
- CMMVC6252E The command failed authorization because the session SSH key is wrong or was deleted.
- CMMVC6253E The command failed authorization because the session SSH key does not have the requisite role.

An invocation example

```
svcinfo lsmdiskextent 2
```

The resulting output

```
id          number_of_extents
1           1
2           1
```

lsmdiskgrp

The **lsmdiskgrp** command returns a concise list or a detailed view, of MDisk groups visible to the cluster.

The list report style can be used to obtain two styles of report.

1. A list containing concise information about all the managed disk groups in a cluster. (Each entry in the list corresponds to a single managed disk group.)
2. The detailed information about a single managed disk group.

Syntax

```

▶▶ svcinfo — — lsmdiskgrp — [ -filtervalue — attrib=value ] —————▶
[ -nohdr ] [ -bytes ] [ -delim — delimiter ] —————▶
[ object_id — name ] [ -filtervalue? ] —————▶

```

Parameters

-filtervalue *attribute=value*

(Optional) Specifies a list of one or more filters. Only objects with a value that matches the filter attribute value are returned. If a capacity is specified, the units must also be included.

Note: Some filters allow the use of a wildcard when entering the command. The following rules apply to the use of wildcards with the SAN Volume Controller CLI:

- The wildcard character is an asterisk (*).
- The command can contain a maximum of one wildcard.
- When using a wildcard, it is important to surround that filter entry with double quotes like the following display:

```
>svcinfolsmdiskgrp -filtervalue "name=md*"
```

-nohdr

(Optional) By default, headings are displayed for each column of data (in a concise style view) and each item of data (in a detailed style view). The **-nohdr** parameter suppresses the display of these headings.

Note: If there is no data to be displayed (for example, an empty view has been returned), then headings are not displayed irrespective of whether the **-nohdr** parameter was used or not.

-bytes

(Optional) Specifies that you want the report to display all capacities as bytes.

-delim *delimiter*

(Optional) By default in a concise view, all columns of data are space-separated. The width of each column is set to the maximum possible width of each item of data. In a detailed view, each item of data has its own row, and if the headers are displayed the data is separated from the header by a space. The **-delim** parameter overrides this behavior. Valid input for the **-delim** parameter is a one byte character. If you enter **-delim :** on the command line, a colon is used to separate all items of data in a concise view; the spacing of columns does not occur. In a detailed view, the data is separated from its header by a colon.

object_id | name

(Optional) Specifies the name or ID of an object. When you use this parameter, the detailed view of the specific object is returned and any value specified by the **-filtervalue** parameter is ignored. If you do not specify the **-object_ID** or **-object_name** parameter, the concise view of all objects matching the filtering requirements specified by the **-filtervalue** parameter are displayed.

-filtervalue?

Display a list of valid filter attributes. The valid filters for the **svcinfolsmdiskgrp** command are:

- name
- storage_pool_id
- mdisk_count
- vdisk_count
- extent_size
- status
- id

Description

This command will return a concise list or a detailed view, of MDisk groups visible to the cluster.

The following list provides possible values that are applicable to the attributes that are displayed as data in the output views:

status online, degraded, offline

Possible failures

- CMMVC5786E The action failed because the cluster is not in a stable state.
- CMMVC5804E The action failed because an entity that was specified in the command does not exist.
- CMMVC6252E The command failed authorization because the session SSH key is wrong or was deleted.
- CMMVC6253E The command failed authorization because the session SSH key does not have the requisite role.

A concise invocation example

```
svcinfo lsmdiskgrp -delim :
```

The concise resulting output

```
id:name:status:mdisk_count:vdisk_count:capacity:extent_size:free_capacity
0:mdiskgrp0:online:5:0:341.8GB:16:341.8GB
1:mdiskgrp1:online:0:0:0:16:0
```

A detailed invocation example

```
svcinfo lsmdiskgrp -delim : 0
```

The detailed resulting output

```
id:0
name:mdiskgrp0
status:online
mdisk_count:5
vdisk_count:0
capacity:341.8GB
extent_size:16
free_capacity:341.8GB
```

lsmdiskmember

The **lsmdiskmember** command displays a list of VDisks that are using extents on the specified MDisk. That is, the virtual disks are using extents on the managed disk that are specified by the MDisk ID.

Syntax

```
▶▶ svcinfo — — lsmdiskmember — [ -nohdr ] —————▶
▶ [ -delim — delimiter ] [ mdisk_id —————▶
  [ mdisk_name ] —————▶
```

Parameters

-nohdr

(Optional) Suppresses the display of these headings. By default, headings are displayed for each column of data (in a concise style view providing general

information about objects of a particular type) and for each item of data (in a detailed style view providing much more information about a specific object of a particular type).

Note: If there is no data to be displayed (for example, an empty view), headings are not displayed even if the **-nohdr** option was used.

-delim *delimiter*

(Optional) By default in a concise view, all columns of data are space-separated. The width of each column is set to the maximum possible width of each item of data. In a detailed view, each item of data has its own row, and if the headers are displayed, the data is separated from the header by a space. The **-delim** parameter overrides this behavior. Valid input for the **-delim** parameter is a one-byte character. If, for example, you entered **-delim ;**, a colon separates all items of data in a concise view (for example, the spacing of columns does not occur) and in a detailed view the data is separated from its header by a colon.

mdisk_id | mdisk_name

(Required) Specifies the ID or name of the MDisk for which you want a list of VDIs that use extents of that MDisk.

Description

This command displays a list of virtual disks that use extents on the managed disk that are specified by the ID. The list displays members of the respective object and is independent of the state of the individual members; that is, if they are in offline state, they are still displayed.

Every VDisk is constructed from one or more MDisks. At times you might have to determine the relationship between the VDisk and the MDisk. The following procedure allows you to determine the relationships.

Determining the relationship between VDIs and MDisks: For each VDisk `<vdiskname/id>`, issue the following command:

```
svcinfolsvdiskmember <vdiskname/id>
```

where `<vdiskname/id>` is the name or ID of the VDisk. This displays a list of IDs that correspond to the MDisks that make up the VDisk.

Determining the relationship between VDIs and MDisks and the number of extents that are provided by each MDisk: You can also determine the number of extents that are being provided by each MDisk. This procedure can only be performed using the command-line interface. For each VDisk `<vdiskname/id>`, issue the following command:

```
svcinfolsvdiskextent <vdiskname/id>
```

where `<vdiskname/id>` is the name or ID of the VDisk. This command displays a table of MDisk IDs and the corresponding number of extents that each MDisk provides as storage for the VDisk.

Determining the relationship between MDisks and VDIs: For each MDisk `<mdiskname/id>`, issue the following command:

```
svcinfolsmdiskmember <mdiskname/id>
```

where *<mdiskname/id>* is the name or ID of the MDisk. This command displays a list of IDs that correspond to the VDisks that are using this MDisk.

Determining the relationship between MDisks and VDisks and the number of extents that are used by each VDisk: You can also determine the number of extents that this MDisk provides for each VDisk. This procedure can only be performed using the command-line interface. For each MDisk *<mdiskname/id>*, issue the following command:

```
svcinfo lsmdiskextent <mdiskname/id>
```

where *<mdiskname/id>* is the name or ID of the MDisk. This command displays a table of VDisk IDs and the corresponding number of extents being used by each VDisk.

Possible failures

- CMMVC5786E The action failed because the cluster is not in a stable state.
- CMMVC5804E The action failed because an entity that was specified in the command does not exist.
- CMMVC6252E The command failed authorization because the session SSH key is wrong or was deleted.
- CMMVC6253E The command failed authorization because the session SSH key does not have the requisite role.

An invocation example

```
svcinfo lsmdiskmember 1
```

The resulting output

```
id  
0
```

lsmigrate

The **lsmigrate** command displays the progress of all current data migration operations.

Syntax

```
▶▶ svcinfo -- lsmigrate -- [-nohdr] [-delim delimiter] ▶▶
```

Parameters

-nohdr

(Optional) Suppresses the display of these headings. By default, headings are displayed for each column of data (in a concise style view providing general information about objects of a particular type) and for each item of data (in a detailed style view providing much more information about a specific object of a particular type).

Note: If there is no data to be displayed (for example, an empty view), headings are not displayed even if the **-nohdr** option was used.

-delim *delimiter*

(Optional) By default in a concise view, all columns of data are

space-separated. The width of each column is set to the maximum possible width of each item of data. In a detailed view, each item of data has its own row, and if the headers are displayed, the data is separated from the header by a space. The **-delim** parameter overrides this behavior. Valid input for the **-delim** parameter is a one-byte character. If, for example, you entered **-delim ;**, a colon separates all items of data in a concise view (for example, the spacing of columns does not occur) and in a detailed view the data is separated from its header by a colon.

If you use multiple threads to migrate data, the progress will increment when all threads have completed the migration of an extent. For large extent sizes with many threads, this can result in quite large increments in the percentage progress.

Description

This command displays information of all the migrations that are currently in progress.

Possible failures

- CMMVC5786E The action failed because the cluster is not in a stable state.
- CMMVC5804E The action failed because an entity that was specified in the command does not exist.
- CMMVC6252E The command failed authorization because the session SSH key is wrong or was deleted.
- CMMVC6253E The command failed authorization because the session SSH key does not have the requisite role.

An invocation example

```
svcinfo lsmigrate -delim :
```

The resulting output

```
migrate_type:MDisk_Group_Migration
progress:96
migrate_source_vdisk_index:33
migrate_target_mdisk_grp:4
max_thread_count:4
```

lsnode

The **lsnode** command returns a concise list or a detailed view of nodes visible to the cluster.

The list report style can be used to obtain two styles of report.

1. A list containing concise information about all the nodes on a cluster. (Each entry in the list corresponds to a single node.)
2. The detailed information about a single node.

Syntax

```
➔➔➔ svcinfo — — lsnode — — [ -filtervalue — attrib=value ] ➔➔➔
```

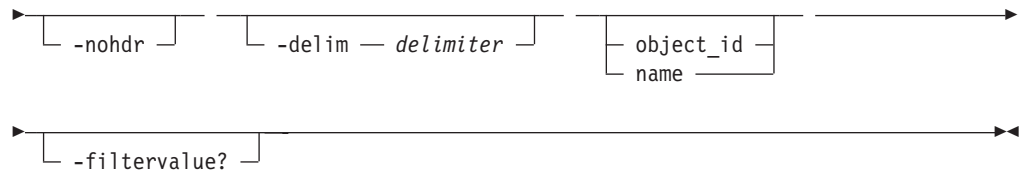

Parameters

-filtervalue *attribute=value*

(Optional) Specifies a list of one or more filters. Only objects with a value that matches the filter attribute value are returned. If a capacity is specified, the units must also be included.

Note: Some filters allow the use of a wildcard when entering the command. The following rules apply to the use of wildcards with the SAN Volume Controller CLI:

- The wildcard character is an asterisk (*).
- The command can contain a maximum of one wildcard.
- When using a wildcard, it is important to surround that filter entry with double quotes like the following display:

```
>svcinfolsnode -filtervalue "name=md*"
```

-nohdr

(Optional) By default, headings are displayed for each column of data (in a concise style view) and each item of data (in a detailed style view). The **-nohdr** parameter suppresses the display of these headings.

Note: If there is no data to be displayed (for example, an empty view has been returned), then headings are not displayed irrespective of whether the **-nohdr** parameter was used or not.

-delim *delimiter*

(Optional) By default in a concise view, all columns of data are space-separated. The width of each column is set to the maximum possible width of each item of data. In a detailed view, each item of data has its own row, and if the headers are displayed the data is separated from the header by a space. The **-delim** parameter overrides this behavior. Valid input for the **-delim** parameter is a one byte character. If you enter **-delim :** on the command line, a colon is used to separate all items of data in a concise view; the spacing of columns does not occur. In a detailed view, the data is separated from its header by a colon.

object_id | name

(Optional) Specifies the name or ID of an object. When you use this parameter, the detailed view of the specific object is returned and any value that is specified by the **-filtervalue** parameter is ignored. If you do not specify the **-object_ID** or **-object_name** parameter, the concise view of all objects matching the filtering requirements that is specified by the **-filtervalue** parameter are displayed.

-filtervalue?

Display a list of valid filter attributes. The valid filters for the **svcinfolsnode** command are:

- node_name
- id

- status
- IO_group_name
- IO_group_id
- name
- hardware

Description

This command returns a concise list or a detailed view of nodes visible to the cluster.

The following list provides the possible values that are applicable to the attributes that are displayed as data in the output views:

status	offline, flushing, pending, online, adding, deleting
config_node	no, yes
port_status	active, inactive, not installed
hardware	4F2, 8F2, 8F4, 8G4, other

Determining a node's WWPNs: List the nodes in the cluster by issuing the following command:

```
svcinfo lsnode
```

Note: Remember the node name or ID because you use this value in the next step. For the node or nodes in question, issue the following command:

```
svcinfo lsnode <nodename/id>
```

where <nodename/id> is the node name or ID.

Note: Remember the four port ID's (WWPNs).

Attention: If the node is in the adding state, the WWPN is displayed as 0000000000000000. Once the node has successfully become a member of the cluster, the state changes to online and the WWPN is displayed correctly.

Possible failures

- CMMVC5786E The action failed because the cluster is not in a stable state.
- CMMVC5804E The action failed because an entity that was specified in the command does not exist.
- CMMVC6252E The command failed authorization because the session SSH key is wrong or was deleted.
- CMMVC6253E The command failed authorization because the session SSH key does not have the requisite role.

A concise invocation example

```
svcinfo lsnode -delim :
```

The concise resulting output

```
id:name: UPS_serial_number: WWNN:
  status: IO_group_id: IO_group_name:
  config_node: UPS_unique_id: hardware
1:node1: UPS_SN: 5005076801000024:
  online: 0: io_grp0: yes:
  1000000000000024: other
```

A detailed invocation example

```
svcinfolsnode -delim = 1
```

The detailed resulting output

```
id=1
name=node1
UPS_serial_number=UPS_Fake_SN
WWNN=50050768010007E5
status=online
IO_group_id=0
IO_group_name=io_grp0
partner_node_id=
partner_node_name=
config_node=yes
UPS_unique_id=10000000000007E5
port_id=50050768011007E5
port_status=active
port_speed=2
port_id=50050768012007E5
port_status=inactive
port_speed=2
port_id=50050768013007E5
port_status=not_installed
port_speed=2
port_id=50050768014007E5
port_status=not_installed
port_speed=2
hardware=8F2
```

lsnodecandidate

The **lsnodecandidate** command lists all of the nodes that are not assigned to a cluster.

Syntax

```
svcinfolsnodecandidate [-nohdr]
                        [-delim delimiter]
```

Parameters

-nohdr

(Optional) Suppresses the display of these headings. By default, headings are displayed for each column of data (in a concise style view providing general information about objects of a particular type) and for each item of data (in a detailed style view providing much more information about a specific object of a particular type).

Note: If there is no data to be displayed (for example, an empty view), headings are not displayed even if the **-nohdr** option was used.

-delim *delimiter*

(Optional) By default in a concise view, all columns of data are space-separated. The width of each column is set to the maximum possible width of each item of data. In a detailed view, each item of data has its own row, and if the headers are displayed, the data is separated from the header by a space. The **-delim** parameter overrides this behavior. Valid input for the **-delim** parameter is a one-byte character. If, for example, you entered **-delim ;**, a colon separates all items of data in a concise view (for example, the spacing of columns does not occur) and in a detailed view the data is separated from its header by a colon.

Description

This command displays a list of nodes that are not assigned to a cluster.

Possible failures

- CMMVC5786E The action failed because the cluster is not in a stable state.
- CMMVC5804E The action failed because an entity that was specified in the command does not exist.
- CMMVC6252E The command failed authorization because the session SSH key is wrong or was deleted.
- CMMVC6253E The command failed authorization because the session SSH key does not have the requisite role.

An invocation example

```
svcinfo lsnodecandidate -delim :
```

The resulting output

```
id: panel_name: UPS_serial_number:  
UPS_unique_id: hardware  
50050768010000EF: oneg55:  
UPS_Fake_SN:10000000000000EF: other
```

lsnodevpd

The **lsnodevpd** command displays the vital product data (VPD) for each node.

Syntax

```
➤➤➤ svcinfo — — lsnodevpd — — [ -nohdr ] [ -delim — delimiter ]  
➤➤➤ [ node_id ]  
➤➤➤ [ node_name ]
```

Parameters

-nohdr

(Optional) Suppresses the display of these headings. By default, headings are displayed for each column of data (in a concise style view providing general information about objects of a particular type) and for each item of data (in a detailed style view providing much more information about a specific object of a particular type).

Note: If there is no data to be displayed (for example, an empty view), headings are not displayed whether the **-nohdr** option was used or not.

-delim *delimiter*

(Optional) By default in a concise view, all columns of data are space-separated. The width of each column is set to the maximum possible width of each item of data. In a detailed view, each item of data has its own row, and if the headers are displayed, the data is separated from the header by a space. The **-delim** parameter overrides this behavior. Valid input for the **-delim** parameter is a one-byte character. If, for example, you entered **-delim ;**, a colon separates all items of data in a concise view (for example, the spacing of columns does not occur) and in a detailed view the data is separated from its header by a colon.

node_id | node_name

(Required) Specifies the node by its ID or name.

Description

This command displays the VPD for the specified node. Each field is reported on a new line. All fields are strings. The VPD is split into sections. Each section has a section heading. The number of fields in that section follows each heading. Each section is separated by an empty line.

For example:

```
section name:3 fields
field1:value
field2:value
field3:value
```

```
new section:x fields
...
```

Some sections contain information about multiple objects of that type. Each object within the section is separated by an empty line.

For example:

```
section name:4 fields
object1 field1:value
object1 field2:value

object2 field1:value
object2 field2:value
```

```
new section: x fields
...
```

Note: The VPD for an 8F4 node displays the device serial number of the fibre-channel card as N/A.

Possible failures

- CMMVC5786E The action failed because the cluster is not in a stable state.
- CMMVC5804E The action failed because an entity that was specified in the command does not exist.

- CMMVC6252E The command failed authorization because the session SSH key is wrong or was deleted.
- CMMVC6253E The command failed authorization because the session SSH key does not have the requisite role.

An invocation example

```
svcinfo lsnodevpd 1
```

The resulting output

```
id 1

system board: 17 fields

part_number Unknown
system_serial_number 550117N
number_of_processors 2
number_of_memory_slots 4
number_of_fans 0
number_of_FC_cards 1

number_of_scsi/ide_devices 2
BIOS_manufacturer IBM
BIOS_version -[QAE115AUS-1.01]-
BIOS_release_date 08/16/2001
system_manufacturer IBM
system_product eserver xSeries 342 -[86691RX]-
planar_manufacturer IBM
power_supply_part_number Unknown
CMOS_battery_part_number Unknown
power_cable_assembly_part_number Unknown
service_processor_firmware N/A

processor: 6 fields
processor_location Processor 1
number_of_caches 2

manufacturer GenuineIntel
version Pentium III
speed 1000
status Enabled
processor cache: 4 fields
type_of_cache Internal L1 Cache
size_of_cache (KB) 32

type_of_cache Internal L2 Cache
size_of_cache (KB) 256

processor: 6 fields
processor_location Processor 2
number_of_caches 2
manufacturer GenuineIntel
version Pentium III
speed 1000
status Enabled

processor cache: 4 fields
type_of_cache Internal L1 Cache
size_of_cache (KB) 32

type_of_cache Internal L2 Cache
size_of_cache (KB) 256
memory module: 16 fields
part_number 33L5039
device_location J1
bank_location Slot1 in bank 1
```



```

size (MB) 1024
part_number 33L5039
device_location J4
bank_location Slot2 in bank 1
size (MB) 1024

part_number N/A
device_location J2
bank_location Slot1 in bank 2
size (MB) 0

part_number N/A
device_location J3
bank_location Slot2 in bank 2
size (MB) 0

FC card: 5 fields
part_number 64P7783
port_numbers 1 2
device_serial_number VSI 0000AD3F4
manufacturer Agilent
device DX2
device: 15 fields
part_number Unknown
bus ide0
device 0
model LG CD-ROM CRN-8245B
revision 1.13
serial_number
approx_capacity 0
part_number Unknown
bus scsi
device 0
device_vendor IBM-ESXS
model ST318305LC !#
revision 6C48
serial_number 3JKQ93B903196C48
approx_capacity 8
software: 5 fields
code_level 00000000
node_name node1
ethernet_status 1
WWNN 0x50050768010007e5

id 1

front panel assembly: 3 fields
part_number Unknown
front_panel_id lynn02
front_panel_locale en_US

UPS: 10 fields
electronics_assembly_part_number FakElec
battery_part_number FakBatt
frame_assembly_part_number FakFram
input_power_cable_part_number FakCab1
UPS_serial_number UPS_Fake_SN
UPS_type Fake UPS
UPS_internal_part_number UPS_Fake_PN
UPS_unique_id 0x10000000000007e5
UPS_main_firmware 1.4
UPS_comms_firmware 0.0

```

lsrcconsistgrp

The **lsrcconsistgrp** command returns a concise list or a detailed view of Metro or Global Mirror consistency groups visible to the cluster.

The list report style can be used to obtain two styles of report.

1. A list containing concise information about all the Metro or Global Mirror consistency groups visible to the cluster. (Each entry in the list corresponds to a single Metro or Global Mirror consistency group.)
2. The detailed information about a single Metro or Global Mirror consistency group.

Syntax

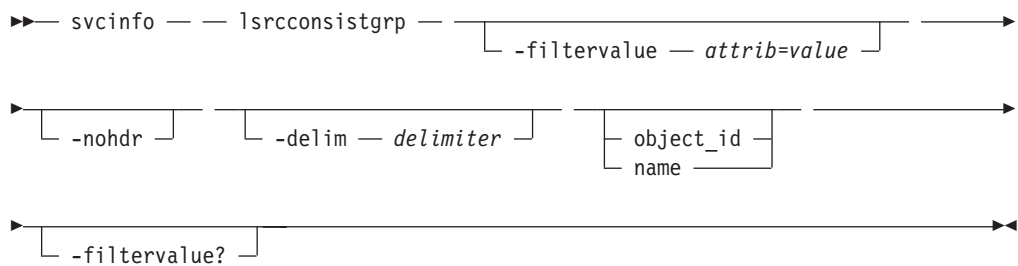

Parameters

-filtervalue *attribute=value*

(Optional) Specifies a list of one or more filters. Only objects with a value that matches the filter attribute value are displayed. If a capacity is specified, the units must also be included.

Note: Some filters allow the use of a wildcard when entering the command. The following rules apply to the use of wildcards with the SAN Volume Controller CLI:

- The wildcard character is an asterisk (*).
- The command can contain a maximum of one wildcard.
- When using a wildcard, it is important to surround that filter entry with double quotes like the following display:

```
>svcinfo lsrcconsistgrp -filtervalue "name=md*"
```

-nohdr

(Optional) By default, headings are displayed for each column of data (in a concise style view) and each item of data (in a detailed style view). The **-nohdr** parameter suppresses the display of these headings.

Note: If there is no data to be displayed (for example, an empty view has been returned), then headings are not displayed irrespective of whether the **-nohdr** parameter was used or not.

-delim *delimiter*

(Optional) By default in a concise view, all columns of data are space-separated. The width of each column is set to the maximum possible width of each item of data. In a detailed view, each item of data has its own row, and if the headers are displayed the data is separated from the header by a space. The **-delim** parameter overrides this behavior. Valid input for the **-delim** parameter is a one byte character. If you enter **-delim :** on the

command line, a colon is used to separate all items of data in a concise view; the spacing of columns does not occur. In a detailed view, the data is separated from its header by a colon.

object_id | name

(Optional) Specifies the name or ID of an object. When you use this parameter, the detailed view of the specific object is displayed and any value that is specified by the **-filtervalue** parameter is ignored. If you do not specify the **-object_ID** or **-object_name** parameter, the concise view of all objects matching the filtering requirements that is specified by the **-filtervalue** parameter are displayed.

-filtervalue?

(Optional) Specifies that you want your report to display any or all of the list of valid filter attributes. The following filter attributes for the **svcinfolsrcconsistgrp** command are valid:

- group_id
- name
- master_cluster_id
- master_cluster_name
- aux_cluster_id
- aux_cluster_name
- primary
- state
- relationship_count
- id
- copy_type

Description

This command returns a concise list or a detailed view of Metro or Global Mirror consistency groups that are visible to the cluster.

The following list provides possible values that are applicable to the attributes that are displayed as data in the output views:

primary	n/a, master, aux
state	inconsistent_stopped, inconsistent_copying, consistent_stopped, consistent_synchronized, idling, idling_disconnected, inconsistent_disconnected consistent_disconnected, empty
freeze_time	The time in YY/MM/DD/HH/MM format.
status	online, primary_offline, secondary_offline
sync	in_sync, out_of_sync
copy_type	metro, global, empty_group

Note: The names of the Metro or Global Mirror relationships and consistency groups might be blank if the relationship or consistency groups are intercluster and the cluster partnership is disconnected.

Possible failures

- CMMVC5786E The action failed because the cluster is not in a stable state.

- CMMVC5804E The action failed because an entity that was specified in the command does not exist.
- CMMVC6252E The command failed authorization because the session SSH key is wrong or was deleted.
- CMMVC6253E The command failed authorization because the session SSH key does not have the requisite role.

A concise invocation example

```
svcinfo lsrrconsistgrp -delim :
```

The concise resulting output

```
id:name:master_cluster_id:master_cluster_name:aux_cluster_id:aux_cluster_name:primary:state:relationship_count:copy_type

248:jdemo_BA_cons1:0000020060406746:clusterB:0000020061413ABA:clusterA:master:consistent_stopped:2:global
249:rccstgrp0:0000020061413ABA:clusterA:0000020061413ABA:clusterA::empty:0
:empty_group
250:jdemo_BA_cons2:0000020060406746:clusterB:0000020061413ABA:clusterA:master:inconsistent_stopped:1:metro
251:BA_cons1:0000020060406746:clusterB:0000020061413ABA:clusterA:master:consistent_stopped:4:metro
252:AB_cons2:0000020061413ABA:clusterA:0000020060406746:clusterB::empty:0
:empty_group
253:AB_cons1:0000020061413ABA:clusterA:0000020060406746:clusterB:aux:consistent_stopped:3:global
254:AA_cons2:0000020061413ABA:clusterA:0000020061413ABA:clusterA::empty:0
:empty_group
255:AA_cons1:0000020061413ABA:clusterA:0000020061413ABA:clusterA:master:consistent_synchronized:2:global
```

A detailed invocation example

```
svcinfo lsrrconsistgrp -delim : 254
```

The detailed resulting output

```
id:254
name:rccstgrp0
master_cluster_id:0000010030A007E5
master_cluster_name:kkk
aux_cluster_id:0000010030A007E5
aux_cluster_name:kkk
primary:master
state:inconsistent_stopped
relationship_count:1
freeze_time:
status:online
sync:
copy_type:metro
RC_rel_id:2
RC_rel_name:aaa
```

lsrrconsistgrp

The **lsrrconsistgrp** command returns a concise list or a detailed view of Metro or Global Mirror relationships visible to the cluster.

The list report style can be used to obtain two styles of report.

1. A list containing concise information about all the Metro or Global Mirror relationships visible to the cluster. (Each entry in the list corresponds to a single Metro or Global Mirror relationship.)

2. The detailed information about a single Metro or Global Mirror relationship.

Syntax

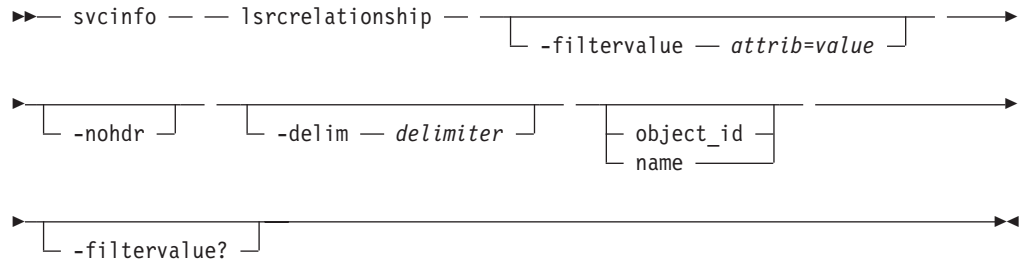

Parameters

-filtervalue *attribute=value*

(Optional) Specifies a list of one or more filters. Only objects with a value that matches the filter attribute value are returned. If a capacity is specified, the units must also be included.

Note: Some filters allow the use of a wildcard when entering the command. The following rules apply to the use of wildcards with the SAN Volume Controller CLI:

- The wildcard character is an asterisk (*).
- The command can contain a maximum of one wildcard.
- When using a wildcard, it is important to surround that filter entry with double quotes like the following display:

```
>svcinfo lsrelationship -filtervalue "name=md*"
```

-nohdr

(Optional) By default, headings are displayed for each column of data (in a concise style view) and each item of data (in a detailed style view). The **-nohdr** parameter suppresses the display of these headings.

Note: If there is no data to be displayed (for example, an empty view has been returned), then headings are not displayed irrespective of whether the **-nohdr** parameter was used or not.

-delim *delimiter*

(Optional) By default in a concise view, all columns of data are space-separated. The width of each column is set to the maximum possible width of each item of data. In a detailed view, each item of data has its own row, and if the headers are displayed the data is separated from the header by a space. The **-delim** parameter overrides this behavior. Valid input for the **-delim** parameter is a one byte character. If you enter **-delim :** on the command line, a colon is used to separate all items of data in a concise view; the spacing of columns does not occur. In a detailed view, the data is separated from its header by a colon.

object_id | **name**

(Optional) Specifies the name or ID of an object. When you use this parameter, the detailed view of the specific object is returned and any value that is specified by the **-filtervalue** parameter is ignored. If you do not specify the **-object_ID** or **-object_name** parameter, the concise view of all objects matching the filtering requirements that are specified by the **-filtervalue** parameter are displayed.

-filtervalue?

(Optional) Specifies that you want your report to display any or all of the list of valid filter attributes. The valid filter attributes for the **svcinfo lsrelationship** command are:

- RC_rel_id
- RC_rel_name
- master_cluster_id
- master_cluster_name
- master_vdisk_id
- master_vdisk_name
- aux_cluster_id
- aux_cluster_name
- aux_vdisk_id
- aux_vdisk_name
- primary
- consistency_group_id
- consistency_group_name
- state
- progress
- copy_type

Description

This command returns a concise list or a detailed view of Metro or Global Mirror relationships visible to the cluster.

The following list provides possible values that are applicable to the attributes that are displayed as data in the output views:

primary	n/a, master, aux
state	inconsistent_stopped, inconsistent_copying, consistent_stopped, consistent_synchronized, idling, idling_disconnected, inconsistent_disconnected, consistent_disconnected
progress	0-100, n/a
freeze time	The time in YY/MM/DD/HH/MM format.
status	online, primary_offline, secondary_offline
sync	n/a, in_sync, out_of_sync
copy_type	metro, global

Note: The names of the Metro or Global Mirror relationships and consistency groups can be blank if the relationship or consistency groups are inter-cluster and the cluster partnership is disconnected.

Possible failures

- CMMVC5786E The action failed because the cluster is not in a stable state.
- CMMVC5804E The action failed because an entity that was specified in the command does not exist.
- CMMVC6252E The command failed authorization because the session SSH key is wrong or was deleted.

- CMMVC6253E The command failed authorization because the session SSH key does not have the requisite role.

A concise and detailed invocation example

```
svcinfolsrrelationship -delim : -filtervalue name=j*
```

The concise and detailed resulting output

```
id:name:master_cluster_id:master_cluster_name:master_vdisk_id:master_vdisk_name:
aux_cluster_id:aux_cluster_name:aux_vdisk_id:
aux_vdisk_name:primary:consistency_group_id:consistency_group_name:state:bg_copy
_priority:progress: copy_type
45:jrel_AB1:0000020061413ABA:clusterA:45:jdisk_B8:0000020060406746:clusterB:38:j
disk_B1:master:::consistent_stopped:50:metro
48:jrel_AB2:0000020061413ABA:clusterA:48:jdisk_A4:0000020060406746:clusterB:41:j
disk_B4:master:::consistent_synchronised:50:metro
49:jrel_BA_1:0000020060406746:clusterB:42:jdisk_B5:0000020061413ABA:clusterA:49:j
disk_A5:master:248:jdemo_BA_cons1:consistent_stopped:50:metro
50:jrel_BA_2:0000020060406746:clusterB:43:jdisk_B6:0000020061413ABA:clusterA:
50:jdisk_A6:master:248:jdemo_BA_cons1:consistent_stopped:50:metro
```

A detailed invocation example

```
svcinfolsrrelationship -delim : AB_2
```

The detailed resulting output

```
id:9
name:AB_2
master_cluster_id:0000020061413ABA
master_cluster_name:clusterA
master_vdisk_id:9
master_vdisk_name:stripe9
aux_cluster_id:0000020060406746
aux_cluster_name:clusterB
aux_vdisk_id:9
aux_vdisk_name:stripe9_b
primary:master
consistency_group_id:
consistency_group_name:
state:consistent_stopped
bg_copy_priority:50
progress:
freeze_time:2006/05/05/08/26/46
status:secondary_offline
sync:in_sync
copy_type:metro
```

lsrrelationshipcandidate

The **lsrrelationshipcandidate** command lists VDisks that are eligible to form Metro or Global Mirror relationships. You can list eligible VDisks that are on the local or remote cluster.

Syntax

```

>>— svcinfo — — lsrrelationshipcandidate —————>
|
| ┌── -master ───┬── master_vdisk_id ───┬── -aux ───┬── aux_cluster_id ───┬──
| │              │ └── master_vdisk_name ───┘      │ │ └── aux_cluster_name ───┘

```



Parameters

-master *master_vdisk_id* | *master_vdisk_name*

(Required) Specifies a particular VDisk to use as the master VDisk. The command finds candidates that match the size of this VDisk. If you are requesting candidate VDIsks on the local cluster, this command also matches the `io_group`.

-aux *aux_cluster_id* | *aux_cluster_name*

(Required) Specifies a remote cluster with VDisk candidates for an intercluster relationship. If you do not specify this parameter, the candidates on the local cluster are displayed.

-nohdr

(Optional) Suppresses the display of these headings. By default, headings are displayed for each column of data (in a concise style view providing general information about objects of a particular type) and for each item of data (in a detailed style view providing much more information about a specific object of a particular type).

Note: If there is no data to be displayed (for example, an empty view), headings are not displayed even if the **-nohdr** option was used.

-delim *delimiter*

(Optional) By default in a concise view, all columns of data are space-separated. The width of each column is set to the maximum possible width of each item of data. In a detailed view, each item of data has its own row, and if the headers are displayed, the data is separated from the header by a space. The **-delim** parameter overrides this behavior. Valid input for the **-delim** parameter is a one-byte character. If, for example, you entered `-delim :`, a colon separates all items of data in a concise view (for example, the spacing of columns does not occur) and in a detailed view the data is separated from its header by a colon.

Description

This command displays a list of VDIsks that can be either the master or the auxiliary disk for a Metro or Global Mirror relationship. VDisk IDs and names are displayed.

Possible failures

- CMMVC5786E The action failed because the cluster is not in a stable state.
- CMMVC5804E The action failed because an entity that was specified in the command does not exist.
- CMMVC6252E The command failed authorization because the session SSH key is wrong or was deleted.
- CMMVC6253E The command failed authorization because the session SSH key does not have the requisite role.

An invocation example

```
svcinfo lsrelationshipcandidate -delim :
```

The resulting output

```
id:vdisk_name
0:vdisk0
4:vdisk4
```

lsrcrelationshipprogress

You can use the **lsrcrelationshipprogress** command to display the progress of the background copy of a Metro Mirror or Global Mirror relationship as a percentage. When the initial background copy process for a relationship has completed, null is displayed for the progress of that relationship.

Syntax

```
►►— svcinfo — — lsrcrelationshipprogress — —————►
                                     └─ -nohdr ─┘

└─ -delim — delimiter ─┘ └─ rcrelationship_id ─┘————►
                             └─ rcrelationship_name ─┘
```

Parameters

-nohdr

(Optional) Suppresses the display of these headings. By default, headings are displayed for each column of data (in a concise style view providing general information about objects of a particular type) and for each item of data (in a detailed style view providing much more information about a specific object of a particular type).

Note: If there is no data to be displayed (for example, an empty view), headings are not displayed whether the **-nohdr** option was used or not.

-delim *delimiter*

(Optional) By default in a concise view, all columns of data are space-separated. The width of each column is set to the maximum possible width of each item of data. In a detailed view, each item of data has its own row, and if the headers are displayed, the data is separated from the header by a space. The **-delim** parameter overrides this behavior. Valid input for the **-delim** parameter is a one-byte character. If, for example, you entered **-delim ;**, a colon separates all items of data in a concise view (for example, the spacing of columns does not occur) and in a detailed view the data is separated from its header by a colon.

rcrelationship_id | **rcrelationship_name**

Specifies the object ID or name of the specified type.

Description

This command displays the progress of the background copy of a Metro Mirror or Global Mirror relationship as a percentage.

Possible failures

- CMMVC5786E The action failed because the cluster is not in a stable state.
- CMMVC5804E The action failed because an entity that was specified in the command does not exist.
- CMMVC6252E The command failed authorization because the session SSH key is wrong or was deleted.

- CMMVC6253E The command failed authorization because the session SSH key does not have the requisite role.

An invocation example

```
svcinfo lsrelationshipprogress -delim : 0
```

The resulting output

```
id:progress
0:58
```

Issoftwaredumps

Use the **Issoftwaredumps** command to display a list of software packages from the /home/admin/upgrade directory.

Syntax

```

➔➔➔ svcinfo -- Issoftwaredumps -- [ -nohdr ] ----->
                                     |-----|
                                     | node_id |
                                     | node_name|
----->
|-----|
| -delim -- delimiter |

```

Parameters

-nohdr

(Optional) Suppresses the display of these headings. By default, headings are displayed for each column of data (in a concise style view providing general information about objects of a particular type) and for each item of data (in a detailed style view providing much more information about a specific object of a particular type).

Note: If there is no data to be displayed (for example, an empty view), headings are not displayed whether the **-nohdr** option was used or not.

-delim *delimiter*

(Optional) By default in a concise view, all columns of data are space-separated. The width of each column is set to the maximum possible width of each item of data. In a detailed view, each item of data has its own row, and if the headers are displayed, the data is separated from the header by a space. The **-delim** parameter overrides this behavior. Valid input for the **-delim** parameter is a one-byte character. If, for example, you entered **-delim :**, a colon separates all items of data in a concise view (for example, the spacing of columns does not occur) and in a detailed view the data is separated from its header by a colon.

node_id | **node_name**

(Optional) Specifies the node ID or name to list the available dumps of the specific type. If you do not specify a node, the dumps that are available on the configuration node are listed.

Description

This command displays a list of software upgrade packages. These packages are copied as a result of software upgrades. If you do not specify a node, the packages that are available on the configuration node are listed. The command displays files

from the /home/admin/upgrade directory.

Possible failures

- CMMVC5786E The action failed because the cluster is not in a stable state.
- CMMVC6252E The command failed authorization because the session SSH key is wrong or was deleted.
- CMMVC6253E The command failed authorization because the session SSH key does not have the requisite role.

An invocation example

```
svcinfolsoftwareinfo
```

The resulting output

```
id          software_filename
0           s1_mala75_030405_092143
1           s2_mala75_030405_092145
2           s3_mala75_030405_092146
```

lsshkeys

Use the **lsshkeys** command to display a list of SSH (secure shell) keys that are available on the cluster.

Syntax

```
svcinfolsshkeys -user admin | service | all -nohdr
```

-delim delimiter

Parameters

-user *admin | service | all*

(Required) Specifies whether you want to see a list of keys that can be used by only a service user or an admin user or the list for both user types.

-nohdr

(Optional) Suppresses the display of these headings. By default, headings are displayed for each column of data (in a concise style view providing general information about objects of a particular type) and for each item of data (in a detailed style view providing much more information about a specific object of a particular type).

Note: If there is no data to be displayed (for example, an empty view), headings are not displayed even if the **-nohdr** option was used.

-delim *delimiter*

(Optional) By default in a concise view, all columns of data are space-separated. The width of each column is set to the maximum possible width of each item of data. In a detailed view, each item of data has its own row, and if the headers are displayed, the data is separated from the header by a space. The **-delim** parameter overrides this behavior. Valid input for the **-delim** parameter is a one-byte character. If, for example, you entered **-delim**

, a colon separates all items of data in a concise view (for example, the spacing of columns does not occur) and in a detailed view the data is separated from its header by a colon.

Description

This command displays a list of all the keys that are available on the cluster for the specified user ID.

Possible failures

- CMMVC5786E The action failed because the cluster is not in a stable state.
- CMMVC6252E The command failed authorization because the session SSH key is wrong or was deleted.
- CMMVC6253E The command failed authorization because the session SSH key does not have the requisite role.

An invocation example

```
svcinflssshkeys -user all -delim :
```

The resulting output

```
id:userid_key:identifier  
1:admin:admin
```

lstimezones

The **lstimezones** command lists the time zones that are available on the cluster. Each timezone is assigned an ID that can be used in the **svctask settimezone** command to set the time zone.

Syntax

```
svcinflstimezones [-nohdr] [-delim delimiter]
```

Parameters

-nohdr

(Optional) Suppresses the display of these headings. By default, headings are displayed for each column of data (in a concise style view providing general information about objects of a particular type) and for each item of data (in a detailed style view providing much more information about a specific object of a particular type).

Note: If there is no data to be displayed (for example, an empty view), headings are not displayed whether the **-nohdr** option was used or not.

-delim *delimiter*

(Optional) By default in a concise view, all columns of data are space-separated. The width of each column is set to the maximum possible width of each item of data. In a detailed view, each item of data has its own row, and if the headers are displayed, the data is separated from the header by a space. The **-delim** parameter overrides this behavior. Valid input for the **-delim** parameter is a one-byte character. If, for example, you entered **-delim**

;, a colon separates all items of data in a concise view (for example, the spacing of columns does not occur) and in a detailed view the data is separated from its header by a colon.

Description

This command displays a list of all the time zones that are available on the cluster. Each time zone is assigned an ID. This ID can be used in the `svctask settimezone` command.

Possible failures

- CMMVC5786E The action failed because the cluster is not in a stable state.
- CMMVC6252E The command failed authorization because the session SSH key is wrong or was deleted.
- CMMVC6253E The command failed authorization because the session SSH key does not have the requisite role.

An invocation example

```
svcinfolsttimezones
```

The resulting output

```
id timezone
0 Africa/Abidjan
1 Africa/Accra
2 Africa/Addis_Ababa
3 Africa/Algiers
4 Africa/Asmera
5 Africa/Bamako
6 Africa/Bangui
```

lsvdisk

The `lsvdisk` command displays a concise list or a detailed view of VDisks that are recognized by the cluster.

The list report style can be used to obtain two different styles of report.

- A list containing concise information about all the virtual disks that are recognized by the cluster. (Each entry in the list corresponds to a single virtual disk.)
- The detailed information about a single virtual disk.

Syntax

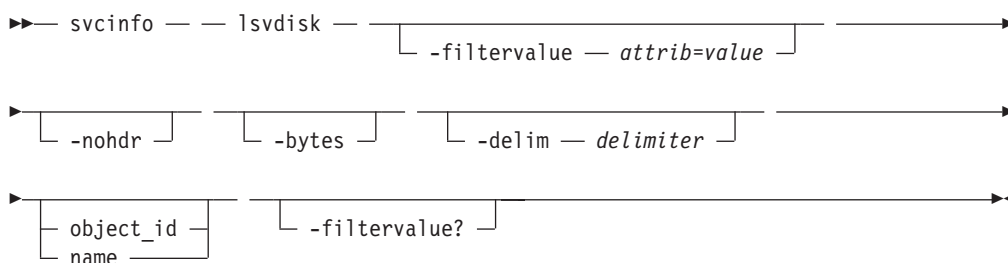

Parameters

-filtervalue *attribute=value*

(Optional) Specifies a list of one or more filters. Only objects with a value that matches the filter attribute value are displayed. If a capacity is specified, the units must also be included.

-nohdr

(Optional) The **-nohdr** parameter suppresses the display of these headings. By default, headings are displayed for each column of data (in a concise style view) and for each item of data (in a detailed style view).

Note: If there is no data to be displayed (for example, an empty view), then headings are not displayed whether the **-nohdr** option was used or not.

-bytes

(Optional) Displays all capacities as bytes.

-delim *delimiter*

(Optional) By default in a concise view, all columns of data are space-separated. The width of each column is set to the maximum possible width of each item of data. In a detailed view, each item of data has its own row, and if the headers are displayed, the data is separated from the header by a space. The **-delim** parameter overrides this behavior. Valid input for the **-delim** parameter is a one-byte character. If, for example, you entered **-delim ;**, a colon separates all items of data in a concise view (for example, the spacing of columns does not occur) and in a detailed view the data is separated from its header by a colon.

object_id | name

(Optional) Specifies the name or ID of an object. When you use this parameter, the detailed view of the specific object is returned and any value that is specified by the **-filtervalue** parameter is ignored. If you do not specify the **-object_ID** or **object_name** parameter, the concise view of all objects matching the filtering requirements that is specified by the **-filtervalue** parameter are displayed.

-filtervalue?

(Optional) Displays a list of valid filter attributes. The following filters for the **svcinfo lsvdisk** command are valid:

- vdisk_name
- vdisk_id
- vdisk_UID
- IO_group_id
- IO_group_name
- status
- mdisk_grp_name
- mdisk_grp_id
- capacity
- type
- FC_id
- FC_name
- RC_id
- RC_name
- name

- id
- fcmmap_count

Description

This command displays a concise list or a detailed view of VDisks that are recognized by the cluster.

The following list provides possible values that are applicable to the attributes that are displayed as data in the output views:

status	offline, online, degraded
capacity	Rounded to GB (2 decimal places) or MB if less than 1GB.
type	sequential, striped, image
formatted	no, yes
mdisk id	Not used for striped
mdisk name	Not used for striped
cache	read-write none

The VDisk is offline and unavailable if one of the following take place:

- If both nodes in the I/O group are missing
- None of the nodes in the I/O group that are present can access the VDisk.

A VDisk is reported as degraded if the following happened:

- One of the nodes in the I/O group is missing.
- One of the nodes in the I/O group cannot access all the MDisks in the MDisk group that the VDisk spans. In this case MDisks are shown as degraded and the DMPs for MDisks should be followed to resolve the problem.
- The fast write cache pins data for one or more VDisks in the I/O group and is unable to perform a failback until the situation is resolved. An error log indicating that the cache has pinned data is displayed. Follow the directed maintenance procedures for this error log to resolve the problem. The most common causes of pinned data are the following:
 - One or more VDisks in an I/O group is offline due to an asymmetric failure and has pinned data in the cache. Asymmetric failures can occur because of SAN fabric faults or misconfiguration, back-end controller faults or misconfiguration or because repeated errors has lead to the cluster excluding access to a MDisk through one or more nodes.
 - One or more VDisks in an I/O group is offline due to a problem with a FlashCopy mapping.

Possible failures

- CMMVC5786E The action failed because the cluster is not in a stable state.
- CMMVC5804E The action failed because an entity that was specified in the command does not exist.
- CMMVC6252E The command failed authorization because the session SSH key is wrong or was deleted.
- CMMVC6253E The command failed authorization because the session SSH key does not have the requisite role.

A concise invocation example

```
svcinfo lsvdisk -delim :
```

The concise resulting output

```
id:name:IO_group_id:IO_group_name:status:mdisk_grp_id:mdisk_grp_name:capacity:type:FC_id:
FC_name:RC_id:RC_name:vdisk_UID:fcmap_count
0:vdisk0:0:io_grp0:degraded:0:mdiskgrp0:16.0MB:striped:::::60050768017F06BF7800000000000000
1:vdisk1:0:io_grp0:degraded:0:mdiskgrp0:16.0MB:striped:::::60050768017F06BF7800000000000001
2:vdisk2:0:io_grp0:degraded:0:mdiskgrp0:16.0MB:striped:::::60050768017F06BF7800000000000002
3:vdisk3:0:io_grp0:degraded:0:mdiskgrp0:16.0MB:striped:::::60050768017F06BF7800000000000003
```

A detailed invocation example

```
svcinfo lsvdisk -delim : 1
```

The detailed resulting output

```
svcinfo lsvdisk -delim : 1
id:1
name:vdisk1
IO_group_id:0
IO_group_name:io_grp0
status:degraded
mdisk_grp_id:0
mdisk_grp_name:mdiskgrp0
capacity:16.0MB
type:striped
formatted:no
mdisk_id:
mdisk_name:
FC_id:
FC_name:
RC_id:
RC_name:
vdisk_UID:60050768017F06BF7800000000000001
throttling:0
preferred_node_id:1
fast_write_state:empty
cache:readwrite
udid:4326
fcmap_count:0
```

lsvdiskextent

Use the **lsvdiskextent** command to list the number of extents per MDisk that make up the VDisk and to determine the number of extents that are used by each VDisk. The number of extents that are provided by each MDisk is displayed.

Syntax

```
▶▶ svcinfo — — lsvdiskextent — — [ -nohdr ] —————▶
▶ [ -delim — delimiter ] [ vdisk_name vdisk_id ] —————▶
```

Parameters

-nohdr

(Optional) Suppresses the display of these headings. By default, headings are displayed for each column of data (in a concise style view providing general

information about objects of a particular type) and for each item of data (in a detailed style view providing much more information about a specific object of a particular type).

Note: If there is no data to be displayed (for example, an empty view), headings are not displayed whether the **-nohdr** option was used or not.

-delim *delimiter*

(Optional) By default in a concise view, all columns of data are space-separated. The width of each column is set to the maximum possible width of each item of data. In a detailed view, each item of data has its own row, and if the headers are displayed, the data is separated from the header by a space. The **-delim** parameter overrides this behavior. Valid input for the **-delim** parameter is a one-byte character. If, for example, you entered **-delim ;**, a colon separates all items of data in a concise view (for example, the spacing of columns does not occur) and in a detailed view the data is separated from its header by a colon.

vdisk_name | vdisk_id

(Required) Specifies one or more virtual disk IDs or names.

Description

The command displays a list in which each entry contains a MDisk ID and the number of extents. These MDisks are using extents on the specified VDisk. The number of extents on each VDisk is also shown.

Every VDisk is constructed from one or more MDisks. At times, you might have to determine the relationship between the two objects. The following procedure allows you to determine the relationships.

Determining the relationship between VDIsks and MDisks: For each VDisk `<vdiskname/id>`, issue the following command:

```
svcinfolsvdiskmember <vdiskname/id>
```

where `<vdiskname/id>` is the name or ID of the VDisk. This command displays a list of IDs that correspond to the MDisks that make up the VDisk.

Determining the relationship between VDIsks and MDisks and the number of extents that are provided by each MDisk: You can determine the number of extents that are provided by each MDisk. This procedure can only be performed using the command-line interface. For each VDisk `<vdiskname/id>`, issue the following command:

```
svcinfolsvdiskextent <vdiskname/id>
```

where `<vdiskname/id>` is the name or ID of the VDisk. This command displays a table of MDisk IDs and the corresponding number of extents that each MDisk provides as storage for the given VDisk.

Determining the relationship between MDisks and VDIsks: For each MDisk `<mdiskname/id>`, issue the following command:

```
svcinfolsmdiskmember <mdiskname/id>
```

where *<mdiskname/id>* is the name or ID of the MDisk. This command displays a list of IDs that corresponds to the VDisks that are using this MDisk.

Determining the relationship between MDisks and VDisks and the number of extents that are used by each VDisk: You can determine the number of extents that this MDisk provides for each VDisk. This procedure can only be performed using the command-line interface. For each MDisk *<mdiskname/id>*, issue the following command:

```
svcinfo lsmdiskextent <mdiskname/id>
```

where *<mdiskname/id>* is the name or ID of the MDisk. This command displays a table of VDisk IDs and the corresponding number of extents that are used by each VDisk.

Possible failures

- CMMVC5786E The action failed because the cluster is not in a stable state.
- CMMVC5804E The action failed because an entity that was specified in the command does not exist.
- CMMVC5854E The extent information was not returned because the extent is not used or does not exist.
- CMMVC5855E The extent information was not returned because the managed disk (MDisk) is not used by any virtual disk (VDisk).
- CMMVC5864E The extent information was not returned because the source extent is not used.
- CMMVC5865E The extent information was not returned because the extent is out of range for the managed disk (MDisk) or virtual disk (VDisk).
- CMMVC6252E The command failed authorization because the session SSH key is wrong or was deleted.
- CMMVC6253E The command failed authorization because the session SSH key does not have the requisite role.

An invocation example

```
svcinfo lsvdiskextent -delim : vdisk0
```

The resulting output

```
id:extent offset  
0:0
```

lsvdiskfcmappings

The **lsvdiskfcmappings** command displays a list of flash copy mappings to which the VDisk belongs. A VDisk can be part of up to 16 flash copy mappings.

Syntax

```
▶▶ svcinfo — — lsvdiskfcmappings — — -vdisk_name_or_ID —————▶▶
```

Parameters

-vdisk_name_or_ID

(Required) Specifies the name or id of the VDisk for which a list of all fc mappings is required.

Description

The **lsvdiskfcmappings** command returns a list of all flash copy mappings to which the VDisk is a member. The list is returned in no particular order.

An invocation example

```
svcinfolsvdiskfcmappings -delim : vdisk2
```

The resulting output

```
fc_id:fc_name  
1:fcmap1  
3:fcmap3
```

lsvdiskhostmap

Use the **lsvdiskhostmap** command to list the VDisk to the host mapping. These hosts have the specified virtual disk mapped to them, that is, the virtual disk is visible to these hosts.

Syntax

```
svcinfolsvdiskhostmap [-nohdr] [-delim delimiter] vdisk_id vdisk_name
```

Parameters

-nohdr

(Optional) Suppresses the display of these headings. By default, headings are displayed for each column of data (in a concise style view providing general information about objects of a particular type) and for each item of data (in a detailed style view providing much more information about a specific object of a particular type).

Note: If there is no data to be displayed (for example, an empty view), headings are not displayed even if the **-nohdr** option was used.

-delim *delimiter*

(Optional) By default in a concise view, all columns of data are space-separated. The width of each column is set to the maximum possible width of each item of data. In a detailed view, each item of data has its own row, and if the headers are displayed, the data is separated from the header by a space. The **-delim** parameter overrides this behavior. Valid input for the **-delim** parameter is a one-byte character. If, for example, you entered **-delim :**, a colon separates all items of data in a concise view (for example, the spacing of columns does not occur) and in a detailed view the data is separated from its header by a colon.

vdisk_id | **vdisk_name**

(Required) Specifies the ID or name of the virtual disk. The cluster displays a list of all the hosts to which this virtual disk is mapped and the SCSI ID by which the virtual disk is mapped.

Description

This command displays a list of host IDs and names. These hosts have the specified virtual disk mapped to them; that is, the virtual disk is visible to these hosts. The SCSI LUN ID is also displayed. The SCSI LUN ID is the ID by which the virtual disk is recognized by the host.

Determining the host that a VDisk is mapped to: List the hosts that this VDisk is mapped to, by issuing the following command:

```
svcinfo lsvdiskhostmap <vdiskname/id>
```

where *<vdiskname/id>* is the name or ID of the VDisk. A list is displayed. Look for the host name or ID to determine which host this VDisk is mapped to. If no data is displayed, the VDisk is not mapped to any hosts.

Possible failures

- CMMVC5786E The action failed because the cluster is not in a stable state.
- CMMVC5804E The action failed because an entity that was specified in the command does not exist.
- CMMVC6252E The command failed authorization because the session SSH key is wrong or was deleted.
- CMMVC6253E The command failed authorization because the session SSH key does not have the requisite role.

The concise invocation example

```
svcinfo lsvdiskhostmap -delim : 3
```

The concise resulting output

```
id:name:SCSI_id:host_id:host_name:wwpn:vdisk_UID  
3:vdisk3:0:2:host2:0000000000100ABC:60050768018A00015000000000000003
```

lsvdiskmember

The **lsvdiskmember** command displays a list of MDisks that are members of the specified VDisk.

Syntax

```
▶▶▶ svcinfo — — lsvdiskmember — [ -nohdr ] —————▶▶▶  
  
▶ [ -delim — delimiter ] [ vdisk_id — vdisk_name ] —————▶▶▶
```

Parameters

-nohdr

(Optional) Suppresses the display of these headings. By default, headings are displayed for each column of data (in a concise style view providing general information about objects of a particular type) and for each item of data (in a detailed style view providing much more information about a specific object of a particular type).

Note: If there is no data to be displayed (for example, an empty view), headings are not displayed whether the **-nohdr** option was used or not.

-delim *delimiter*

(Optional) By default in a concise view, all columns of data are space-separated. The width of each column is set to the maximum possible width of each item of data. In a detailed view, each item of data has its own row, and if the headers are displayed, the data is separated from the header by a space. The **-delim** parameter overrides this behavior. Valid input for the **-delim** parameter is a one-byte character. If, for example, you entered **-delim ;**, a colon separates all items of data in a concise view (for example, the spacing of columns does not occur) and in a detailed view the data is separated from its header by a colon.

vdisk_id | vdisk_name

(Required) Specifies the name or ID of the VDisk for the list of member MDisks.

Description

This command displays a list of managed disks, which provide extents that make up the virtual disk that is specified by the ID.

Every VDisk is constructed from one or more MDisks. At times, you might have to determine the relationship between the two objects. The following procedure allows you to determine the relationships.

If you use the **svcinfo lsmdiskmember** command, the concise view displays a list of virtual disks. These are the virtual disks that are using extents on the managed disk that is specified by the ID. The list displays the members of the respective object and is independent of the state of the individual members; that is, if they are in offline state, they are still displayed.

Determining the relationship between VDisks and MDisks: For a given VDisk `<vdiskname/id>`, issue the following command:

```
svcinfo lsvdiskmember <vdiskname/id>
```

where `<vdiskname/id>` is the name or ID of the VDisk. This displays a list of IDs that correspond to the MDisks that make up the VDisk.

Determining the relationship between VDisks and MDisks and the number of extents that are provided by each MDisk: You can also determine the number of extents that each MDisk provides. This procedure can only be performed using the command-line interface. For a given VDisk `<vdiskname/id>`, issue the following command:

```
svcinfo lsvdiskextent <vdiskname/id>
```

where `<vdiskname/id>` is the name or ID of the VDisk. This displays a table of MDisk IDs and the corresponding number of extents that each MDisk provides as storage for the specified VDisk.

Determining the relationship between MDisks and VDisks: For a given MDisk `<mdiskname/id>`, issue the following command:

```
svcinfo lsmdiskmember <mdiskname/id>
```

where *<mdiskname/id>* is the name or ID of the MDisk. This displays a list of IDs that correspond to the VDisks that are using this MDisk.

Determining the relationship between MDisks and VDisks and the number of extents that are used by each VDisk: You can also determine the number of extents that this MDisk provides for each VDisk. This procedure can only be performed using the command-line interface. For a specified MDisk *<mdiskname/id>*, issue the following command:

```
svcinfo lsmdiskextent <mdiskname/id>
```

where *<mdiskname/id>* is the name or ID of the MDisk. This displays a table of VDisk IDs and the corresponding number of extents that are used by each VDisk.

Possible failures

- CMMVC5786E The action failed because the cluster is not in a stable state.
- CMMVC5804E The action failed because an entity that was specified in the command does not exist.
- CMMVC6252E The command failed authorization because the session SSH key is wrong or was deleted.
- CMMVC6253E The command failed authorization because the session SSH key does not have the requisite role.

An invocation example

```
svcinfo lsvdiskmember 1
```

The resulting output

```
id  
2
```

lsvdiskprogress

The **lsvdiskprogress** command tracks the progress during new virtual disk formatting.

Syntax

```
svcinfo -- lsvdiskprogress -- [-nohdr] --  
[-delim delimiter] vdisk_id vdisk_name
```

Parameters

-nohdr

(Optional) Suppresses the display of these headings. By default, headings are displayed for each column of data (in a concise style view providing general information about objects of a particular type) and for each item of data (in a detailed style view providing much more information about a specific object of a particular type).

Note: If there is no data to be displayed (for example, an empty view), headings are not displayed whether the **-nohdr** option was used or not.

-delim *delimiter*

(Optional) By default in a concise view, all columns of data are space-separated. The width of each column is set to the maximum possible width of each item of data. In a detailed view, each item of data has its own row, and if the headers are displayed, the data is separated from the header by a space. The **-delim** parameter overrides this behavior. Valid input for the **-delim** parameter is a one-byte character. If, for example, you entered **-delim :**, a colon separates all items of data in a concise view (for example, the spacing of columns does not occur) and in a detailed view the data is separated from its header by a colon.

vdisk_id | **vdisk_name**

(Required) Specifies the specific object ID or name of the specified type.

Description

This command displays the progress of the format of a new virtual disk as a completed percentage.

Possible failures

- CMMVC5786E The action failed because the cluster is not in a stable state.
- CMMVC5804E The action failed because an entity that was specified in the command does not exist.
- CMMVC5805E The progress information was not returned because the FlashCopy statistics are not ready yet.
- CMMVC6252E The command failed authorization because the session SSH key is wrong or was deleted.
- CMMVC6253E The command failed authorization because the session SSH key does not have the requisite role.

An invocation example

```
svcinflsvdiskprogress -delim : 0
```

The resulting output

```
id:progress  
0:58
```

showtimezone

Use the **showtimezone** command to display the current time zone settings for the cluster.

Syntax

```
svcinflshowtimezone [-nohdr] [-delim delimiter]
```

Parameters

-nohdr

(Optional) Suppresses the display of these headings. By default, headings are displayed for each column of data (in a concise style view providing general

information about objects of a particular type) and for each item of data (in a detailed style view providing much more information about a specific object of a particular type).

Note: If there is no data to be displayed (for example, an empty view), headings are not displayed even if the **-nohdr** option was used.

-delim *delimiter*

(Optional) By default in a concise view, all columns of data are space-separated. The width of each column is set to the maximum possible width of each item of data. In a detailed view, each item of data has its own row, and if the headers are displayed, the data is separated from the header by a space. The **-delim** parameter overrides this behavior. Valid input for the **-delim** parameter is a one-byte character. If, for example, you entered **-delim ;**, a colon separates all items of data in a concise view (for example, the spacing of columns does not occur) and in a detailed view the data is separated from its header by a colon.

Description

This command displays a single time zone and its associated ID. This is the current time zone setting for the cluster. A list of available time-zones can be viewed by running the **svcinfo lstimezones** command. The time zone can be changed by running the **svctask settimezone** command.

Possible failures

- CMMVC5786E The action failed because the cluster is not in a stable state.
- CMMVC6252E The command failed authorization because the session SSH key is wrong or was deleted.
- CMMVC6253E The command failed authorization because the session SSH key does not have the requisite role.

An invocation example

```
svcinfo showtimezone -delim :
```

The resulting output

```
id:timezone  
522:UTC
```

Chapter 21. Error log commands

The following commands enable you to work with error logs for the SAN Volume Controller.

finderr

The **finderr** command analyzes the error log for the highest severity unfixed error.

Syntax

```
►►— svcservicetask — — finderr —————►►
```

Description

The command scans the error log for any unfixed errors. Given a priority ordering defined within the code, the highest priority unfixed error is returned to stdout.

You can use this command to determine the order in which to fix the logged errors.

The Web-based directed maintenance procedures (DMPs) also use this command.

Possible failures

- There are no error codes.

An invocation example

```
svcservicetask finderr
```

The resulting output

```
Highest priority unfixed error code is [1010]
```

dumperrlog

The **dumperrlog** command dumps the contents of the error log to a text file.

Syntax

```
►►— svcservicetask — — dumperrlog — [ -prefix — filename_prefix ] —►►
```

Parameters

-prefix *filename_prefix*

A file name is created from the prefix and a time stamp, and has the following format:

```
<prefix>_NNNNNN_YMMDD_HHMMSS
```

where *NNNNNN* is the node front panel name.

Note: If the `-prefix` parameter is not supplied, the dump will be directed to a file with a system-defined prefix of "errlog".

Description

When executed with no arguments, this command dumps the cluster error log to a file using a system-supplied prefix of "errlog", which includes the node ID and time stamp. When a file name prefix is provided, the same operation is performed but the details are stored in the dumps directory within a file with a name that starts with the specified prefix.

A maximum of ten error-log dump files are kept on the cluster. When the 11th dump is made, the oldest existing dump file is overwritten.

Error log dump files are written to `/dumps/elogs`. The contents of this directory can be viewed using the `svcinfolerrlogdumps` command.

Files **will not** be deleted from other nodes until you issue the `cleardumps` command.

Possible failures

- CMMVC5983E The dump file was not created. The file system might be full.
- CMMVC5984E The dump file was not written to disk. The file system might be full.

An invocation example

```
svcservicetask dumperrlog -prefix testerrorlog
```

The resulting output

No feedback

clearerrlog

The `clearerrlog` command clears all entries from the error log including status events and any unfixed errors.

Syntax

```
▶▶— svcservicetask — — clearerrlog — — [ -force ] —▶▶
```

Parameters

-force

(Optional) Specifies that the function of the `clearerrlog` command be processed without confirmation requests. If the `-force` parameter is not supplied, you are prompted to confirm that you want to clear the log.

Description

This command clears all entries from the error log. The entries are cleared even if there are unfixed errors in the log. It also clears any status events that are in the log.

Attention: This command is destructive. Use it only when you have either rebuilt the cluster or have fixed a major problem that has caused entries in the error log that you do not want to manually fix.

Possible failures

- CMMVC5786E The action failed because the cluster is not in a stable state.
- CMMVC6252E The command failed authorization because the session SSH key is wrong or was deleted.
- CMMVC6253E The command failed authorization because the session SSH key does not have the requisite role.

An invocation example

```
svcservicetask clearerrlog -force
```

The resulting output

No feedback

cherrstate

The **cherrstate** command marks an unfixed error as fixed. You can also use it to mark a fixed error as unfixed.

Syntax

```
▶— svcservicetask — — cherrstate — — -sequencenumber — sequence_number —▶  
▶ — [ -unfix ] —▶
```

Parameters

-sequencenumber *sequence_number*

(Required) Specifies the error log sequence numbers to fix or mark as unfixed.

-unfix

(Optional) Specifies that the sequence numbers that are supplied be marked as unfixed. If you specify the **-unfix** parameter, the sequence numbers are marked as unfixed. Use this parameter when you have marked the wrong sequence number as fixed.

Description

This command allows you to specify error log entries as fixed or unfixed. Use this command as a manual confirmation step that you have performed a maintenance procedure on the cluster, fabric, or subsystems.

This step is performed as part of the directed maintenance procedures (DMPs).

Optionally, if you have marked the wrong sequence number as fixed, you can use the **-unfix** parameter to change the entry to unfixed.

Possible failures

- CMMVC5786E The action failed because the cluster is not in a stable state.

- CMMVC5803E The entry in the error log was not marked because the sequence number was not found.
- CMMVC6252E The command failed authorization because the session SSH key is wrong or was deleted.
- CMMVC6253E The command failed authorization because the session SSH key does not have the requisite role.

An invocation example

```
svcservicetask cherrstate -sequencenumber 2019
```

The resulting output

No feedback

setevent

The **setevent** command specifies what happens when an error or event is logged to the error log.

Syntax

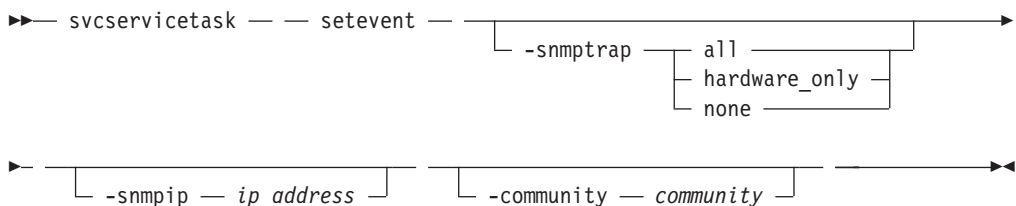

Parameters

-snmptrap *all | hardware_only | none*

(Optional) Specifies the SNMP trap setting, that is, when to raise a trap. You can set the following values for this parameter:

all Sends an SNMP trap for all errors and state changes that are logged.

hardware_only

Sends an SNMP trap for all errors, but not for object state changes.

none Does not send any SNMP traps or errors. This is the default setting for a new cluster.

-snmpip *ip_address*

(Optional) Specifies the IP address of the host system that is running the SNMP manager software. This is a colon-separated list of values with up to six items per list.

-community *community*

(Optional) Specifies the SNMP community string. This is a colon-separated list of values with up to six items per list. The maximum length of the community string that is used in SNMP trap generation cannot be more than 60 characters.

Description

This command sets or modifies the settings that you want to apply to the error log. These settings define what to do when errors and events are logged.

You can use this command to setup SNMP traps. For SNMP, you must supply the following information:

- When to raise a trap.
- The IP address of the SNMP manager
- The SNMP community

Possible failures

- CMMVC5786E The action failed because the cluster is not in a stable state.
- CMMVC6252E The command failed authorization because the session SSH key is wrong or was deleted.
- CMMVC6253E The command failed authorization because the session SSH key does not have the requisite role.

An invocation example

```
svcservicetask setevent -snmptrap all
```

The resulting output

No feedback

Chapter 22. Featurization commands

The following commands enable you to work with featurization functions with the SAN Volume Controller.

chlicense

The **chlicense** command changes the licensed settings of the cluster.

Syntax

```
svctask -- chlicense --
```

-flash	on
	off
-remote	on
	off
-size	capacity

Parameters

-flash *on* | *off*

(Optional) Specifies whether the FlashCopy feature is licensed for this cluster. Default is *off*.

-remote *on* | *off*

(Optional) Specifies whether the Metro Mirror feature is licensed for this cluster. Default is *off*.

-size *capacity*

(Optional) Specifies the amount of virtualization that is licensed for this cluster. Default is *0 GB*.

Note: You cannot use any of these parameter together.

Description

This command changes the license settings for the cluster. Any change that is made is logged as an event in the featurization log.

The current feature settings for the cluster are displayed in the viewing feature log panel. These settings show whether you are licensed to use either the FlashCopy or the Metro Mirror feature. They also show the amount of storage that you are licensed to virtualize. Normally, the feature log contains entries because feature options must be set as part of the Web-based cluster creation process.

Note: Dumping an empty feature log produces a file that contains headers, 256 lines of formatted zeros, and two lines that includes a checksum.

By default, the Copy Services functions are disabled, but this does not stop you from creating and using copy services. However, errors are placed in the featurization log which state that you are using an unlicensed feature. The command-line tool return code also notifies you that you are using an unlicensed feature.

The total virtualized capacity can also be modified with this command. This is the number of gigabytes (GB) of virtual disk capacity that can be configured by the cluster.

When you reach 90% capacity, any attempt to create or extend virtual disks results in a message from the command-line tool. This does not stop you from creating and expanding virtual disks. When usage reaches (and exceeds) 100% capacity, errors are placed in the featurization log. Again, this does not prevent you from creating and expanding virtual disks.

Any error that is placed in the featurization log results in a generic featurization error being placed in the normal cluster error log. These occur when you issue a command that breaks the license agreement. The return code also notifies you that you are breaking or exceeding the license settings, that is, a return code of 1 is displayed with any commands that exceed 90% or more or that breaks the current license settings.

Possible failures

- CMMVC5786E The action failed because the cluster is not in a stable state.
- CMMVC5998W The virtualized storage capacity exceeds the amount that you are licensed to use.
- CMMVC6252E The command failed authorization because the session SSH key is wrong or was deleted.
- CMMVC6253E The command failed authorization because the session SSH key does not have the requisite role.

An invocation example

```
svctask chlicense -flash on
```

The resulting output

No feedback

dumpinternallog

The **dumpinternallog** command dumps the contents of the featurization error and event log to a file on the current configuration node.

Syntax

```
▶▶ svctask — — dumpinternallog —————▶▶
```

Description

This command dumps the contents of the internal featurization error and event log to a file on the current configuration node.

This file is always called `feature.txt` and is created (or overwritten) in the `/dumps/feature` directory on the configuration node.

This file can be requested by IBM service personnel.

Before making any entries, the featurization log contains zeros. A dump of this log from the **svctask dumpinternallog** command results in an empty file.

Possible failures

- CMMVC5786E The action failed because the cluster is not in a stable state.
- CMMVC5983E The dump file was not created. The file system might be full.
- CMMVC6252E The command failed authorization because the session SSH key is wrong or was deleted.
- CMMVC6253E The command failed authorization because the session SSH key does not have the requisite role.

An invocation example

```
svctask dumpinternallog
```

The resulting output

No feedback

Chapter 23. Secure Shell key commands

The following commands enable you to work with Secure Shell (SSH) with the SAN Volume Controller.

addsshkey

The **addsshkey** command installs a new SSH key on the cluster. The key file must first be copied onto the cluster.

Syntax

```
svctask -- addsshkey -- -label identifier --  
-file filename_arg -- -user admin  
service
```

Parameters

-label *identifier*

(Required) Specifies a new identifier to associate with this key. The maximum length of this key is 30 characters.

-file *filename_arg*

(Required) Specifies the name of the file containing the SSH key.

-user *admin* | *service*

(Required) Specifies which user ID that the SSH key is assigned to.

Description

To add an SSH key to a cluster, you must first copy the key file to the cluster in the /tmp directory using secure copy (scp).

The **svctask addsshkey** command moves the key file from the /tmp directory to the required location and activates it for the designated user.

Each key is associated with an ID string that you define. The ID string can consist of up to 30 characters. Up to 100 keys can be stored on a cluster. You can add keys to provide either administrator access or service access.

When the key has been activated, you can invoke commands on the cluster over SSH using the user ID that was specified from the host for which the key was generated. Alternatively, you can run an interactive SSH session from the specified host using the user ID specified.

The identifier (key label) can be used to subsequently identify the key when all keys are listed using the **svctask lsshkeys** command, or if the key is to be deleted, using the **svctask rmsshkey** command.

The identifier is also specified as the key label that is used in the audit Log. The audit log uses the key label to identify the commands that were issued through an SSH session that was established with an associated key. If you want to use the

audit log, you must ensure that there is a 1:1 ratio mapping from the key label identifier to the key for each authorized user.

You can issue the **svcinfolssshkeys** command to list the SSH keys that are available on the cluster.

You can issue the **svctask rmsshkey** command to remove an SSH key from the cluster.

You can issue the **svctask rmallsshkeys** command to remove all of the SSH keys from the cluster

Possible failures

- CMMVC5786E The action failed because the cluster is not in a stable state.
- CMMVC6008E The key already exists.
- CMMVC6252E The command failed authorization because the session SSH key is wrong or was deleted.
- CMMVC6253E The command failed authorization because the session SSH key does not have the requisite role.

An invocation example

```
svctask addsshkey -user service -file /tmp/id_rsa.pub -label testkey
```

The resulting output

No feedback

rmallsshkeys

The **rmallsshkeys** command removes all the SSH keys that are specified by the **-user** parameter.

Syntax

```
svctask -- rmallsshkeys -- -user { admin | service | all }
```

Parameters

-user *admin* | *service* | *all*

(Required) Specifies which SSH keys to remove from the cluster. If you specify **-user all**, all the SSH keys in the cluster are removed.

Description

This command removes all the SSH keys that are specified by the **-user** parameter.

You can issue the **svcinfolssshkeys** command to list the SSH keys that are available on the cluster. You can issue the **svctask addsshkey** command to install a new SSH key on the cluster. The key file must first be copied onto the cluster. Each key is associated with an ID string that you define that can consist of up to 30 characters. Up to 100 keys can be stored on a cluster. You can add keys to provide either administrator access or service access. For example, type the following:

```
svctask addsshkey -user service -file /tmp/id_rsa.pub -label testkey
```

where */tmp/id_rsa.pub* is the name of the file that the SSH key is saved in and *testkey* is the label to associate with this key.

You can issue the **svctask rmsshkey** command to remove an SSH key from the cluster.

Possible failures

- CMMVC5786E The action failed because the cluster is not in a stable state.
- CMMVC6252E The command failed authorization because the session SSH key is wrong or was deleted.
- CMMVC6253E The command failed authorization because the session SSH key does not have the requisite role.

An invocation example

```
svctask rmallsshkeys -user service
```

The resulting output

No feedback

rmsshkey

The **rmsshkey** command removes a specified SSH key from the cluster.

Syntax

```
▶▶ svctask — — rmsshkey — — -user ———— [ admin ] —————▶  
                                     [ service ]  
▶ -key — key_identifier —————▶▶
```

Parameters

-user *admin* | *service*
(Required) Specifies the user ID from which the SSH key is deleted.

-key *key_identifier*
(Required) Specifies the label of the key to be deleted.

Description

This command removes the specified SSH key from the cluster.

CAUTION:

If you want to change your SSH key, you must add your new key before removing the old key. Within a current SSH session, once the SSH key that established the session is removed, that session is unable to issue any further commands. Adding your new key before removing the old key prevents inaccurate audit log entries.

You can issue the **svcinfo lsshkeys** command to list the SSH keys that are available on the cluster.

| You can issue the **svctask addsshkey** command to install a new SSH key on the
| cluster.

| You can issue the **svctask rmallsshkeys** command to remove all of the SSH keys
| from the cluster.

Possible failures

- CMMVC5786E The action failed because the cluster is not in a stable state.
- CMMVC6252E The command failed authorization because the session SSH key is wrong or was deleted.
- CMMVC6253E The command failed authorization because the session SSH key does not have the requisite role.

An invocation example

```
svctask rmsshkey -key testkey -user service
```

The resulting output

No feedback

Chapter 24. Service mode commands

Service mode commands perform tasks when the node is in service mode. Some of these tasks are specifying node software, cleaning dump directories and dumping the contents of an error log to a file.

These commands can only be run on a node that is in service mode. Attempting to run them on a working configuration node will result in the message:

CMMVC5997E This command can only be run on a node that is in service mode.

Attempting to run any of the other **svctask** and **svcservicetask** commands on a node that is in service mode will result in the following message:

CMMVC5998E This command can not be run on a node that is in service mode.

applysoftware

The **applysoftware** command upgrades the cluster to a new level of software.

Syntax

```
▶— svcservicemodetask — — applysoftware — — [ -force ] —————▶
▶ -file — filename_arg — — [ -ignore ] —————▶
```

Parameters

-force

Optionally specifies the force flag. The **-force** flag is needed if any node within an I/O group is not paired. The upgrade process forces the first node in each I/O group to shut down and upgrade. If that node is not paired, then the cluster will become degraded and the data will be lost.

-file *filename_arg*

Specifies the filename of the new software package.

-ignore

Optional parameter that, if used, will result in all prerequisite checking being bypassed and all hardened data to be deleted. This option should be used with care.

Description

This command starts the upgrade process of the cluster to a new level of software and can be applied to **svcservicetask** and **svcservicemodetask**. The **applysoftware** command can be used to apply a level of software to the node in both service and

non-service modes. In service mode the **applysoftware** command is applied to the specific node in service mode. In non-service mode, the command is applied to the complete cluster.

The software package as specified by the file name must first be copied on to the current configuration node in the /home/admin/upgrade directory. You can use PuTTY secure copy (scp) to copy the file. See “PuTTY scp” for detailed information on this procedure.

The actual upgrade completes asynchronously.

The contents of /home/admin/upgrade can be viewed by using the **svcinfo lssoftwaredumps** command.

Internally, the new package will be moved from the /home/admin/upgrade directory and checksummed. If the package fails the checksum, it will be deleted and the upgrade will fail. Otherwise, the package will be extracted from the directory and the software upgrade will begin.

Possible failures

- There are no error codes.

An invocation example

```
svcservicemodetask applysoftware -file newsoftware
```

The resulting output

No feedback

cleardumps

The **cleardumps** command cleans the various dump directories on a specified node.

Syntax

```
▶▶ svcservicemodetask — —cleardumps— —————▶▶
▶ -prefix — directory_or_file_filter — —————▶▶
                                     ┌ node_id ───┐
                                     └ node_name ───┘
```

Parameters

-prefix *directory_or_file_filter*

(Required) Specifies the directory, files, or both to be cleaned. If a directory is specified, with no file filter, all relevant dump or log files in that directory are cleaned. The directory arguments include:

- /dumps (cleans all files in all subdirectories)
- /dumps/audit
- /dumps/configs
- /dumps/elogs
- /dumps/feature
- /dumps/iostats

- /dumps/iotrace
- /home/admin/upgrade

In addition to the directory, a file filter can be specified. For example, if you specified /dumps/elogs/*.txt all files in the /dumps/elogs directory that end in .txt will be cleaned.

Note: The following rules apply to the use of wildcards with the SAN Volume Controller CLI:

- The wildcard character is an asterisk (*).
- The command can contain a maximum of one wildcard.
- When you use a wildcard, it is important to surround that filter entry with double quotes like the following example:

```
>svctask cleardumps -prefix "/dumps/elogs/*.txt"
```

node_id | node_name

(Optional) Specifies the node to be cleaned. The value that follows the flag is either:

- The node name which is the label that you assigned when you added the node to the cluster
- The node ID that is assigned to the node [not the worldwide node name (WWNN)].

Description

This command deletes all the files that match the directory/file_filter value for the node specified. If no node is specified, the configuration node is cleaned.

You can clean all the dumps directories by specifying /dumps as the directory value.

You can clean all the files in a single directory by specifying one of the directory values.

You can list the contents of these directories on the given node by using the **svcinfo lsxxx dumps** commands.

You can use this command to clean specific files in a given directory by specifying a directory or file name. You can use the wildcard (*) as part of your file name.

Note: In order to preserve the configuration and trace files, any files that match the following wildcard patterns are not cleaned:

- *svc.config*
- *.trc
- *.trc.old

Possible failures

- There are no error codes associated with the **svcserviceodetask cleardumps** command.

An invocation example

```
svcserviceodetask cleardumps -prefix /dumps/configs
```

The resulting output

dumperrlog

The **dumperrlog** command dumps the contents of the error log to a text file.

Syntax

```
▶— svcservicemodetask — — dumperrlog — — [ -prefix — filename_prefix ] ▶▶
```

Parameters

-prefix *filename_prefix*

(Optional) Creates a file name from the prefix and a time stamp, and has the following format:

```
<prefix>_NNNNNN_YMMDD_HHMMSS
```

where *NNNNNN* is the node front panel name.

Note: If the **-prefix** parameter is not supplied, the dump is directed to a file with a system-defined prefix of "errlog".

Description

When run with no parameters, this command dumps the cluster error log to a file using a system-supplied prefix of "errlog", which includes the node ID and time stamp. When a file name prefix is provided, the same operation is performed, but the details are stored in the dumps directory within a file with a name that starts with the specified prefix.

A maximum of ten error log dump files are kept on the cluster. When the 11th dump is made, the oldest existing dump file is overwritten.

Error log dump files are written to the /dumps/elogs directory. You can view the contents of this directory using the **svcinfolerrlogdumps** command.

Files are **not** deleted from other nodes until you issue the **cleardumps** command.

Possible failures

- CMMVC5983E The dump file was not created. The file system might be full.
- CMMVC5984E The dump file was not written to disk. The file system might be full.

An invocation example

```
svcservicemodetask dumperrlog -prefix testerrorlog
```

The resulting output

```
No feedback
```

exit

Use the **exit** command to exit service mode and to restart the node.

Syntax

▶▶— svcservicemodetask — — exit —————▶▶

Description

This command causes the node to be restarted. The node comes up in standard operating mode and attempts to rejoin the cluster.

At some point during the execution of this command, the SSH (secure shell) and the Web server connection that accessed the node are ended as a result of the restart.

Possible failures

- There are no error codes.

An invocation example

```
svcservicemodetask exit
```

The resulting output

```
[SSH / webservice connections terminate so an error message to the effect of  
'connection lost' may be displayed, or 'CLIENT RECEIVED SERVER DOWN  
NOTIFICATION']
```

Chapter 25. Service mode information commands

Service mode information commands perform information gathering tasks when the node is in service mode.

These commands can only be run on a node that is in service mode. Attempting to run them on a working configuration node will result in the message:

CMMVC5997E This command can only be run on a node that is in service mode.

Attempting to run any of the other `svcin` commands on a node that is in service mode will result in the following message:

CMMVC5998E This command can not be run on a node that is in service mode.

ls2145dumps

The `ls2145dumps` command obtains a list of node assert dumps and associated output files from the `/dumps` directory.

Syntax

```
▶▶▶ svc servicemodeinfo — — ls2145dumps — — [ -nohdr ] —————▶▶▶
▶ [ -delim — delimiter ] —————▶▶▶
```

Parameters

-nohdr

By default, headings are displayed for each column of data (in a concise style view), and each item of data (in a detailed style view). Using the `-nohdr` parameter will suppress the display of these headings.

Note: If there is no data to be displayed (for example, an empty view has been returned), then headings are not displayed irrespective of whether the `-nohdr` option was used or not.

-delim *delimiter*

By default in a concise view, all columns of data are space separated. The width of each column is set to the maximum possible width of each item of data. In a detailed view, each item of data has its own row, and if the headers are displayed the data is separated from the header by a space. Using the `-delim` parameter will override this behavior. Valid input for the `-delim` parameter is a one byte character. If, for example, you entered `-delim :` a colon will be used to separate all items of data in a concise view (for example, the spacing of columns does not occur) and in a detailed view the data is separated from its header by a colon.

Description

This command returns a list of node assert dumps and associated output files. These dumps are created as a result of the assertion of a node. If you do not specify a node, the dumps available on the configuration node will be listed. The command will display files from the /dumps directory.

Possible failures

- There are no error codes.

An invocation example

```
svcservicemodeinfo ls2145dumps -delim :
```

The resulting output

```
id:2145_filename  
0:000108.trc.old  
1:dump.000108.030328.144007  
2.000108.trc
```

lsclustervpd

You can use the lsclustervpd command to return the vital product data (VPD) for the cluster to which the node belonged.

Syntax

```
▶— svcservicemodeinfo — — lsclustervpd — — [ -nohdr ] —————▶  
▶ [ -delim — delimiter ] —————▶
```

Parameters

-nohdr

By default, headings are displayed for each column of data (in a concise style view), and each item of data (in a detailed style view). Using the -nohdr parameter will suppress the display of these headings.

Note: If there is no data to be displayed (for example, an empty view has been returned), then headings are not displayed irrespective of whether the -nohdr option was used or not.

-delim *delimiter*

By default in a concise view, all columns of data are space separated. The width of each column is set to the maximum possible width of each item of data. In a detailed view, each item of data has its own row, and if the headers are displayed the data is separated from the header by a space. Using the -delim parameter will override this behavior. Valid input for the -delim parameter is a one byte character. If, for example, you entered -delim : a colon will be used to separate all items of data in a concise view (for example, the spacing of columns does not occur) and in a detailed view the data is separated from its header by a colon.

Description

This command displays the VPD of the cluster to which the node belonged.

Possible failures

- There are no error codes.

An invocation example

```
svcservicemodeinfo lsclustervpd
```

The resulting output

```
id 000001002FF007E5
name kkk
location local
partnership
bandwidth 0
cluster_IP_address 0.0.0.0
cluster_service_IP_address 1.1.1.1
total_mdisk_capacity 0
space_in_mdisk_grps 0
space_allocated_to_vdisks 0
total_free_space 0
statistics_status off
statistics_frequency 15
required_memory 2048
cluster_locale en_US
SNMP_setting all
SNMP_community
SNMP_server_IP_address 0.0.0.0
subnet_mask 0.0.0.0
default_gateway 0.0.0.0
time_zone 522 UTC
email_setting all
email_id
code_level 00000000
FC_port_speed 1Gb
gm_link_tolerance:300
gm_inter_cluster_delay_simulation:0
gm_intra_cluster_delay_simulation:0
```

lserrlogdumps

The **lserrlogdumps** commands return a list of error log dumps in the `/dumps/elog` directory. These dumps are created as a result of issuing the **svctask dumperrlog** command.

Syntax

```
▶▶— svcservicemodeinfo — — lserrlogdumps — —————▶▶
└── -nohdr ─┘
└── -delim — delimiter ─┘
```

Parameters

-nohdr

By default, headings are displayed for each column of data (in a concise style view), and each item of data (in a detailed style view). Using the `-nohdr` parameter will suppress the display of these headings.

Note: If there is no data to be displayed (for example, an empty view has been returned), then headings are not displayed irrespective of whether the `-nohdr` option was used or not.

-delim *delimiter*

By default in a concise view, all columns of data are space separated. The width of each column is set to the maximum possible width of each item of data. In a detailed view, each item of data has its own row, and if the headers are displayed the data is separated from the header by a space. Using the `-delim` parameter will override this behavior. Valid input for the `-delim` parameter is a one byte character. If, for example, you entered `-delim :` a colon will be used to separate all items of data in a concise view (for example, the spacing of columns does not occur) and in a detailed view the data is separated from its header by a colon.

Description

This command returns a list of error log dumps. These dumps are created as a result of issuing the `svctask dumperrlog` command. An error log dump describes the contents of the error log at the time that the command was executed. If you do not specify a node, the dumps available on the configuration node will be listed. The command will display files from the `/dumps/elogs` directory.

Possible failures

- There are no error codes.

An invocation example

```
svcservicemodeinfo lserrlogdumps
```

The resulting output

id	filename
0	errlog_lynn02_030327_154511
1	aaa.txt_lynn02_030327_154527
2	aaa.txt_lynn02_030327_154559
3	errlog_lynn02_030403_110628

lsfeaturedumps

The `lsfeaturedumps` command returns a list of dumps in `/dumps/feature`. These dumps are created as a result of issuing the `svctask dumpinternallog` command.

Syntax

```
svcservicemodeinfo -- lsfeaturedumps -- [-nohdr]
[-delim -- delimiter]
```

Parameters

-nohdr

By default, headings are displayed for each column of data (in a concise style view), and each item of data (in a detailed style view). Using the `-nohdr` parameter will suppress the display of these headings.

Note: If there is no data to be displayed (for example, an empty view has been returned), then headings are not displayed irrespective of whether the `-nohdr` option was used or not.

-delim *delimiter*

By default in a concise view, all columns of data are space separated. The width of each column is set to the maximum possible width of each item of data. In a detailed view, each item of data has its own row, and if the headers are displayed the data is separated from the header by a space. Using the `-delim` parameter will override this behavior. Valid input for the `-delim` parameter is a one byte character. If, for example, you entered `-delim :` a colon will be used to separate all items of data in a concise view (for example, the spacing of columns does not occur) and in a detailed view the data is separated from its header by a colon.

Description

This command returns a list of featurization dumps. These dumps are created as a result of issuing the `svctask dumpinternallog` command. A featurization dump file describes the contents of the featurization log at the time that the command was executed. If you do not specify a node, the dumps available on the configuration node will be listed. The command will display files from the `/dumps/feature` directory.

Issue the `svcinfolfeaturedumps` command to return a list of dumps in the `/dumps/feature` destination directory. The feature log is maintained by the cluster. The feature log records events that are generated when license parameters are entered or when the current license settings have been breached.

Possible failures

- There are no error codes.

An invocation example

```
svcservicemodeinfo lsfeaturedumps
```

The resulting output

```
id          feature_filename
0           feature.txt
```

lsiostatsdumps

The `lsiostatsdumps` command returns a list of dumps in the `/dumps/iostats` directory. These dumps are created as a result of issuing the `svctask startstats` command.

Syntax

```
▶▶ svcservicemodeinfo -- lsiostatsdumps -- [ -nohdr ] ▶▶
▶ [ -delim delimiter ] ▶▶
```

Parameters

-nohdr

By default, headings are displayed for each column of data (in a concise style view), and each item of data (in a detailed style view). Using the `-nohdr` parameter will suppress the display of these headings.

Note: If there is no data to be displayed (for example, an empty view has been returned), then headings are not displayed irrespective of whether the `-nohdr` option was used or not.

-delim delimiter

By default in a concise view, all columns of data are space separated. The width of each column is set to the maximum possible width of each item of data. In a detailed view, each item of data has its own row, and if the headers are displayed the data is separated from the header by a space. Using the `-delim` parameter will override this behavior. Valid input for the `-delim` parameter is a one byte character. If, for example, you entered `-delim :` a colon will be used to separate all items of data in a concise view (for example, the spacing of columns does not occur) and in a detailed view the data is separated from its header by a colon.

Description

This command returns a list of I/O statistics dumps. These dumps are created as a result of issuing the `svctask startstats` command. If you do not specify a node, the dumps available on the configuration node will be listed. The command will display files from the `/dumps/iostats` directory.

Possible failures

- There are no error codes.

An invocation example

```
svcservicemodeinfo lsiostatsdumps
```

The resulting output

```
id          iostat_filename
0           v_stats_mala75_031123_072426
1           m_stats_mala75_031123_072425
```

lsiotracedumps

You can use the `lsiotracedumps` command to return a list of files in the `/dumps/iotrace` directory.

Syntax

```
▶▶▶ svcservicemodeinfo -- lsiotracedumps -- [ -nohdr ] ▶▶▶
▶ [ -delim delimiter ] ▶▶▶
```

Parameters

-nohdr

By default, headings are displayed for each column of data (in a concise style view), and each item of data (in a detailed style view). Using the `-nohdr` parameter will suppress the display of these headings.

Note: If there is no data to be displayed (for example, an empty view has been returned), then headings are not displayed irrespective of whether the `-nohdr` option was used or not.

-delim delimiter

By default in a concise view, all columns of data are space separated. The width of each column is set to the maximum possible width of each item of data. In a detailed view, each item of data has its own row, and if the headers are displayed the data is separated from the header by a space. Using the `-delim` parameter will override this behavior. Valid input for the `-delim` parameter is a one byte character. If, for example, you entered `-delim :` a colon will be used to separate all items of data in a concise view (for example, the spacing of columns does not occur) and in a detailed view the data is separated from its header by a colon.

Description

This command returns a list of I/O trace dumps. These dumps are created as a result of issuing the `svctask settrace` command. If you do not specify a node, the dumps available on the configuration node will be listed. The command will display files from the `/dumps/iotrace` directory.

Possible failures

- There are no error codes.

An invocation example

```
svcserviceinfo |siotracedumps
```

The resulting output

id	iotrace_filename
0	c1_mala75_030405_092155
1	c2_mala75_030405_092156
2	c3_mala75_030405_092158
3	c4_mala75_030405_092159
4	c5_mala75_030405_092201

Isnodes

The `Isnodes` command will return an annotated list of the nodes in the cluster in service mode.

The list report style can be used to obtain two styles of report.

1. A list containing concise information about all the nodes on a cluster. (Each entry in the list corresponds to a single node.)
2. The detailed information about a single node.

Syntax

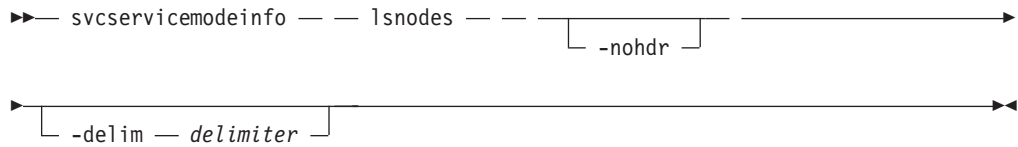

Parameters

-nohdr

By default, headings are displayed for each column of data (in a concise style view), and each item of data (in a detailed style view). Using the -nohdr parameter will suppress the display of these headings.

Note: If there is no data to be displayed (for example, an empty view has been returned), then headings are not displayed irrespective of whether the -nohdr option was used or not.

-delim *delimiter*

By default in a concise view, all columns of data are space separated. The width of each column is set to the maximum possible width of each item of data. In a detailed view, each item of data has its own row, and if the headers are displayed the data is separated from the header by a space. Using the -delim parameter will override this behavior. Valid input for the -delim parameter is a one byte character. If, for example, you entered -delim : a colon will be used to separate all items of data in a concise view (for example, the spacing of columns does not occur) and in a detailed view the data is separated from its header by a colon.

Description

This command returns an annotated list of nodes in the cluster.

Possible failures

- There are no error codes.

A concise invocation example

```
svc servicemodeinfo lsnodes -delim :
```

The concise resulting output

```
id:WWNN:front_panel_id:node_name:cluster:fabric
1:50050768010007E5:lynn02:node1:yes:yes
```

lsnodevpd

The **lsnodevpd** command returns the vital product data (VPD) for the given node.

Syntax

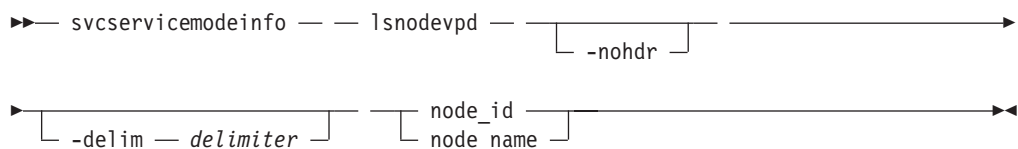

Parameters

-nohdr

By default, headings are displayed for each column of data (in a concise style view), and each item of data (in a detailed style view). Using the `-nohdr` parameter will suppress the display of these headings.

Note: If there is no data to be displayed (for example, an empty view has been returned), then headings are not displayed irrespective of whether the `-nohdr` option was used or not.

-delim delimiter

By default in a concise view, all columns of data are space separated. The width of each column is set to the maximum possible width of each item of data. In a detailed view, each item of data has its own row, and if the headers are displayed the data is separated from the header by a space. Using the `-delim` parameter will override this behavior. Valid input for the `-delim` parameter is a one byte character. If, for example, you entered `-delim :` a colon will be used to separate all items of data in a concise view (for example, the spacing of columns does not occur) and in a detailed view the data is separated from its header by a colon.

node_id | node_name

Specifies the node to view in terms of its node ID or name.

Description

This command returns the VPD for the specified node. Each field is reported on a new line. All fields are strings. The VPD is split into sections. Each section has a section heading. Following the heading is the number of fields in that section. Each section is separated by an empty line. For example:

```
section name:3 fields
field1:value
field2:value
field3:value
```

```
new section:x fields
...
```

Some sections contain information about multiple objects of that type. Each object within the section is separated by an empty line. For example:

```
section name:4 fields
object1 field1:value
object1 field2:value
```

```
object2 field1:value
object2 field2:value
```

```
new section: x fields
...
```

Note: The VPD for an 8F4 node displays the device serial number of the FC card as N/A.

Possible failures

- There are no error codes.

An invocation example

```
svcservicemodeinfo lsnodevpd id 1
```

The resulting output

```
id 1
```

```
system board: 17 fields
```

```
part_number Unknown
system_serial_number 550117N
number_of_processors 2
number_of_memory_slots 4
number_of_fans 0
number_of_FC_cards 1

number_of_scsi/ide_devices 2
BIOS_manufacturer IBM
BIOS_version -[QAE115AUS-1.01]-
BIOS_release_date 08/16/2001
system_manufacturer IBM
system_product eserver xSeries 342 -[86691RX]-
planar_manufacturer IBM
power_supply_part_number Unknown
CMOS_battery_part_number Unknown
power_cable_assembly_part_number Unknown
service_processor_firmware N/A
```

```
processor: 6 fields
processor_location Processor 1
number_of_caches 2
```

```
manufacturer GenuineIntel
version Pentium III
speed 1000
status Enabled
processor cache: 4 fields
type_of_cache Internal L1 Cache
size_of_cache (KB) 32
```

```
type_of_cache Internal L2 Cache
size_of_cache (KB) 256
```

```
processor: 6 fields
processor_location Processor 2
number_of_caches 2
manufacturer GenuineIntel
version Pentium III
speed 1000
status Enabled
```

```
processor cache: 4 fields
type_of_cache Internal L1 Cache
size_of_cache (KB) 32
```

```
type_of_cache Internal L2 Cache
size_of_cache (KB) 256
memory module: 16 fields
part_number 33L5039
device_location J1
bank_location Slot1 in bank 1
size (MB) 1024
part_number 33L5039
```

```

device_location J4
bank_location Slot2 in bank 1
size (MB) 1024

part_number N/A
device_location J2
bank_location Slot1 in bank 2
size (MB) 0

part_number N/A
device_location J3
bank_location Slot2 in bank 2
size (MB) 0

FC card: 5 fields
part_number 64P7783
port_numbers 1 2
device_serial_number VSI 0000AD3F4
manufacturer Agilent
device DX2
device: 15 fields
part_number Unknown
bus ide0
device 0
model LG CD-ROM CRN-8245B
revision 1.13
serial_number
approx_capacity 0
part_number Unknown
bus scsi
device 0
device_vendor IBM-ESXS
model ST318305LC !#
revision 6C48
serial_number 3JKQ93B903196C48
approx_capacity 8
software: 5 fields
code_level 00000000
node_name node1
ethernet_status 1
WWNN 0x50050768010007e5

id 1

front panel assembly: 3 fields
part_number Unknown
front_panel_id lynn02
front_panel_locale en_US

UPS: 10 fields
electronics_assembly_part_number FakElec
battery_part_number FakBatt
frame_assembly_part_number FakFram
input_power_cable_part_number FakCabl
UPS_serial_number UPS_Fake_SN
UPS_type Fake UPS
UPS_internal_part_number UPS_Fake_PN
UPS_unique_id 0x10000000000007e5
UPS_main_firmware 1.4
UPS_comms_firmware 0.0

```

Issoftwaredumps

You can use the **Issoftwaredumps** command to return a list of software packages from the `/home/admin/upgrade` directory.

Syntax

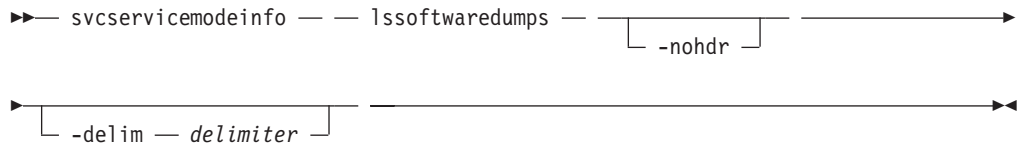

Parameters

-nohdr

By default, headings are displayed for each column of data (in a concise style view), and each item of data (in a detailed style view). Using the `-nohdr` parameter will suppress the display of these headings.

Note: If there is no data to be displayed (for example, an empty view has been returned), then headings are not displayed irrespective of whether the `-nohdr` option was used or not.

-delim *delimiter*

By default in a concise view, all columns of data are space separated. The width of each column is set to the maximum possible width of each item of data. In a detailed view, each item of data has its own row, and if the headers are displayed the data is separated from the header by a space. Using the `-delim` parameter will override this behavior. Valid input for the `-delim` parameter is a one byte character. If, for example, you entered `-delim :` a colon will be used to separate all items of data in a concise view (for example, the spacing of columns does not occur) and in a detailed view the data is separated from its header by a colon.

Description

This command returns a list of software upgrade packages. These packages are copied across as a result of software upgrades. If you do not specify a node, the packages available on the configuration node will be listed. The command will display files from the `/home/admin/upgrade` directory.

Possible failures

- There are no error codes.

An invocation example

```
svcserviceinfo lssoftwaredumps
```

The resulting output

```
id          software_filename
0           s1_mala75_030405_092143
1           s2_mala75_030405_092145
2           s3_mala75_030405_092146
```

Chapter 26. Controller command

The following command enables you to work with controllers in the SAN Volume Controller.

chcontroller

Use the **chcontroller** command to modify the name of a controller.

Syntax

```
svctask -- chcontroller -- -name -- new_name --  
└─ controller_id ─┘  
└─ controller_name ─┘
```

Parameters

-name *new_name*

(Required) Specifies the new name to be assigned to the controller.

controller_id | **controller_name**

(Required) Specifies which controller is to be modified. Use either the name or the ID.

Description

This command changes the name of the controller that is specified by the **controller_id** or the **controller_name** parameter to the controller that is specified by the **-name** parameter.

You can add a new disk controller system to your SAN at any time. Follow the switch zoning guidelines in the section about switch zoning. Also, ensure that the controller is set up correctly for use with the cluster.

You should create one or more arrays on the new controller. It is recommended that you use RAID-5, RAID-1 or RAID-0+1 (sometimes called RAID-10) for maximum redundancy and reliability. Generally 5+P arrays are recommended. If your controller provides array partitioning, you can create a single partition from the entire capacity available in the entire capacity that is available in the array. Record the LUN number that you assign to each partition because you will need this later. Also, follow the mapping guidelines (if your disk controller system requires LUN mapping) to map the partitions or the arrays to the cluster ports.

Adding a new disk controller system to a running configuration: Ensure that the cluster has detected the new storage (MDisks) by issuing the **svctask detectmdisk** command. The controller itself has automatically been assigned a default name. If you are unsure which controller is presenting the MDisks, issue the **svcinfo lscontroller** command to list the controllers. You will see the new controller listed (the one with the highest numbered default name). Record the controller name and follow the instructions in the section about determining a disk controller system name.

Give this controller a name that you can easily use to identify it. Issue the following command:

```
svctask chcontroller -name <newname> <oldname>
```

List the unmanaged MDisks by issuing the following command:

```
svcinfo lsmdisk -filtervalue mode=unmanaged:controller_name=<new_name>
```

These MDisks correspond with the RAID arrays or partitions that you have created. Record the field controller LUN number. The field controller LUN number corresponds with the LUN number that you assigned to each of the arrays or partitions.

Create a new managed disk group and add only the RAID arrays that belong to the new controller to this MDisk group. Avoid mixing RAID types; for each set of RAID array types (for example, RAID-5 or RAID-1 and so forth), create a new MDisk group. Give this MDisk group an appropriate name, so that if your controller is called FAST650-fred and the MDisk group contains RAID-5 arrays, call it something like F600-fred-R5. Issue the following command:

```
svctask mkmdiskgrp -ext 16 -name <mdisk_grp_name>  
-mdisk <colon separated list of RAID-x mdisks returned  
in step 4.
```

Note: This creates a new MDisk group with an extent size of 16 MB.

Possible failures

- CMMVC5786E The action failed because the cluster is not in a stable state.
- CMMVC5816E The action failed because an entity that was specified in the command does not exist.
- CMMVC6252E The command failed authorization because the session SSH key is wrong or was deleted.
- CMMVC6253E The command failed authorization because the session SSH key does not have the requisite role.

An invocation example

```
svctask chcontroller -name newtwo 2
```

The resulting output

No feedback

Chapter 27. Command-line interface messages

The command line tools will return a return value on completion. If the command completes normally and without error, then the return code will be 0. If the command fails then the return code will be 1 and Error Code will be printed on stderr. If the command succeeds, but the cluster is operating close to its licensed virtualization limit, then the return code may still be 1, and a warning Error Code will be printed to stderr.

When a create command is issued, the message ID that has been assigned to the new object is returned as part of the success message sent to stdout. If the -quiet command is used, only the message ID is sent to stdout.

CMMVC5000I No message was found for major rc *MAJOR_RC*, minor rc *MINOR_RC*, for action/view id *ACTION_VIEW_ID*.

Explanation

A message is missing.

Action

Contact the support center.

CMMVC5700E The parameter list is not valid.

Action

Specify the correct parameter list and reissue the command.

CMMVC5701E No object ID was specified.

Explanation

An object ID was not specified.

Action

Specify an object ID and reissue the command.

CMMVC5702E [%1] is below the minimum level.

Explanation

[%1] is below the minimum level.

Action

Specify the correct level and reissue the command.

CMMVC5703E [%1] is above the maximum level.

Explanation

[%1] is above the maximum level.

Action

Specify the correct level and reissue the command.

CMMVC5704E [%1] is not divisible by the permitted step level.

Explanation

[%1] is not divisible by the permitted step level.

Action

Not applicable.

CMMVC5705E A required parameter is missing.

Explanation

A required parameter is missing.

Action

Specify the required parameter and reissue the command.

CMMVC5706E An invalid argument has been entered for the [%1] parameter.

Explanation

[%1] is not a valid argument for the specified parameter.

Action

Specify the correct argument and reissue the command.

CMMVC5707E There are required parameters that are missing.

Explanation

There are required parameters that are missing.

Action

Specify the required parameters and reissue the command.

CMMVC5708E The %1 parameter is missing its associated arguments.

Explanation

The [%1] parameter is missing its associated arguments.

Action

Specify the associated arguments and reissue the command.

CMMVC5709E [%1] is not a supported parameter.

Explanation

[%1] is not a supported parameter.

Action

Specify the correct parameter and reissue the command.

CMMVC5710E No self describing structure for identifier parameter [%1].

Explanation

There is no self describing structure for the identifier parameter [%1].

Action

Not applicable.

CMMVC5711E [%1] is not valid data.

Explanation

[%1] is not valid data.

Action

Not applicable.

CMMVC5712E Required data is missing.

Explanation

There is required data that is missing.

Action

Specify the missing data and reissue the command.

CMMVC5713E There are some parameters which are mutually exclusive.

Explanation

There are some parameters which are mutually exclusive.

Action

Not applicable.

CMMVC5714E There are no items in the parameter list.

Explanation

There are no items in the parameter list.

Action

Specify an item in the parameter list and reissue the command.

CMMVC5715E There is no parameter list.

Explanation

There is no parameter list.

Action

Not applicable.

CMMVC5716E Nonnumeric data was entered for a numeric field ([%1]). Enter a numeric value.

Explanation

Nonnumeric data was specified for a numeric field.

Action

Specify a numeric value in the numeric field and reissue the command.

CMMVC5717E No match was found for the specified unit.

Explanation

No match was found for the specified unit.

Action

Specify the correct unit and reissue the command.

CMMVC5718E An unexpected return code was received.

Explanation

An unexpected return code was received.

Action

Not applicable.

CMMVC5719E A value of %2 requires the parameter %1 to be specified.

Explanation

A value of %2 requires the parameter %1 to be specified.

Action

Specify the required parameter and reissue the command.

CMMVC5720E [%1] is not a valid argument for the -o parameter.

Explanation

[%1] is not a valid argument for the -o parameter.

Action

Specify the correct argument and reissue the command.

CMMVC5721E [%1] is not a valid time-stamp format. The valid format is MMDDHHmmYYYY.

Explanation

[%1] is not a valid time-stamp format. The valid format is MMDDHHmmYYYY.

Action

Follow the correct time-stamp format and reissue the command.

CMMVC5722E [%1] is not a valid month.

Explanation

[%1] is not a valid month.

Action

Specify the correct month (MM) and reissue the command.

CMMVC5723E [%1] is not a valid day.**Explanation**

[%1] is not a valid day.

Action

Specify the correct day (DD) and reissue the command.

CMMVC5724E [%1] is not a valid hour.**Explanation**

[%1] is not a valid hour.

Action

Specify the correct hour (HH) and reissue the command.

CMMVC5725E [%1] is not a valid minute.**Explanation**

[%1] is not a valid minute.

Action

Specify the correct minute (mm) and reissue the command.

CMMVC5726E [%1] are not valid seconds.**Explanation**

[%1] are not valid seconds.

Action

Specify the correct seconds (ss) and reissue the command.

CMMVC5727E [%1] is not a valid filter.**Explanation**

[%1] is not a valid filter.

Action

The value used in the -filtervalue parameter was not a recognized filter value. Refer to the help for a list of valid filters.

**CMMVC5728E [%1] should be in the format
minute:hour:day:month:weekday.**

Explanation

[%1] should be in the format minute:hour:day:month:weekday.

Action

Follow the correct format and reissue the command.

CMMVC5729E One or more components in the list is not valid.

Explanation

One or more components that were specified are not valid.

Action

Specify the correct component and reissue the command.

CMMVC5730E %1 is only valid when %2 has a value of %3.

Explanation

%1 is only valid when %2 has a value of %3.

Action

Not applicable.

CMMVC5731E %1 can only be entered when %2 has been entered.

Explanation

%1 can only be entered when %2 has been entered.

Action

Not applicable.

CMMVC5732E The shared-memory interface is not available.

Explanation

The shared memory interface (SMI) is not available.

Action

Not applicable.

CMMVC5733E Enter at least one parameter.

Explanation

At least one parameter needs to be specified.

Action

Specify the correct parameter and reissue the command.

CMMVC5734E A combination of values was entered that is not valid.

Explanation

A combination of values were specified that are not valid.

Action

Specify the correct combination of values and reissue the command.

CMMVC5735E The name entered is not valid. Enter an alphanumeric string that does not start with a number.

Explanation

A name was specified that is not valid.

Action

Specify an alphanumeric string that does not start with a numeric.

CMMVC5736E -c is not a valid unit.

Explanation

A parameter was specified that is not a valid unit.

Action

Specify the correct parameter and reissue the command.

CMMVC5737E The parameter %1 has been entered multiple times. Enter the parameter once.

Explanation

The same parameter was specified more than once.

Action

Delete any duplicate parameters and reissue the command.

CMMVC5738E The name contains too many characters. Enter an alphanumeric string of 1 - 15 characters that is composed of any of the following characters: A - Z, a - z, 0 - 9, -, or _. The first character cannot be a number.

Explanation

An argument was specified that contains too many characters.

Action

Specify the correct argument and reissue the command.

CMMVC5739E The argument %1 does not contain enough characters.

Explanation

An argument was specified that does not contain enough characters.

Action

Specify the correct argument and reissue the command.

CMMVC5740E The filter flag %1 is not valid.

Explanation

The filter flag %1 is not valid.

Action

Specify the correct flag and reissue the command.

CMMVC5741E The filter value %1 is not valid.

Explanation

The filter value %1 is not valid.

Action

Specify the correct value and reissue the command.

CMMVC5742E A specified parameter is out of its valid range.

Explanation

A parameter was specified that is out of its valid range.

Action

Specify the correct parameter and reissue the command.

CMMVC5743E A specified parameter does not comply with the step value.

Explanation

A parameter was specified that does not comply with the step value.

Action

Specify the correct parameter and reissue the command.

CMMVC5744E Too many objects were specified in the command.

Explanation

There were too many objects specified in the command.

Action

Specify the correct object and reissue the command.

CMMVC5745E Not enough objects were specified in the command.

Explanation

There were not enough objects specified in the command.

Action

Specify the correct object and reissue the command.

CMMVC5746E The operation that was requested is not valid for the this object.

Explanation

The requested operation is not valid for this object.

Action

Specify a valid operation and reissue the command.

CMMVC5747E The operation that was requested is not valid.

Explanation

The operation that was requested is not valid.

Action

Specify the correct operation and reissue the command.

CMMVC5748E The operation that was requested is not valid.

Explanation

The operation that was requested is not valid.

Action

Specify the correct operation and reissue the command.

CMMVC5749E The dump file name that was specified already exists.

Explanation

The dump file name that was specified already exists.

Action

Specify a different dump file name and reissue the command.

CMMVC5750E The dump file was not created. The file system might be full.

Explanation

The dump file was not created. The file system might be full.

Action

Not applicable.

CMMVC5751E The dump file could not be written to disk.

Explanation

The dump file could not be written to disk.

Action

Not applicable.

CMMVC5752E The operation failed because the object contains child objects. Delete the child objects and then resubmit the request.

Explanation

The operation failed because the specified object contains child objects.

Action

Delete the child objects and reissue the command.

CMMVC5753E The specified object does not exist or is not a suitable candidate.

Explanation

The specified object does not exist or is not a suitable candidate.

Action

Specify the correct object and reissue the command.

CMMVC5754E The specified object does not exist, or the name does not meet the naming rules.

Explanation

The specified object does not exist, or the name of the object does not meet the naming requirements.

Action

Specify the correct object name and reissue the command.

CMMVC5755E The sizes of the specified objects do not match.

Explanation

The sizes of the specified objects do not match.

Action

Not applicable.

CMMVC5756E The operation failed because the object is already mapped.

Explanation

The operation failed because the specified object is already mapped.

Action

Specify a different object and reissue the command.

CMMVC5757E The defaults for the self describing structure were not found.

Explanation

The defaults for the self describing structure were not found.

Action

Not applicable.

CMMVC5758E The object filename already exists.

Explanation

The object filename already exists.

Action

Specify a different object filename and reissue the command.

CMMVC5759E The memory cannot be allocated.

Explanation

The memory cannot be allocated.

Action

Not applicable.

CMMVC5760E The node could not be added to the cluster.

Explanation

The node could not be added to the cluster.

Action

Not applicable.

CMMVC5761E The node could not be deleted from the cluster.

Explanation

The node could not be deleted from the cluster.

Action

Not applicable.

CMMVC5762E The operation failed because the timeout period expired.

Explanation

The operation failed because the timeout period expired.

Action

Reissue the command.

CMMVC5763E The node failed to go online.

Explanation

The node failed to go online.

Action

Not applicable.

CMMVC5764E The specified mode change is not valid.

Explanation

The specified mode change is not valid.

Action

Specify a different mode and reissue the command.

CMMVC5765E The select object is no longer a candidate. A change occurred during the request.

Explanation

The specified object is no longer a candidate. A change occurred during the request.

Action

Specify a different object and reissue the command.

CMMVC5767E One or more of the specified parameters is not valid.

Explanation

One or more of the specified parameters is not valid.

Action

Specify the correct parameter and reissue the command.

CMMVC5769E The operation requires that all nodes be online. One or more nodes are not online.

Explanation

The operation requires that all nodes be online. One or more nodes are not online.

Action

Check that each node is online and reissue the command.

CMMVC5770E The file for the ssh key is not valid.

Explanation

The file for the ssh key is not valid.

Action

Specify a different file and reissue the command.

CMMVC5771E The operation failed because the object contains child objects. To complete the operation, specify the -force flag.

Action

Specify the -force flag to complete the operation and then reissue the command.

CMMVC5772E The operation failed because a software upgrade is in progress.

Explanation

The operation failed because a software upgrade is in progress.

Action

Wait for the software upgrade to complete and then reissue the command.

CMMVC5773E The operation failed because the selected object is in the wrong mode.

Explanation

The operation failed because the selected object is in the wrong mode.

Action

Specify the correct mode and reissue the command.

CMMVC5774E The userid is not valid.

Explanation

The userid is not valid.

Action

Specify a different userid and reissue the command.

CMMVC5775E The directory attribute is not valid.

Explanation

The directory attribute is not valid.

Action

Specify a different directory and reissue the command.

CMMVC5776E The directory listing could not be retrieved.**Explanation**

The directory listing could not be retrieved.

Action

Specify a different directory listing and reissue the command.

CMMVC5777E The node was not added to the I/O group because the other node in the I/O Group is in the same power domain.**Explanation**

The node was not added to the I/O group because the other node in the I/O Group is in the same power domain.

Action

Specify a different node from another I/O group and reissue the command.

CMMVC5778E The cluster was not created because one already exists.**Explanation**

The cluster was not created because one already exists.

Action

Not applicable.

CMMVC5780E The action could not be completed using the Remote Cluster name. Use the Remote Cluster Unique ID instead.**Explanation**

The unique ID of the remote cluster is required for this command.

Action

Specify the unique ID of the remote cluster, and reissue the command.

CMMVC5781E The cluster ID specified is invalid.**Explanation**

The cluster ID is not valid.

Action

Specify a different cluster ID and reissue the command.

CMMVC5782E The object is offline.**Explanation**

The object is offline.

Action

Specify an object that is online and reissue the command.

CMMVC5783E The information is not available to complete this command.**Explanation**

This error is only returned when the node is in service mode.

Action

None.

CMMVC5784E The cluster name is not unique. Specify the cluster using the cluster ID.**Explanation**

The cluster name is not unique.

Action

Specify the cluster using the cluster ID and reissue the command.

CMMVC5785E The filename contains an illegal character.**Explanation**

The filename contains an illegal character.

Action

Specify a valid filename and reissue the command.

CMMVC5786E The action failed because the cluster is not in a stable state.**Explanation**

The action failed because the cluster is not in a stable state.

Action

Not applicable.

CMMVC5787E The cluster was not created because a cluster already exists.

Explanation

The cluster was not created because a cluster already exists.

Action

Not applicable.

CMMVC5788E The service IP address is not valid.

Explanation

The service IP address is not valid.

Action

Specify the correct service IP address and reissue the command.

CMMVC5789E The cluster was not modified because the IP address, subnet mask, service address, SNMP address, or gateway address is not valid.

Explanation

The cluster was not modified because the IP address, subnet mask, service address, SNMP address, or gateway address is not valid.

Action

Specify all correct attributes and reissue the command.

CMMVC5790E The node was not added to the cluster because the maximum number of nodes has been reached.

Explanation

The node was not added to the cluster because the maximum number of nodes has been reached.

Action

Not applicable.

CMMVC5791E The action failed because an entity that was specified in the command does not exist.

Explanation

An entity that was specified in the command does not exist, therefore the action failed.

Action

Specify the correct entity and reissue the command.

CMMVC5792E The action failed because the I/O group is used for recovery.

Explanation

The action failed because the I/O group is used for recovery.

Action

Not applicable.

CMMVC5793E The node was not added to the cluster because the I/O group already contains a pair of nodes.

Explanation

The node was not added to the cluster because the I/O group already contains a pair of nodes.

Action

Not applicable.

CMMVC5794E The action failed because the node is not a member of the cluster.

Explanation

The node is not a member of the cluster, therefore the action failed.

Action

Specify a node that is contained in the cluster and reissue the command.

CMMVC5795E The node was not deleted because a software upgrade is in progress.

Explanation

The node was not deleted because a software upgrade is in progress.

Action

Wait for the software upgrade to complete and then reissue the command.

CMMVC5796E The action failed because the I/O group that the node belongs to is unstable.

Explanation

A previous configuration command might not yet have completed.

Action

Wait for the previous command to complete and then reissue the command.

CMMVC5797E The node was not deleted because this is the last node in the I/O group and there are virtual disks (VDisks) associated with the I/O group.

Explanation

The specified node is the last node in the I/O group and there are VDisks associated with the I/O group, therefore the node could not be deleted.

Action

Not applicable.

CMMVC5798E The action failed because the node is offline.

Explanation

The action failed because the node is offline.

Action

Specify a node that is online and reissue the command.

CMMVC5799E The shut down was not successful because there is only one online node in the I/O group.

Explanation

There is only one online node in the I/O group, therefore the shut down operation was not successful.

Action

Not applicable.

CMMVC5800E The action failed because an entity that was specified in the command does not exist.

Explanation

The entity that was specified in the command does not exist, therefore the action failed.

Action

Specify a different entity and reissue the command.

CMMVC5801E The upgrade of the cluster software could not proceed because every node in the cluster must be online. Either delete the node that is offline or bring the node online and resubmit the command

Explanation

The upgrade of the cluster software could not proceed because every node in the cluster must be online.

Action

Either delete the node that is offline or bring the node online and reissue the command.

CMMVC5802E The upgrade of the cluster software could not proceed because there is an I/O group in the cluster that contains only one node. The software upgrade requires that each node in an I/O group be shut down and restarted. If there is only one node in an I/O group, I/O operations could be lost if I/O operations are not stopped before beginning the software upgrade.

Explanation

The upgrade of the cluster software could not proceed because there is an I/O group in the cluster that contains only one node. The software upgrade requires that each node in an I/O group be shut down and restarted. If there is only one node in an I/O group, I/O operations could be lost if I/O operations are not stopped before beginning the software upgrade.

Action

Either upgrade the cluster using the -force option or specify a different node and reissue the command.

CMMVC5803E The entry in the error log was not marked because the sequence number was not found.

Explanation

The entry in the error log was not marked because the sequence number was not found.

Action

Not applicable.

CMMVC5804E The action failed because an entity that was specified in the command does not exist.

Explanation

The entity that was specified in the command does not exist, therefore the action failed.

Action

Specify a different entity and reissue the command.

CMMVC5805E The progress information was not returned because the FlashCopy statistics are not ready yet.

Explanation

The progress information was not returned because the FlashCopy statistics are not ready yet.

Action

Not applicable.

CMMVC5806E The action failed because an entity that was specified in the command does not exist.

Explanation

The entity that was specified in the command does not exist, therefore the action failed.

Action

Specify a different entity and reissue the command.

CMMVC5807E The action failed because the managed disk (MDisk) cannot be changed to the specified mode.

Explanation

The action failed because the managed disk (MDisk) cannot be changed to the specified mode.

Action

Not applicable.

CMMVC5808E The action failed because the managed disk (MDisk) does not exist.

Explanation

The action failed because the managed disk (MDisk) does not exist.

Action

Specify a different MDisk and reissue the command.

CMMVC5809E The tracing of I/O operations was not started because it is already in progress.

Explanation

The tracing of I/O operations was not started because it is already in progress.

Action

Not applicable.

CMMVC5810E The quorum index number for the managed disk (MDisk) was not set because the MDisk is offline.

Explanation

The quorum index number for the managed disk (MDisk) was not set because the MDisk is offline.

Action

Either change the status of the MDisk to online or specify a different MDisk and reissue the command.

CMMVC5811E The quorum index number for the managed disk (MDisk) was not set because the quorum disk does not exist.

Explanation

The quorum index number for the managed disk (MDisk) was not set because the quorum disk does not exist.

Action

Specify a different quorum disk and reissue the command.

CMMVC5812E The quorum index number for the managed disk (MDisk) was not set because the MDisk is in the wrong mode. Select an MDisk that has a mode of managed.

Explanation

The quorum index number for the managed disk (MDisk) was not set because the MDisk is not in the managed mode.

Action

- Change the mode of the MDisk and reissue the command
 - Select an MDisk with a mode of managed and reissue the command
-

CMMVC5813E The quorum index number for the managed disk (MDisk) was not set because the MDisk has a sector size that is not valid.

Explanation

The parameter list that was specified is not valid.

Action

Specify a different sector size for the MDisk and reissue the command.

CMMVC5814E The quorum index number for the managed disk (MDisk) was not set because the unique identifier (UID) type is not valid.

Explanation

The quorum index number for the managed disk (MDisk) was not set because the unique identifier (UID) type is not valid.

Action

Specify a different unique identifier (UID) and reissue the command.

CMMVC5815E The managed disk (MDisk) group was not created because an entity that was specified in the command does not exist.

Explanation

The managed disk (MDisk) group was not created because an entity that was specified in the command does not exist.

Action

Specify a different entity and reissue the command.

CMMVC5816E The action failed because an entity that was specified in the command does not exist.

Explanation

The action failed because an entity that was specified in the command does not exist.

Action

Specify a different entity and reissue the command.

CMMVC5817E The managed disk (MDisk) group was not renamed because the name was not valid.

Explanation

The managed disk (MDisk) group was not renamed because the name was not valid.

Action

Specify a different MDisk group name and reissue the command.

CMMVC5818E The managed disk (MDisk) group was not deleted because there is at least one MDisk in the group.

Explanation

The managed disk (MDisk) group was not deleted because there is at least one MDisk in the group.

Action

Not applicable.

CMMVC5819E The managed disk (MDisk) was not added to the MDisk group because the MDisk is part of another MDisk group.

Explanation

The managed disk (MDisk) was not added to the MDisk group because the MDisk is part of another MDisk group.

Action

Not applicable.

CMMVC5820E The managed disk (MDisk) was not added to the MDisk group because an entity that was specified in the command does not exist.

Explanation

The managed disk (MDisk) was not added to the MDisk group because an entity that was specified in the command does not exist.

Action

Specify a different entity and reissue the command.

CMMVC5821E The managed disk (MDisk) was not added to the MDisk group because not enough MDisks were included in the list.

Explanation

The managed disk (MDisk) was not added to the MDisk group because not enough MDisks were included in the list.

Action

Include more MDisks in the list and reissue the command.

CMMVC5822E The managed disk (MDisk) was not added to the MDisk group because too many MDisks were included in the list.

Explanation

The managed disk (MDisk) was not added to the MDisk group because too many MDisks were included in the list.

Action

Delete the extra MDisks in the list and reissue the command.

CMMVC5823E The managed disk (MDisk) was not deleted from the MDisk group because the MDisk is part of another MDisk group.

Explanation

The managed disk (MDisk) was not deleted from the MDisk group because the MDisk is part of another MDisk group.

Action

Not applicable.

CMMVC5824E The managed disk (MDisk) was not deleted from the MDisk group because it does not belong to the MDisk group.

Explanation

The managed disk (MDisk) was not deleted from the MDisk group because it does not belong to the MDisk group.

Action

Not applicable.

CMMVC5825E The managed disk (MDisk) was not deleted from the MDisk group because a virtual disk (VDisk) is allocated from one or more of the specified MDisks. A forced deletion is required.

Explanation

The managed disk (MDisk) was not deleted from the MDisk group because a virtual disk (VDisk) is allocated from one or more of the specified MDisks.

Action

Specify the `-force` option and reissue the command.

CMMVC5826E The virtual disk (VDisk) was not created because an entity that was specified in the command does not exist.

Explanation

The virtual disk (VDisk) was not created because an entity that was specified in the command does not exist.

Action

Specify a different entity and reissue the command.

CMMVC5827E The command failed as a result of an inconsistency between two or more of the entered parameters.

Explanation

The command failed as a result of an inconsistency between two or more of the entered parameters.

Action

Specify one parameter and reissue the command.

CMMVC5828E The virtual disk (VDisk) was not created because the I/O group contains no nodes.

Explanation

The virtual disk (VDisk) was not created because the I/O group contains no nodes.

Action

Not applicable.

CMMVC5829E The image-mode or sequential-mode virtual disk (VDisk) was not created because more than one managed disk (MDisk) is specified.

Explanation

The image-mode or sequential-mode VDisk was not created because more than one MDisk is specified.

Action

Specify a different MDisk and reissue the command.

CMMVC5830E The image-mode virtual disk (VDisk) was not created because no managed disk (MDisk) was specified in the command.

Explanation

The image-mode virtual disk (VDisk) was not created because no managed disk (MDisk) was specified in the command.

Action

Specify a MDisk and reissue the command.

CMMVC5831E The virtual disk (VDisk) was not created because the preferred node for I/O operations is not part of the I/O group.

Explanation

The virtual disk (VDisk) was not created because the preferred node for I/O operations is not part of the I/O group.

Action

Specify a different node and reissue the command.

CMMVC5832E The property of the virtual disk (VDisk) was not modified because an entity that was specified in the command does not exist.

Explanation

The property of the virtual disk (VDisk) was not modified because an entity that was specified in the command does not exist.

Action

Specify a different entity and reissue the command.

CMMVC5833E The property of the virtual disk (VDisk) was not modified because there are no nodes in the I/O group.

Explanation

The property of the virtual disk (VDisk) was not modified because there are no nodes in the I/O group.

Action

Not applicable.

CMMVC5834E The I/O group for the virtual disk (VDisk) was not modified because the group is a recovery I/O group. To modify the I/O group, use the force option.

Explanation

The I/O group for the virtual disk (VDisk) was not modified because the group is a recovery I/O group.

Action

Specify the -force option and reissue the command.

CMMVC5835E The virtual disk (VDisk) was not expanded because an entity that was specified in the command does not exist.

Explanation

The virtual disk (VDisk) was not expanded because an entity that was specified in the command does not exist.

Action

Specify a different entity and reissue the command.

CMMVC5836E The virtual disk (VDisk) was not shrunk because it is locked.

Explanation

Commands might still be running in the background.

Action

Wait for all commands to complete. Use the `svcinfo lsmigrate` command to view any migrates running in the background.

CMMVC5837E The action failed because the virtual disk (VDisk) is part of a FlashCopy mapping.

Explanation

The action failed because the virtual disk (VDisk) is part of a FlashCopy mapping.

Action

Specify a different VDisk that is not part of a FlashCopy mapping and reissue the command.

CMMVC5838E The action failed because the virtual disk (VDisk) is part of a Metro Mirror mapping.

Explanation

The action failed because the virtual disk (VDisk) is part of a Metro Mirror mapping.

Action

Specify a different VDisk that is not part of a Metro Mirror mapping and reissue the command.

CMMVC5839E The virtual disk (VDisk) was not shrunk because an entity that was specified in the command does not exist.

Explanation

The virtual disk (VDisk) was not shrunk because an entity that was specified in the command does not exist.

Action

Specify a different entity and reissue the command.

CMMVC5840E The virtual disk (VDisk) was not deleted because it is mapped to a host or because it is part of a FlashCopy or Metro Mirror mapping.

Explanation

The virtual disk (VDisk) was not deleted because it is mapped to a host or because it is part of a FlashCopy or Metro Mirror mapping.

Action

Specify a different VDisk and reissue the command.

CMMVC5841E The virtual disk (VDisk) was not deleted because it does not exist.

Explanation

The virtual disk (VDisk) was not deleted because it does not exist.

Action

Specify a different VDisk and reissue the command.

CMMVC5842E The action failed because an entity that was specified in the command does not exist.

Explanation

The action failed because an entity that was specified in the command does not exist.

Action

Specify a different entity and reissue the command.

CMMVC5843E The virtual disk (VDisk)-to-host mapping was not created because the VDisk does not have a capacity greater than zero bytes.

Explanation

The virtual disk (VDisk)-to-host mapping was not created because the VDisk does not have a capacity greater than zero bytes.

Action

Specify a VDisk in which its capacity is greater than zero bytes and reissue the command.

CMMVC5844E The virtual disk (VDisk)-to-host mapping was not created because the SCSI logical unit number (LUN) ID is not valid.

Explanation

The virtual disk (VDisk)-to-host mapping was not created because the SCSI logical unit number (LUN) ID is not valid.

Action

Specify the correct SCSI logical unit number (LUN) ID and reissue the command.

CMMVC5845E The extent was not migrated because an entity that was specified in the command does not exist.

Explanation

The extent was not migrated because an entity that was specified in the command does not exist.

Action

Specify a different entity and reissue the command.

CMMVC5846E The virtual disk (VDisk) was not migrated because an entity that was specified in the command does not exist.

Explanation

The virtual disk (VDisk) was not migrated because an entity that was specified in the command does not exist.

Action

Specify a different entity and reissue the command.

CMMVC5847E The virtual disk (VDisk) was not migrated because its associated managed disk (MDisk) is already in the MDisk group.

Explanation

The virtual disk (VDisk) was not migrated because its associated managed disk (MDisk) is already in the MDisk group.

Action

Not applicable.

CMMVC5848E The action failed because the virtual disk (VDisk) does not exist or it is being deleted.

Explanation

The action failed because the virtual disk (VDisk) does not exist or it is being deleted.

Action

Specify a different VDisk and reissue the command.

CMMVC5849E The migration failed because some or all of the extents are already being migrated.

Explanation

The migration failed because some or all of the extents are already being migrated.

Action

Not applicable.

CMMVC5850E The extent was not migrated because there is a problem with the source extents.

Explanation

The extent was not migrated because there is a problem with the source extents.

Action

Not applicable.

CMMVC5851E The extent was not migrated because there is a problem with the target extents.

Explanation

The extent was not migrated because there is a problem with the target extents.

Action

Not applicable.

CMMVC5852E The migration failed because there are too many migrations in progress.

Explanation

The migration failed because there are too many migrations in progress.

Action

Wait for the migration process to complete and reissue the command.

CMMVC5853E The action failed because there was a problem with the MDisk group.

Explanation

An attempt was made to work on a VDisk which is using an MDisk group with one of the following problems:

- The target and source MDisk groups have different extent sizes (group migrate).
- The target and source MDisk groups are the same (group migrate).
- The target and source MDisk groups are different (extents migrate).
- Target invalid group (Group Migrate).
- Source invalid group (Group Migrate).

Action

Ensure that none of the above conditions exist before reissuing the command.

CMMVC5854E The extent information was not returned because the extent is not used or does not exist.

Explanation

The extent information was not returned because the extent is not used or does not exist.

Action

Specify the correct extent and reissue the command.

CMMVC5855E The extent information was not returned because the managed disk (MDisk) is not used by any virtual disk (VDisk).

Explanation

The extent information was not returned because the managed disk (MDisk) is not used by any virtual disk (VDisk).

Action

Specify the correct MDisk and reissue the command.

CMMVC5856E The action failed because the virtual disk (VDisk) does not belong to the specified managed disk (MDisk) group.

Explanation

The action failed because the virtual disk (VDisk) does not belong to the specified managed disk (MDisk) group.

Action

Specify a different VDisk and reissue the command.

CMMVC5857E The action failed because the managed disk (MDisk) does not exist or it is not a member of the managed disk (MDisk) group.

Explanation

The action failed because the managed disk (MDisk) does not exist or it is not a member of the managed disk (MDisk) group.

Action

Specify a different MDisk and reissue the command.

CMMVC5858E The action failed because the virtual disk (VDisk) is in the wrong mode, the managed disk (MDisk) is in the wrong mode, or both are in the wrong mode.

Explanation

The action failed because the virtual disk (VDisk) is in the wrong mode, the managed disk (MDisk) is in the wrong mode, or both are in the wrong mode.

Action

Check that the VDisk and MDisk are in the correct mode and reissue the command.

CMMVC5859E The migration did not complete because an error occurred during the migration of the last extent on an image-mode virtual disk (VDisk).

Explanation

The migration did not complete because an error occurred during the migration of the last extent on an image-mode virtual disk (VDisk).

Action

Not applicable.

CMMVC5860E The action failed because there were not enough extents in the managed disk (MDisk) group.

Explanation

This error is also returned if a stripe set of MDisks has been specified and one or more of these MDisks does not contain enough free extents to complete the creation of the VDisk.

Action

In this case, the MDisk group reports that it has enough free capacity to create the VDisk. You can check the free capacity on each MDisk by issuing the `svcinfo lsfreeextents <mdiskname/ID>`. Alternatively, do not specify a stripe set and let the system choose the free extents automatically.

CMMVC5861E The action failed because there were not enough extents on the managed disk (MDisk).

Explanation

The action failed because there were not enough extents on the managed disk (MDisk).

Action

Specify another extent and reissue the command.

CMMVC5862E The action failed because the virtual disk (VDisk) is being formatted.

Explanation

The action failed because the virtual disk (VDisk) is being formatted.

Action

Wait for the VDisk to be successfully formatted and then reissue the command.

CMMVC5863E The migration failed because there are not enough free extents on the target managed disk (MDisk).

Explanation

The migration failed because there are not enough free extents on the target managed disk (MDisk).

Action

Specify another free extent and reissue the command.

CMMVC5864E The extent information was not returned because the source extent is not used.

Explanation

The extent information was not returned because the source extent is not used.

Action

Specify a different source extent and reissue the command.

CMMVC5865E The extent information was not returned because the extent is out of range for the managed disk (MDisk) or virtual disk (VDisk).

Explanation

The extent information was not returned because the extent is out of range for the managed disk (MDisk) or virtual disk (VDisk).

Action

Specify a different extent which is in range for the MDisk or VDisk and reissue the command.

CMMVC5866E The extent was not migrated because the extent contains internal data.

Explanation

The extent was not migrated because the extent contains internal data.

Action

Not applicable.

CMMVC5867E The action failed because the worldwide port name is already assigned or is not valid.

Explanation

The action failed because the worldwide port name is already assigned or is not valid.

Action

Specify a different worldwide port name and reissue the command.

CMMVC5868E The action failed because an entity that was specified in the command does not exist.

Explanation

The action failed because an entity that was specified in the command does not exist.

Action

Specify a different entity and reissue the command.

CMMVC5869E The host object was not renamed because the host ID or name is not valid.

Explanation

The host object was not renamed because the host ID or name is not valid.

Action

Specify a different host ID or name and reissue the command.

CMMVC5870E The host object was not deleted because an entity that was specified in the command does not exist.

Explanation

The host object was not deleted because an entity that was specified in the command does not exist.

Action

Specify the correct entity and reissue the command.

CMMVC5871E The action failed because one or more of the configured worldwide port names is in a mapping.

Explanation

The action failed because one or more of the configured worldwide port names is in a mapping.

Action

Specify a worldwide port name that is not in a mapping and reissue the command.

CMMVC5872E The worldwide port name (WWPN) was not added to the host object because an entity that was specified in the command does not exist.

Explanation

The port (WWPN) was not added to the host object because an entity that was specified in the command does not exist.

Action

Specify the correct entity and reissue the command.

CMMVC5873E The action failed because there is no matching worldwide port name (WWPN).

Explanation

The action failed because there is no matching worldwide port name.

Action

Not applicable.

CMMVC5874E The action failed because the host does not exist.

Explanation

The action failed because the host does not exist.

Action

Specify a different host and reissue the command.

CMMVC5875E The action failed because the virtual disk (VDisk) does not exist.

Explanation

The action failed because the virtual disk (VDisk) does not exist.

Action

Specify a different VDisk and reissue the command.

CMMVC5876E The virtual disk (VDisk)-to-host mapping was not created because the maximum number of mappings has been reached.

Explanation

The virtual disk (VDisk)-to-host mapping was not created because the maximum number of mappings has been reached.

Action

Not applicable.

CMMVC5877E The virtual disk (VDisk)-to-host mapping was not created because the maximum number of SCSI LUNs has been allocated.

Explanation

The virtual disk (VDisk)-to-host mapping was not created because the maximum number of SCSI LUNs has been allocated.

Action

Not applicable.

CMMVC5878E The virtual disk (VDisk)-to-host mapping was not created because this VDisk is already mapped to this host.

Explanation

The virtual disk (VDisk)-to-host mapping was not created because this VDisk is already mapped to this host.

Action

Specify a different VDisk and reissue the command.

CMMVC5879E The virtual disk-to-host mapping was not created because this SCSI LUN is already assigned to another mapping.

Explanation

The virtual disk-to-host mapping was not created because this SCSI LUN is already assigned to another mapping.

Action

Specify a different SCSI LUN and reissue the command.

CMMVC5880E The virtual disk (VDisk)-to-host mapping was not created because the VDisk has a capacity of zero bytes.

Explanation

The virtual disk (VDisk)-to-host mapping was not created because the VDisk has a capacity of zero bytes.

Action

Specify a different VDisk and reissue the command.

CMMVC5881E The FlashCopy mapping was not created because an entity that was specified in the command does not exist.

Explanation

The FlashCopy mapping was not created because an entity that was specified in the command does not exist.

Action

Specify a different entity and reissue the command.

CMMVC5882E The FlashCopy mapping was not created because a mapping for the source or target virtual disk (VDisk) already exists.

Explanation

The FlashCopy mapping was not created because a mapping for the source or target virtual disk (VDisk) already exists.

Action

Specify a different source or target VDisk and reissue the command.

CMMVC5883E The FlashCopy mapping was not created because the recovery I/O group is associated with the source or target virtual disk (VDisk).

Explanation

The FlashCopy mapping was not created because the recovery I/O group is associated with the source or target virtual disk (VDisk).

Action

Specify a different recovery I/O group and reissue the command.

CMMVC5884E The FlashCopy mapping was not created because the source or target virtual disk (VDisk) cannot be a member of a Metro Mirror mapping.

Explanation

The FlashCopy mapping was not created because the source or target virtual disk (VDisk) cannot be a member of a Metro Mirror mapping.

Action

Specify a different source or target VDisk and reissue the command.

CMMVC5885E The FlashCopy mapping was not created because this source or target virtual disk (VDisk) cannot be a member of a FlashCopy mapping.

Explanation

The FlashCopy mapping was not created because this source or target virtual disk (VDisk) cannot be a member of a FlashCopy mapping.

Action

Specify a different source or target VDisk and reissue the command.

CMMVC5886E The FlashCopy mapping was not created because the source or target virtual disk (VDisk) is associated with the recovery I/O group.

Explanation

The FlashCopy mapping was not created because the source or target virtual disk (VDisk) is associated with the recovery I/O group.

Action

Specify a different source or target VDisk and reissue the command.

CMMVC5887E The FlashCopy mapping was not created because the source or target virtual disk (VDisk) must not be in router mode.

Explanation

The FlashCopy mapping was not created because the source or target virtual disk (VDisk) must not be in router mode.

Action

Specify a different source or target VDisk and reissue the command.

CMMVC5888E The action failed because an entity that was specified in the command does not exist.

Explanation

The action failed because an entity that was specified in the command does not exist.

Action

Specify the correct entity and reissue the command.

CMMVC5889E The FlashCopy mapping was not deleted because an entity that was specified in the command does not exist.

Explanation

The FlashCopy mapping was not deleted because an entity that was specified in the command does not exist.

Action

Specify a different entity and reissue the command.

CMMVC5890E The FlashCopy mapping or consistency group was not started because starting consistency group 0 is not a valid operation.

Explanation

The FlashCopy mapping or consistency group was not started because starting consistency group 0 is not a valid operation.

Action

Not applicable.

CMMVC5891E The FlashCopy consistency group was not created because the name is not valid.

Explanation

The FlashCopy consistency group was not created because the name is not valid.

Action

Specify a different name and reissue the command.

CMMVC5892E The FlashCopy consistency group was not created because it already exists.

Explanation

The FlashCopy consistency group was not created because it already exists.

Action

Not applicable.

CMMVC5893E The action failed because an entity that was specified in the command does not exist.

Explanation

The action failed because an entity that was specified in the command does not exist.

Action

Specify the correct entity and reissue the command.

CMMVC5894E The FlashCopy consistency group was not deleted because you are trying to delete consistency group 0 or the name of the consistency group is not valid.

Explanation

The FlashCopy consistency group was not deleted because the name of the consistency group is not valid or you are trying to delete consistency group 0.

Action

Specify the correct consistency group and reissue the command.

CMMVC5895E The FlashCopy consistency group was not deleted because it contains mappings. To delete this consistency group, a forced deletion is required.

Explanation

The FlashCopy consistency group was not deleted because it contains mappings.

Action

Specify that -force option to delete the consistency group.

CMMVC5896E The FlashCopy mapping was not deleted because the mapping or consistency group is in the preparing state. The mapping or consistency group must be stopped first.

Explanation

The FlashCopy mapping was not deleted because the mapping or consistency group is in the preparing state. The mapping or consistency group must be stopped first.

Action

Stop the consistency group and then reissue the command.

CMMVC5897E The FlashCopy mapping was not deleted because the mapping or consistency group is in the prepared state. The mapping or consistency group must be stopped first.

Explanation

The FlashCopy mapping was not deleted because the mapping or consistency group is in the prepared state. The mapping or consistency group must be stopped first.

Action

Stop the consistency group and then reissue the command.

CMMVC5898E The FlashCopy mapping was not deleted because the mapping or consistency group is in the copying state. The mapping or consistency group must be stopped first.

Explanation

The FlashCopy mapping was not deleted because the mapping or consistency group is in the copying state. The mapping or consistency group must be stopped first.

Action

Stop the consistency group and then reissue the command.

CMMVC5899E The FlashCopy mapping was not deleted because the mapping or consistency group is in the stopped state. To delete the mapping, a forced deletion is required.

Explanation

The FlashCopy mapping was not deleted because the mapping or consistency group is in the stopped state.

Action

Specify the -force option to delete the mapping.

CMMVC5900E The FlashCopy mapping was not deleted because the mapping or consistency group is in the suspended state. The mapping or consistency group must be stopped first.

Explanation

The FlashCopy mapping was not deleted because the mapping or consistency group is in the suspended state. The mapping or consistency group must be stopped first.

Action

Stop the consistency group and the reissue the command.

CMMVC5901E The FlashCopy mapping was not prepared because the mapping or consistency group is already in the preparing state.

Explanation

The FlashCopy mapping was not prepared because the mapping or consistency group is already in the preparing state.

Action

Not applicable.

CMMVC5902E The FlashCopy mapping was not prepared because the mapping or consistency group is already in the prepared state.

Explanation

The FlashCopy mapping was not prepared because the mapping or consistency group is already in the prepared state.

Action

Not applicable.

CMMVC5903E The FlashCopy mapping was not prepared because the mapping or consistency group is already in the copying state.

Explanation

The FlashCopy mapping was not prepared because the mapping or consistency group is already in the copying state.

Action

Not applicable.

CMMVC5904E The FlashCopy mapping was not prepared because the mapping or consistency group is already in the suspended state.

Explanation

The FlashCopy mapping was not prepared because the mapping or consistency group is already in the suspended state.

Action

Not applicable.

CMMVC5905E The FlashCopy mapping or consistency group was not started because the mapping or consistency group is in the idle state. The mapping or consistency group must be prepared first.

Explanation

The FlashCopy mapping or consistency group was not started because the mapping or consistency group is in the idle state.

Action

Prepare the mapping or consistency group and then reissue the command.

CMMVC5906E The FlashCopy mapping or consistency group was not started because the mapping or consistency group is in the preparing state.

Explanation

The FlashCopy mapping or consistency group was not started because the mapping or consistency group is in the preparing state.

Action

Not applicable.

CMMVC5907E The FlashCopy mapping or consistency group was not started because the mapping or consistency group is already in the copying state.

Explanation

The FlashCopy mapping or consistency group was not started because the mapping or consistency group is already in the copying state.

Action

Not applicable.

CMMVC5908E The FlashCopy mapping or consistency group was not started because the mapping or consistency group is in the stopped state. The mapping or consistency group must be prepared first.

Explanation

The FlashCopy mapping or consistency group was not started because the mapping or consistency group is in the stopped state.

Action

Prepare the mapping or consistency group and reissue the command.

CMMVC5909E The FlashCopy mapping or consistency group was not started because the mapping or consistency group is in the suspended state.

Explanation

The FlashCopy mapping or consistency group was not started because the mapping or consistency group is in the suspended state.

Action

Not applicable.

CMMVC5910E The FlashCopy mapping or consistency group was not stopped because the mapping or consistency group is in the idle state.

Explanation

The FlashCopy mapping or consistency group was not stopped because the mapping or consistency group is in the idle state.

Action

Not applicable.

CMMVC5911E The FlashCopy mapping or consistency group was not stopped because the mapping or consistency group is in the preparing state.

Explanation

The FlashCopy mapping or consistency group was not stopped because the mapping or consistency group is in the preparing state.

Action

Not applicable.

CMMVC5912E The FlashCopy mapping or consistency group was not stopped because the mapping or consistency group is already in the stopped state.

Explanation

The FlashCopy mapping or consistency group was not stopped because the mapping or consistency group is already in the stopped state.

Action

Not applicable.

CMMVC5913E The properties of the FlashCopy mapping were not modified because the mapping or consistency group is in the preparing state.

Explanation

The properties of the FlashCopy mapping were not modified because the mapping or consistency group is in the preparing state.

Action

Not applicable.

CMMVC5914E The properties of the FlashCopy mapping were not modified because the mapping or consistency group is in the prepared state.

Explanation

The properties of the FlashCopy mapping were not modified because the mapping or consistency group is in the prepared state.

Action

Not applicable.

CMMVC5915E The properties of the FlashCopy mapping were not modified because the mapping or consistency group is in the copying state.

Explanation

The properties of the FlashCopy mapping were not modified because the mapping or consistency group is in the copying state.

Action

Not applicable.

CMMVC5916E The properties of the FlashCopy mapping were not modified because the mapping or consistency group is in the suspended state.

Explanation

The properties of the FlashCopy mapping were not modified because the mapping or consistency group is in the suspended state.

Action

Not applicable.

CMMVC5917E The FlashCopy mapping was not created because there is no memory to create the bitmap.

Explanation

The FlashCopy mapping was not created because there is no memory to create the bitmap.

Action

Not applicable.

CMMVC5918E The FlashCopy mapping was not prepared because the I/O group is offline.

Explanation

The FlashCopy mapping was not prepared because the I/O group is offline.

Action

Not applicable.

CMMVC5919E The FlashCopy mapping or consistency group was not started because the I/O group is offline.

Explanation

The FlashCopy mapping or consistency group was not started because the I/O group is offline.

Action

Not applicable.

CMMVC5920E The FlashCopy mapping was not created because the consistency group is not idle.

Explanation

The FlashCopy mapping was not created because the consistency group is not idle.

Action

Not applicable.

CMMVC5921E The properties of the FlashCopy mapping were not modified because the consistency group is not idle.

Explanation

The properties of the FlashCopy mapping were not modified because the consistency group is not idle.

Action

Not applicable.

CMMVC5922E The FlashCopy mapping was not created because the destination virtual disk (VDisk) is too small.

Explanation

The FlashCopy mapping was not created because the destination virtual disk (VDisk) is too small.

Action

Specify a different VDisk and reissue the command.

CMMVC5923E The FlashCopy mapping was not created because the I/O group is offline.

Explanation

The FlashCopy mapping was not created because the I/O group is offline.

Action

Not applicable.

CMMVC5924E The FlashCopy mapping was not created because the source and target virtual disks (VDisks) are different sizes.

Explanation

The FlashCopy mapping was not created because the source and target virtual disks (VDisks) are different sizes.

Action

Specify a different source and target VDisk that are the same size and reissue the command.

CMMVC5925E The remote cluster partnership was not created because it already exists.

Explanation

The remote cluster partnership was not created because it already exists.

Action

Specify a different remote cluster partnership and reissue the command.

CMMVC5926E The remote cluster partnership was not created because there are too many partnerships.

Explanation

The remote cluster partnership was not created because there are too many partnerships.

Action

Not applicable.

CMMVC5927E The action failed because the cluster ID is not valid.

Explanation

The action failed because the cluster ID is not valid.

Action

Specify the correct cluster ID and reissue the command.

CMMVC5928E The action failed because the cluster name is a duplicate of another cluster.

Explanation

The action failed because the cluster name is a duplicate of another cluster.

Action

Specify a different cluster name and reissue the command.

CMMVC5929E The Metro Mirror partnership was not deleted because it has already been deleted.

Explanation

The Metro Mirror partnership was not deleted because it has already been deleted.

Action

Not applicable.

CMMVC5930E The Metro Mirror relationship was not created because an entity that was specified in the command does not exist.

Explanation

The Metro Mirror relationship was not created because an entity that was specified in the command does not exist.

Action

Specify the correct entity and reissue the command.

CMMVC5931E The Metro Mirror relationship was not created because the master or auxiliary virtual disk (VDisk) is locked.

Explanation

The Metro Mirror relationship was not created because the master or auxiliary virtual disk (VDisk) is locked.

Action

Unlock the master or auxiliary VDisk and reissue the command.

CMMVC5932E The Metro Mirror relationship was not created because the master or auxiliary virtual disk (VDisk) is a member of a FlashCopy mapping.

Explanation

The Metro Mirror relationship was not created because the master or auxiliary virtual disk (VDisk) is a member of a FlashCopy mapping.

Action

Not applicable.

CMMVC5933E The Metro Mirror relationship was not created because the master or auxiliary virtual disk (VDisk) is in the recovery I/O group.

Explanation

The Metro Mirror relationship was not created because the master or auxiliary virtual disk (VDisk) is in the recovery I/O group.

Action

Not applicable.

CMMVC5934E The Metro Mirror relationship was not created because the master or auxiliary virtual disk (VDisk) is in the router mode.

Explanation

The Metro Mirror relationship was not created because the master or auxiliary virtual disk (VDisk) is in the router mode.

Action

Not applicable.

CMMVC5935E The action failed because an entity that was specified in the command does not exist.

Explanation

The action failed because an entity that was specified in the command does not exist.

Action

Specify the correct entity and reissue the command.

CMMVC5936E The action failed because an entity that was specified in the command does not exist.

Explanation

The action failed because an entity that was specified in the command does not exist.

Action

Specify the correct entity and reissue the command.

CMMVC5937E The action failed because an entity that was specified in the command does not exist.

Explanation

The action failed because an entity that was specified in the command does not exist.

Action

Specify the correct entity and reissue the command.

CMMVC5938E The Metro Mirror consistency group was not deleted because the consistency group contains relationships. To delete the consistency group, the force option is required.

Explanation

The Metro Mirror consistency group was not deleted because the consistency group contains relationships.

Action

Specify the -force option to delete the consistency group.

CMMVC5939E The action failed because the cluster is not in a stable state.

Explanation

The action failed because the cluster is not in a stable state.

Action

Not applicable.

CMMVC5940E The cluster that contains the auxiliary virtual disk (VDisk) is unknown.

Explanation

The cluster that contains the auxiliary virtual disk (VDisk) is unknown.

Action

Not applicable.

CMMVC5941E The cluster that contains the master virtual disk (VDisk) has too many consistency groups.

Explanation

The cluster that contains the master virtual disk (VDisk) has too many consistency groups.

Action

Not applicable.

CMMVC5942E The cluster that contains the auxiliary virtual disk (VDisk) has too many consistency groups.

Explanation

The cluster that contains the auxiliary virtual disk (VDisk) has too many consistency groups.

Action

Not applicable.

CMMVC5943E The specified relationship is not valid.

Explanation

The specified relationship is not valid.

Action

Specify the correct relationship and reissue the command.

CMMVC5944E The specified consistency group is not valid.**Explanation**

The specified consistency group is not valid.

Action

Specify the correct consistency group and reissue the command.

CMMVC5945E The specified master cluster is not valid.**Explanation**

The specified master cluster is not valid.

Action

Specify the correct master cluster and reissue the command.

CMMVC5946E The specified auxiliary cluster is not valid.**Explanation**

The specified auxiliary cluster is not valid.

Action

Specify the correct auxiliary cluster and reissue the command.

CMMVC5947E The specified master virtual disk (VDisk) is not valid.**Explanation**

The specified master virtual disk (VDisk) is not valid.

Action

Specify the correct master VDisk and reissue the command.

CMMVC5948E The specified auxiliary virtual disk (VDisk) is not valid.**Explanation**

The specified auxiliary virtual disk (VDisk) is not valid.

Action

Specify the auxiliary VDisk and reissue the command.

CMMVC5949E The specified relationship is unknown.**Explanation**

The specified relationship is unknown.

Action

Specify a different relationship and reissue the command.

CMMVC5950E The specified consistency group is unknown.**Explanation**

The specified consistency group is unknown.

Action

Specify a different consistency group and reissue the command.

CMMVC5951E The operation cannot be performed because the relationship is not a stand-alone one.**Explanation**

The operation cannot be performed because the relationship is not a stand-alone one.

Action

Not applicable.

CMMVC5952E The relationship and consistency group have different master clusters.**Explanation**

The relationship and consistency group have different master clusters.

Action

Not applicable.

CMMVC5953E The relationship and group have different auxiliary clusters.**Explanation**

The relationship and group have different auxiliary clusters.

Action

Not applicable.

CMMVC5954E The master and auxiliary virtual disks (VDisks) are different sizes.

Explanation

The master and auxiliary virtual disks (VDisks) are different sizes

Action

Not applicable.

CMMVC5955E The maximum number of relationships has been reached.

Explanation

The maximum number of relationships has been reached.

Action

Not applicable.

CMMVC5956E The maximum number of consistency groups has been reached.

Explanation

The maximum number of consistency groups has been reached.

Action

Not applicable.

CMMVC5957E The master virtual disk (VDisk) is already in a relationship.

Explanation

The master virtual disk (VDisk) is already in a relationship.

Action

Specify a different master VDisk and reissue the command.

CMMVC5958E The auxiliary virtual disk (VDisk) is already in a relationship.

Explanation

The auxiliary virtual disk (VDisk) is already in a relationship.

Action

Specify a different auxiliary VDisk and reissue the command.

CMMVC5959E There is a relationship that already has this name on the master cluster.

Explanation

There is a relationship that already has this name on the master cluster.

Action

Specify a different name and reissue the command.

CMMVC5960E There is a relationship that already has this name on the auxiliary cluster.

Explanation

There is a relationship that already has this name on the auxiliary cluster.

Action

Specify a different name and reissue the command.

CMMVC5961E There is a consistency group that already has this name on the master cluster.

Explanation

There is a consistency group that already has this name on the master cluster.

Action

Specify a different name and reissue the command.

CMMVC5962E There is a consistency group that already has this name on the auxiliary cluster.

Explanation

There is a consistency group that already has this name on the auxiliary cluster.

Action

Specify a different name and reissue the command.

CMMVC5963E No direction has been defined.

Explanation

No direction has been defined.

Action

Not applicable.

CMMVC5964E The copy priority is not valid.**Explanation**

The copy priority is not valid.

Action

Not applicable.

CMMVC5965E The virtual disks (VDisks) are in different I/O groups on the local cluster.**Explanation**

The virtual disks (VDisks) are in different I/O groups on the local cluster.

Action

Not applicable.

CMMVC5966E The master virtual disk (VDisk) is unknown.**Explanation**

The master virtual disk (VDisk) is unknown.

Action

Specify a different master VDisk and reissue the command.

CMMVC5967E The auxiliary virtual disk (VDisk) is unknown.**Explanation**

The auxiliary virtual disk (VDisk) is unknown.

Action

Specify a different auxiliary VDisk and reissue the command.

CMMVC5968E The relationship cannot be added because the states of the relationship and the consistency group do not match.**Explanation**

The relationship cannot be added because the states of the relationship and the consistency group do not match.

Action

Not applicable.

CMMVC5969E The Metro Mirror relationship was not created because the I/O group is offline.

Explanation

The Metro Mirror relationship was not created because the I/O group is offline.

Action

Not applicable.

CMMVC5970E The Metro Mirror relationship was not created because there is not enough memory.

Explanation

The Metro Mirror relationship was not created because there is not enough memory.

Action

Not applicable.

CMMVC5971E The operation was not performed because the consistency group contains no relationships.

Explanation

The operation was not performed because the consistency group contains no relationships.

Action

Not applicable.

CMMVC5972E The operation was not performed because the consistency group contains relationships.

Explanation

The operation was not performed because the consistency group contains relationships.

Action

Not applicable.

CMMVC5973E The operation was not performed because the consistency group is not synchronized.

Explanation

The operation was not performed because the consistency group is not synchronized.

Action

Specify the Force option when starting the consistency group.

CMMVC5974E The operation was not performed because the consistency group is offline.

Explanation

The operation was not performed because the consistency group is offline.

Action

Not applicable.

CMMVC5975E The operation was not performed because the cluster partnership is not connected.

Explanation

The operation was not performed because the cluster partnership is not connected.

Action

Not applicable.

CMMVC5976E The operation was not performed because the consistency group is in the freezing state.

Explanation

The operation was not performed because the consistency group is in the freezing state.

Action

Not applicable.

CMMVC5977E The operation was not performed because it is not valid given the current consistency group state.

Explanation

The operation was not performed because it is not valid given the current consistency group state.

Action

Not applicable.

CMMVC5978E The operation was not performed because the relationship is not synchronized.

Explanation

The operation was not performed because the relationship is not synchronized.

Action

Not applicable.

CMMVC5980E The operation was not performed because the master and auxiliary clusters are not connected.

Explanation

The operation was not performed because the master and auxiliary clusters are not connected.

Action

Not applicable.

CMMVC5981E The operation was not performed because the relationship is in the freezing state.

Explanation

The operation was not performed because the relationship is in the freezing state.

Action

Not applicable.

CMMVC5982E The operation was not performed because it is not valid given the current relationship state.

Explanation

The operation was not performed because it is not valid given the current relationship state.

Action

Not applicable.

CMMVC5983E The dump file was not created. The file system might be full.

Explanation

The dump file was not created. The file system might be full.

Action

Not applicable.

CMMVC5984E The dump file was not written to disk. The file system might be full.

Explanation

The dump file was not written to disk. The file system might be full.

Action

Not applicable.

CMMVC5985E The action failed because the directory that was specified was not one of the following directories: /dumps, /dumps/iostats, /dumps/iotrace, /dumps/feature, /dumps/configs, /dumps/elogs, or /home/admin/upgrade.

Explanation

The action failed because the directory that was specified was not one of the following directories:

- /dumps
- /dumps/iostats
- /dumps/iotrace
- /dumps/feature
- /dumps/configs
- /dumps/elogs
- /home/admin/upgrade

Action

Specify one of the above directories and reissue the command.

CMMVC5986E The tracing of I/O operations was not started because the virtual disk (VDisk) or managed disk (MDisk) failed to return statistics.

Explanation

The tracing of I/O operations was not started because the virtual disk (VDisk) or managed disk (MDisk) failed to return statistics.

Action

Not applicable.

CMMVC5987E Address is not valid.**Explanation**

Address is not valid.

Action

Specify a different address and reissue the command.

CMMVC5988E This command should not be issued if you are logged in with a root user ID. Use the admin userid.**Explanation**

This command should not be issued if you are logged in with a root user ID. Use the admin userid.

Action

Log off of the root user ID and log in as admin.

CMMVC5989E The operation was not performed because the relationship is offline.**Explanation**

The operation was not performed because the relationship is offline.

Action

Not applicable.

CMMVC5990E The FlashCopy consistency group was not stopped as there are no FlashCopy mappings within the group.**Explanation**

The FlashCopy consistency group was not stopped as there are no FlashCopy mappings within the group.

Action

Not applicable.

CMMVC5991E The FlashCopy consistency group was not stopped as there are no FlashCopy mappings within the group.

Explanation

The FlashCopy consistency group was not stopped as there are no FlashCopy mappings within the group.

Action

Not applicable.

CMMVC5992E The Metro Mirror consistency group was not stopped as there are no Metro Mirror relationships within the group.

Explanation

The Metro Mirror consistency group was not stopped as there are no Metro Mirror relationships within the group.

Action

Not applicable.

CMMVC5993E The specific upgrade package does not exist.

Explanation

The specific upgrade package does not exist.

Action

Not applicable.

CMMVC5994E Error in verifying the signature of the upgrade package.

Explanation

The system could not verify the signature of the upgrade package due to the following reasons:

- There is not enough space on the system to copy the file.
- The package is incomplete or contains errors.

Action

If the copy failed with an error indicating that there was insufficient space on the system, free up additional space on your system. Otherwise, ensure that the cluster time and date stamp on the signature is correct. (For example, the time and date cannot be in the future.)

CMMVC5995E An error when the system was unpacking the upgrade package.

Explanation

The most likely cause of this error is lack of system space.

Action

Reboot the node and unpack the upgrade package again.

CMMVC5996E The specific upgrade package cannot be installed over the current version.

Explanation

The upgrade package is not compatible with the current version or the system.

Action

Check the available upgrade packages and find the correct upgrade package for your current version and for your system. If the upgrade package is correct for your system, check the version requirements for the package. You might have to upgrade the current version to an intermediate version before you upgrade to the latest version. (For example, if your current version is 1 and you are trying to upgrade to version 3, you might need to upgrade to version 2 before applying the version 3 upgrade.)

CMMVC5997E The action failed because the capacity of the MDisk is smaller than the extent size of the MDisk group.

Explanation

The action failed because the capacity of the MDisk is smaller than the extent size of the MDisk group.

Action

- Select an MDisk that has a capacity equal to or larger than the extent size of the MDisk group.
 - Select a smaller extent size but one that is at least equal in size to the smallest MDisk in the MDisk group. (You can select a smaller extent size only if you are creating an MDisk group. After an MDisk is created, you cannot change the extent size.)
-

CMMVC5998W The virtualized storage capacity exceeds the amount that is licensed. Nevertheless, the requested action was completed.

Explanation

More virtualized storage capacity is being attempted beyond the scope of the license.

Action

Either reduce the amount of virtualized storage capacity currently in use, or license additional storage capacity.

CMMVC5999W Featurization for this facility has not been enabled.**Explanation**

Featurization for this facility has not been enabled.

Action

Not applicable.

CMMVC6000W Featurization for this facility has not been enabled.**Explanation**

Featurization for this facility has not been enabled.

Action

Not applicable.

CMMVC6001E The FlashCopy consistency group was not started as there are no FlashCopy mappings within the group.**Explanation**

The FlashCopy consistency group was not started as there are no FlashCopy mappings within the group.

Action

Create a FlashCopy within the appropriate group.

CMMVC6002E This command can only be run on a node that is in service mode.**Explanation**

This command can only be run on a node that is in service mode.

Action

Not applicable.

CMMVC6003E This command can not be run on a node that is in service mode.**Explanation**

This command can not be run on a node that is in service mode.

Action

Not applicable.

CMMVC6004E The delimiter value, %1, is invalid.**Explanation**

The delimiter value, %1, is invalid.

Action

Specify a different delimiter.

CMMVC6005E The view request failed as the specified object is not a member of an appropriate group.**Explanation**

A view was request on an object that has been incorrectly initialized.

Action

Ensure that the object is correctly initialized before resubmitting the view request.

CMMVC6006E The managed disk (MDisk) was not deleted because the resource was busy.**Explanation**

An attempt was made to delete an MDisk from a MDisk group that is being used as a source and destination for migration operations.

Action

Ensure that the MDisk group is not being used for migration operations before reissuing the command.

CMMVC6007E The two passwords that were entered do not match.**Explanation**

The two passwords entered for verification of your password change were not the same.

Action

Re-enter the passwords.

CMMVC6008E The key already exists.**Explanation**

An attempt was made to load a duplicate SSH key.

Action

Not applicable.

CMMVC6009E Unable to malloc a block of memory in which to copy the returned data.

Explanation

The command line was unable to allocate a block of memory in which to copy the results of the query.

Action

Free up some memory and reissue the command.

CMMVC6010E Unable to complete the command as there are insufficient free extents.

Explanation

There are not enough free extents to meet the request.

Action

Not applicable.

CMMVC6011E At least one remote cluster partnership has been found. This upgrade package cannot be applied to the current code level until all remote cluster partnerships are deleted.

Explanation

An attempt was made to apply software when a Metro Mirror relationship to a remote cluster exists.

Action

Delete the Metro Mirror relationship to the remote clusters and reissue the command.

CMMVC6012W The virtualized storage capacity is approaching the amount that is licensed.

Explanation

The requested action has completed. However, the limits permitted by the license you purchased are approaching.

Action

Subsequent actions might require that you increase your licensed limits.

CMMVC6013E The command failed because there is a consistency group mismatch on the aux cluster.

Explanation

The action has failed as there was a difference in attributes between the Metro Mirror consistency groups involved.

Action

Ensure that the attributes of the two Metro Mirror consistency groups match before resubmitting the command.

CMMVC6014E The command failed because the requested object is either unavailable or does not exist.

Explanation

The command failed because the requested object is either unavailable or does not exist.

Action

Ensure that all parameters have been correctly entered. If this is the case the determine why the object is unavailable, then reissue the command.

CMMVC6015E A delete request is already in progress for this object.

Explanation

A delete request is already in progress for this object.

Action

Not applicable.

CMMVC6016E The action failed as there would be, or are, no more disks in the MDisk group.

Explanation

The action failed as there would be, or are, no more disks in the I/O group.

Action

Ensure that all parameters have been correctly entered.

CMMVC6017E A parameter or argument contains invalid characters. Ensure that all characters are ASCII.

Explanation

The command-line interface (CLI) will only accept ASCII input.

Action

Ensure that all input to the CLI is ASCII, then resubmit the command.

CMMVC6018E The software upgrade pre-install process failed.

Explanation

The software upgrade failed as there was an error during the preprocessing. The package is either invalid or corrupted.

Action

Ensure the package is a valid upgrade package. Download the package from the source location again as it might have been corrupted during a network transfer.

CMMVC6019E The software upgrade failed as a node pended as the upgrade was in progress.

Explanation

The software upgrade failed as a node pended as the upgrade was in progress.

Action

Ensure that all nodes are online and available before restarting the upgrade process.

CMMVC6020E The software upgrade failed as the system was unable to distribute the software package to all nodes.

Explanation

The software upgrade failed as the system was unable to distribute the software package to all nodes.

Action

Ensure that all nodes are correctly zoned and that all nodes are online and can see the other nodes in the cluster. You might also want to check the error log.

CMMVC6021E The system is currently busy performing another request. Try again later.

Explanation

The requested action failed as the system is processing another request.

Action

Wait before resubmitting the request.

CMMVC6022E The system is currently busy performing another request. Please try again later.

Explanation

The requested action failed as the system is processing another request.

Action

Wait before resubmitting the request.

CMMVC6023E The system is currently busy performing another request. Please try again later.

Explanation

The requested action failed as the system is processing another request.

Action

Wait before resubmitting the request.

CMMVC6024E The auxiliary VDisk entered is invalid.

Explanation

The auxiliary VDisk is entered as a parameter in the command-line interface is not a valid auxiliary VDisk.

Action

Select a valid auxiliary VDisk and reissue the command.

CMMVC6025E The RC consistency group Master cluster is not the local cluster.

Explanation

The auxiliary VDisk is entered as a parameter in the command-line interface is not a valid auxiliary VDisk.

Action

Resubmit the command with a consistency group that belongs to the local cluster.

CMMVC6026E The Metro Mirror consistency group is not in the stopped state.

Explanation

The action failed as the Metro Mirror consistency group is not in the stopped state.

Action

Ensure that the Metro Mirror consistency group is in the stopped state before resubmitting the command.

CMMVC6027E The RC consistency group is not the primary master.

Explanation

The RC consistency group requested in the command is not the Metro Mirror primary master.

Action

Ensure that the parameters have been entered correctly on the command line.

CMMVC6028E This upgrade package cannot be applied to the current software level because it contains changes to the cluster state and there are remote cluster partnership defined.

Explanation

The action failed because there is a connected remote cluster. The upgrade cannot be applied because it would render the remote cluster at a different code level to the remote cluster.

Action

Ensure that the cluster partnership is deconfigured before resubmitting the command. Ensure that you deconfigure the remote cluster and upgrade the code on it before reconfiguring the cluster partnership.

CMMVC6029E All nodes must have identical code level before a concurrent code upgrade can be performed.

Explanation

The concurrent upgrade failed as two or more nodes were at differing code levels. All nodes must be at the same code level before a software upgrade can be performed.

Action

Use the service mode to bring all nodes to the same level before resubmitting the concurrent upgrade.

CMMVC6030E The operation was not preformed because the FlashCopy mapping is part of a consistency group. The action must be performed at the consistency group level.

Explanation

An attempt was made to stop a FlashCopy mapping. This failed as the FlashCopy mapping is part of a consistency group.

Action

Issue the stop command to the FlashCopy consistency group. This will stop all FlashCopies within that group that are in progress.

CMMVC6031E The operation was not performed because the FlashCopy consistency group is empty.

Explanation

An attempt was made to prestart an empty FlashCopy consistency group.

Action

Not applicable.

CMMVC6032E The operation was not performed because one or more of the entered parameters is invalid for this operation.

Explanation

An invalid parameter was entered for the command.

Action

If attempting to change the I/O group to which the VDisk belongs, ensure that the VDisk is not already a part of the group.

CMMVC6033E The action failed due to an internal error.

Explanation

An internal error caused the action to fail.

Action

Not applicable.

CMMVC6034E The action failed because the maximum number of objects has been reached.

Explanation

The action failed because the maximum number of objects has been reached.

Action

Not applicable.

CMMVC6035E The action failed as the object already exists.**Explanation**

An operation was requested to create an object that already exists.

Action

Ensure that the name you are attempting to apply to a new object does not exist, or change the name before re-issuing the command.

CMMVC6036E An invalid action was requested.**Explanation**

The action failed because it is not a valid action with the command that was issued.

Action

Issue an action that is valid with the command.

CMMVC6037E The action failed as the object is not empty.**Explanation**

The action failed because an object was specified.

Action

Reissue the command without specifying an object.

CMMVC6038E The action failed as the object is empty.**Explanation**

The action failed because an object was not specified.

Action

Specify an object, and reissue the command.

CMMVC6039E The action failed as the object is not a member of a group.**Explanation**

The action failed because the object is not a member of a group.

Action

Specify an object that is part of a group, and reissue the command.

CMMVC6040E The action failed as the object is not a parent.**Explanation**

The action failed because the object is not a parent object.

Action

Specify an object that is a parent, and reissue the command.

CMMVC6041E The action failed as the cluster is full.**Explanation**

The action failed because the cluster is full.

Action

Remove data from the cluster, and reissue the command.

CMMVC6042E The action failed as the object is not a cluster member.**Explanation**

The action failed because the object is not a member of the cluster.

Action

Specify an object that is a member of the cluster, and reissue the command.

CMMVC6043E The action failed as the object is a member of a group.**Explanation**

The action failed because the object is a member of a group.

Action

Specify an object that is not a member of a group, and reissue the command.

CMMVC6044E The action failed as the object is a parent.**Explanation**

The action failed because the object is a parent object.

Action

Specify an object that is not a parent object, and reissue the command.

CMMVC6045E The action failed, as the -force flag was not entered.

Explanation

The action failed because the -force option was not entered.

Action

Specify the -force option in the command.

CMMVC6046E The action failed as too many candidates were selected.

Explanation

The action failed because too many candidates were specified.

Action

Specify fewer candidates in the command.

CMMVC6047E The action failed as too few candidates were selected.

Explanation

An action was requested with too few candidate objects.

Action

Determine the correct number of candidates required for the specific command and re-issue the command.

CMMVC6048E The action failed as the object is busy.

Explanation

The action failed because the object is busy.

Action

Not applicable.

CMMVC6049E The action failed as the object is not ready.

Explanation

The action failed because the object is not ready.

Action

Not applicable.

CMMVC6050E The action failed as the command was busy.

Explanation

The action failed because the command is busy.

Action

Not applicable.

CMMVC6051E An unsupported action was selected.

Explanation

The action failed because it is not valid with the command.

Action

Specify an action that is valid with the command.

CMMVC6052E The action failed as the object is a member of a Flash Copy mapping.

Explanation

The object is a member of a FlashCopy mapping, thus it cannot be deleted.

Action

Specify an object that is not a member of a FlashCopy mapping, or remove the object from the FlashCopy mapping.

CMMVC6053E An invalid WWPN was entered.

Explanation

An invalid worldwide port name (WWPN) was specified.

Action

Specify a valid WWPN.

CMMVC6054E The action failed as not all nodes are online.

Explanation

One or more nodes are not online.

Action

Check that each node is online, and reissue the command.

CMMVC6055E The action failed as an upgrade is in progress.**Explanation**

The action failed because a software upgrade is in progress.

Action

Wait for the software upgrade to complete, and then reissue the command.

CMMVC6056E The action failed as the object is too small.**Explanation**

The action failed because the object is too small.

Action

Specify a different object, and reissue the command.

CMMVC6057E The action failed as the object is the target of a Flash Copy mapping.**Explanation**

The object is the target of a FlashCopy mapping, thus it cannot be deleted.

Action

Specify an object that is not the target of a FlashCopy mapping, or remove the object from the FlashCopy mapping.

CMMVC6058E The action failed as the object is in the recovery HWS.**Explanation**

An attempt was made to perform an operation on a node that is in the recovery IO group.

Action

Get the node into one of the other IO Groups and re-issue the command.

CMMVC6059E The action failed as the object is in an invalid mode.**Explanation**

The action failed because the object is in the wrong mode.

Action

Check that the object is in the correct mode, and reissue the command.

CMMVC6060E The action failed as the object is being deleted.**Explanation**

The action failed because the object is being deleted.

Action

Not applicable.

CMMVC6061E The action failed as the object is being resized.**Explanation**

The action failed because the object is being resized.

Action

Check that the object is in the correct mode, and reissue the command.

CMMVC6062E The action failed as the object is being moved between HWS.**Explanation**

An attempt was made to perform an action against an object that is currently being moved between IO groups.

Action

Re-issue the command when the move operation has completed.

CMMVC6063E The action failed as there are no more disks in the group.**Explanation**

An attempt was made to perform an action against a group that contained no disks.

Action

Either add disks to the group and re-issue the command, or select another group against which to execute the action.

CMMVC6064E The action failed as the object has an invalid name.**Explanation**

An attempt was made to create or rename an object using an invalid name.

Action

Use a name that meets the naming standards and re-issue the command.

CMMVC6065E The action failed as the object is not in a group.**Explanation**

An attempt was made to perform an action on an object that was not in an appropriate group.

Action

Ensure that the object is a member of an appropriate group and re-issue the command.

CMMVC6066E The action failed as the system is running low on memory.**Explanation**

The system is running low on memory.

Action

Not applicable.

CMMVC6067E The action failed as the SSH key was not found.**Explanation**

An attempt was made to perform an action using an SSH key that does not exist.

Action

Re-issue the command using a key that does exist.

CMMVC6068E The action failed as there are no free SSH keys.**Explanation**

An attempt was made to use an SSH key when there are no free SSH keys.

Action

Upload additional keys and re-issue the command.

CMMVC6069E The action failed as the SSH key is already registered.**Explanation**

An attempt was made to register an SSH key that was already registered.

Action

Not applicable.

CMMVC6070E An invalid or duplicated parameter, unaccompanied argument, or incorrect argument sequence has been detected. Ensure that the input is as per the help.

Explanation

The parameters entered for a command were invalid.

Action

Correct the parameters and re-issue the command.

CMMVC6071E The virtual disk is already mapped to a host. To create additional virtual disk-to-host mappings, you must use the command-line interface.

Explanation

The virtual disk is already mapped to a host.

Action

Use the command-line interface to create additional mappings.

CMMVC6073E The maximum number of files has been exceeded.

Explanation

The maximum number of files has been exceeded.

Action

Not applicable.

CMMVC6074E The command failed as the extent has already been assigned.

Explanation

The command failed as the extent has already been assigned.

Action

Assign a different extent and reissue the command.

CMMVC6075E The expand failed as the last extent is not a complete extent.

Explanation

The expand failed as the last extent is not a complete extent.

Action

Assign a different extent and reissue the command.

CMMVC6076E The command failed due to an error during the flushing of the VDisk.

Explanation

The command failed due to an error during the flushing of the VDisk.

Action

Not applicable.

CMMVC6077E WARNING - Unfixed errors should be fixed before applying software upgrade. Depending on the nature of the errors, they might cause the upgrade process to fail. It is highly recommended to fix these errors before proceeding. If a particular error cannot be fixed, contact the support center.

Explanation

Unfixed errors should be fixed before applying software upgrade. Depending on the nature of the errors, they might cause the upgrade process to fail. It is highly recommended to fix these errors before proceeding.

Action

If the error cannot be fixed, contact the support center.

CMMVC6078E The action failed because the object is in an invalid mode.

Explanation

An attempt was made to perform an action against an object in a mode that did not allow for that action to be performed.

Action

Get the object into a suitable mode and re-issue the command.

CMMVC6079E Metatdata recovery could not complete the operation because a parameter is invalid.

Explanation

Metatdata recovery could not complete the operation because a parameter is invalid.

CMMVC6081E Metadata Recovery is busy processing the previous operation.

Explanation

Metadata Recovery is busy processing the previous operation.

CMMVC6082E The attempt to abort metadata recovery failed because the previous operation has completed.

Explanation

The attempt to abort metadata recovery failed because the previous operation has completed.

Action

None.

CMMVC6083E Metadata recovery could not find a valid dumpfile required for the rebuild operation.

Explanation

Metadata recovery could not find a valid dumpfile required for the rebuild operation.

CMMVC6084E Metadata recovery could not create/open/write the scan file, the disk might be full.

Explanation

Metadata recovery could not create/open/write the scan file, the disk might be full.

CMMVC6085E Metadata recovery could not create/open/write the dump file, the disk might be full.

Explanation

Metadata recovery could not create/open/write the dump file, the disk might be full.

CMMVC6086E Metadata recovery could not create/open/write the progress file, the disk might be full.

Explanation

Metadata recovery could not create/open/write the progress file, the disk might be full.

CMMVC6087E Metadata recovery could not map the buffers necessary to complete the operation.

Explanation

Metadata recovery could not map the buffers necessary to complete the operation.

CMMVC6088E The lba at which metadata recovery was requested does not contain metadata.

Explanation

The lba at which metadata recovery was requested does not contain metadata.

CMMVC6089E The metadata at the requested lba is flagged as invalid.

Explanation

The metadata at the requested lba is flagged as invalid.

CMMVC6090E The metadata header checksum verification failed.

Explanation

The metadata header checksum verification failed.

CMMVC6091E The metadata region checksum verification failed.

Explanation

The metadata region checksum verification failed.

CMMVC6092E The metadata recovery operation was aborted.

Explanation

The metadata recovery operation was aborted.

CMMVC6093E Metadata recovery internal error - (read only)

Explanation

Metadata recovery internal error - (read only)

CMMVC6095E Metadata recovery encountered the end of the disk.

Explanation

Metadata recovery encountered the end of the disk.

CMMVC6096E Metadata recovery encountered an error from a lower layer - (v1 no resource).

Explanation

Metadata recovery encountered an error from a lower layer - (v1 no resource).

CMMVC6097E Metadata recovery encountered an error from a lower layer - (v1 failure).

Explanation

Metadata recovery encountered an error from a lower layer - (v1 failure).

CMMVC6098E The copy failed as the specified node is the configuration node.

Explanation

The copy failed because the specified node is the configuration node.

Action

Not applicable.

CMMVC6100E -option not consistent with action

Explanation

The specified option is not supported for this action.

Action

Remove the option and reissue the command.

CMMVC6101E -option not consistent with -option

Explanation

The two specified options cannot be used together.

Action

Remove one of the options and reissue the command.

CMMVC6102E -option and -option are alternatives

Explanation

The two specified options are alternatives and cannot be used together.

Action

Remove one of the options and reissue the command.

CMMVC6103E Problem with file-name: details**Explanation**

A problem occurred when opening a file. Determine the cause of the problem and correct it before trying again.

Action

Correct the problem and then reissue the command.

CMMVC6104E Action name not run**Explanation**

An unexpected error occurred.

Action

Contact the support center.

CMMVC6105E Different names for source (name) and target (name) clusters**Explanation**

The backup configuration cannot be restored to the target cluster because the source and target cluster have different names.

Action

Perform one of the following actions: (1) Use a different backup configuration. (2) Delete the cluster and recreate it with the same name as that stored in the backup configuration file.

CMMVC6106W Target cluster has non-default id_alias alias**Explanation**

The id_alias of the target cluster has a non-default target. Clusters should have a default value. The non-default value suggests the cluster is customized and is not suitable for restoration. Restoration changes the id_alias.

Action

Change the id_alias to a default value and reissue the command.

CMMVC6107E x io_grp objects in target cluster; y are required**Explanation**

The number of I/O groups in the target cluster is not sufficient to accommodate the I/O groups defined in the backup configuration file. Determine why there are not enough I/O groups.

Action

Correct the problem and reissue the command.

CMMVC6108I Disk controller system with a WWN of wwnn found.**Explanation**

A disk controller system has been found with the required WWNN.

Action

Not applicable.

CMMVC6109E Disk controller system with a WWN of wwnn not available.**Explanation**

A disk controller system has been found with the required WWNN. Ensure that the required disk controller system is available to the cluster.

Action

Ensure that the required disk controller system is available to the cluster and reissue the command.

CMMVC6110E Bad code level**Explanation**

An unexpected error occurred.

Action

Report the details to the support center.

CMMVC6111E Cluster code_level could not be determined from level**Explanation**

The code level of the cluster could not be determined. The code level should be of the form, x.y.z, where x, y, and z are integers.

Action

If the cause of the problem cannot be determined, contact the support center.

CMMVC6112W object-type object-name has a default name**Explanation**

An object in the cluster has a default name. This can cause problems when restoring a cluster as default names are changed during restoration. Object IDs are also changed during restoration.

Action

Choose an appropriate name for each object in the cluster and reissue the command.

CMMVC6113E Command failed with return code: details**Explanation**

An attempt to run a command remotely failed using secure communications.

Action

Determine the cause of the problem and reissue the command.

CMMVC6114E No help for action action.**Explanation**

There is no help for the requested topic.

Action

Not applicable.

CMMVC6115W Feature property mismatch: value1 expected; value2 found**Explanation**

The features in the backup configuration file and the target cluster do not match. There should be an exact match between the two. Nevertheless, the restore of the configuration can continue.

Action

Not applicable.

CMMVC6116I Feature match or property**Explanation**

The features in the backup configuration file and the target cluster are an exact match.

Action

Not applicable.

CMMVC6117E fix-or-feature is not available**Explanation**

An unexpected error occurred.

Action

Contact the support center.

CMMVC6118I type with property value [and property value] found**Explanation**

An object in the cluster has been found with the correct properties.

Action

Not applicable.

CMMVC6119E type with property value [and property value] not found**Explanation**

An object in the cluster with the correct properties has not been found. Restoration cannot proceed without the object.

Action

Determine why the object cannot be found. Ensure that the object is available and reissue the command.

CMMVC6120E Target is not the configuration node**Explanation**

The target is not the configuration node.

Action

Redirect the action against the configuration node and reissue the command.

CMMVC6121E No cluster id or id_alias in backup configuration**Explanation**

Neither the cluster id_alias or ID can be extracted from the backup configuration file.

Action

If the cause of the problem cannot be determined, contact the support center.

CMMVC6122E No type with property value present in table**Explanation**

An unexpected error occurred.

Action

Contact the support center.

CMMVC6123E No property for type name**Explanation**

An unexpected error occurred.

Action

Contact the support center.

CMMVC6124E No type with property value**Explanation**

An unexpected error occurred.

Action

Contact the support center.

CMMVC6125E No unique ID for type name**Explanation**

An unexpected error occurred.

Action

Contact the support center.

CMMVC6126E No type with unique ID value**Explanation**

An unexpected error occurred.

Action

Contact the support center.

CMMVC6127I SSH key identifier for user already defined; will not be restored**Explanation**

An identical SSH key for this user is already defined on the cluster. Therefore, the key in the backup file will not be restored.

Action

Specify a different SSH key and reissue the command.

CMMVC6128W details

Explanation

The files in the directory could not be listed.

Action

Determine why they could not be listed and correct the problem and reissue the command.

CMMVC6129E vdisk-to-host map objects have vdisk_UID values that are not consistent

Explanation

All of the VDisk-to-host map objects do not have the same number for the VDisk LUN instance. Therefore, there is a possibility the backup configuration file is corrupt. The LUN instance number should be the same for all VDisk-to-host map objects that are associated with a specific VDisk. The LUN instance number is incorporated into the VDisk_UID property.

Action

Determine why the LUN instance number is not the same and correct the problem and reissue the command.

CMMVC6130W Inter-cluster property will not be restored

Explanation

The restoration of inter-cluster objects is not supported.

Action

Not applicable.

CMMVC6131E No location cluster information

Explanation

An unexpected error occurred.

Action

Contact the support center.

CMMVC6132E An object of a given type has a property with an incorrect value. The operation cannot proceed until the property has the correct value. Take administrative action to change the value and try again.

Explanation

An object has a property with an incorrect value. The property most likely reflects the state of the object.

Action

Change the state to the required value and reissue the command.

CMMVC6133E Required type property property not found

Explanation

An unexpected error occurred.

Action

Contact the support center.

CMMVC6134E No argument for -option

Explanation

No argument has been supplied for an option that requires an argument.

Action

Supply an argument and reissue the command.

CMMVC6135E Argument value for -option is not valid

Explanation

An argument has been supplied for an option that is not valid.

Action

Supply an valid argument and try again.

CMMVC6136W No SSH key file file-name

Explanation

A file that contains an SSH key is not present and will not be restored. The backup operation will continue.

Action

No action is required. You might have to manually restore the key.

CMMVC6137W No SSH key file file-name; key not restored**Explanation**

An SSH key cannot be restored because the file containing it is not present. The restore operation will continue.

Action

After the restore is complete, locate the file containing the key, and perform one of the following actions: (1) Rename the file so that it has the correct name and reissue the command. (2) Restore the key manually using the `svctask addsshkey` command.

CMMVC6138E -option is required**Explanation**

An option is missing. The option might be listed as optional, but circumstances make the option mandatory.

Action

Supply the option and reissue the command.

CMMVC6139E Incorrect XML tag nesting in filename**Explanation**

There is a problem with the content of a configuration file. There is a problem parsing the XML in the file, because the XML records are not consistent. The file might be corrupt or has been truncated.

Action

Replace this copy with a good copy and try again. If the problem persists, Contact the support center.

CMMVC6140E No default name for type type**Explanation**

An unexpected error occurred.

Action

Contact the support center.

CMMVC6141E -option does not contain any argument**Explanation**

An argument has been supplied for an option that does not contain any.

Action

Remove the argument and reissue the command.

CMMVC6142E Existing object-type object-name has a non-default name

Explanation

An object in the target default cluster has a non-default name. This suggests that the cluster was customized. The cluster is therefore not suitable for restoration.

Action

Reset the cluster as per the instructions for restoring the cluster configuration, and try again.

CMMVC6143E Required configuration file file-name does not exist

Explanation

A file is missing that is critical for successful operation.

Action

Not applicable.

CMMVC6144W Object with default name name restored as substitute-name

Explanation

An object with a default name has been restored with a different name. Ensure that you account for this name change when using the restored cluster in the future. To avoid this problem in the future, choose an appropriate name for each object in the cluster.

Action

Choose an appropriate name for each object in the cluster.

CMMVC6145I Use the restore -prepare command first

Explanation

This advisory is given prior to CMMVC6103E when an intermediate file is missing, presumed not created.

Action

Not applicable.

CMMVC6146E Problem parsing object-type data: line**Explanation**

An unexpected error occurred.

Action

Contact the support center.

CMMVC6147E type name has a name beginning with prefix**Explanation**

An object has been encountered that has a name beginning with a reserved prefix. The only valid reason for an object with this kind of name is: a restoration command did not complete successfully.

Action

Ensure that no objects use the reserved prefix in their name, and reissue the command.

CMMVC6148E Target cluster has n-actual objects of type type instead of n-required**Explanation**

The target cluster does not have the required number of certain types of objects.

Action

Correct the problem and reissue the command.

CMMVC6149E An action is required**Explanation**

An action is required to run the command.

Action

Supply an action, and reissue the command.

CMMVC6150E The action, action, is not valid**Explanation**

An action has been supplied that is not valid.

Action

Supply a valid action, and reissue the command.

CMMVC6151E The -option option is not valid**Explanation**

An option has been supplied that is not valid.

Action

Supply a valid action, and reissue the command.

CMMVC6152E vdisk name instance number instance is not valid**Explanation**

The VDisk could not be restored because the instance number (in hex) is not valid.

Action

Contact the support center.

CMMVC6153E object not consistent with action**Explanation**

The specified object is not supported for the action.

Action

Remove the object and reissue the command.

CMMVC6154E Required object-type property property-name has a null value**Explanation**

An unexpected error occurred.

Action

Contact the support center.

CMMVC6155I SVCCONFIG processing completed successfully**Explanation**

Only information and warning messages are issued.

Action

Not applicable.

CMMVC6156W SVCCONFIG processing completed with errors**Explanation**

Processing was not successful.

Action

Not applicable.

CMMVC6164E The SVCCONFIG CRON job, which runs overnight on a daily overnight, has failed.**Explanation**

The SVCCONFIG CRON job, which runs overnight on a daily overnight, has failed.

Action

Resolve any hardware and configuration problems that you are experiencing on the 2145 cluster. If the problem reoccurs contact the software support center for assistance.

CMMVC6165E Target is not the original configuration node with WNN of value.**Explanation**

A backup configuration can only be restored to the original configuration node.

Action

Recreate the default cluster with the correct configuration node, and reissue the command.

CMMVC6166E A property of an object has changed during svconfig restore -execute.**Explanation**

The integrity of the restoration cannot be guaranteed.

Action

Reissue the command from svconfig restore -prepare.

CMMVC6181E The target cluster contains an object that has a counterpart in the configuration to be restored, and has the correct ID.

Explanation

The indicated property has an unexpected value.

Action

Check that the correct (matching) backup configuration file (svc.config.backup.xml) is being provided and if it is, use the -force option to ignore the discrepancy. Otherwise, provide the correct file and try again.

CMMVC6182W An object that does not contribute to the fabric of the configuration cannot be restored because its configuration does not permit it to be created.

Explanation

An object that does not contribute to the fabric of the configuration cannot be restored because its configuration does not permit it to be created. For example, a host can only be created if it has at least one port.

Action

N/A

CMMVC6186W An IO group was restored with a different ID value.

Explanation

This can occur when the configuration node is different to the one used to create the original cluster. This affects the SCSI Inquiry value for the IO group.

Action

N/A

CMMVC6200E The action failed because of incompatible software.

Explanation

The software version on one or more nodes is incompatible with the new version.

Action

Refer to the compatibility requirements for the software version you are adding. Update the cluster to meet the compatibility requirements, and then perform the upgrade.

CMMVC6201E The node could not be added, because of incompatible software: status code *STATUS_CODE*

Explanation

The node could not be added, because of incompatible software.

Action

Upgrade the software on the node that has been rejected to the same level of software as the cluster to which it will be added, and resubmit the command.

CMMVC6202E The cluster was not modified because the IP address is not valid.

Explanation

An attempt was made to change the IP address of a cluster to an invalid address.

Action

Correct the address and re-issue the command.

CMMVC6203E The action failed because the directory that was specified was not one of the following directories: /dumps, /dumps/iostats, /dumps/iotrace, /dumps/feature, /dumps/config, /dumps/elogs, /dumps/ec or /dumps/pl.

Explanation

An attempt was made to clear a file from, or copy a file to, an invalid directory.

Action

Ensure that the command accesses a valid directory.

CMMVC6204E The action failed as the resulting disk size would be less than, or equal to, zero.

Explanation

An attempt was made to shrink a disk, however the resulting size would have been less than or equal to zero.

Action

Not applicable

CMMVC6205E Metadata recovery can not use the provided mdisk id - invalid or destroyed.

Explanation

Metadata recovery can not use the provided mdisk id - invalid or destroyed.

CMMVC6206E The software upgrade failed as a file containing the software for the specified MCP version was not found.

Explanation

There are two files required to successfully complete a software upgrade. One file contains the files that make up the base operating system, and the other file contains the 2145 software. This message appears if the OS version is incompatible with the 2145 software.

Action

Upload two compatible files and reissue the command.

CMMVC6207E The action failed because the virtual disk (VDisk) is part of a Metro Mirror mapping.

Explanation

An action was performed against a VDisk that is part of a Metro Mirror mapping.

Action

Remove the VDisk from the Metro Mirror mapping before re-issuing the command.

CMMVC6208E The action failed because the virtual disk (VDisk) is part of a FlashCopy mapping.

Explanation

An action was performed against a VDisk that is part of a FlashCopy mapping.

Action

Remove the VDisk from the FlashCopy mapping before re-issuing the command.

CMMVC6209E The FlashCopy mapping or consistency group could not be started in a reasonable time. The mapping or group is instead being prepared.

Explanation

The FlashCopy mapping or consistency group could not be started in a reasonable time. The mapping or group is instead being prepared.

Action

Resubmit the command.

CMMVC6210E The command failed as a result of a migrated disk IO medium error.

Explanation

The command failed as a result of a migrated disk IO medium error.

CMMVC6211E The command failed as a migrate to image was in progress.

Explanation

An attempt was made to execute a command against a VDisk that was involved in a migrate to image operation.

Action

Wait for the migration to complete and re-issue the command.

CMMVC6212E The command failed because data in the cache has not been committed to disk.

Explanation

The command failed because data in the cache has not been committed to disk.

CMMVC6213E You are trying to recover region data that was created by a code level different from the one you are currently running on the node.

Explanation

You are trying to recover region data that was created by a code level different from the one you are currently running on the node.

CMMVC6214E Failed to recreate the cluster you are trying to rebuild.

Explanation

Failed to recreate the cluster you are trying to rebuild.

CMMVC6215E The FlashCopy mapping was not created or modified because the consistency group already contains the maximum number of mappings.

Explanation

An attempt was made to create a FlashCopy mapping in, or move a FlashCopy mapping to, a consistency group that has the maximum number of FlashCopy mappings that it can contain.

Action

Create or move the FlashCopy mapping in another consistency group or remove an existing FlashCopy mapping from the desired group and then re-issue the command.

CMMVC6216E The Metro Mirror relationship was not created because the master or auxiliary virtual disk (VDisk) is a member of a Metro Mirror mapping.

Explanation

The Metro Mirror relationship was not created because the master or auxiliary virtual disk (VDisk) is a member of a Metro Mirror mapping.

Action

Select a different VDisk to make up the mapping.

CMMVC6217E The maximum number of hosts for the cluster is already configured.

Explanation

You must remove at least one host definition before you can resubmit the command.

Action

Determine whether the action is required.

If the action is required, review the current configuration to determine whether any current host definitions are not required. Remove at least one host definition that is not required, and resubmit the command.

CMMVC6218E The maximum number of host/IO group pairs for the cluster is already configured.

Explanation

You must remove at least one host/IO group pair definition before you can resubmit the command.

Action

Determine whether the action is required.

If the action is required, review the current configuration to determine whether any current host/IO group pair definitions are not required. Remove at least one host/IO group pair definition that is not required, and resubmit the command.

CMMVC6219E The maximum number of WPNs for the cluster is already configured.

Explanation

You must remove at least one WWPN definition before you can resubmit the command.

Action

Determine whether the action is required.

If the action is required, review the current configuration to determine whether any current WWPN definitions are not required. Remove at least one WWPN definition that is not required, and resubmit the command.

CMMVC6220E The maximum number of hosts for one or more IO groups is already configured.

Explanation

You must remove at least one host/IO group pair definition from the I/O group that you have specified before you can resubmit the command.

Action

Determine whether the action is required.

If the action is required, review the current configuration to determine whether any current host/IO group pair definitions for the I/O group that you have specified are not required. Remove at least one host/IO group pair definition that is not required from the I/O group that you have specified, and resubmit the command.

CMMVC6221E The maximum number of WPNs for one or more IO groups is already configured.

Explanation

You must remove at least one WWPN definition from the I/O group that you have specified before you can resubmit the command.

Action

Determine whether the action is required.

If the action is required, review the current configuration to determine whether any current WWPN definitions for the I/O group that you have specified are not required. Remove at least one WWPN definition that is not required from the I/O group that you have specified, and resubmit the command.

CMMVC6222E The maximum number of WWPNs for the host is already configured.

Explanation

You must remove at least one WWPN definition for the host that you have specified before you can resubmit the command.

Action

Determine whether the action is required.

If the action is required, review the current configuration to determine whether any current WWPN definitions for the host that you have specified are not required. Remove at least one WWPN definition that is not required for the host that you have specified, and resubmit the command.

CMMVC6223E The host does not belong to one or more of the IO groups specified or inferred.

Explanation

The host does not belong to one or more of the IO groups specified or inferred.

Action

Specify a host/IO group combination that is currently defined, and resubmit the command.

CMMVC6224E The host already belongs to one or more of the IO groups specified.

Explanation

The host already belongs to one or more of the IO groups specified.

Action

None.

CMMVC6225E An IO group cannot be removed from a host because of one or more associated vdisks.

Explanation

An IO group cannot be removed from a host because of one or more associated vdisks.

CMMVC6226E The action was not completed because the cluster has reached the maximum number of extents in MDisk Groups.

Explanation

The cluster has reached the maximum number of extents in the MDisk Group, therefore, the action did not complete.

Action

Select a different cluster and reissue the command.

CMMVC6227I The package installed successfully.

Explanation

The package installed successfully.

Action

None.

CMMVC6228E The cluster was recovered and the CLI functionality is limited until the cause of the failure is determined and any corrective action taken.

Explanation

The cluster was recovered and the CLI functionality is limited.

Action

Contact the support center.

CMMVC6229E The action failed as the SSH key has been revoked.

Explanation

The action failed as the SSH key has been revoked.

CMMVC6230E The action failed as the SSH key index (SSH_LABEL_ID) is invalid.

Explanation

The action failed as the SSH key index (SSH_LABEL_ID) is invalid.

CMMVC6231E The action failed as the audit table is full.

Explanation

The action failed as the audit table is full.

Action

Save the audit log to disk, and resubmit the command.

CMMVC6232E This operation cannot be performed because the cluster is currently aborting the previous software upgrade command.

Explanation

This operation cannot be performed because the cluster is currently aborting the previous software upgrade command.

Action

Wait until the previous software upgrade command has aborted successfully, and resubmit the command.

CMMVC6233E This operation cannot be performed because, either a software upgrade has not been started, or a software upgrade is in progress but is not in a state where it can be aborted.

Explanation

This operation cannot be performed because the software upgrade is making progress.

CMMVC6234E The upgrade cannot be aborted because at least one node has already committed to a new code level.

Explanation

The upgrade cannot be aborted because at least one node has already committed to a new code level.

CMMVC6235E An invalid response has been entered. The command has not been executed. Input is case sensitive. Enter either yes or no.

Explanation

An invalid response has been entered. The command has not been executed. Enter either yes or no.

Action

Enter either yes or no.

CMMVC6236E The command has not completed. A limited availability parameter has been entered without the required environment setting being set.

Explanation

The command has not completed. A limited availability parameter has been entered without the required environment setting being set.

CMMVC6237E The command failed as the remote cluster does not support global mirror.

Explanation

The command failed as the remote cluster does not support global mirror.

CMMVC6238E The copy type differs from other copies already in the consistency group.

Explanation

The copy type differs from other copies already in the consistency group.

Action

Ensure that the copy type of the mapping that you are attempting to add is the same copy type as the mappings in the consistency group to which you are attempting to add the mapping, and resubmit the command.

CMMVC6239E The FlashCopy mapping was not prepared because the mapping or consistency group is in the stopping state.

Explanation

You cannot prepare a FlashCopy mapping or consistency group when the FlashCopy mapping or consistency group is in the stopping state. If you want to prepare a FlashCopy mapping or consistency group, the FlashCopy mapping or consistency group must be in the Stopped or Idle_Copied state.

Action

Wait until the FlashCopy mapping or consistency group reaches the Stopped or Idle_Copied state and then resubmit the command.

CMMVC6240E The properties of the FlashCopy mapping were not modified because the mapping or consistency group is in the stopping state.

Explanation

You cannot modify the consistency group of a FlashCopy mapping when the FlashCopy mapping is in the stopping state. If you want to modify the consistency

group of a FlashCopy mapping, the FlashCopy mapping must be in the Stopped or Idle_Copied state.

Action

Wait until the FlashCopy mapping reaches the Stopped or Idle_Copied state and then resubmit the command.

CMMVC6241E The FlashCopy mapping was not deleted because the mapping or consistency group is in the stopping state. The mapping or consistency group must be stopped first.

Explanation

You cannot delete a FlashCopy mapping or consistency group when the FlashCopy mapping or consistency group is in the stopping state. If you want to delete a FlashCopy mapping or consistency group, the FlashCopy mapping or consistency group must be in the Stopped or Idle_Copied state.

Action

Wait until the FlashCopy mapping or consistency group reaches the Stopped or Idle_Copied state and then resubmit the command.

CMMVC6242E The FlashCopy mapping or consistency group was not started because the mapping or consistency group is in the stopping state.

Explanation

You cannot start a FlashCopy mapping or consistency group when the FlashCopy mapping or consistency group is in the stopping state. If you want to start a FlashCopy mapping or consistency group, the FlashCopy mapping or consistency group must be in the Prepared state.

Action

Wait until the FlashCopy mapping or consistency group reaches the Stopped or Idle_Copied state and then prepare the FlashCopy mapping or consistency group before starting it.

CMMVC6243E The FlashCopy mapping or consistency group was not stopped because the mapping or consistency group is already in the stopping state.

Explanation

A Stop FlashCopy mapping or consistency group task has already been submitted and is still in progress. When the task has completed successfully, the FlashCopy mapping or consistency group state will change to Stopped.

Action

None.

CMMVC6244E The FlashCopy mapping was not created because the source virtual disk (VDisk) cannot be the target for a FlashCopy mapping.

Explanation

A VDisk cannot simultaneously be both the source of a FlashCopy mapping and the target of a FlashCopy mapping. The source VDisk that you have specified is currently defined as the target of a FlashCopy mapping.

Action

You have two options. One option is specify a different source VDisk and resubmit the command. The other option is delete the existing FlashCopy mapping that defines the source VDisk that you have specified as the target VDisk, and resubmit the command.

CMMVC6245E The FlashCopy mapping was not created because the source virtual disk (VDisk) is already in the maximum number of FlashCopy mappings.

Explanation

The number of FlashCopy mappings in which a Vdisk can be defined as the source Vdisk is limited. The source Vdisk that you have specified cannot be defined to another FlashCopy mapping because it is already defined as the source Vdisk to the maximum number of FlashCopy mappings.

Action

You have two options. One option is specify a different source VDisk and resubmit the command. The other option is delete one of the existing FlashCopy mappings that contains the source VDisk and resubmit the command.

CMMVC6246E The FlashCopy mapping was not created because the target virtual disk (VDisk) is already a source vdisk in a FlashCopy mapping.

Explanation

A VDisk cannot simultaneously be both the source of a FlashCopy mapping and the target of a FlashCopy mapping. The target VDisk that you have specified is currently defined as the source of a FlashCopy mapping.

Action

You have two options. One option is specify a different target VDisk and resubmit the command. The other option is delete all of the existing FlashCopy mappings that contain the target VDisk that you have specified and resubmit the command.

CMMVC6247E The FlashCopy mapping was not created because the target virtual disk (VDisk) is already a target vdisk in a FlashCopy mapping.

Explanation

A VDisk cannot simultaneously be the target of more than one FlashCopy mapping. The target VDisk that you have specified is currently defined as the target of another FlashCopy mapping.

Action

You have two options. One option is specify a different target VDisk and resubmit the command. The other option is delete the existing FlashCopy mapping that contains the target VDisk that you have specified and resubmit the command.

CMMVC6248E The command failed because the authorization table is full.

Explanation

The command failed because the authorization table is full.

CMMVC6249E The command failed because the authorization record was not found or is already set to the default role.

Explanation

The command failed because the authorization record was not found or is already set to the default role.

CMMVC6250E The command failed because the authorization record is not set to the default role. Use rmauth to set the default role.

Explanation

The command failed because the authorization record is not set to the default role.

Action

Use rmauth to set the default role.

CMMVC6251E The command failed because the specified role was not found.

Explanation

The command failed because the specified role was not found.

CMMVC6252E The command failed authorization because the session ssh key is invalid or was deleted.

Explanation

The command failed authorization because the session ssh key is invalid or was deleted.

CMMVC6253E The command failed authorization because the session ssh key does not have the requisite role.

Explanation

The command failed authorization because the session ssh key does not have the requisite role.

CMMVC6254E The command failed because the specified ssh key was not found. NOTE This command must specify an admin key.

Explanation

The command failed because the specified ssh key was not found. NOTE This command must specify an admin key.

CMMVC6255E The command can not set the authorization record to the default role. Use rmauth to set the default role.

Explanation

The command can not set the authorization record to the default role.

Action

Use rmauth to set the default role.

CMMVC6263E The command failed because the ssh key already exists or there is a duplicate ssh key.

Explanation

You have attempted to add an ssh key that already exists, and may have a different authorization level associated with it.

Action

Add a different ssh key if the existing ssh key of the same type does not have the authority level that you require.

CMMVC6500E The action failed because the source and destination vdisk are the same.

Explanation

The action failed because the source and destination vdisk are the same.

CMMVC6501E The action failed because the node hardware is incompatible with the current I/O group member.

Explanation

The action failed because the node hardware is incompatible with the current I/O group member.

CMMVC6502E The FlashCopy mapping was not prepared because preparing consistency group 0 is not a valid operation.

Explanation

The FlashCopy mapping was not prepared because preparing consistency group 0 is not a valid operation.

CMMVC6503E The FlashCopy mapping or consistency group was not stopped because starting consistency group 0 is not a valid operation.

Explanation

The FlashCopy mapping or consistency group was not stopped because starting consistency group 0 is not a valid operation.

Accessibility

Accessibility features help a user who has a physical disability, such as restricted mobility or limited vision, to use software products successfully.

Features

These are the major accessibility features in the SAN Volume Controller Console :

- You can use screen-reader software and a digital speech synthesizer to hear what is displayed on the screen. The following screen readers have been tested: JAWS v4.5 and IBM Home Page Reader v3.0.
- You can operate all features using the keyboard instead of the mouse.

Navigating by keyboard

You can use keys or key combinations to perform operations and initiate many menu actions that can also be done through mouse actions. You can navigate the SAN Volume Controller Console and help system from the keyboard by using the following key combinations:

- To traverse to the next link, button, or topic, press Tab inside a frame (page).
- To expand or collapse a tree node, press → or ←, respectively.
- To move to the next topic node, press V or Tab.
- To move to the previous topic node, press ^ or Shift+Tab.
- To scroll all the way up or down, press Home or End, respectively.
- To go back, press Alt+←.
- To go forward, press Alt+→.
- To go to the next frame, press Ctrl+Tab.
- To move to the previous frame, press Shift+Ctrl+Tab.
- To print the current page or active frame, press Ctrl+P.
- To select, press Enter.

Accessing the publications

You can view the publications for the SAN Volume Controller in Adobe Portable Document Format (PDF) using the Adobe Acrobat Reader. The PDFs are provided at the following Web site:

<http://www.ibm.com/storage/support/2145>

Related reference

“SAN Volume Controller library and related publications” on page xxii
A list of other publications that are related to this product are provided to you for your reference.

Notices

This information was developed for products and services offered in the U.S.A.

IBM may not offer the products, services, or features discussed in this document in other countries. Consult your local IBM representative for information on the products and services currently available in your area. Any reference to an IBM product, program, or service is not intended to state or imply that only that IBM product, program, or service may be used. Any functionally equivalent product, program, or service that does not infringe any IBM intellectual property right may be used instead. However, it is the user's responsibility to evaluate and verify the operation of any non-IBM product, program, or service.

IBM may have patents or pending patent applications covering subject matter described in this document. The furnishing of this document does not give you any license to these patents. You can send license inquiries, in writing, to:

*IBM Director of Licensing
IBM Corporation
North Castle Drive
Armonk, NY 10504-1785
U.S.A.*

For license inquiries regarding double-byte (DBCS) information, contact the IBM Intellectual Property Department in your country or send inquiries, in writing, to:

*IBM World Trade Asia Corporation
Licensing
2-31 Roppongi 3-chome, Minato-ku
Tokyo 106-0032, Japan*

The following paragraph does not apply to the United Kingdom or any other country where such provisions are inconsistent with local law:

INTERNATIONAL BUSINESS MACHINES CORPORATION PROVIDES THIS PUBLICATIONS "AS IS" WITHOUT WARRANTY OF ANY KIND, EITHER EXPRESS OR IMPLIED, INCLUDING, BUT NOT LIMITED TO, THE IMPLIED WARRANTIES OF NON-INFRINGEMENT, MERCHANTABILITY OR FITNESS FOR A PARTICULAR PURPOSE. Some states do not allow disclaimer of express or implied warranties in certain transactions, therefore, this statement may not apply to you.

This information could include technical inaccuracies or typographical errors. Changes are periodically made to the information herein; these changes will be incorporated in new editions of the publication. IBM may make improvements and/or changes in the product(s) and/or the program(s) described in this publication at any time without notice.

Any references in this information to non-IBM Web sites are provided for convenience only and do not in any manner serve as an endorsement of those Web sites. The materials at those Web sites are not part of the materials for this IBM product and use of those Web sites is at your own risk.

IBM may use or distribute any of the information you supply in any way it believes appropriate without incurring any obligation to you.

Licensees of this program who wish to have information about it for the purpose of enabling: (i) the exchange of information between independently created programs and other programs (including this one) and (ii) the mutual use of the information which has been exchanged, should contact:

*IBM Corporation
Almaden Research
650 Harry Road
Bldg 80, D3-304, Department 277
San Jose, CA 95120-6099
U.S.A.*

Such information may be available, subject to appropriate terms and conditions, including in some cases, payment of a fee.

The licensed program described in this document and all licensed material available for it are provided by IBM under terms of the IBM Customer Agreement, IBM International Program License Agreement or any equivalent agreement between us.

Any performance data contained herein was determined in a controlled environment. Therefore, the results obtained in other operating environments may vary significantly. Some measurements may have been made on development-level systems and there is no guarantee that these measurements will be the same on generally available systems. Furthermore, some measurement may have been estimated through extrapolation. Actual results may vary. Users of this document may verify the applicable data for their specific environment.

Information concerning non-IBM products was obtained from the suppliers of those products, their published announcements or other publicly available sources. IBM has not tested those products and cannot confirm the accuracy of performance, compatibility or any other claims related to non-IBM products. Questions on the capabilities of non-IBM products may be addressed to the suppliers of those products.

All statements regarding IBM's future direction or intent are subject to change or withdrawal without notice, and represent goals and objectives only.

This information is for planning purposes only. The information herein is subject to change before the products described become available.

This information contains examples of data and reports used in daily business operations. To illustrate them as completely as possible, the examples include the names of individuals, companies, brands, and products. All of these names are fictitious and any similarity to the names and addresses used by an actual business enterprise is entirely coincidental.

If you are viewing this information softcopy, the photographs and color illustrations may not appear.

Trademarks

The following terms are trademarks of the International Business Machines Corporation in the United States, other countries, or both:

- AIX
- BladeCenter
- Enterprise Storage Server
- FlashCopy
- IBM
- IBM eServer
- IBM TotalStorage
- IBM System Storage
- System p5
- System z9
- System Storage
- TotalStorage
- xSeries

Intel and Pentium are trademarks of Intel Corporation in the United States, other countries, or both.

Java and all Java-based trademarks are trademarks of Sun Microsystems, Inc. in the United States, other countries, or both.

Microsoft and Windows are trademarks of Microsoft Corporation in the United States, other countries, or both.

UNIX is a registered trademark of The Open Group in the United States and other countries.

Linux is a trademark of Linus Torvalds in the United States, other countries, or both.

Adobe, Acrobat, Portable Document Format (PDF), and PostScript are either registered trademarks or trademarks of Adobe Systems Incorporated in the United States, other countries, or both.

Other company, product, and service names may be trademarks or service marks of others.

Glossary

This is the glossary for the SAN Volume Controller.

A

application server

A host that is attached to the storage area network (SAN) and that runs applications.

asymmetric virtualization

A virtualization technique in which the virtualization engine is outside the data path and performs a metadata-style service. The metadata server contains all the mapping and locking tables while the storage devices contain only data. See also *symmetric virtualization*.

auxiliary virtual disk

The virtual disk that contains a backup copy of the data and that is used in disaster recovery scenarios. See also *master virtual disk*.

C

cluster

In SAN Volume Controller, a pair of nodes that provides a single configuration and service interface.

configuration node

A node that acts as the focal point for configuration commands and manages the data that describes the cluster configuration.

consistency group

A group of copy relationships between virtual disks that are managed as a single entity.

consistent copy

In a Metro or Global Mirror relationship, a copy of a secondary virtual disk (VDisk) that is identical to the primary VDisk from the viewpoint of a host system, even if a power failure occurred while I/O activity was in progress.

copied

In a FlashCopy mapping, a state that indicates that a copy has been started after the copy relationship was created. The copy process is complete and the target disk has no further dependence on the source disk.

copying

A status condition that describes the state of a pair of virtual disks (VDisks) that have a copy relationship. The copy process has been started but the two virtual disks are not yet synchronized.

counterpart SAN

A nonredundant portion of a redundant storage area network (SAN). A counterpart SAN provides all the connectivity of the redundant SAN but without the redundancy. Each counterpart SANs provides an alternate path for each SAN-attached device. See also *redundant SAN*.

D

data migration

The movement of data from one physical location to another without disrupting I/O operations.

degraded

Pertaining to a valid configuration that has suffered a failure but continues to be supported and legal. Typically, a repair action can be performed on a degraded configuration to restore it to a valid configuration.

dependent write operations

A set of write operations that must be applied in the correct order to maintain cross-volume consistency.

destage

A write command initiated by the cache to flush data to disk storage.

directed maintenance procedures

The set of maintenance procedures that can be run for a cluster. These procedures are run from within the SAN Volume Controller application and are documented in the *IBM System Storage SAN Volume Controller: Service Guide*.

disconnected

In a Metro or Global Mirror relationship, pertains to two clusters when they cannot communicate.

disk controller

A device that coordinates and controls the operation of one or more disk drives and synchronizes the operation of the drives with the operation of the system as a whole. Disk controllers provide the storage that the cluster detects as managed disks (MDisks).

disk zone

A zone defined in the storage area network (SAN) fabric in which the SAN Volume Controller can detect and address the logical units that the disk controllers present.

E

error code

A value that identifies an error condition.

ESS See *IBM TotalStorage[®] Enterprise Storage Server[®]*.

exclude

To remove a managed disk (MDisk) from a cluster because of certain error conditions.

excluded

In SAN Volume Controller, the status of a managed disk that the cluster has removed from use after repeated access errors.

extent A unit of data that manages the mapping of data between managed disks and virtual disks.

F

failover

In SAN Volume Controller, the function that occurs when one redundant part of the system takes over the workload of another part of the system that has failed.

fibre channel

A technology for transmitting data between computer devices at a data rate of up to 4 Gbps. It is especially suited for attaching computer servers to shared storage devices and for interconnecting storage controllers and drives.

FC See *fibre channel*.

FlashCopy service

In SAN Volume Controller, a copy service that duplicates the contents of a source virtual disk (VDisk) to a target VDisk. In the process, the original contents of the target VDisk are lost. See also *point-in-time copy*.

FlashCopy mapping

A relationship between two virtual disks.

FlashCopy relationship

See *FlashCopy mapping*.

G**Global Mirror**

An asynchronous copy service that enables host data on a particular source virtual disk (VDisk) to be copied to the target VDisk that is designated in the relationship.

H

HBA See *host bus adapter*.

host bus adapter (HBA)

In SAN Volume Controller, an interface card that connects a host bus, such as a peripheral component interconnect (PCI) bus, to the storage area network.

host An open-systems computer that is connected to the SAN Volume Controller through a fibre-channel interface.

host ID

In SAN Volume Controller, a numeric identifier assigned to a group of host fibre-channel ports for the purpose of logical unit number (LUN) mapping. For each host ID, there is a separate mapping of Small Computer System Interface (SCSI) IDs to virtual disks (VDisks).

host zone

A zone defined in the storage area network (SAN) fabric in which the hosts can address the SAN Volume Controllers.

I**IBM TotalStorage Enterprise Storage Server (ESS)**

An IBM product that provides an intelligent disk-storage subsystem across an enterprise.

idling

- The status of a pair of virtual disks (VDisks) that have a defined copy relationship for which no copy activity has yet been started.
- In a Metro or Global Mirror relationship, the state that indicates that the master virtual disks (VDisks) and auxiliary VDisks are operating in the primary role. Consequently, both VDisks are accessible for write I/O operations.

illegal configuration

A configuration that will not operate and will generate an error code to indicate the cause of the problem.

image mode

An access mode that establishes a one-to-one mapping of extents in the managed disk (MDisk) with the extents in the virtual disk (VDisk). See also *managed space mode* and *unconfigured mode*.

image VDisk

A virtual disk (VDisk) in which there is a direct block-for-block translation from the managed disk (MDisk) to the VDisk.

inconsistent

In a Metro or Global Mirror relationship, pertaining to a secondary virtual disk (VDisk) that is being synchronized with the primary VDisk.

input/output (I/O)

Pertaining to a functional unit or communication path involved in an input process, an output process, or both, concurrently or not, and to the data involved in such a process.

integrity

The ability of a system to either return only correct data or respond that it cannot return correct data.

Internet Protocol (IP)

In the Internet suite of protocols, a connectionless protocol that routes data through a network or interconnected networks and acts as an intermediary between the higher protocol layers and the physical network.

I/O See *input/output*.

I/O group

A collection of virtual disks (VDisks) and node relationships that present a common interface to host systems.

I/O throttling rate

The maximum rate at which an I/O transaction is accepted for this virtual disk (VDisk).

IP See *Internet Protocol*.

L

LBA See *logical block address*.

local fabric

In SAN Volume Controller, those storage area network (SAN) components (such as switches and cables) that connect the components (nodes, hosts, switches) of the local cluster together.

local/remote fabric interconnect

The storage area network (SAN) components that are used to connect the local and remote fabrics together.

logical block address (LBA)

The block number on a disk.

logical unit (LU)

An entity to which Small Computer System Interface (SCSI) commands are addressed, such as a virtual disk (VDisk) or managed disk (MDisk).

logical unit number (LUN)

The SCSI identifier of a logical unit within a target. (S)

LU See *logical unit*.

LUN See *logical unit number*.

M**managed disk (MDisk)**

A Small Computer System Interface (SCSI) logical unit that a redundant array of independent disks (RAID) controller provides and a cluster manages. The MDisk is not visible to host systems on the storage area network (SAN).

managed disk group

A collection of managed disks (MDisks) that, as a unit, contain all the data for a specified set of virtual disks (VDisks).

managed space mode

An access mode that enables virtualization functions to be performed. See also *image mode* and *unconfigured mode*.

mapping

See *FlashCopy mapping*.

master virtual disk

The virtual disk (VDisk) that contains a production copy of the data and that an application accesses. See also *auxiliary virtual disk*.

MDisk

See *managed disk*.

Metro Mirror

A synchronous copy service that enables host data on a particular source virtual disk (VDisk) to be copied to the target VDisk that is designated in the relationship.

migration

See *data migration*.

mirrorset

- IBM definition: See *RAID-1*.
- HP definition: A RAID storageset of two or more physical disks that maintain a complete and independent copy of the data from the virtual disk. This type of storageset has the advantage of being highly reliable and extremely tolerant of device failure. Raid level 1 storagesets are referred to as mirrorsets.

N

node One SAN Volume Controller. Each node provides virtualization, cache, and Copy Services to the storage area network (SAN).

node rescue

In SAN Volume Controller, the process by which a node that has no valid software installed on its hard disk drive can copy the software from another node connected to the same fibre-channel fabric.

O

offline

Pertaining to the operation of a functional unit or device that is not under the continual control of the system or of a host.

online Pertaining to the operation of a functional unit or device that is under the continual control of the system or of a host.

P

partnership

In Metro or Global Mirror, the relationship between two clusters. In a cluster partnership, one cluster is defined as the local cluster and the other cluster as the remote cluster.

paused

In SAN Volume Controller, the process by which the cache component quiesces all ongoing I/O activity below the cache layer.

pend To cause to wait for an event.

point-in-time copy

The instantaneous copy that the FlashCopy service makes of the source virtual disk (VDisk). In some contexts, this copy is known as a T_0 copy.

port The physical entity within a host, SAN Volume Controller, or disk controller system that performs the data communication (transmitting and receiving) over the fibre channel.

primary virtual disk

In a Metro or Global Mirror relationship, the target of write operations issued by the host application.

PuTTY

A client program that allows you to run remote sessions on your computer through specific network protocols, such as SSH, Telnet, and Rlogin.

Q

quorum disk

A managed disk (MDisk) that contains quorum data and that a cluster uses to break a tie and achieve a quorum.

R

RAID See *redundant array of independent disks*.

RAID 1

- SNIA dictionary definition: A form of storage array in which two or more identical copies of data are maintained on separate media.
- IBM definition: A form of storage array in which two or more identical copies of data are maintained on separate media. Also known as mirrorset.
- HP definition: See *mirrorset*.

RAID 5

- SNIA definition: A form of parity RAID in which the disks operate independently, the data strip size is no smaller than the exported block size, and parity check data is distributed across the array's disks. (S)
- IBM definition: See above.

- HP definition: A specially developed RAID storage set that stripes data and parity across three or more members in a disk array. A RAID set combines the best characteristics of RAID level 3 and RAID level 5. A RAID set is the best choice for most applications with small to medium I/O requests, unless the application is write intensive. A RAID set is sometimes called parity RAID. RAID level 3/5 storage sets are referred to as RAID sets.

RAID 10

A type of RAID that optimizes high performance while maintaining fault tolerance for up to two failed disk drives by striping volume data across several disk drives and mirroring the first set of disk drives on an identical set.

redundant array of independent disks

A collection of two or more disk drives that present the image of a single disk drive to the system. In the event of a single device failure, the data can be read or regenerated from the other disk drives in the array.

redundant SAN

A storage area network (SAN) configuration in which any one single component might fail, but connectivity between the devices within the SAN is maintained, possibly with degraded performance. This configuration is normally achieved by splitting the SAN into two, independent, counterpart SANs. See also *counterpart SAN*.

rejected

A status condition that describes a node that the cluster software has removed from the working set of nodes in the cluster.

relationship

In Metro or Global Mirror, the association between a master virtual disk (VDisk) and an auxiliary VDisk. These VDIs also have the attributes of a primary or secondary VDisk. See also *auxiliary virtual disk, master virtual disk, primary virtual disk, and secondary virtual disk*.

S

SAN See *storage area network*.

SAN Volume Controller fibre-channel port fan in

The number of hosts that can see any one SAN Volume Controller port.

SCSI See *Small Computer Systems Interface*.

secondary virtual disk

In Metro or Global Mirror, the virtual disk (VDisk) in a relationship that contains a copy of data written by the host application to the primary VDisk.

Secure Shell

A program to log in to another computer over a network, to execute commands in a remote machine, and to move files from one machine to another.

sequential VDisk

A virtual disk that uses extents from a single managed disk.

Simple Network Management Protocol (SNMP)

In the Internet suite of protocols, a network management protocol that is used to monitor routers and attached networks. SNMP is an

application-layer protocol. Information on devices managed is defined and stored in the application's Management Information Base (MIB).

Small Computer System Interface (SCSI)

A standard hardware interface that enables a variety of peripheral devices to communicate with one another.

SNMP

See *Simple Network Management Protocol*.

SSH See *Secure Shell*.

stand-alone relationship

In FlashCopy, Metro Mirror, and Global Mirror, relationships that do not belong to a consistency group and that have a null consistency group attribute.

stop A configuration command that is used to stop the activity for all copy relationships in a consistency group.

stopped

The status of a pair of virtual disks (VDisks) that have a copy relationship that the user has temporarily broken because of a problem.

storage area network (SAN)

A network whose primary purpose is the transfer of data between computer systems and storage elements and among storage elements. A SAN consists of a communication infrastructure, which provides physical connections, and a management layer, which organizes the connections, storage elements, and computer systems so that data transfer is secure and robust. (S)

subsystem device driver (SDD)

An IBM pseudo device driver designed to support the multipath configuration environments in IBM products.

superuser authority

The level of access required to add users.

suspended

The status of a pair of virtual disks (VDisks) that have a copy relationship that has been temporarily broken because of a problem.

symmetric virtualization

A virtualization technique in which the physical storage in the form of Redundant Array of Independent Disks (RAID) is split into smaller chunks of storage known as *extents*. These extents are then concatenated, using various policies, to make virtual disks (VDisks). See also *asymmetric virtualization*.

synchronized

In Metro or Global Mirror, the status condition that exists when both virtual disks (VDisks) of a pair that has a copy relationship contain the same data.

T

trigger

To initiate or reinitiate copying between a pair of virtual disks (VDisks) that have a copy relationship.

U

unconfigured mode

A mode in which I/O operations cannot be performed. See also *image mode* and *managed space mode*.

uninterruptible power supply (UPS)

A device connected between a computer and its power source that protects the computer against blackouts, brownouts, and power surges. The uninterruptible power supply contains a power sensor to monitor the supply and a battery to provide power until an orderly shutdown of the system can be performed.

V

valid configuration

A configuration that is supported.

VDisk See *virtual disk*.

virtual disk (VDisk)

In SAN Volume Controller, a device that host systems attached to the storage area network (SAN) recognize as a Small Computer System Interface (SCSI) disk.

virtualization

In the storage industry, a concept in which a pool of storage is created that contains several disk subsystems. The subsystems can be from various vendors. The pool can be split into virtual disks that are visible to the host systems that use them.

virtualized storage

Physical storage that has virtualization techniques applied to it by a virtualization engine.

vital product data (VPD)

Information that uniquely defines system, hardware, software, and microcode elements of a processing system.

W

worldwide node name (WWNN)

An identifier for an object that is globally unique. WWNNs are used by Fibre Channel and other standards.

worldwide port name (WWPN)

A unique 64-bit identifier associated with a fibre-channel adapter port. The WWPN is assigned in an implementation- and protocol-independent manner.

WWNN

See *worldwide node name*.

WWPN

See *worldwide port name*.

Index

Special characters

-filtervalue argument 173

A

about this guide xix
accessibility
 keyboard 429
 shortcut keys 429
administrator role 18
audience xix
audit log commands
 overview 11

B

backup and restore commands 59
book
 about this xix

C

CLI (command-line interface)
 configuring PuTTY 5
 preparing SSH client systems 2
CLI messages xxxvii
cluster
 commands 35
clusters
 diagnostic and service aid
 commands 65
command-line interface (CLI)
 configuring 4
 configuring PuTTY 5
 preparing SSH clients 2
commands
 addhostiogr 81
 addhostport 82
 addmdisk 109
 addnode 35, 65
 addsshkey 291
 applysoftware 67, 295
 backup 59
 catauditlog 11
 caterrlog 181
 caterrlogbyseqnum 183
 chcluster 38
 chcontroller 313
 chemail 24
 chemailuser 25
 cherrstate 69, 283
 chfconsistgrp 121
 chfcmmap 122
 chhost 83
 chiogr 41
 chlicense 287
 chmdisk 117
 chmdiskgrp 110
 chnode 41

commands (*continued*)
 chpartnership 139
 chrconsistgrp 140
 chrrelationship 141
 chvdisk 91
 clear 60
 cleardumps 42, 296
 clearerrlog 70, 282
 cpdumps 44
 detectmdisk 45
 dumpauditlog 13
 dumperrlog 70, 281, 298
 dumpinternallog 288
 e-mail commands
 overview 23
 e-mail notification overview 23
 exit 299
 expandvdisksize 94
 finderr 71, 281
 help 61
 includemdisk 118
 inventory commands
 overview 23
 inventory notification overview 23
 ls2145dumps 184, 301
 lsauditlogdumps 14
 lsauth 20
 lscluster 186
 lsclustercandidate 190
 lsclustervpd 302
 lscontroller 191
 lscopystatus 185
 lsdiscoverystatus 194
 lsemailuser 26
 lserrlogbyfconsistgrp 195
 lserrlogbyfcmmap 196
 lserrlogbyhost 198
 lserrlogbyiogrp 199
 lserrlogbymdisk 200
 lserrlogbymdiskgroup 202
 lserrlogbynnode 203
 lserrlogbyrcconsistgrp 205
 lserrlogbyrcrelationship 206
 lserrlogbyvdisk 208
 lserrlogdumps 209, 303
 lsfabric 210
 lsfconsistgrp 212
 lsfcmmap 214
 lsfcmmapcandidate 217
 lsfcmmapdependentmaps 219
 lsfcmmapprogress 218
 lsfeaturedumps 221, 304
 lsfreeextents 222
 lshbaportcandidate 223
 lshost 224
 lshostiogr 227
 lshostvdisksmap 228
 lsiogr 230
 lsiogrpcandidate 233
 lsiogrphost 232
 lsiostatsdumps 234, 305

commands (*continued*)
 lsiotracedumps 235, 306
 lslicense 236
 lsmdisk 237
 lsmdiskcandidate 241
 lsmdiskextent 243
 lsmdiskmember 247
 lsmigrate 249
 lsnodecandidate 253
 lsnodevpd 254, 308
 lsrconsistgrp 258
 lsrrelationship 260
 lsrrelationshipcandidate 263
 lsrrelationshipprogress 265
 lssoftwaredumps 266, 312
 lssshkeys 267
 lstimezones 268
 lsvdisk 269
 lsvdiskextent 272
 lsvdiskfcmappings 274
 lsvdiskhostmap 275
 lsvdiskmember 276
 lsvdiskprogress 278
 migrateexts 161
 migratetoimage 163
 migratevdisk 164
 mkauth 18
 mkemailuser 28
 mkfconsistgrp 123
 mkfcmmap 124
 mkhost 85
 mkmdiskgrp 111
 mkrconsistgrp 144
 mkrrelationship 145
 mkvdisk 96
 mkvdiskhostmap 101
nodes
 Copy Services 139
 Global Mirror 139
 Metro Mirror 139
prestartfconsistgrp 127, 132
prestartfcmmap 128
restore 62
rsmallsshkeys 292
rmauth 19
rmemailuser 29
rmfconsistgrp 129
rmfcmmap 130
rmhost 87
rmhostiogr 88
rmhostport 89
rmmdisk 112
rmmdiskgrp 114
rmnode 46, 72
rmpartnership 148
rmrconsistgrp 149
rmrrelationship 150
rmsshkey 293
rmvdisk 103
rmvdiskhostmap 105
sendinventoryemail 30

commands (*continued*)

- setclustertime 51
- setdisktrace 167
- setemail 31
- setevent 77, 284
- setlocale 78
- setpwdreset 52
- setquorum 118
- settimezone 53
- settrace 168
- showtimezone 279
- shrinkvdisksize 106
- startemail 32
- startfcmap 133
- startcrconsistgrp 151
- startcrrelationship 153
- startstats 54
- starttrace 170
- stopcluster 56
- stopemail 33
- stopfcconsistgrp 134
- stopfcmap 136
- stopcrconsistgrp 155
- stopcrrelationship 157
- stopstats 58
- stoptrace 171
- svqueryclock 79
- switchcrconsistgrp 158
- switchcrrelationship 159
- testemail 33
- writesernum 79

configuring

- command-line interface (CLI) 4
- master console 4
- PuTTY 5
- SAN Volume Controller Console 4
- secure shell (SSH) 4
- SSH (Secure Shell) 4

controllers

- command 191, 313

conventions xxii

copyoperator role 18

creating

- SSH keys 4

D

- data types xxx

- diagrams, syntax xxvi

dump files

- listing 184, 301

E

e-mail commands

- chemailuser 25
- mkemailuser 28
- setemail 31
- startemail 32
- stopemail 33
- testemail 33

e-Mail commands

- chemail 24
- lsemailuser 26
- rmemailuser 29

- emphasis in text xxii

F

filtering

- FlashCopy
 - consistency groups 212
 - mappings 214

- flags xxxvi

FlashCopy

- command 121

G

- generating an SSH key pair 4

Global Mirror

- commands 139
- stopcrrelationship 157
- switchcrconsistgrp 158
- switchcrrelationship 159

- glossary 435

guide

- about this xix
- who should read xix

H

hosts

- commands 81
- viewing 224

I

information

- commands 181

- information center xxii

installing

- PuTTY 1

inventory commands

- chcluster 38
- chemailuser 25
- mkemailuser 28
- rmemailuser 29
- sendinventoryemail 30
- startemail 32
- stopemail 33
- testemail 33

K

- keyboard 429

- keyboard shortcuts 429

L

- list dump commands

- overview 179

M

- managed disk (MDisk) groups

- viewing 245

- managed disks (MDisks)

- viewing 237

- master console

- configuring 4

- MDisk (managed disk) groups

- command 109

- MDisks (managed disks)

- command 117

messages

- CLI (command-line interface) 315

- Metro Mirror

- commands 139

- migration 161

- monitor role 19

N

nodes

- viewing 250, 307

notices

- legal 431

O

- ordering publications xxvi

overview

- SSH (secure shell) 9

P

preparing

- SSH client system

- overview 1

- to issue CLI commands 2

- public SSH keys

- storing 6

publications

- ordering xxvi

- PuTTY 5

- configuring 5

- generating an SSH key pair 4

- installing 1

- PuTTY scp

- overview 9

R

- related information xxii

Role based security commands

- lsauth 20

- mkauth 18

- overview 17

- rmauth 19

S

- SAN Volume Controller Console

- configuring 4

- SAN Volume Controller software

- copying using PuTTY scp 9

- secure shell (SSH) 3

- configuring 4

- overview 9

- Secure Shell (SSH)

- client system

- overview 1

- preparing to issue CLI

- commands 2

- creating keys 4

- Secure Shell (SSH) *(continued)*
 - key command 291
 - keys
 - adding 7
 - generating 4
 - storing 6
 - security
 - overview 3
 - service
 - mode
 - command 295
 - information command 301
 - shortcut keys 429
 - software
 - copying using PuTTY scp 9
 - SSH (secure shell) 3
 - SSH (Secure Shell)
 - client system
 - overview 1
 - preparing to issue CLI
 - commands 2
 - configuring 4
 - creating 4
 - keys
 - adding 7
 - generating 4
 - storing 6
 - SSH key pair
 - generating 4
 - storing
 - public SSH keys 6
 - summary of changes xix
 - support
 - Web sites xxv
 - syntax diagram
 - parameters xxxvi
 - syntax diagrams xxvi

T

- terminology xxviii
- text emphasis xxii
- tracing
 - commands 167, 281
- trademarks 433

V

- value ranges xxx
- VDisks (virtual disks)
 - commands 91
 - creating 96
 - viewing 269
 - viewing FlashCopy mappings 274
- viewing
 - clusters 186
 - featurization settings 287
 - Global Mirror
 - consistency groups 258
 - relationships 260
 - I/O groups 230
 - Metro Mirror
 - consistency groups 258
 - relationships 260

W

- Web sites xxv
- who should read this guide xix
- wildcards xxix

Readers' Comments — We'd Like to Hear from You

IBM System Storage SAN Volume Controller
Command-Line Interface User's Guide
Version 4.2.0

Publication No. SC26-7903-01

We appreciate your comments about this publication. Please comment on specific errors or omissions, accuracy, organization, subject matter, or completeness of this book. The comments you send should pertain to only the information in this manual or product and the way in which the information is presented.

For technical questions and information about products and prices, please contact your IBM branch office, your IBM business partner, or your authorized remarketer.

When you send comments to IBM, you grant IBM a nonexclusive right to use or distribute your comments in any way it believes appropriate without incurring any obligation to you. IBM or any other organizations will only use the personal information that you supply to contact you about the issues that you state on this form.

Comments:

Thank you for your support.

Submit your comments using one of these channels:

- Send your comments to the address on the reverse side of this form.

If you would like a response from IBM, please fill in the following information:

Name

Address

Company or Organization

Phone No.

E-mail address



Fold and Tape

Please do not staple

Fold and Tape



NO POSTAGE
NECESSARY
IF MAILED IN THE
UNITED STATES

BUSINESS REPLY MAIL

FIRST-CLASS MAIL PERMIT NO. 40 ARMONK, NEW YORK

POSTAGE WILL BE PAID BY ADDRESSEE

International Business Machines Corporation
Information Development
Department 61C
9032 South Rita Road
Tucson, Arizona 85755-4401



Fold and Tape

Please do not staple

Fold and Tape



Printed in USA

SC26-7903-01



Spine information:



IBM System Storage SAN Volume
Controller

Command-Line Interface User's Guide

Version 4.2.0